

THE WORLD'S LARGEST CATALOGUE
ESSENTIAL

PRESENT-DAY PROMOTIONAL PRODUCTS

2024

Gifts & Production
colors
كلرز جيفت
colors-pro.com

ZERO PROBLEMS

THE LARGEST STOCK



The mark of responsible forestry



**IMMERSE YOURSELF IN
THE EXCLUSIVE NEW
COLLECTION OF IDEAS
PREPARED FOR YOU.**

**EACH PRODUCT HAS BEEN
CAREFULLY CHOSEN TO
ENHANCE YOUR BRAND
AND CREATE A MEMORABLE
IMPACT.**

**FIND OUT HOW TO LET
YOUR BRAND STAND OUT IN
A UNIQUE WAY.**



+800 NOVELTIES

THE LARGEST COLLECTION OF
PROMOTIONAL PRODUCTS
IN THE MARKET







DISCOVER THE PERFECT FUSION OF DESIGN, INNOVATION, FUNCTIONALITY AND SUSTAINABILITY. FIND THE PERFECT GIFT IN THE LARGEST COLLECTION OF PROMOTIONAL ITEMS, AND CREATE A UNIQUE WAY TO DELIVER YOUR MESSAGE.

COMMITTED TO SUSTAINABILITY: NEW MATERIALS, PRODUCTS AND PACKAGING ARE CAREFULLY SELECTED FOR A MORE ENVIRONMENTALLY RESPONSIBLE FUTURE. EXPLORE THE SUSTAINABLE REVOLUTION THROUGH OUR OUTSTANDING CHOICES.



TECH GIFTS 06-107

Technologie / Technology / Technologie

TECH ACCESORIES 108-121Technisches Zubehör / Technology Accessories /
Technologie Accessoires**BUSSINESS & OFFICE** 122-171Büro Und Arbeit / Office And Business /
Kantoor En Bedrijf**NOTE THE IDEA!** 172-211Notizblöcke, Notizbücher Und Notizblockhalter/
Blocs And Notepads / Notitieblokken, Notebooks
En Notitieblokhouders**URBAN LIFESTYLE** 212-265Rucksäcke, Taschen Und Freizeit / Backpacks & Leisure /
Rugzakken, Tassen En Vrije Tijd**DRINKWARE** 266-323Dosen Und Flaschen / Bottles And
Thermos / Blikken En Flacons**MUGS & CUPS** 324-367Becher Und Tassen / Mugs And
Cups / Bekers En Tumblers**TO GO** 368-395

Take Away / Take Away / Om Mee Te Nemen

BAGS 396-435Taschen / Bags /
Tassen**LET'S WRITE** 436-503

Schreiben / Writing / Schrijven

SPORTS & FITNESS 504-531Sport Und Fitness / Sports And Fitness /
Sport En Fitness**OUTDOOR & PICNIC** 532-553Abenteuer Und Picknick / Adventure And
Picnic / Avontuur En Picknick**URBAN TRAVEL** 554-575

Reise / Travel / Reizen

DECO 576-587

Dekoration / Decoration / Decoratie

HOME ESSENTIALS 588-629

Home / Home / Home

BARWARE 630-673Wein-, Bar- Und Hotelaccessoires / Wine, Bar And Hotel
Accessories / Wijn, Bar En Hoteltoebehoren**GIFTS FOR ALL** 674-739Geschenke Und Preise / Gifts And Premiums /
Geschenken En Premies**PERSONAL CARE & WELLNESS** 740-785Persönliche Pflege Und Pharma / Personal Care And
Pharma / Persoonlijke Verzorging En Farmacie**LET'S PLAY** 786-833

Kinder / Kids / Kinderen

BEST FRIENDS 834-845Haustierprodukte / Pets Products /
Mascottes**AUTO** 846-861Autozubehör / Automotive Accessories
/ Autoaccessoires**TOOLS & DIY** 862-887Werkzeuge Und Heimwerkerbedarf / Tools, And Brico /
Gereedschappen En Baksteen**SPECIAL AGRICULTURE** 888-897

Garten/ Agriculture / Landbouw

HEADWEAR 898-927Kappen Und Hüte / Caps And Hats /
Petten En Mutsen**SUN & SUMMER** 928-977Sommer Und Strand / Summer And Beach/
Zomer En Strand**EVENTS** 978-999Events Und Partys / Events And Party /
Evenementen En Feesten**IT'S RAINING AGAIN!** 1000-1035

Regen Und Kälte / Rain And Cold / Regen En Kou

SUBLIMATION LINE 1036-1055

Sublimationslinie / Sublimation Line / Sublimatielijin

HANDLING & PACKAGING 1056-1069Spezielle Verpackungen / Special Packaging /
Speciale Verpakking**TEXTILE** 1070-1139

Textilien / Textile / Textiel

CHRISTMAS & SEASONAL 1140-1155

Weihnachten / Christmas / Kerstmis

UNIQUE OFFERS 1156-1215

Outlet

INDEX

** The prices published in this catalogue may change throughout 2024*** Die in diesem Katalog veröffentlichten Preise können im Laufe des Jahres 2024 variieren
* De gepubliceerde prijzen in deze catalogus kunnen in de loop van het jaar 2024 veranderen*

01 TECH GIFTS





NATURAL STONE



New



New



New

Lukater 21040 (15W) WIRELESS CHARGER

Charger: Natural Stone Extracts/ ABS. Wireless 15W.
Ladegerät: Natursteinextrakte/ ABS. Drahtlos 15W.
Chargeur: Extraits de Pierre Naturelle/ ABS. Sans Fil 15W.
Oplader: Extracten van Natuursteen/ ABS. Draadloos 15W.

Ø 10 x 1.3 cm 100 / 50 Print Code: E(4)

Noiman 21039

Power Bank. Natural Stone Extracts/ ABS. 5000 mAh. 2 USB Outputs. Type C Output and Input.
Power Bank. Natursteinextrakte/ ABS. 5000 mAh. 2 USB Ausgänge. Typ C Ausgänge und Eingang.
Power Bank. Extraits de Pierre Naturelle/ ABS. 5000 mAh. 2 Sorties USB. Sortie et Entrée Type C.
Power Bank. Extracten van Natuursteen/ ABS. 5000 mAh. 2 USB Outputs. Typ C Output en Input.

6.4 x 10.6 x 1.6 cm 50 / 25 Print Code: E(4), W

Nagent 21041



USB Hub. Natural Stone Extracts/ ABS. 1 Hub Type C. 2 Hubs USB 2.0.
USB Hub. Natursteinextrakte/ ABS. 1 Typ C Hub. 2 Hubs USB 2.0.
Port USB. Extraits de Pierre Naturelle/ ABS. 1 Port Type C. 2 Ports USB 2.0.
USB Hub. Extracten van Natuursteen/ ABS. 1 Type C Poort. 2 Poorten USB 2.0.

7.9 x 1.2 x 3.7 cm 200 / 50 Print Code: D(4), W



NATURAL STONE



New

New



Surgex 21042



Charging Cable. Natural Stone Extracts/ ABS. Micro USB, Type C and Lightning Connection 5V DC 2.4A.
Ladegerät kabel. Natursteinextrakte/ ABS. Anschluss Micro USB, Typ C und Lightning 5V DC 2.4A.
Câble de Charge. Extraits de Pierre Naturelle/ ABS. Connexion Micro USB, Type C et Lightning 5V DC 2.4A.
Opladkabel. Extracten van Natuursteen/ ABS. Micro USB, Type C en Lightning Connectie 5V DC 2.4A.

18 x 2.5 x 0.8 cm 500 / 50 Print Code: D(4)

Bekery 21038

Earphones. Natural Stone Extracts/ ABS. Bluetooth Connection. Battery 30 mAh/ Charging Station 250 mAh.
Kopfhörer. Natursteinextrakte/ ABS. Bluetooth Anschluss. Batterie 30 mAh/ Aufladestation 250 mAh.
Écouteurs. Extraits de Pierre Naturelle/ ABS. Connexion Bluetooth. Batterie 30 mAh/ Poste de Charge 250 mAh.
Oordopjes. Extracten van Natuursteen/ ABS. Bluetooth Verbinding. Batterij 30 mAh/ Opladstation 250 mAh.

Ø 5.8 x 2.5 cm 50 Print Code: E(4)

COFFEE FIBRE RECYCLED & COTTON

New

Mayer 20277

5000
mAh

New

Griffin 20278

(15W)
WIRELESS
CHARGER

Charger. Coffee Fibre/ ABS/ Recycled Cotton. Wireless 15W.
Ladegerät. Kaffeefaser/ ABS/ Recycling Baumwolle. Drahtlos 15W.
Chargeur. Fibre de café/ ABS/ Coton Recyclé. Sans Fil 15W.
Oplader. Koffievezel/ ABS/ Gerecycled Katoen. Draadloos 15W.

7.8 x 1 x 7.8 cm 100 / 50 Print Code: E(4), N(8)



Mayer 20277

Power Bank. Coffee Fibre/ ABS/ Recycled Cotton. 5000 mAh. 2 USB and 1 Type C Outputs. Micro USB and Type C Input.

Power Bank. Kaffeefaser/ ABS/ Recycling Baumwolle. 5000 mAh. 2 USB und 1 Typ C Ausgänge. Micro USB und Typ C Eingang.

Power Bank. Fibre de café/ ABS/ Coton Recyclé. 5000 mAh. 2 Sorties USB et 1 Type C. Entrée Micro USB et Type C.

Power Bank. Koffievezel/ ABS/ Gerecycled Katoen. 5000 mAh. 2 USB en 1 Typ C Outputs. Micro USB en Type C Input.

6.8 x 13 x 1.2 cm 50 / 25 Print Code: E(4), N(8)



New

New

New

Nyxlox 21198

IN/OUT
TYPE C

USB Hub. Coffee Fibre/ ABS/ Recycled Cotton. 1 Hub Type C. 2 Hubs USB 2.0.
USB Hub. Kaffeefaser/ ABS/ Recycling Baumwolle. 1 Typ C Hub. 2 Hubs USB 2.0.
Port USB. Fibre de café/ ABS/ Coton Recyclé. 1 Port Type C. 2 Ports USB 2.0.
USB Hub. Koffievezel/ ABS/ Gerecycled Katoen. 1 Type C Poort. 2 Poorten USB 2.0.

8.1 x 1 x 3.7 cm 200 / 50 Print Code: D(4), N(8)

Seymur 20280

IN/OUT
TYPE C

2 in 1
MICRO USB &
LIGHTNING

Charging Cable. Coffee Fibre/ ABS/ Recycled Cotton. Micro USB, Type C and Lightning Connection 5V DC 2.4A.
Ladegerätkabel. Kaffeefaser/ ABS/ Recycling Baumwolle. Anschluss Micro USB, Typ C and Lightning 5V DC 2.4A.
Câble de Charge. Fibre de café/ ABS/ Coton Recyclé. Connexion Micro USB, Type C et Lightning 5V DC 2.4A.
Oplaadkabel. Koffievezel/ ABS/ Gerecycled Katoen. Micro USB, Type C en Lightning Connectie 5V DC 2.4A.

120 x 4 x 1.3 cm 500 / 50 Print Code: E(1)

Barret 20279

TEMPERATURE

ALARM

TIME & DATE

Multifunction Alarm Clock. Coffee Fibre/ ABS/ Recycled Cotton. Wireless Charger 10W. Adjustable Brightness. USB Connection.
Multifunktions Tischuhr. Kaffeefaser/ ABS/ Recycling Baumwolle. Drahtlos Ladegerät 10W. Einstellbare Lichtintensität. USB Anschluss.
Horloge Multifonction. Fibre de café/ ABS/ Coton Recyclé. Chargeur Sans Fil 10W. Lumière à Intensité Réglable. Connexion USB.
Multifunctioneel Klok. Koffievezel/ ABS/ Gerecycled Katoen. Draadloos Oplader 10W. Lamp met Instelbare Lichtintensiteit. USB Verbinding.

15.6 x 3.6 x 7.6 cm 40 Print Code: E(4), W

& Bamboo

-RECYCLED- MILK CARTON



Kartip 21208



USB Hub. Recycled Milk Cartons/ Bamboo. 1 Hub Type C. 2 Hubs USB 2.0.
USB Hub. Recyclelte Milchkartons/ Bambus. 1 Typ C Hub. 2 Hubs USB 2.0.
Port USB. Cartons de Lait Recyclés/ Bambou. 1 Port Type C. 2 Ports USB 2.0.
USB Hub. Gerecycleerde Melkpakken/ Bamboe. 1 Type C Poort. 2 Poorten USB 2.0.

7,5 x 4,6 x 1,5 cm 100 / 50 Print Code: D(4)



Sucrep 21207 ^(15W)

WIRELESS CHARGER

Charger. Recycled Milk Cartons/ Bamboo. Wireless 15W. 1 USB Output and 1 Type C Output.

Ladegerät. Recyclelte Milchkartons/ Bambus. Drahtlos 15W. 1 Salida USB y 1 Salida Tipo C.

Chargeur. Cartons de Lait Recyclés/ Bambou. Sans Fil 15W. 1 Sortie USB et 1 Sortie Type C.

Oplader. Gerecycleerde Melkpakken/ Bamboe. Draadloos 15W. 1 USB Output en 1 Typ C Output.

9,2 x 1,3 x 9,2 cm 50 / 25 Print Code: E(4), W



Panther 21206

^(15W)

WIRELESS CHARGER

Charger. Recycled Milk Cartons/ Bamboo. Wireless 15W.

Ladegerät. Recyclelte Milchkartons/ Bambus. Drahtlos 15W.

Chargeur. Cartons de Lait Recyclés/ Bambou. Sans Fil 15W.

Oplader. Gerecycleerde Melkpakken/ Bamboe. Draadloos 15W.

8 x 1,1 x 8,6 cm 100 / 25 Print Code: E(4), W



Poskin 21209



Charging Cable. Recycled Milk Cartons/ Bamboo. Micro USB, Type C and Lightning Connection 5V DC 2.4A.

Ladegerät. Recyclelte Milchkartons/ Bambus. Anschluss Micro USB, Typ C und Lightning 5V DC 2.4A.

Câble de Charge. Cartons de Lait Recyclés/ Bambou. Connexion Micro USB, Type C et Lightning 5V DC 2.4A.

Opladkabel. Gerecycleerde Melkpakken/ Bamboe. Micro USB, Type C en Lightning Connectie 5V DC 2.4A.

3 x 18 x 2 cm 200 / 50 Print Code: D(4)



Zapa RCS 20854

PD
POWER
DELIVERY



Charging Cable. Recycled ABS. Suitable for data transfer. Extendable Cable. Micro USB, Type C Connection PD 65W.
Ladegerät-kabel. Recycling ABS. Geeignet für die Datenübertragung. Ausziehbares Kabel. Anschluss Typ C PD 65W.
Câble de Charge. ABS Recyclé. Convient au transfert de données. Câble Extensible. Connexion Type C PD 65W.
Oplaadkabel. Gerecycled ABS. Geschikt voor data-overdracht. Verlengbare Kabel. Type C Connectie PD 65W.

80 x 5.5 x 2.5 cm 200 / 50 Print Code: E(4), W

Recycled ABS



Nofler RCS 20853



USB Hub. Recycled ABS. 1 Hub Type C. 2 Hubs USB 2.0.
USB Hub. Recycling ABS. 1 Typ C Hub. 2 Hubs USB 2.0.
Port USB. ABS Recyclé. 1 Port Type C. 2 Ports USB 2.0.
USB Hub. Gerecycled ABS. 1 Type C Poort. 2 Poorten USB 2.0.

8.4 x 2.3 x 4.1 cm 200 / 50 Print Code: D(4), W



Volpux RCS 1149

Earphones. Recycled ABS. Bluetooth Connection. Battery 35 mAh/
Charging Station 200 mAh.
Kopfhörer. Recycling ABS. Bluetooth Anschluss. Batterie 35 mAh/
Aufladestation 200 mAh.
Écouteurs. ABS Recyclé. Connexion Bluetooth. Batterie 35 mAh/
Poste de Charge 200 mAh.
Oordopjes. Gerecycled ABS. Bluetooth Verbinding. Batterij 35
mAh/ Oplaadstation 200 mAh.

5.5 x 2.6 x 4.8 cm 100 / 50 Print Code: E(4), W



Medran RCS 1151

Speaker. Recycled ABS. Bluetooth Connection. Sound Power 3W. Battery 400 mAh.
Lautsprecher. Recycling ABS. Bluetooth Anschluss. Schallleistung 3W. Batterie 400 mAh.
Haut-Parleur. ABS Recyclé. Connexion Bluetooth. Puissance Sonore 3W. Batterie 400 mAh.
Luidspreker. Gerecycled ABS. Bluetooth Verbinding. Geluidsvermogen 3W. Batterij 400 mAh.

Ø 6.2 x 6.4 cm 50 / 25 Print Code: E(4)



Chestir RCS 1423

Mouse. Recycled ABS. Wireless. Optical. DPI Button. Battery 500 mAh.
Maus. Recycling ABS. Drahtlos. Optisch. DPI Taste. Batterie 500 mAh.
Souris. ABS Recyclé. Sans Fil. Optique. Bouton DPI. Batterie 500 mAh.
Muis. Gerecycled ABS. Draadloos. Optisch. DPI Knop. Batterij 500 mAh.

11.2 x 2.5 x 5.5 cm 100 / 50 Print Code: E(4), W



Nawey RCS 20850

Power Bank. Recycled ABS. 5000 mAh. 2 USB Outputs. Micro USB Input. Type C Output and Input.
 Power Bank. Recycling ABS. 5000 mAh. 2 USB Ausgänge. Micro USB Eingang. Typ C Ausgänge und Eingang.
 Power Bank. ABS Recyclé. 5000 mAh. 2 Sortie USB. Entrée Micro USB. Sortie et Entrée Type C.
 Power Bank. Gerecycled ABS. 5000 mAh. 2 USB Outputs. Micro USB Input. Typ C Output en Input.

6.3 x 9.1 x 1.5 cm 50 / 25 Print Code: E(4), W

Recycled ABS



Tayil RCS 20852 ((15W))

Charger. Recycled ABS. Wireless 15W.
 Ladegerät. Recycling ABS. Drahtlos 15W.
 Chargeur. ABS Recyclé. Sans Fil 15W.
 Oplader. Gerecycled ABS. Draadloos 15W.

7 x 10.9 x 8.5 cm 50 / 25 Print Code: E(4)



COMPATIBLE WITH
MAGSAFE & Qi
TECHNOLOGY

Dixlem RCS 1152

Charger. Recycled ABS. Wireless 10W. Magnetic.
 Ladegerät. Recycling ABS. Drahtlos 10W. Magnetisch.
 Chargeur. ABS Recyclé. Sans Fil 10W. Magnétique.
 Oplader. Gerecycled ABS. Draadloos 10W. Magnetisch.

6.3 x 0.9 cm 200 / 100
 Print Code: E(4), W



ADHESIVE ACCESSORY
INCLUDED



Zosmal RCS 1150

Charger. Recycled ABS. Wireless 10W.
 Ladegerät. Recycling ABS. Drahtlos 10W.
 Chargeur. ABS Recyclé. Sans Fil 10W.
 Oplader. Gerecycled ABS. Draadloos 10W.

10.6 x 1 x 7.3 cm 100 / 50 Print Code: E(4), W

Kambel RCS 20851 ((15W))

Charger. Recycled ABS. Wireless 15W.
 Ladegerät. Recycling ABS. Drahtlos 15W.
 Chargeur. ABS Recyclé. Sans Fil 15W.
 Oplader. Gerecycled ABS. Draadloos 15W.

10 x 0.6 cm 100 / 25 Print Code: E(4), W

Pla&bamboo



Ditte 1196

PD
POWER
DELIVERY

((15W))
WIRELESS
CHARGER

Power Bank. Bamboe/ PLA Compostable. Draadloos 15W, 8000 mAh. 1 USB and 1 Type C Output. Micro USB and Type C Input.
Power Bank. Bambus/ PLA Kompostierbar. Drahtlos 15W, 8000 mAh. 1 USB und 1 Typ C Ausgänge. Micro USB und Typ C Eingang.
Power Bank. Bamboe/ PLA Compostable. Sans Fil 15W, 8000 mAh. 1 Sortie USB et 1 Type C. Entrée Micro USB et Type C.
Power Bank. Bamboe/ PLA Composteerbaar. Draadloos 15W, 8000 mAh. 1 USB en 1 Typ C Output. Micro USB en Type C Input.

7 x 13.5 x 1.8 cm 40 / 10 Print Code: E(4), L2, W



COMPATIBLE WITH
MAGSAFE & Qi
TECHNOLOGY

Noopy 1197

Holder Charger. Bamboe/ PLA Compostable. Draadloos 10W, Magnetsch.
Halter Ladegerät. Bambus/ PLA Kompostierbar. Drahtlos 10W, Magnetsch.
Chargeur Support. Bamboe/ PLA Compostable. Sans Fil 10W, Magnétique.
Houder Oplader. Bamboe/ PLA Composteerbaar. Draadloos 10W, Magnetsch.

7.7 x 12 x 7.8 cm 80 / 40 Print Code: E(4), L2



ADHESIVE ACCESSORY
INCLUDED



Pixie 1195

HANDS-FREE

Speaker. Bamboe/ PLA Compostable. Bluetooth Connection. Sound Power 3W. Batterie 300 mAh.
Lautsprecher. Bambus/ PLA Kompostierbar. Bluetooth Anschluss. Schallleistung 3W. Batterie 300 mAh.
Haut-Parleur. Bamboe/ PLA Compostable. Connexion Bluetooth. Puissance Sonore 3W. Batterie 300 mAh.
Luidspreker. Bamboe/ PLA Composteerbaar. Bluetooth Verbinding. Geluidsvermogen 3W. Batterij 300 mAh.

6.5 x 6.5 x 5.2 cm 50 / 25 Print Code: E(4), L1, W



Kermi 1421

Earphones. Bamboe/ PLA Compostable. Bluetooth Connection. Batterie 30 mAh/ Charging Station 250 mAh.
Kopfhörer. Bambus/ PLA Kompostierbar. Bluetooth Anschluss. Batterie 30 mAh/ Aufladestation 250 mAh.
Écouteurs. Bamboe/ PLA Compostable. Connexion Bluetooth. Batterie 30 mAh/ Poste de Charge 250 mAh.
Oordopjes. Bamboe/ PLA Composteerbaar. Bluetooth Verbinding. Batterij 30 mAh/ Opladstation 250 mAh.

6.5 x 3.6 x 2.5 cm 200 / 50 Print Code: E(4), L1, W

Bamboo & Wheat & Straw



New

5000
mAh

Coquin 21219

Power Bank. Wheat Straw/ ABS/ Bamboo. 5000 mAh. USB Output. Type C Output and Input.
 Power Bank. Weizenstroh/ ABS/ Bambus. 5000 mAh. USB Ausgang. Typ C Ausgänge und Eingang.
 Power Bank. Paille de Blé/ ABS/ Bambou. 5000 mAh. Sortie USB. Sortie et Entrée Type C.
 Power Bank. Tarwestro/ ABS/ Bamboe. 5000 mAh. USB Output. Typ C Output en Input.

6.8 x 13.7 x 1 cm 100 / 50 Print Code: E(4), W



New

4500
mAh

Reneh 21222

Power Bank. Wheat Straw/ ABS/ Bamboo. 4500 mAh. USB Output. Type C Output and Input.
 Power Bank. Weizenstroh/ ABS/ Bambus. 4500 mAh. USB Ausgang. Typ C Ausgänge und Eingang.
 Power Bank. Paille de Blé/ ABS/ Bambou. 4500 mAh. Sortie USB. Sortie et Entrée Type C.
 Power Bank. Tarwestro/ ABS/ Bamboe. 4500 mAh. USB Output. Typ C Output en Input.

Ø 3.2 x 11 cm 50 / 25 Print Code: E(4), L1



New

(15W)
WIRELESS
CHARGER

Bisop 21218

Charger Holder. Wheat Straw/ ABS/ Bamboo. Wireless 15W.
 Foldable. Adjustable Height and Angle.
 Ladegerät Halter. Weizenstroh/ ABS/ Bambus. Drahtlos 15W.
 Faltpbar. Höhe und Winkel Verstellbar.
 Support Chargeur. Paille de Blé/ ABS/ Bambou. Sans Fil 15W.
 Pliable. Hauteur et Angle Réglable.

Oplader Houder. Tarwestro/ ABS/ Bamboe. Draadloos 15W.
 Opvouwbaar. Aanpasbaar Hoogte en Hoek.
 6.6 x 12.3 x 11 cm 50 / 25 Print Code: E(1), L2



New

PD
POWER
DELIVERY

Sugax 21221

USB Charger. Wheat Straw/ ABS/ Bamboo. Fast Charger. 1 USB Output and 1 Type C Output.
 USB Ladegerät. Weizenstroh/ ABS/ Bambus. Schnelle Aufladung. 1 USB Ausgang und 1 Typ C Ausgang.
 Chargeur USB. Paille de Blé/ ABS/ Bambou. Charge Rapide. 1 Sortie USB et 1 Sortie Type C.
 USB Oplader. Tarwestro/ ABS/ Bamboe. Snellader. 1 USB Output en 1 Typ C Output.

4.6 x 8 x 3.2 cm 100 / 50 Print Code: E(4), L1, W



New

Krofin 21220

Earphones. Wheat Straw/ ABS/ Bamboo. Bluetooth Connection. Battery 30 mAh/ Charging Station 250 mAh.
 Kopfhörer. Weizenstroh/ ABS/ Bambus. Bluetooth Anschluss. Batterie 30 mAh/ Aufladestation 250 mAh.
 Écouteurs. Paille de Blé/ ABS/ Bambou. Connexion Bluetooth. Batterie 30 mAh/ Poste de Charge 250 mAh.
 Oordopjes. Tarwestro/ ABS/ Bamboe. Bluetooth Verbinding. Batterij 30 mAh/ Opladstation 250 mAh.

Ø 5.7 x 2.2 cm 100 / 50 Print Code: E(4)

& Bamboo Marble Extract



Brestin 1979



Charging Cable. Bamboo/ Marble Extract. Micro USB, Type C and Lightning Connection 5V DC 2.4A.
Ladegerät-kabel. Bambus/ Marmor Extrakten. Anschluss Micro USB, Typ C und Lightning 5V DC 2.4A.
Câble de Charge. Bambou/ Extrait Marbre. Connexion Micro USB, Type C et Lightning 5V DC 2.4A.
Oplaadkabel. Bamboe/ Marmer-Extraceten. Micro USB, Type C en Lightning Connectie 5V DC 2.4A.

3 x 22 x 1 cm 300 / 50 Print Code: D(4), L1



Pargon 1980

(15W)
WIRELESS CHARGER

Charger Holder. Bamboo/ Marble Extract. Wireless 15W.
Ladegerät Halter. Bambus/ Marmor Extrakten. Drahtlos 15W.
Support Chargeur. Bambou/ Extrait Marbre. Sans Fil 15W.
Oplader Houder. Bamboe/ Marmer-Extraceten. Draadloos 15W.

Ø 8.6 x 1.7 cm 50 / 25 Print Code: E(4), L2, W



Layais 1978



USB Hub. Bamboo/ Marble Extract. 1 Hub Type C. 2 Hubs USB 2.0.
USB Hub. Bambus/ Marmor Extrakten. 1 Typ C Hub. 2 Hubs USB 2.0.
Port USB. Bambou/ Extrait Marbre. 1 Port Type C. 2 Ports USB 2.0.
USB Hub. Bamboe/ Marmer-Extraceten. 1 Type C Poort. 2 Poorten USB 2.0.

7.7 x 1.2 x 4.7 cm 200 / 50 Print Code: D(4), L1, W



& Bamboo. recycled aluminium

New



(15W)
WIRELESS
CHARGER

Sutmy 21200

Charger. Recycled Aluminium/ Bamboo. Wireless 15W.
Ladegerät. Recycling Aluminium/ Bambus. Drahtlos 15W.
Chargeur. Aluminium Recyclé/ Bamboe. Sans Fil 15W.
Oplader. Gerecycled Aluminium/ Bamboe. Draadloos 15W.

📏 9.1 x 1.4 cm 📦 100 / 50 🗑️ Print Code: E(4), L2, W

New



5000
mAh

Newin 21203

Power Bank. Recycled Aluminium/ Bamboo. 5000 mAh. 2 USB Outputs. Type C Output and Input.
Power Bank. Recycling Aluminium/ Bambus. 5000 mAh. 2 USB Ausgänge. Typ C Ausgänge und Eingang.
Power Bank. Aluminium Recyclé/ Bamboe. 5000 mAh. 2 Sorties USB. Sortie et Entrée Type C.
Power Bank. Tarwestro/ ABS. 5000 mAh. 2 USB Outputs. Typ C Output en Input.

📏 6.4 x 10 x 1.6 cm 📦 50 / 25 🗑️ Print Code: E(4), L2, W

New



Zurk 21201



USB Hub. Recycled Aluminium/ Bamboo. 1 Hub Type C. 2 Hubs USB 2.0.
USB Hub. Recycling Aluminium/ Bambus. 1 Typ C Hub. 2 Hubs USB 2.0.
Port USB. Aluminium Recyclé/ Bamboe. 1 Port Type C. 2 Ports USB 2.0.
USB Hub. Gerecycled Aluminium/ Bamboe. 1 Type C Poort. 2 Poorten USB 2.0.

📏 8.1 x 1.2 x 4 cm 📦 100 / 50 🗑️ Print Code: D(4), L1

New



Desak 21202



Charging Cable. Recycled Aluminium/ Bamboo. Micro USB, Type C and Lightning Connection 5V DC 2.4A.
Ladegerätkabel. Recycling Aluminium/ Bambus. Anschluss Micro USB, Typ C und Lightning 5V DC 2.4A.
Câble de Charge. Aluminium Recyclé/ Bamboe. Connexion Micro USB, Type C et Lightning 5V DC 2.4A.
Oplaaadkabel. Tarwestro/ ABS. Micro USB, Type C en Lightning Connectie 5V DC 2.4A.

📏 3 x 18 x 1.5 cm 📦 200 / 50 🗑️ Print Code: D(4), L1

CHARGER

**Lac 21197**

Power Bank Earphones. Bamboo/ ABS. 4500 mAh. USB Output. Type C Output and Input. Bluetooth Connection. Batterie 30 mAh.
 Power Bank Kopfhörer. Bambus/ ABS. 4500 mAh. USB Ausgang. Typ C Ausgänge und Eingang. Bluetooth Anschluss. Batterie 30 mAh.
 Écouteurs Power Bank. Bambou/ ABS. 4500 mAh. Sortie USB. Sortie et Entrée Type C. Connexion Bluetooth. Batterie 30 mAh.
 Power Bank Oordopjes. Bamboe/ ABS. 4500 mAh. USB Output. Typ C Output en Input. Micro USB Input. Bluetooth Verbinding. Batterij 30 mAh.

📏 4 x 10 cm 📦 100 / 50
 🖨️ Print Code: E(4), L1

**Billins 1492**

Charger Earphones. Bamboo/ ABS. Wireless 10W. Bluetooth Connection. Battery 30 mAh/ Charging Station 300 mAh.
 Ladegerät Kopfhörer. Bambus/ ABS. Drahtlos 10W. Bluetooth Anschluss. Batterie 30 mAh/ Aufladestation 300 mAh.
 Écouteurs Chargeur. Bambou/ ABS. Sans Fil 10W. Connexion Bluetooth. Batterie 30 mAh/ Poste de Charge 300 mAh.
 Oplader Oordopjes. Bamboe/ ABS. Draadloos 10W. Bluetooth Verbinding. Batterij 30 mAh/ Opladstation 300 mAh.

📏 5.3 x 4.4 x 3 cm 📦 100 / 50 🖨️ Print Code: E(4), L1, W

SPEAKERS

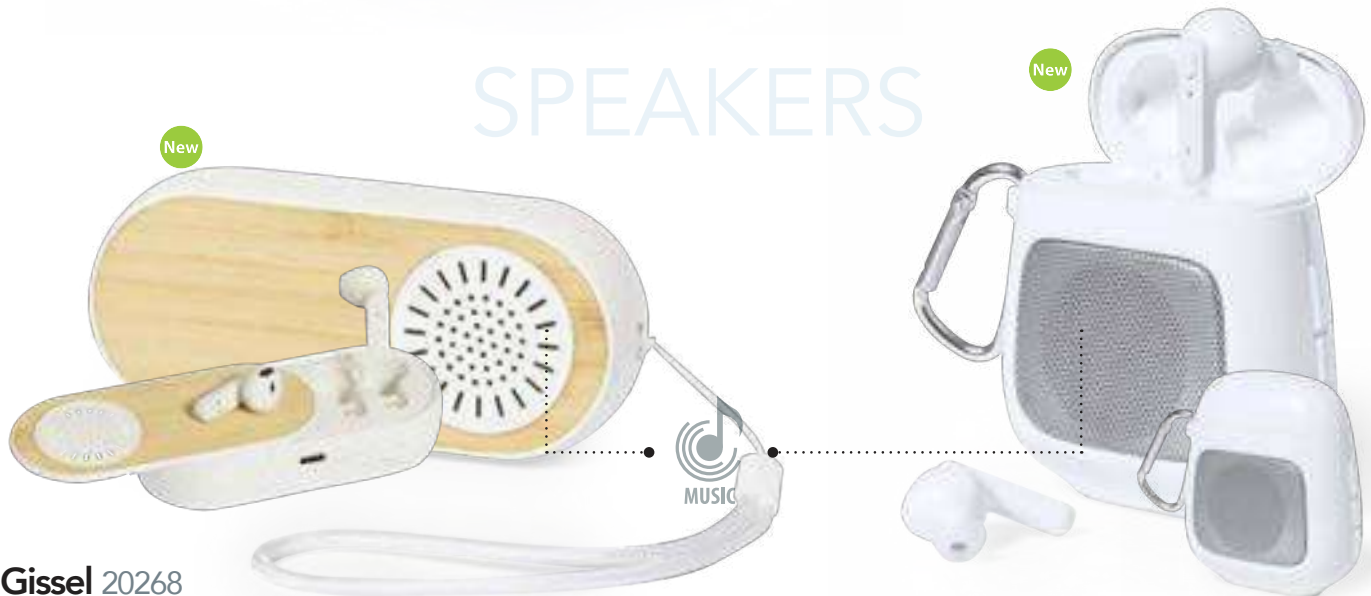
**Gissel 20268**

Speakers Earphones. Wheat Straw/ ABS/ Bamboo. Bluetooth Connection. Sound Power 3W. Battery 30 mAh/ Charging Station 300 mAh.
 Lautsprecher Kopfhörer. Weizenstroh/ ABS/ Bambus. Bluetooth Anschluss. Schallleistung 3W. Batterie 30 mAh/ Aufladestation 300 mAh.
 Écouteurs Haut-Parleurs. Paille de Blé/ ABS/ Bambou. Connexion Bluetooth. Puissance Sonore 3W. Batterie 30 mAh/ Poste de Charge 300 mAh.
 Luidsprekers Koptelefoon. Tarwestro/ ABS/ Bamboe. Bluetooth Verbinding. Geluidsvermogen 3W. Batterij 30 mAh/ Opladstation 300 mAh.

📏 10.5 x 2.5 x 5 cm 📦 100 / 50 🖨️ Print Code: E(4), L1, W

Boxy 20866

Speakers Earphones. Bluetooth Connection. Sound Power 3W. Battery 30 mAh/ Charging Station 600 mAh.
 Lautsprecher Kopfhörer. Bluetooth Anschluss. Schallleistung 3W. Batterie 30 mAh/ Aufladestation 600 mAh.
 Écouteurs Haut-Parleurs. Connexion Bluetooth. Puissance Sonore 3W. Batterie 30 mAh/ Poste de Charge 600 mAh.
 Luidsprekers Koptelefoon. Bluetooth Verbinding. Geluidsvermogen 3W. Batterij 30 mAh/ Opladstation 600 mAh.

📏 7.5 x 8.7 x 4 cm 📦 100 / 50 🖨️ Print Code: E(1)



Vounel 6628

Earphones. Wheat Straw/ ABS. Bluetooth Connection. Battery 35 mAh/ Charging Station 400 mAh.
 Kopfhörer. Weizenstroh/ ABS. Bluetooth Anschluss. Batterie 35 mAh/ Aufladestation 400 mAh.
 Écouteurs. Paille de Blé/ ABS. Connexion Bluetooth. Batterie 35 mAh/ Poste de Charge 400 mAh.
 Oordopjes. Tarwestro/ ABS. Bluetooth Verbinding. Batterij 35 mAh/ Oplaadstation 400 mAh.

4.5 x 6.8 x 2.2 cm 100 / 50 Print Code: E(4), W



Oriley 21031

Earphones. Wheat Straw/ ABS. Bluetooth Connection. Battery 30 mAh/ Charging Station 200 mAh.
 Kopfhörer. Weizenstroh/ ABS. Bluetooth Anschluss. Batterie 30 mAh/ Aufladestation 200 mAh.
 Écouteurs. Paille de Blé/ ABS. Connexion Bluetooth. Batterie 30 mAh/ Poste de Charge 200 mAh.
 Oordopjes. Tarwestro/ ABS. Bluetooth Verbinding. Batterij 30 mAh/ Oplaadstation 200 mAh.

4.6 x 2.9 x 4.6 cm 100 / 50 Print Code: E(4), W



Shizar RCS 1983

Earphones. Recycled Leather/ Recycled ABS. Bluetooth Connection. Battery 30 mAh/ Charging Station 300 mAh.
 Kopfhörer. Recycling Leder/ Recycling ABS. Bluetooth Anschluss. Batterie 30 mAh/ Aufladestation 300 mAh.
 Écouteurs. Cuir Recyclé/ ABS Recyclé. Connexion Bluetooth. Batterie 30 mAh/ Poste de Charge 300 mAh.
 Oordopjes. Gerecycled Leer/ Gerecycled ABS. Bluetooth Verbinding. Batterij 30 mAh/ Oplaadstation 300 mAh.

6.2 x 2.2 x 3.9 cm 100 / 50
 Print Code: E(4), L1



Grigal 1967

Earphones. Cork/ Bamboo. Bluetooth Connection. Battery 30 mAh/ Charging Station 300 mAh.
 Kopfhörer. Kork/ Bambus. Bluetooth Anschluss. Batterie 30 mAh/ Aufladestation 300 mAh.
 Écouteurs. Liège/ Bambou. Connexion Bluetooth. Batterie 30 mAh/ Poste de Charge 300 mAh.
 Oordopjes. Kurk/ Bamboe. Bluetooth Verbinding. Batterij 30 mAh/ Oplaadstation 300 mAh.

Ø 6.1 x 3.8 cm 100 / 50 Print Code: E(4), L1, W



Tresan 6808

Earphones. Bamboo/ ABS. Bluetooth Connection. Battery 35 mAh/ Charging Station 400 mAh.
 Kopfhörer. Bambus/ ABS. Bluetooth Anschluss. Batterie 35 mAh/ Aufladestation 400 mAh.
 Écouteurs. Bamboe/ ABS. Connexion Bluetooth. Batterie 35 mAh/ Poste de Charge 400 mAh.
 Oordopjes. Bamboe/ ABS. Bluetooth Verbinding. Batterij 35 mAh/ Oplaadstation 400 mAh.

4.7 x 9 x 3.3 cm 100 / 50 Print Code: E(4), L1, W



BLUETOOTH
EARPHONES**Gemston 20872**

Earphones Clip. Bluetooth Connection. Battery 30 mAh/ Charging Station 200 mAh.
 Clip Kopfhörer. Bluetooth Anschluss. Batterie 30 mAh/ Aufladestation 200 mAh.
 Écouteurs Clip. Connexion Bluetooth. Batterie 30 mAh/ Poste de Charge 200 mAh.
 Clip Oordopjes. Bluetooth Verbinding. Batterij 30 mAh/ Oplaadstation 200 mAh.

2.4 x 6.9 x 2.4 cm 50 / 25 Print Code: E(4), W

Dodiax 20295

Earphones. Bluetooth Connection. Battery 30 mAh/ Charging Station 300 mAh.
 Kopfhörer. Bluetooth Anschluss. Batterie 30 mAh/ Aufladestation 300 mAh.
 Écouteurs. Connexion Bluetooth. Batterie 30 mAh/ Poste de Charge 300 mAh.
 Oordopjes. Bluetooth Verbinding. Batterij 30 mAh/ Oplaadstation 300 mAh.

5.4 x 4.6 x 2.1 cm 100 / 50 Print Code: E(4), W

Prucky 1994

Earphones. Bluetooth Connection. Battery 35 mAh/ Charging Station 300 mAh.
 Kopfhörer. Bluetooth Anschluss. Batterie 35 mAh/ Aufladestation 300 mAh.
 Écouteurs. Connexion Bluetooth. Batterie 35 mAh/ Poste de Charge 300 mAh.
 Oordopjes. Bluetooth Verbinding. Batterij 35 mAh/ Oplaadstation 300 mAh.

4.5 x 6.2 x 2.5 cm 100 / 50 Print Code: E(4), W



Protex 6511

Earphones. Bluetooth Connection. Battery 35 mAh/ Charging Station 400 mAh.
 Kopfhörer: Bluetooth Anschluss. Batterie 35 mAh/ Aufladestation 400 mAh.
 Écouteurs. Connexion Bluetooth. Batterie 35 mAh/ Poste de Charge 400 mAh.
 Oordopjes. Bluetooth Verbinding. Batterij 35 mAh/ Oplaadstation 400 mAh.

4.5 × 6.8 × 2.2 cm 100 / 50 Print Code: E(4), W



Stigo 20873

Earphones. Bluetooth Connection. Battery 30 mAh/ Charging Station 250 mAh.
 Kopfhörer: Bluetooth Anschluss. Batterie 30 mAh/ Aufladestation 250 mAh.
 Écouteurs. Connexion Bluetooth. Batterie 30 mAh/ Poste de Charge 250 mAh.
 Oordopjes. Bluetooth Verbinding. Batterij 30 mAh/ Oplaadstation 250 mAh.

4.8 × 2.4 × 4.5 cm 100 / 50 Print Code: E(4), W

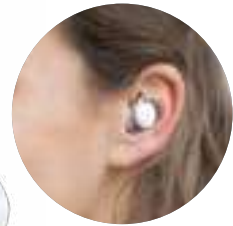

Kikey 6688

Antibacterial Earphones. Bluetooth Connection. Battery 35 mAh/ Charging Station 400 mAh.
 Antibakteriell Kopfhörer: Bluetooth Anschluss. Batterie 35 mAh/ Aufladestation 400 mAh.
 Écouteurs Antibacterienne. Connexion Bluetooth. Batterie 35 mAh/ Poste de Charge 400 mAh.
 Antibacterieel Oordopjes. Bluetooth Verbinding. Batterij 35 mAh/ Oplaadstation 400 mAh.

4.5 × 6.8 × 2.2 cm 100 / 50 Print Code: E(4), W



Shima 20294

Earphones. Bluetooth Connection. Battery 30 mAh/ Charging Station 200 mAh.
 Kopfhörer: Bluetooth Anschluss. Batterie 30 mAh/ Aufladestation 200 mAh.
 Écouteurs. Connexion Bluetooth. Batterie 30 mAh/ Poste de Charge 200 mAh.
 Oordopjes. Bluetooth Verbinding. Batterij 30 mAh/ Oplaadstation 200 mAh.

Ø 5 × 2.1 cm 100 / 50 Print Code: E(4), W



Pulsex 20874

Earphones. Bluetooth Connection. Battery 70 mAh.
Kopfhörer. Bluetooth Anschluss. Batterie 70 mAh.
Écouteurs. Connexion Bluetooth. Batterie 70 mAh.
Oordopjes. Bluetooth Verbinding. Batterij 70 mAh.

10 x 12 x 2.2 cm 100 / 25 Print Code: E(1)



Blair 20273

Earphones. Bluetooth Connection. Battery 30 mAh/ Charging Station 230 mAh.
Kopfhörer. Bluetooth Anschluss. Batterie 30 mAh/ Aufladestation 230 mAh.
Écouteurs. Connexion Bluetooth. Batterie 30 mAh/ Poste de Charge 230 mAh.
Oordopjes. Bluetooth Verbinding. Batterij 30 mAh/ Oplaadstation 230 mAh.

5.9 x 4.6 x 2.6 cm 100 / 50 Print Code: E(4), W



Merkus 6257

Earphones. Bluetooth Connection. Battery 50 mAh/ Charging Station 250 mAh.
Kopfhörer. Bluetooth Anschluss. Batterie 50 mAh/ Aufladestation 250 mAh.
Écouteurs. Connexion Bluetooth. Batterie 50 mAh/ Poste de Charge 250 mAh.
Oordopjes. Bluetooth Verbinding. Batterij 50 mAh/ Oplaadstation 250 mAh.

7.2 x 3 x 3.8 cm 100 / 50 Print Code: E(4), W



Baksen 1461

Earphones. Bluetooth Connection. Battery 35 mAh/ Charging Station 300 mAh.
Kopfhörer. Bluetooth Anschluss. Batterie 35 mAh/ Aufladestation 300 mAh.
Écouteurs. Connexion Bluetooth. Batterie 35 mAh/ Poste de Charge 300 mAh.
Oordopjes. Bluetooth Verbinding. Batterij 35 mAh/ Oplaadstation 300 mAh.

5.9 x 5.4 x 2.5 cm 100 / 50 Print Code: E(4), W



IDEAL FOR SHARING



LIMITED
edition
EXPERIENCE



Zoe 1363

Earphones. Bamboo/ ABS. Bluetooth Connection. Battery 35 mAh/ Charging Station 300 mAh.
Kopfhörer. Bambus/ ABS. Bluetooth Anschluss. Batterie 35 mAh/ Aufladestation 300 mAh.
Écouteurs. Bambou/ ABS. Connexion Bluetooth. Batterie 35 mAh/ Poste de Charge 300 mAh.
Oordopjes. Bamboe/ ABS. Bluetooth Verbinding. Batterij 35 mAh/ Oplaadstation 300 mAh.

4.1 x 3.5 x 3.3 cm 100 / 50 Print Code: E(4), F(1), L2, W

LIMITED
edition
EXPERIENCE



Crawly 1747

Earphones. Cork/ ABS. Bluetooth Connection. Battery 30 mAh/ Charging Station 300 mAh.
Kopfhörer. Kork/ ABS. Bluetooth Anschluss. Batterie 30 mAh/ Aufladestation 300 mAh.
Écouteurs. Liège/ ABS. Connexion Bluetooth. Batterie 30 mAh/ Poste de Charge 300 mAh.
Oordopjes. Kurk/ ABS. Bluetooth Verbinding. Batterij 30 mAh/ Oplaadstation 300 mAh.

5.7 x 4.5 x 2.4 cm 100 / 50 Print Code: E(4), F(1), L2



ANTONIO MIRO

Antonio Miró is currently a benchmark in the increasingly demanding fashion industry. Worldwide renowned and consolidated in showcases such as Paris, Milan, New York and Tokyo, with prestige earned by collections based on simplicity and perfection, being these his personal hallmarks. Minimalist like few others, Antonio Miró devotes his success to elegance, an objective he has never renounced.



Trustal 7380

Earphones. Bluetooth Connection. Battery 30 mAh/ Charging Station 300 mAh.
Kopfhörer. Bluetooth Anschluss. Batterie 30 mAh/ Aufladestation 300 mAh.
Écouteurs. Connexion Bluetooth. Batterie 30 mAh/ Poste de Charge 300 mAh.
Oordopjes. Bluetooth Verbinding. Batterij 30 mAh/ Oplaadstation 300 mAh.

5.5 x 2.3 x 5.5 cm 100 / 50 Print Code: E(4), W



Vinzer 6926

Earphones. Bluetooth Connection. Solar Charging. Battery 40 mAh/ Charging Station 260 mAh.
Kopfhörer. Bluetooth Anschluss. Solartladung. Batterie 40 mAh/ Aufladestation 260 mAh.
Écouteurs. Connexion Bluetooth. Charge Solaire. Batterie 40 mAh/ Poste de Charge 260 mAh.
Oordopjes. Bluetooth Verbinding. Zonnelading. Batterij 40 mAh/ Oplaadstation 260 mAh.

5.1 × 5.3 × 2.6 cm 100 / 50 Print Code: E(4)



Helton 1960

Headphones. Bluetooth Connection. Battery 250 mAh.
Kopfhörer. Bluetooth Anschluss. Batterie 250 mAh.
Écouteurs. Connexion Bluetooth. Batterie 250 mAh.
Oordopjes. Bluetooth Verbinding. Batterij 250 mAh.

13 × 4.3 × 10.2 cm 50 Print Code: F(1)

multifunction
earphones



Molik 6302

Power Bank Earphones. Wireless 5W. 5200 mAh. USB Output. Type C Input. Bluetooth Connection. Battery 35 mAh.
Power Bank Kopfhörer. Drahtlos 5W. 5200 mAh. USB Ausgang. Typ C Eingang. Bluetooth Anschluss. Batterie 35 mAh.
Écouteurs Power Bank. Sans Fil 5W. 5200 mAh. Sortie USB. Entrée Type C. Connexion Bluetooth. Batterie 35 mAh.
Power Bank Oordopjes. Draadloos 5W. 5200 mAh. USB Output. Typ C Input. Micro USB Input. Bluetooth Verbinding. Batterij 35 mAh.

8.4 × 9.8 × 2.6 cm 50 / 25 Print Code: E(4), W



Benyer 6891

Charger Earphones. Bluetooth Connection. Wireless 5W. Battery 40 mAh/ Charging Station 300 mAh.
Ladegerät Kopfhörer. Bluetooth Anschluss. Drahtlos 5W. Batterie 40 mAh/ Aufladestation 300 mAh.
Écouteurs Chargeur. Connexion Bluetooth. Sans Fil 5W. Batterie 40 mAh/ Poste de Charge 300 mAh.
Oplader Oordopjes. Bluetooth Verbinding. Draadloos 5W. Batterij 40 mAh/ Oplaadstation 300 mAh.

7.6 × 7.6 × 3.8 cm 50 / 25
Print Code: E(4), W





Steppek 5395

Earphones. Bluetooth Connection. Battery 55 mAh.
Kopfhörer. Bluetooth Anschluss. Batterie 55 mAh.
Écouteurs. Connexion Bluetooth. Batterie 55 mAh.
Oordopjes. Bluetooth Verbinding. Batterij 55 mAh.

5 × 7 × 3 cm 200 / 50 Print Code: E(1), F(4)



Sopral 5953

Earphones. Bluetooth Connection. Battery 50 mAh.
Kopfhörer. Bluetooth Anschluss. Batterie 50 mAh.
Écouteurs. Connexion Bluetooth. Batterie 50 mAh.
Oordopjes. Bluetooth Verbinding. Batterij 50 mAh.

Ø 8 × 3.9 cm 200 / 50 Print Code: E(1), F(4)



Trubus 1957

Earphones. Type C Connection.
Kopfhörer. Anschluss Typ C.
Écouteurs. Connexion Type C.
Oordopjes. Type C Connectie.

7 × 7 × 2 cm 300 / 100 Print Code: D(1), W

Type C



Cort 3551

Earphones. 3.5 mm Jack Socket.
Kopfhörer. 3,5 mm Klinkenstecker.
Écouteurs. Connexion Jack 3,5 mm.
Oordopjes. 3,5 mm Jack Aansluiting.

7 × 7 × 2 cm 500 / 50 Print Code: D(1), W



Bluetooth headphones



01



02



03

Pendil 1959



MICRO SD

FM
RADIO

Headphones. Bluetooth Connection. 3,5 mm Jack Socket. Battery 200 mAh.

Kopfhörer. Bluetooth Anschluss. 3,5 mm Klinkestecker. Batterie 200 mAh.

Écouteurs. Connexion Bluetooth. Connexion Jack 3,5 mm. Batterie 200 mAh.

Koptelefoon. Bluetooth Verbinding. 3,5 mm Jack Aansluiting. Batterij 200 mAh.

16.3 x 19 x 7 cm 20 Print Code: F(1)



19



01



02

Magnel 6266

Headphones. Bluetooth Connection. 3,5 mm Jack Socket. Battery 150 mAh.

Kopfhörer. Bluetooth Anschluss. 3,5 mm Klinkestecker. Batterie 150 mAh.

Écouteurs. Connexion Bluetooth. Connexion Jack 3,5 mm. Batterie 150 mAh.

Koptelefoon. Bluetooth Verbinding. 3,5 mm Jack Aansluiting. Batterij 150 mAh.

17.5 x 18.5 x 7.7 cm 20 Print Code: F(1)



02

Legolax 5531



MICRO SD

FM
RADIO

Headphones. Bluetooth Connection. 3,5 mm Jack Socket. Battery 400 mAh.

Kopfhörer. Bluetooth Anschluss. 3,5 mm Klinkestecker. Batterie 400 mAh.

Écouteurs. Connexion Bluetooth. Connexion Jack 3,5 mm. Batterie 400 mAh.

Koptelefoon. Bluetooth Verbinding. 3,5 mm Jack Aansluiting. Batterij 400 mAh.

18 x 18.5 x 7.8 cm 20 / 10 Print Code: F(1)



19

03

01



Witums 1430



Headphones. Bluetooth Connection. 3,5 mm Jack Socket. Battery 300 mAh.
Kopfhörer: Bluetooth Anschluss. 3,5 mm Klinkestecker. Batterie 300 mAh.
Écouteurs. Connexion Bluetooth. Connexion Jack 3,5 mm. Batterie 300 mAh.
Koptelefoon. Bluetooth Verbinding. 3,5 mm Jack Aansluiting. Batterij 300 mAh.

20 x 18 x 8 cm 20 Print Code: F(1)



New



Curney 20288

Headphones. Bluetooth Connection. 3,5 mm Jack Socket. Battery 150 mAh.
Kopfhörer: Bluetooth Anschluss. 3,5 mm Klinkestecker. Batterie 150 mAh.
Écouteurs. Connexion Bluetooth. Connexion Jack 3,5 mm. Batterie 150 mAh.
Koptelefoon. Bluetooth Verbinding. 3,5 mm Jack Aansluiting. Batterij 150 mAh.

20 x 16,5 x 8 cm 20 Print Code: F(1)



Treiko 6627



Headphones. Bamboo/ ABS. Bluetooth Connection. 3,5 mm Jack Socket. Battery 200 mAh.
Kopfhörer: Bambus/ ABS. Bluetooth Anschluss. 3,5 mm Klinkestecker. Batterie 200 mAh.
Écouteurs. Bambou/ ABS. Connexion Bluetooth. Connexion Jack 3,5 mm. Batterie 200 mAh.
Koptelefoon. Bamboe/ ABS. Bluetooth Verbinding. 3,5 mm Jack Aansluiting. Batterij 200 mAh.

17,5 x 20,5 x 9 cm 20 Print Code: F(1), L2



Datrex 6510



Headphones. Wheat Straw/ ABS. Bluetooth Connection. 3,5 mm Jack Socket. Battery 400 mAh.
Kopfhörer: Weizenstroh/ ABS. Bluetooth Anschluss. 3,5 mm Klinkestecker. Batterie 400 mAh.
Écouteurs. Paille de Blé/ ABS. Connexion Bluetooth. Connexion Jack 3,5 mm. Batterie 400 mAh.
Koptelefoon. Tarwestro/ ABS. Bluetooth Verbinding. 3,5 mm Jack Aansluiting. Batterij 400 mAh.

17 x 18,5 x 7,5 cm 20 / 10 Print Code: F(1)



Special Gamers

New



Thrym 20863

Gamer Set. Multicolour Led Lights. USB Connection. Keyboard. Mouse Optical. Headphones 3,5 mm Jack Socket. Mousepad Polyester/Silicone, Anti-Slip.

Gamer Set. Mehrfarbige Led Lichter. USB Anschluss. Tastatur. Maus Optisch. Kopfhörer 3,5 mm Klinkestecker. Mauspad Polyester/Silikon, Rutschfest.

Set Gamer. Lumières Led Multicolor. Connexion USB. Clavier. Souris Optique. Écouteurs Connexion Jack 3,5 mm. Tapis Souris Polyester/Silicone, Antidérapant.

Gamer Set. Meerkleurige Led Lichten. USB Verbinding. Toetsenbord. Muis Optisch. Koptelefoon 3,5 mm Jack Aansluiting. Muispad Polyester/Siliconen, Anti-Slip.

43.9 x 3.2 x 12.6 cm 10 Print Code: F(1)



New

Valdy 20864

Mixer. USB Connection. Mischpult. USB Anschluss. Table de Mixage. Connexion USB. Mengpaneel. USB Verbinding.

16.3 x 5 x 14 cm 20 Print Code: G(1)



New

Densha 20877

Condenser Microphone. Multicolour Led Lights. USB Connection. Stand and Noise Reducer Included. Kondensatormikrofoon. Mehrfarbige Led Lichter. USB Anschluss. Halterung und Geräuschreduzierer Inklusiv. Microphone à Condensateur. Lumières Led Multicolores. Connexion USB. Support et Réducteur de Bruit Inclus. Condensatormicrofoon. Meerkleurige Led Lichten. USB Verbinding. Houder en Geluïdsdempers Inbegrepen.

16.5 x 23 x 16 cm 20 Print Code: F(1)

Kristen 1081

Ring Light with Tripod. Extendable. 120 Leds. 3 Light Modes. Adjustable Brightness. USB Connection. Stativ-Ringlicht. Ausziehbar. 120 Leds. 3 Lichtpositionen. Einstellbare Lichtintensität. USB Anschluss. Trépied Anneau Lumineux. Extensible. 120 Leds. 3 Modes de Lumière. Lumière à Intensité Réglable. Connexion USB. Driepoot Ringlicht. Verlengbaar. 120 Leds. 3 Licht Posities. Lamp met Instelbare Lichtintensiteit. USB Verbinding.

30 x 26 x 34.5 cm 10 Print Code: F(1)



Sophie 20263

Karaoke Speaker. Bluetooth Connection. Sound Power 5W. Battery 1200 mAh. Microphone Included.

Karaoke Lautsprecher. Bluetooth Anschluss. Schallleistung 5W. Batterie 1200 mAh. Mikrofon Inklusiv.

Haut-Parleurs Karaoke. Connexion Bluetooth. Puissance Sonore 5W. Batterie 1200 mAh. Microphone Incluse.

Karaoke Luidspreker. Bluetooth Verbinding. Geluidsvermogen 5W. Batterij 1200 mAh. Microfoon Inclusief.

13.5 x 14.3 x 7 cm 20 / 10 Print Code: E(4)



Sinfonyx 20871

Speaker Microphone. Multicolour Led Lights. Bluetooth Connection. Sound Power 5W. Battery 1,200 mAh.

Lautsprecher Mikrofon. Mehrfarbige Led Lichter. Bluetooth Anschluss. Schallleistung 5W. Batterie 1,200 mAh.

Microphone Haut-Parleurs. Lumières Led Multicolores. Connexion Bluetooth. Puissance Sonore 5W. Batterie 1,200 mAh.

Speaker Microfoon. Meerkleurige Led Lichten. Bluetooth Verbinding. Geluidsvermogen 5W. Batterij 1,200 mAh.

Ø 9 x 22 cm 25 Print Code: E(4)



Walén 1998

Speaker. 5 Multicolour Light Modes. Bluetooth Connection. Sound Power 5W. Battery 1,200 mAh.

Lautsprecher. 5 Mehrfarbige Lichtpositionen. Bluetooth Anschluss. Schallleistung 5W. Batterie 1,200 mAh.

Haut-Parleur. 5 Modes de Lumière Multicolore. Connexion Bluetooth. Puissance Sonore 5W. Batterie 1,200 mAh.

Luidspreker. 5 Meerkleurige Licht Posities. Bluetooth Verbinding. Geluidsvermogen 5W. Batterij 1,200 mAh.

10.1 x 15.5 x 5 cm 40 / 20 Print Code: L1



Roby 1969

Speaker. Polyester. 6 Multicolour Light Modes. Bluetooth Connection. Sound Power 5Wx2. Battery 1200 mAh.

Lautsprecher. Polyester. 6 Mehrfarbige Lichtpositionen. Bluetooth Anschluss. Schallleistung 5Wx2. Batterie 1200 mAh.

Haut-Parleur. Polyester. 6 Modes de Lumière Multicolore. Connexion Bluetooth. Puissance Sonore 5Wx2. Batterie 1200 mAh.

Luidspreker. Polyester. 6 Meerkleurige Licht Posities. Bluetooth Verbinding. Geluidsvermogen 5Wx2. Batterij 1200 mAh.

Ø 7.5 x 18.6 cm 20 / 10 Print Code: L1





New

USB▷
USB PLAYER

Vinilux 21018

Record Player. Wood. Bluetooth Connection. Sound Power 3Wx2. Battery 1200 mAh.
Plattenspieler. Holz. Bluetooth Anschluss. Schallleistung 3Wx2. Batterie 1200 mAh.
Tourne-Disque. Bois. Connexion Bluetooth. Puissance Sonore 3Wx2. Batterie 1200 mAh.
Platenspeler. Hout. Bluetooth Verbinding. Geluidsvermogen 3Wx2. Batterij 1200 mAh.

📏 35 x 12 x 25.5 cm 📦 2 🗣️ Print Code: K(1), L3



Zaphir 1144



Charger Speaker. Bamboo. Wireless 10W. Induction Connection. Sound Power 3Wx2. Battery 1.200 mAh.
Ladegerät Lautsprecher. Bambus. Drahtlos 10W. Induktion Anschluss. Schallleistung 3Wx2. Batterie 1.200 mAh.
Haut-Parleurs Chargeur. Bambou. Sans Fil 10W. Connexion par Induction. Puissance Sonore 3Wx2. Batterie 1.200 mAh.
Oplader Luidspreker. Bamboe. Draadloos 10W. Inductie Verbinding. Geluidsvermogen 3Wx2. Batterij 1.200 mAh.

📏 14.5 x 7.2 x 9.1 cm 📦 20 🗣️ Print Code: E(4), L2

Article with FSC™ seal. The FSC™ (Forest Stewardship Council) certification is a mechanism that allows to verify and accredit that the raw material of forest origin used by the industry comes from forests managed according to sustainability and human rights criteria, concerned about the loss and degradation of the planet's forests.



Laurens 1426

Speaker. Bamboo. Solar Charging. Bluetooth Connection. Sound Power 3W. Battery 400 mAh.
Lautsprecher. Bambus. Solarladung. Bluetooth Anschluss. Schallleistung 3W. Batterie 400 mAh.
Haut-Parleur. Bambou. Charge Solaire. Connexion Bluetooth. Puissance Sonore 3W. Batterie 400 mAh.
Luidspreker. Bamboe. Zonnelading. Bluetooth Verbinding. Geluidsvermogen 3W. Batterij 400 mAh.

📏 9.5 x 3.8 x 6.5 cm 📦 50 / 25 🗣️ Print Code: E(4), L2, W



The mark of responsible forestry

LOOK FOR OUR FSC
CERTIFIED PRODUCTS



Blarak 1971

Speaker: Polyester RPET/ Bamboo. Bluetooth Connection. Sound Power 3W. Battery 300 mAh.

Lautsprecher: Polyester RPET/ Bambus. Bluetooth Anschluss. Schallleistung 3W. Batterie 300 mAh.

Haut-Parleur: Polyester RPET/ Bambou. Connexion Bluetooth. Puissance Sonore 3W. Batterie 300 mAh.

Luidspreker: Polyester RPET/ Bamboe. Bluetooth Verbinding. Geluidsvermogen 3W. Batterij 300 mAh.

📏 Ø 5.3 x 6.1 cm 📦 50 / 25 🗣️ Print Code: F(1), N(8)



Boitok 20293

Speaker: Felt RPET/ Bamboo. Bluetooth Connection. Sound Power 3W. Battery 300 mAh.

Lautsprecher: Filtz RPET/ Bambus. Bluetooth Anschluss. Schallleistung 3W. Batterie 300 mAh.

Haut-Parleur: Feutrine RPET/ Bambou. Connexion Bluetooth. Puissance Sonore 3W. Batterie 300 mAh.

Luidspreker: Vilt RPET/ Bamboe. Bluetooth Verbinding. Geluidsvermogen 3W. Batterij 300 mAh.

📏 Ø 6 x 6.3 cm 📦 50 / 25 🗣️ Print Code: L1



Dorkin 1974

Speaker: Organic Hemp/ Wood. Bluetooth Connection. Sound Power 3W. Battery 300 mAh.

Lautsprecher: Organische Hanf/ Holz. Bluetooth Anschluss. Schallleistung 3W. Batterie 300 mAh.

Haut-Parleur: Chanvre Organique/ Bois. Connexion Bluetooth. Puissance Sonore 3W. Batterie 300 mAh.

Luidspreker: Organisch Hennep/ Hout. Bluetooth Verbinding. Geluidsvermogen 3W. Batterij 300 mAh.

📏 5.6 x 7 x 5.6 cm 📦 50 / 25 🗣️ Print Code: E(4)



Teoden 1143

Speaker: Bamboo. Bluetooth Connection. Sound Power 3W. Battery 500 mAh.

Lautsprecher: Bambus. Bluetooth Anschluss. Schallleistung 3W. Batterie 500 mAh.

Haut-Parleur: Bambou. Connexion Bluetooth. Puissance Sonore 3W. Batterie 500 mAh.

Luidspreker: Bamboe. Bluetooth Verbinding. Geluidsvermogen 3W. Batterij 500 mAh.

📏 6 x 6 x 6.2 cm 📦 50 / 25 🗣️ Print Code: E(4), L2, W



Kiefer 20262

Speaker: Bamboo/ Cotton. Bluetooth Connection. Sound Power 3W. Battery 300 mAh.

Lautsprecher: Bambus/ Baumwolle. Bluetooth Anschluss. Schallleistung 3W. Batterie 300 mAh.

Haut-Parleur: Bambou/ Coton. Connexion Bluetooth. Puissance Sonore 3W. Batterie 300 mAh.

Luidspreker: Bamboe/ Katoen. Bluetooth Verbinding. Geluidsvermogen 3W. Batterij 300 mAh.

📏 6.5 x 5.5 x 6.5 cm 📦 100 / 50 🗣️ Print Code: E(4), L2



Kepir 6666

Speaker: Wheat Straw/ ABS/ Bamboo. Bluetooth Connection. Sound Power 3W. Battery 500 mAh.

Lautsprecher: Weizenstroh/ ABS/ Bambus. Bluetooth Anschluss. Schallleistung 3W. Batterie 500 mAh.

Haut-Parleur: Paille de Blé/ ABS/ Bambou. Connexion Bluetooth. Puissance Sonore 3W. Batterie 500 mAh.

Luidspreker: Tarwestro/ ABS/ Bamboe. Bluetooth Verbinding. Geluidsvermogen 3W. Batterij 500 mAh.

📏 7.4 x 7 x 4.5 cm 📦 50 / 25 🗣️ Print Code: E(4), L1



Yois 6507

Speaker. Led Lights. 2 Light Modes. Adjustable Brightness. Bluetooth Connection. Sound Power 3W. Battery 1200 mAh.
Lautsprecher. Led Lichten. 2 Lichtpositionen. Einstellbare Lichtintensität. Bluetooth Anschluss. Schallleistung 3W. Batterie 1200 mAh.

Haut-Parleur. Lumières Led. 2 Modes de Lumière. Lumière à Intensité Réglable. Connexion Bluetooth. Puissance Sonore 3W. Batterie 1200 mAh.

Luidspreker. Led Lichten. 2 Licht Posities. Lamp met Instelbare Lichtintensiteit. Bluetooth Verbinding. Geluidsvermogen 3W. Batterij 1200 mAh.

📏 12 x 15 x 12 cm 📦 20 🖨️ Print Code: F(1), L1



Nalow 1146

Speaker. ABS/ Bamboe. Multicolour Smart Leds. 3 Light Modes. Adjustable Brightness. Bluetooth Connection. Sound Power 3W. Battery 1200 mAh.
Lautsprecher. ABS/ Bambus. Mehrfarbige Intelligente Leds. 3 Lichtpositionen. Einstellbare Lichtintensität. Bluetooth Anschluss. Schallleistung 3W. Batterie 1200 mAh.

Haut-Parleur. ABS/ Bamboe. Leds Intelligentes Multicolores. 3 Modes de Lumière. Lumière à Intensité Réglable. Connexion Bluetooth. Puissance Sonore 3W. Batterie 1200 mAh.

Luidspreker. ABS/ Bamboe. Meerkleurige Smart Leds. 3 Licht Posities. Lamp met Instelbare Lichtintensiteit. Bluetooth Verbinding. Geluidsvermogen 3W. Batterij 1200 mAh.

📏 Ø 9,6 x 12 cm 📦 20 🖨️ Print Code: F(1), L1



Durbal 1989

Speaker. Bamboo. Led Lights. Bluetooth Connection. Sound Power 3W. Battery 300 mAh.
Lautsprecher. Bambus. Led Lichten. Bluetooth Anschluss. Schallleistung 3W. Batterie 300 mAh.

Haut-Parleur. Bamboe. Lumières Led. Connexion Bluetooth. Puissance Sonore 3W. Batterie 300 mAh.

Luidspreker. Bamboe. Led Lichten. Bluetooth Verbinding. Geluidsvermogen 3W. Batterij 300 mAh.

📏 Ø 7,5 x 5,5 cm 📦 40 / 20 🖨️ Print Code: E(4), L1



Kevil 6528

Speaker. Bamboo. Multicolour Smart Leds. 2 Light Modes. Bluetooth Connection. Sound Power 3W. Battery 300 mAh.
Lautsprecher. Bambus. Mehrfarbige Intelligente Leds. 2 Lichtpositionen. Bluetooth Anschluss. Schallleistung 3W. Batterie 300 mAh.

Haut-Parleur. Bamboe. Leds Intelligentes Multicolores. 2 Modes de Lumière. Connexion Bluetooth. Puissance Sonore 3W. Batterie 300 mAh.

Luidspreker. Bamboe. Meerkleurige Smart Leds. 2 Licht Posities. Bluetooth Verbinding. Geluidsvermogen 3W. Batterij 300 mAh.

📏 Ø 6,4 x 10,6 cm 📦 50 / 25 🖨️ Print Code: E(4), L1



BLUETOOTH SPEAKER

New

New



Bitels 20848



HANDS-FREE



MICRO SD

((FM))
RADIO

LINE IN

Speaker. Bluetooth Connection. Sound Power 5W. Battery 800 mAh.
Lautsprecher. Bluetooth Anschluss. Schallleistung 5W. Batterie 800 mAh.
Haut-Parleurs. Connexion Bluetooth. Puissance Sonore 5W. Batterie 800 mAh.
Luidspreker. Bluetooth Verbinding. Geluidsvermogen 5W. Batterij 800 mAh.

11.4 x 6.3 x 11 cm 30 Print Code: E(4)

Florens 21020



MICRO SD

((FM))
RADIO

Speaker. Bluetooth Connection. Sound Power 3W. Battery 500 mAh.
Lautsprecher. Bluetooth Anschluss. Schallleistung 3W. Batterie 500 mAh.
Haut-Parleurs. Connexion Bluetooth. Puissance Sonore 3W. Batterie 500 mAh.
Luidspreker. Bluetooth Verbinding. Geluidsvermogen 3W. Batterij 500 mAh.

9.1 x 7 x 6 cm 40 / 20 Print Code: E(4)



Sotep RCS 1984



Speaker: Recycled Leather/ Recycled ABS. Bluetooth Connection. Sound Power 3W. Battery 400 mAh.

Lautsprecher: Recycling Leder/ Recycling ABS. Bluetooth Anschluss. Schallleistung 3W. Batterie 400 mAh.

Haut-Parleur: Cuir Recyclé/ ABS Recyclé. Connexion Bluetooth. Puissance Sonore 3W. Batterie 400 mAh.

Luidspreker: Gerecycled Leer/ Gerecycled ABS. Bluetooth Verbinding. Geluidsvermogen 3W. Batterij 400 mAh.

Ø 6.2 x 6.4 cm 50 Print Code: E(4), L1



Yuxter 6738

Speaker: Cork. Bluetooth Connection. Sound Power 3W. Battery 300 mAh.

Lautsprecher: Kork. Bluetooth Anschluss. Schallleistung 3W. Batterie 300 mAh.

Haut-Parleur: Liège. Connexion Bluetooth. Puissance Sonore 3W. Batterie 300 mAh.

Luidspreker: Kurk. Bluetooth Verbinding. Geluidsvermogen 3W. Batterij 300 mAh.

Ø 6.2 x 7.5 cm 50 / 25 Print Code: E(4), L1



Mirintex 1966

Speaker: Cork/ Bamboo. Bluetooth Connection. Sound Power 3W. Battery 300 mAh.

Lautsprecher: Kork/ Bambus. Bluetooth Anschluss. Schallleistung 3W. Batterie 300 mAh.

Haut-Parleur: Liège/ Bambou. Connexion Bluetooth. Puissance Sonore 3W. Batterie 300 mAh.

Luidspreker: Kurk/ Bamboe. Bluetooth Verbinding. Geluidsvermogen 3W. Batterij 300 mAh.

Ø 6.5 x 7 cm 50 / 25 Print Code: E(4), L1



Donny 1192

Speaker: Polyester RPET. Bluetooth Connection. Sound Power 3W. Battery 300 mAh.

Lautsprecher: Polyester RPET. Bluetooth Anschluss. Schallleistung 3W. Batterie 300 mAh.

Haut-Parleur: Polyester RPET. Connexion Bluetooth. Puissance Sonore 3W. Batterie 300 mAh.

Luidspreker: Polyester RPET. Bluetooth Verbinding. Geluidsvermogen 3W. Kabel/Batterij 300 mAh.

Ø 6 x 5.3 cm 50 / 25 Print Code: E(4), N(6)



Piler 6700

Speaker: Limestone Cement/ Bamboo. Bluetooth Connection. Sound Power 3W. Battery 300 mAh.

Lautsprecher: Kalksteinzement/ Bambus. Bluetooth Anschluss. Schallleistung 3W. Batterie 300 mAh.

Haut-Parleur: Ciment Calcaire/ Bambou. Connexion Bluetooth. Puissance Sonore 3W. Batterie 300 mAh.

Luidspreker: Kalksteen Cement/ Bamboe. Bluetooth Verbinding. Geluidsvermogen 3W. Batterij 300 mAh.

Ø 7.2 x 6.8 cm 30 / 15 Print Code: E(4), L1



Seynol 6745

Speaker: Limestone Cement/ Cork. Bluetooth Connection. Sound Power 3W. Battery 300 mAh.

Lautsprecher: Kalksteinzement/ Kork. Bluetooth Anschluss. Schallleistung 3W. Batterie 300 mAh.

Haut-Parleur: Ciment Calcaire/ Liège. Connexion Bluetooth. Puissance Sonore 3W. Batterie 300 mAh.

Luidspreker: Kalksteen Cement/ Kurk. Bluetooth Verbinding. Geluidsvermogen 3W. Batterij 300 mAh.

7.1 x 7.1 x 5.8 cm 20 Print Code: E(4), L1



Kaltun 6143



Speaker: Bamboo/ ABS. Bluetooth Connection. Sound Power 3W. Battery 300 mAh.

Lautsprecher: Bambus/ ABS. Bluetooth Anschluss. Schallleistung 3W. Batterie 300 mAh.

Haut-Parleur: Bambou/ ABS. Connexion Bluetooth. Puissance Sonore 3W. Batterie 300 mAh.

Luidspreker: Bamboe/ ABS. Bluetooth Verbinding. Geluidsvermogen 3W. Batterij 300 mAh.

📏 Ø 6 x 5.1 cm 📦 50 / 25 🗣️ Print Code: E(4), L1



Cayren 6540

Speaker: Wheat Straw/ ABS. Bluetooth Connection. Sound Power 3W. Battery 300 mAh.

Lautsprecher: Weizenstroh/ ABS. Bluetooth Anschluss. Schallleistung 3W. Batterie 300 mAh.

Haut-Parleur: Paille de Blé/ ABS. Connexion Bluetooth. Puissance Sonore 3W. Batterie 300 mAh.

Luidspreker: Tarwestro/ ABS. Bluetooth Verbinding. Geluidsvermogen 3W. Batterij 300 mAh.

📏 Ø 6 x 5 cm 📦 50 / 25 🗣️ Print Code: E(4)



Denzel 6181



Speaker: Bamboo/ ABS. Bluetooth Connection. Sound Power 3W. Battery 300 mAh.

Lautsprecher: Bambus/ ABS. Bluetooth Anschluss. Schallleistung 3W. Batterie 300 mAh.

Haut-Parleur: Bambou/ ABS. Connexion Bluetooth. Puissance Sonore 3W. Batterie 300 mAh.

Luidspreker: Bamboe/ ABS. Bluetooth Verbinding. Geluidsvermogen 3W. Batterij 300 mAh.

📏 Ø 7.3 x 4.3 cm 📦 100 / 50 🗣️ Print Code: E(4), L1



Crapin 6930

Speaker: Recycled Cardboard/ Wheat Straw/ ABS. Bluetooth Connection. Sound Power 3W. Battery 300 mAh.

Lautsprecher: Recycling Pappe/ Weizenstroh/ ABS. Bluetooth Anschluss. Schallleistung 3W. Batterie 300 mAh.

Haut-Parleur: Carton Recyclé/ Paille de Blé/ ABS. Connexion Bluetooth. Puissance Sonore 3W. Batterie 300 mAh.

Luidspreker: Gerecycled Karton/ Tarwestro/ ABS. Bluetooth Verbinding. Geluidsvermogen 3W. Batterij 300 mAh.

📏 Ø 7 x 5 cm 📦 50 / 25 🗣️ Print Code: E(4)



Nerel 6743

Speaker: Wheat Straw/ ABS/ Cork. Bluetooth Connection. Sound Power 3W. Battery 300 mAh.

Lautsprecher: Weizenstroh/ ABS/ Kork. Bluetooth Anschluss. Schallleistung 3W. Batterie 300 mAh.

Haut-Parleur: Paille de Blé/ ABS/ Liège. Connexion Bluetooth. Puissance Sonore 3W. Batterie 300 mAh.

Luidspreker: Tarwestro/ ABS/ Kurk. Bluetooth Verbinding. Geluidsvermogen 3W. Batterij 300 mAh.

📏 Ø 6 x 5 cm 📦 50 / 25 🗣️ Print Code: E(4), L1



Dadil 6541



Speaker: Wheat Straw/ ABS. Bluetooth Connection. Sound Power 3W. Battery 300 mAh.

Lautsprecher: Weizenstroh/ ABS. Bluetooth Anschluss. Schallleistung 3W. Batterie 300 mAh.

Haut-Parleur: Paille de Blé/ ABS. Connexion Bluetooth. Puissance Sonore 3W. Batterie 300 mAh.

Luidspreker: Tarwestro/ ABS. Bluetooth Verbinding. Geluidsvermogen 3W. Batterij 300 mAh.

📏 8.6 x 7.2 x 3.9 cm 📦 50 / 25 🗣️ Print Code: E(4)



New

03



01

02

19

Kucher 21015

Speaker. Led Lights. Bluetooth Connection. Sound Power 3W. Battery 300 mAh.
Lautsprecher. Led Lichter. Bluetooth Anschluss. Schallleistung 3W. Batterie 300 mAh.
Haut-Parleurs. Lumières Led. Connexion Bluetooth. Puissance Sonore 3W. Batterie 300 mAh.
Luidspreker. Led Lichten. Bluetooth Verbinding. Geluidsvermogen 3W. Batterij 300 mAh.

📏 Ø 6.4 x 6.2 cm 📦 50 / 25 📄 Print Code: E(4), L1

SPECIAL LASER ENGRAVING WHITE LIGHT LOGO



This bluetooth speaker with illuminated interior has an external coating specially designed for laser engraving, with which you will see your advertising or brand illuminated with white light.



19



09

04

23

03

02

01

11

Viancos 5775

Speaker. Led Lights. Bluetooth Connection. Sound Power 3W. Battery 300 mAh.
Lautsprecher. Led Lichter. Bluetooth Anschluss. Schallleistung 3W. Batterie 300 mAh.
Haut-Parleur. Lumières Led. Connexion Bluetooth. Puissance Sonore 3W. Batterie 300 mAh.
Luidspreker. Led Lichten. Bluetooth Verbinding. Geluidsvermogen 3W. Batterij 300 mAh.

📏 Ø 6.2 x 5.1 cm 📦 50 📄 Print Code: E(4), L1



MULTICOLOR
LIGHT

Stockel 6086



Speaker. Multicolour Smart Leds. 3 Light Modes. Bluetooth Connection. Sound Power 3W. Battery 300 mAh.
Lautsprecher. Mehrfarbige Intelligente Leds. 3 Lichtpositionen. Bluetooth Anschluss. Schallleistung 3W. Batterie 300 mAh.
Haut-Parleur. Leds Intelligentes Multicolores. 3 Modes de Lumière. Connexion Bluetooth. Puissance Sonore 3W. Batterie 300 mAh.
Luidspreker. Meerkleurige Smart Leds. 3 Licht Posities. Bluetooth Verbinding. Geluidsvermogen 3W. Batterij 300 mAh.

📏 Ø 6 x 6 cm 📦 50 📄 Print Code: E(4)





Lops 21103

Speaker. Recycled Aluminium/ Bamboo. Bluetooth Connection. Sound Power 3W. Battery 300 mAh.
Lautsprecher. Recycling Aluminium/ Bambus. Bluetooth Anschluss. Schallleistung 3W. Batterie 300 mAh.
Haut-Parleur. Aluminium Recyclé/ Bambou. Connexion Bluetooth. Puissance Sonore 3W. Batterie 300 mAh.
Luidspreker. Gerecycled Aluminium/ Bamboe. Bluetooth Verbinding. Geluidsvermogen 3W. Batterij 300 mAh.

📏 Ø 7 x 6 cm 📦 50 / 25 🗑️ Print Code: E(1), L1

Moore 20256

Speaker. Recycled Aluminium/ Cork. Bluetooth Connection. Sound Power 3W. Battery 300 mAh.
Lautsprecher. Recycling Aluminium/ Kork. Bluetooth Anschluss. Schallleistung 3W. Batterie 300 mAh.
Haut-Parleur. Aluminium Recyclé/ Liège. Connexion Bluetooth. Puissance Sonore 3W. Batterie 300 mAh.
Luidspreker. Gerecycled Aluminium/ Kurk. Bluetooth Verbinding. Geluidsvermogen 3W. Batterij 300 mAh.

📏 Ø 7 x 5.6 cm 📦 50 / 25 🗑️ Print Code: E(1), L1

Recycled 
Aluminium



Skind 1997

Speaker. Recycled Aluminium. Bluetooth Connection. Sound Power 3W. Battery 450 mAh.
Lautsprecher. Recycling Aluminium. Bluetooth Anschluss. Schallleistung 3W. Batterie 450 mAh.
Haut-Parleur. Aluminium Recyclé. Connexion Bluetooth. Puissance Sonore 3W. Batterie 450 mAh.
Luidspreker. Gerecycled Aluminium. Bluetooth Verbinding. Geluidsvermogen 3W. Batterij 450 mAh.

📏 Ø 6.9 x 4.3 cm 📦 50 / 25 🗑️ Print Code: E(1), L1



Hiwent 21199

Speaker. Recycled Aluminium/ Bamboo. Bluetooth Connection. Sound Power 3W. Battery 300 mAh.
Lautsprecher. Recycling Aluminium/ Bambus. Bluetooth Anschluss. Schallleistung 3W. Batterie 300 mAh.
Haut-Parleur. Aluminium Recyclé/ Bambou. Connexion Bluetooth. Puissance Sonore 3W. Batterie 300 mAh.
Luidspreker. Gerecycled Aluminium/ Bamboe. Bluetooth Verbinding. Geluidsvermogen 3W. Batterij 300 mAh.

📏 Ø 6.8 x 3.5 cm 📦 50 / 25 🗑️ Print Code: E(1), L1



Heston 20855



Speaker: Bluetooth Connection. Sound Power 3W. Battery 200 mAh.
Lautsprecher: Bluetooth Anschluss. Schallleistung 3W. Batterie 200 mAh.
Haut-Parleurs: Connexion Bluetooth. Puissance Sonore 3W. Batterie 200 mAh.
Luidspreker: Bluetooth Verbinding. Geluidsvermogen 3W. Batterij 200 mAh.

📏 5.5 x 5.5 x 7.3 cm 📖 100 / 50 🖨️ Print Code: F(1), L1



Wanap 6506



Speaker: Bluetooth Connection. Sound Power 3W. Battery 200 mAh.
Lautsprecher: Bluetooth Anschluss. Schallleistung 3W. Batterie 200 mAh.
Haut-Parleur: Connexion Bluetooth. Puissance Sonore 3W. Batterie 200 mAh.
Luidspreker: Bluetooth Verbinding. Geluidsvermogen 3W. Batterij 200 mAh.

📏 Ø 5.2 x 5.9 cm 📖 100 / 50 🖨️ Print Code: F(1), L1



Rariax 4929



Speaker: Bluetooth Connection. Sound Power 3W. Battery 300 mAh.
Lautsprecher: Bluetooth Anschluss. Schallleistung 3W. Batterie 300 mAh.
Haut-Parleur: Connexion Bluetooth. Puissance Sonore 3W. Batterie 300 mAh.
Luidspreker: Bluetooth Verbinding. Geluidsvermogen 3W. Batterij 300 mAh.

📏 Ø 8.5 x 5.5 cm 📖 50 🖨️ Print Code: F(1)





04



Martins 4936



Speaker. Metal. Bluetooth Connection. Sound Power 3W. Battery 300 mAh.
 Lautsprecher. Metall. Bluetooth Anschluss. Schallleistung 3W. Batterie 300 mAh.
 Haut-Parleur. Métal. Connexion Bluetooth. Puissance Sonore 3W. Batterie 300 mAh.
 Luidspreker. Metaal. Bluetooth Verbinding. Geluidsvermogen 3W. Batterij 300 mAh.

Ø 5.9 x 5 cm

50 / 25

Print Code: E(4), L1



19



Braiss 4628



Speaker. Bluetooth Connection. Sound Power 3W. Battery 200 mAh.
 Lautsprecher. Bluetooth Anschluss. Schallleistung 3W. Batterie 200 mAh.
 Haut-Parleur. Connexion Bluetooth. Puissance Sonore 3W. Batterie 200 mAh.
 Luidspreker. Bluetooth Verbinding. Geluidsvermogen 3W. Batterij 200 mAh.

Ø 6 x 7.5 cm

50

Print Code: F(1)



08



06

18

02

Rumok 1999

Speaker. Bluetooth Connection. Sound Power 3W. Battery 300 mAh.
 Lautsprecher. Bluetooth Anschluss. Schallleistung 3W. Batterie 300 mAh.
 Haut-Parleur. Connexion Bluetooth. Puissance Sonore 3W. Batterie 300 mAh.
 Luidspreker. Bluetooth Verbinding. Geluidsvermogen 3W. Batterij 300 mAh.

Ø 7.5 x 5.5 cm

50 / 25

Print Code: E(1)



08



01

03

04

07

19

Kafin 6413



Speaker. Polyester. Bluetooth Connection. Sound Power 3W. Battery 400 mAh.
 Lautsprecher. Polyester. Bluetooth Anschluss. Schallleistung 3W. Batterie 400 mAh.
 Haut-Parleur. Polyester. Connexion Bluetooth. Puissance Sonore 3W. Batterie 400 mAh.
 Luidspreker. Polyester. Bluetooth Verbinding. Geluidsvermogen 3W. Batterij 400 mAh.

11.1 x 8.3 x 4.1 cm

50

Print Code: E(1), N(8)



Sheilax 20253

((15W))
WIRELESS CHARGER

Multifunction Lamp. Bamboo. 2 Leds. Speaker Bluetooth Connection. Sound Power 5W. Battery 400 mAh. Wireless Charger 15W. USB Connection. Multifunktion Lampe. Bambus. 2 Leds. Lautsprecher Bluetooth Anschluss. Schallleistung 5W. Batterie 400 mAh. Drahtlos Ladegerät 15W. USB Anschluss.

Lampe Multifonction. Bambou. 2 Leds. Haut-Parleurs Connexion Bluetooth. Puissance Sonore 5W. Batterie 400 mAh. Chargeur Sans Fil 15W. Connexion USB.

Multifunctioneel Lamp. Bamboe. 2 Leds. Luidspreker Bluetooth Verbinding. Geluidsvermogen 5W. Batterij 400 mAh. Draadloos Oplader 15W. USB Verbinding.

Ø 8 x 8 cm 50 Print Code: E(1), L2



Zakrox 6776

Charger Speaker. Bamboo/ ABS. Wireless 5W. Bluetooth Connection. Sound Power 3W. Battery 400 mAh.

Ladegerät Lautsprecher. Bambus/ ABS. Drahtlos 5W. Bluetooth Anschluss. Schallleistung 3W. Batterie 400 mAh.

Haut-Parleurs Chargeur. Bambou/ ABS. Sans Fil 5W. Connexion Bluetooth. Puissance Sonore 3W. Batterie 400 mAh.

Oplader Luidspreker. Bamboe/ ABS. Draadloos 5W. Bluetooth Verbinding. Geluidsvermogen 3W. Batterij 400 mAh.

Ø 7.4 x 6.8 cm 50 Print Code: E(1), L1



Trecam 6546

HANDS-FREE
LINE IN

Charger Speaker. Wheat Straw/ ABS/ Bamboo. Wireless 10W. Bluetooth Connection. Sound Power 5W. Battery 1,200 mAh.

Ladegerät Lautsprecher. Weizenstroh/ ABS/ Bambus. Drahtlos 10W. Bluetooth Anschluss. Schallleistung 5W. Batterie 1,200 mAh.

Haut-Parleurs Chargeur. Paille de Blé/ ABS/ Bambou. Sans Fil 10W. Connexion Bluetooth. Puissance Sonore 5W. Batterie 1,200 mAh.

Oplader Luidspreker. Tarwestro/ ABS/ Bamboe. Draadloos 10W. Bluetooth Verbinding. Geluidsvermogen 5W. Batterij 1,200 mAh.

16 x 5.9 x 6 cm 30 / 15 Print Code: F(1), L2



New

((15W))
WIRELESS CHARGER

Cedric 20254

Charger Speaker. Polyester 300D RPET/ Bamboo. Wireless 15W. Bluetooth Connection. Sound Power 5W. Battery 1200 mAh.

Ladegerät Lautsprecher. Polyester 300D RPET/ Bambus. Drahtlos 15W. Bluetooth Anschluss. Schallleistung 5W. Batterie 1200 mAh.

Haut-Parleurs Chargeur. Polyester 300D RPET/ Bambou. Sans Fil 15W. Connexion Bluetooth. Puissance Sonore 5W. Batterie 1200 mAh.

Oplader Luidspreker. Polyester 300D RPET/ Bamboe. Draadloos 15W. Luidspreker. Bluetooth Verbinding. Geluidsvermogen 5W. Batterij 1200 mAh.

Ø 10.5 x 7.9 cm 40 / 20 Print Code: E(1), L2



ANTONIO MIRO

HANDS-FREE MICRO SD ((FM)) RADIO USB > LINE IN
USB PLAYER

Brenner 7343

Speaker. Bluetooth Connection. Sound Power 3W. Battery 500 mAh.

Lautsprecher. Bluetooth Anschluss. Schallleistung 3W. Batterie 500 mAh.

Haut-Parleur. Connexion Bluetooth. Puissance Sonore 3W. Batterie 500 mAh.

Luidspreker. Bluetooth Verbinding. Geluidsvermogen 3W. Batterij 500 mAh.

7.9 x 9 x 7.9 cm 50 Print Code: L2



HANDS-FREE MICRO SD ((FM)) RADIO USB > LINE IN
USB PLAYER

Holsux 7344

Speaker. Bluetooth Connection. Sound Power 8W. Battery 1800 mAh.

Lautsprecher. Bluetooth Anschluss. Schallleistung 8W. Batterie 1800 mAh.

Haut-Parleur. Connexion Bluetooth. Puissance Sonore 8W. Batterie 1800 mAh.

Luidspreker. Bluetooth Verbinding. Geluidsvermogen 8W. Batterij 1800 mAh.

17 x 17 x 7.5 cm 30 Print Code: L2



WIRELESS
CHARGER

Borstein 1746



Multifunction Lamp, Cork/ ABS. 12 Leds. Flexible. 3 Light Modes. Adjustable Brightness. Speaker Bluetooth Connection. Sound Power 3W. USB Connection. Wireless Charger 10W.
 Multifunktion Lampe, Kork/ ABS. 12 Leds. Flexibel. 3 Lichtpositionen. Einstellbare Lichtintensität. Lautsprecher Bluetooth Anschluss. Schallleistung 3W. USB Anschluss. Drahtlos Ladegerät 10W.
 Lampe Multifonction, Liège/ ABS. 12 Leds. Flexible. 3 Modes de Lumière. Lumière à Intensité Réglable. Haut-Parleurs Connexion Bluetooth. Puissance Sonore 3W. Connexion USB. Chargeur Sans Fil 10W.
 Multifunctioneel Lamp, Kurk/ ABS. 12 Leds. Flexibel. 3 Licht Posities. Lamp met Instelbare Lichtintensiteit. Luidspreker Bluetooth Verbinding. Geluidsvermogen 3W. USB Verbinding. Draadloos Oplader 10W.

📏 Ø 12 x 32,5 cm 📦 20 🗣️ Print Code: F(1), L2

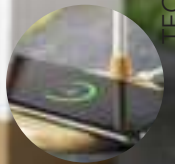

WIRELESS
CHARGER

Lars 1353



Multifunction Lamp, Bamboo. 14 Leds. Flexible. 3 Light Modes. Adjustable Brightness. Speaker Bluetooth Connection. Sound Power 3W. Wireless Charger 10W. USB Connection.
 Multifunktion Lampe, Bambou. 14 Leds. Flexibel. 3 Lichtpositionen. Einstellbare Lichtintensität. Lautsprecher Bluetooth Anschluss. Schallleistung 3W. Drahtlos Ladegerät 10W. USB Anschluss.
 Lampe Multifonction, Bambou. 14 Leds. Flexible. 3 Modes de Lumière. Lumière à Intensité Réglable. Haut-Parleurs Connexion Bluetooth. Puissance Sonore 3W. Chargeur Sans Fil 10W. Connexion USB.
 Multifunctioneel Lamp, Bamboe. 14 Leds. Flexibel. 3 Licht Posities. Lamp met Instelbare Lichtintensiteit. Luidspreker Bluetooth Verbinding. Geluidsvermogen 3W. Draadloos Oplader 10W. USB Verbinding.

📏 Ø 12 x 32,5 cm 📦 20 🗣️ Print Code: F(1), L2

Sadow 1351



Multifunction Lamp, Wheat Straw/ ABS/ Bamboe. 12 Leds. 3 Light Modes. Adjustable Brightness. Speaker Bluetooth Connection. Sound Power 3W. Battery 400 mAh. Wireless Charger 10W. USB Connection.
 Multifunktion Lampe, Weizenstroh/ ABS/ Bamboe. 12 Leds. 3 Lichtpositionen. Einstellbare Lichtintensität. Lautsprecher Bluetooth Anschluss. Schallleistung 3W. Batterie 400 mAh. Drahtlos Ladegerät 10W. USB Anschluss.
 Lampe Multifonction, Paille de Blé/ ABS/ Bamboe. 12 Leds. 3 Modes de Lumière. Lumière à Intensité Réglable. Haut-Parleurs Connexion Bluetooth. Puissance Sonore 3W. Batterie 400 mAh. Chargeur Sans Fil 10W. Connexion USB.
 Multifunctioneel Lamp, Tarwestro/ ABS/ Bamboe. 12 Leds. 3 Licht Posities. Lamp met Instelbare Lichtintensiteit. Luidspreker Bluetooth Verbinding. Geluidsvermogen 3W. Batterij 400 mAh. Draadloos Oplader 10W. USB Verbinding.

📏 11 x 13 x 11,5 cm 📦 20 🗣️ Print Code: E(1), F(1), L2



WIRELESS
CHARGER



Labrum 1352

Charger Lamp. Bamboo/ Aluminium. 52 Leds. 3 Light Modes. Adjustable Brightness. Bluetooth Connection. Wireless 10W. USB Output.

Ladegerät Lampe. Bambus/ Aluminium. 52 Leds. 3 Lichtpositionen. Einstellbare Lichtintensität. Bluetooth Anschluss. Drahtlos 10W. USB Ausgang.
Lampe Chargeur. Bambou/ Aluminium. 52 Leds. 3 Modes de Lumière. Lumière à Intensité Réglable. Connexion Bluetooth. Sans Fil 10W. Sortie USB.
Oplader Lamp. Bamboe/ Aluminium. 52 Leds. 3 Licht Posities. Lamp met Instelbare Lichtintensiteit. Bluetooth Verbinding. Draadloos 10W. USB Output.

23.5 x 18.5 x 8 cm 20 Print Code: F(1), L2



Gregal 20865 (15W)

WIRELESS CHARGER

Charger Lamp. Bamboo. 12 Leds. Flexible. Adjustable Brightness. Wireless Charger 15W. USB Connection.

Ladegerät Lampe. Bambus. 12 Leds. Flexibel. Einstellbare Lichtintensität. Drahtlos Ladegerät 15W. USB Anschluss.

Lampe Chargeur. Bambou. 12 Leds. Flexible. Lumière à Intensité Réglable. Chargeur Sans Fil 15W. Connexion USB.

Oplader Lamp. Bamboe. 12 Leds. Flexibel. Lamp met Instelbare Lichtintensiteit. Draadloos Oplader 15W. USB Verbinding.

12 x 21 x 7.9 cm 50/25 Print Code: F(1), L2



New

Sleya 1145

Charger Lamp. Bamboo. 25 Leds. Foldable. 3 Light Modes. Adjustable Brightness. Bluetooth Connection. Wireless 10W. Output USB.

Ladegerät Lampe. Bambus. 25 Leds. Faltbar. 3 Lichtpositionen. Einstellbare Lichtintensität. Bluetooth Anschluss. Drahtlos 10W. USB Ausgang.

Lampe Chargeur. Bambou. 25 Leds. Pliable. 3 Modes de Lumière. Lumière à Intensité Réglable. Connexion Bluetooth. Sans Fil 10W. Sortie USB.

Oplader Lamp. Bamboe. 25 Leds. Opvouwbaar. 3 Licht Posities. Lamp met Instelbare Lichtintensiteit. Bluetooth Verbinding. Draadloos 10W. USB Output.

25 x 38.5 x 11 cm 20 Print Code: F(1), L2



MULTIFUNCTION LAMP

MULTIFUNCTION ALARM CLOCK



Edres 1988



Multifunction Alarm Clock. Bamboo. Lampe 16 Leds. Foldable. 3 Light Modes. Adjustable Brightness. Wireless Charger 15W. USB Output. USB Connection.

Multifunktion Tischuhr. Bambus. Lampe 16 Leds. Faltbar. 3 Lichtpositionen. Einstellbare Lichtintensität. Drahtlos Ladegerät 15W. USB Ausgang. USB Anschluss.

Horloge Multifonction. Bambou. Lampe 16 Leds. Pliable. 3 Modes de Lumière. Lumière à Intensité Réglable. Chargeur Sans Fil 15W. Sortie USB. Connexion USB.

Multifunctioneel Klok. Bamboe. Lamp 16 Leds. Opvouwbaar. 3 Licht Posities. Lamp met Instelbare Lichtintensiteit. Draadloos Oplader 15W. USB Output. USB Verbinding.

18 x 24 x 8 cm



20



Print Code: F(1), L2



New



Darret 20267



Multifunction Alarm Clock. ABS/ Bamboo. Lamp 6 Leds. Wireless Charger 10W. USB Connection.

Multifunktion Tischuhr. ABS/ Bambus. Lampe 6 Leds. Drahtlos Ladegerät 10W. USB Anschluss.

Horloge Multifonction. ABS/ Bamboe. Lampe 6 Leds. Chargeur Sans Fil 10W. Connexion Bluetooth.

Multifunctioneel Klok. ABS/ Bamboe. Lamp 6 Leds. Draadloos Oplader 10W. USB Verbinding.

13.6 x 16.6 x 7.9 cm



40 / 20



Print Code: F(1)





Evanex 21068



Multifunction Lamp. Aluminium/ ABS. 60 Leds. Foldable. Adjustable Height. 3 Light Modes. Adjustable Brightness. Wireless Charger 10W. USB Connection. Multifunktions Lampe. Aluminium/ ABS. 60 Leds. Faltbar. Höhenverstellbar. 3 Lichtpositionen. Einstellbare Lichtintensität. Drahtlos Ladegerät 10W. USB Anschluss.

Lampe Multifonction. Aluminium/ ABS. 60 Leds. Pliable. Hauteur Réglable. 3 Modes de Lumière. Lumière à Intensité Réglable. Chargeur Sans Fil 10W. Connexion USB.

Multifunctioneel Lamp. Aluminium/ ABS. 60 Leds. Opvooaar. Aanpasbaar Hoogte. 3 Licht Posities. Lamp met Instelbare Lichtintensiteit. Draadloos Oplader 10W. USB Verbinding.

34 x 36 x 15 cm 20 Print Code: F(1)

New



3000 mAh

Cirgux 1427

Multifunction Lamp. Aluminium/ ABS. 28 Leds. Foldable. Adjustable Height. 3 Light Modes. Adjustable Brightness. Wireless Charger 10W. Power Bank 3000 mAh. Type C Input. 1 USB Output.

Multifunktions Lampe. Aluminium/ ABS. 28 Leds. Faltbar. Höhenverstellbar. 3 Lichtpositionen. Einstellbare Lichtintensität. Drahtlos Ladegerät 10W. Power Bank 3000 mAh. Typ C Eingang. 1 USB Ausgang.

Lampe Multifonction. Aluminium/ ABS. 28 Leds. Pliable. Hauteur Réglable. 3 Modes de Lumière. Lumière à Intensité Réglable. Chargeur Sans Fil 10W. Power Bank 3000 mAh. Entrée Type C. 1 Sortie USB.

Multifunctioneel Lamp. Aluminium/ ABS. 28 Leds. Opvooaar. Aanpasbaar Hoogte. 3 Licht Posities. Lamp met Instelbare Lichtintensiteit. Draadloos Oplader 10W. Power Bank 3000 mAh. Typ C Input. 1 USB Output.

7 x 26 x 12 cm 50 Print Code: F(1), L2

Lerex 6268



Multifunction Lamp. 14 Leds. Flexible. 3 Light Modes. Adjustable Brightness. Speaker Bluetooth Connection. Sound Power 3W. USB Connection. Wireless Charger 10W.

Multifunktions Lampe. 14 Leds. Flexibel. 3 Lichtpositionen. Einstellbare Lichtintensität. Lautsprecher Bluetooth Anschluss. Schallleistung 3W. USB Anschluss. Drahtlos Ladegerät 10W.

Lampe Multifonction. 14 Leds. Flexible. 3 Modes de Lumière. Lumière à Intensité Réglable. Haut-Parleurs Connexion Bluetooth. Puissance Sonore 3W. Connexion USB. Chargeur Sans Fil 10W.

Multifunctioneel Lamp. 14 Leds. Flexibel. 3 Licht Posities. Lamp met Instelbare Lichtintensiteit. Luidspreker Bluetooth Verbinding. Geluidsvermogen 3W. USB Verbinding. Draadloos Oplader 10W.

12 x 32 x 12 cm 30 Print Code: F(1)





APP
COMPATIBLE WITH
ANDROID & iOS



New



Picty 21017

Digital Photo Frame, 10,1", Wifi, 1280x800 IPS, AC 220-240V.
 Digitaler Photoramen, 10,1", Wifi, 1280x800 IPS, AC 220-240V.
 Cadre Photos Digitales, 10,1", Wifi, 1280x800 IPS, AC 220-240V.
 Digitale Fotolijst, 10,1", Wifi, 1280x800 IPS, AC 220-240V.

26.4 x 18.4 x 2.2 cm 10 Print Code: G(1)

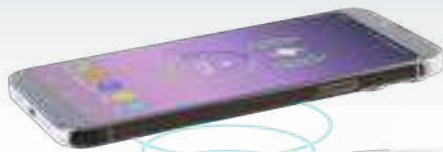

Thumal 1996



Multifunction Alarm Clock. Wireless 10W. USB Connection.
 Multifunktion Tischuhr. Drahtlos 10W. Anschluss USB.
 Horloge Multifonction. Sans Fil 10W. Connexion USB.
 Multifunctioneel Klok. Draadloos 10W. USB Connectie.

11.3 x 3 x 11.2 cm 30 Print Code: E(4)



Fabirt 1148

Multifunction Alarm Clock. Lamp 36 Leds. Adjustable Brightness. Wireless Charger 10W. USB Connection.
 Multifunktion Tischuhr. Lampe 36 Leds. Einstellbare Lichtintensität. Drahtlos Ladegerät 10W. USB Anschluss.
 Horloge Multifonction. Lampe 36 Leds. Lumière à Intensité Réglable. Chargeur Sans Fil 10W. Connexion Bluetooth.
 Multifunctioneel Klok. Lamp 36 Leds. Lamp met Instelbare Lichtintensiteit. Draadloos Oplader 10W. USB Verbinding.

15.4 x 5.1 x 8.6 cm 30 Print Code: E(4)



Eciko 20240

Desk Clock. Bamboo/ Stainless Steel. 1 Battery AA Not Included.
Tischuhr. Bambus/ Rostfreier Stahl. 1 AA Batterie Nicht im Lieferumfang.
Horloge. Bambou/ Acier Inox. 1 Pile AA Non Inclusive.
Klok. Bamboe/ Roestvrij Staal. 1 Batterij AA Niet Inclusief.

8.5 x 10.1 x 5.3 cm 50 Print Code: E(4), L1

Graox 20241

Desk Clock. Bamboo. Water Powered.
Tischuhr. Bambus. Funktioniert mit Wasser.
Horloge. Bambou. Fonctionne à l'Eau.
Klok. Bamboe. Water Energie.

9.5 x 8 x 9 cm 40 Print Code: E(4), L1

Tulax 6517



Radio Alarm Clock. Bamboo. 2 Batteries AAA Not Included.
Radio Tischuhr. Bambus. 2 AAA Batterien Nicht im Lieferumfang.
Horloge Radio. Bambou. 2 Piles AAA Non Inclusive.
Radio Klok. Bamboe. 2 Batterijen AAA Niet Inclusief.

12.5 x 8.5 x 4.7 cm 50 / 25 Print Code: E(4), L2, W



Islum 1141



Multifunction Alarm Clock. Bamboo. Wireless Charger 5W. Adjustable Brightness. USB Connection.
Multifunktion Tischuhr. Bambus. Drahtlos Ladegerät 5W. Einstellbare Lichtintensität. USB Anschluss.
Horloge Multifonction. Bambou. Chargeur Sans Fil 5W. Lumière à Intensité Réglable. Connexion USB.
Multifunctioneel Klok. Bamboe. Draadloos Oplader 5W. Lamp met Instelbare Lichtintensiteit. USB Verbinding.

16 x 4 x 7.5 cm 40 Print Code: E(4), L2, W

Melbran 1142



Multifunction Alarm Clock. Bamboo. Adjustable Brightness. USB Connection. 3 Piles AAA Non Included.
Multifunktion Tischuhr. Bambus. Einstellbare Lichtintensität. USB Anschluss. 3 AAA Batterien Nicht im Lieferumfang.
Horloge Multifonction. Bambou. Lumière à Intensité Réglable. Connexion USB. 3 Piles AAA Non Inclusive.
Multifunctioneel Klok. Bamboe. Lamp met Instelbare Lichtintensiteit. USB Verbinding. 3 Batterijen AAA Niet Inclusief.

6.3 x 6.3 x 6.3 cm 50 / 25 Print Code: E(4), L2, W

BAMBOO Weather Station



Roamer 20875



Weather Station. Bamboo/ABS. 1 Battery AAA Not Included.
Wetterstation. Bambus/ABS. 1 AAA Batterie Nicht im Lieferumfang.
Station Météo. Bamboo/ABS. 1 Pile AAA Non Inclusive.
Weerstation. Bamboe/ABS. 1 Batterij AAA Niet Inclusief.

13.3 x 7.3 x 3.1 cm 80 / 20 Print Code: E(4), L2, W



Behox 6806

Weather Station. Bamboo/ABS. 2 Batteries AAA Not Included.
Wetterstation. Bambus/ABS. 2 AAA Batterien Nicht im Lieferumfang.
Station Météo. Bamboo/ABS. 2 Piles AAA Non Inclusive.
Weerstation. Bamboe/ABS. 2 Batterijen AAA Niet Inclusief.



13 x 13 x 2.4 cm 50 / 25 Print Code: E(4), L2, W



Krent 1233



Photo Frame Weather Station. Bamboo. Photos Size: 9 x 14 cm. Button Batteries Included.
Wetterstation Bilderrahmen. Bambus. Photos: 9 x 14 cm. Knopfzellen Inklusive.
Station Météo Porte Photos. Bamboo. Photos: 9 x 14 cm. Piles Bouton Inclusive.
Fotolijst Weerstation. Bamboe. Foto's Maat: 9 x 14 cm. Knooppcel Batterijen Inclusief.

21 x 18 x 1.5 cm 30 Print Code: E(4), L2



Fiory 1201



Weather Station Charger. Bamboo. Wireless 10W. Button Battery Included.
Ladegerät Wetterstation. Bambus. Drahtlos 10W. Knopfzelle Inklusive.
Station Météo Chargeur. Bamboo. Sans Fil 10W. Pile Bouton Inclusive.
Oplader Weerstation. Bamboe. Draadloos 10W. Knooppcel Batterij Inclusief.

18 x 17 x 2.3 cm 40 / 20 Print Code: E(4), L2

Every Action Counts

Small, Everyday Actions for Energy Saving and Efficiency



Helein 6516

Weather Station. Bamboo/ ABS. 2 Batteries AAA Not Included.
Wetterstation. Bambus/ ABS. 2 AAA Batterien Nicht im Lieferumfang.
Station Météo. Bambou/ ABS. 2 Piles AAA Non Incluses.
Weerstation. Bamboe/ ABS. 2 Batterijen AAA Niet Inclusief.

8.5 x 12 x 6 cm 50 / 25 Print Code: E(4), L1, W



Yenen 1961



Weather Station. Bamboo. Button Battery Included.
Wetterstation. Bambus. Knopfzelle Inklusive.
Station Météo. Bambou. Pile Bouton Incluse.
Weerstation. Bamboe. Knoopecel Batterij Inclusief.

9 x 12 x 2.3 cm 100 / 50 Print Code: D(4), L1



Vorad 1962

Timer. Button Battery Included.
Timer. Knopfzelle Inklusive.
Minuteur. Pile Bouton Incluse.
Eierwekker. Knoopecel Batterij Inclusief.

5.6 x 7.3 x 2.3 cm 200 / 50 Print Code: D(4)



Tynna 1963



Weather Station. Magnetic. Button Battery Included.
Wetterstation. Magnetisch. Knopfzelle Inklusive.
Station Météo. Magnétique. Pile Bouton Incluse.
Weerstation. Magnetisch. Knoopecel Batterij Inclusief.

4.6 x 4.5 x 1.6 cm 300 / 50 Print Code: D(4)



Geibol 21021

Weather Station. 2 Batteries AAA Not Included.
 Wetterstation. 2 AAA Batterien Nicht im Lieferumfang.
 Station Météo. 2 Piles AAA Non Incluses.
 Weerstation. 2 Batterijen AAA Niet Inclusief.

6.7 x 14.3 x 5.5 cm 50 / 25 Print Code: E(4)

WHEAT
STRAW



Maginly 21022

Weather Station. Wheat Straw/ ABS. 2 Batteries AAA Not Included.
 Wetterstation. Weizenstroh/ ABS. 2 AAA Batterien Nicht im Lieferumfang.
 Station Météo. Paille de Blé/ ABS. 2 Piles AAA Non Incluses.
 Weerstation. Tarwestro/ ABS. 2 Batterijen AAA Niet Inclusief.

8 x 14.2 x 4 cm 50 / 25 Print Code: E(4)

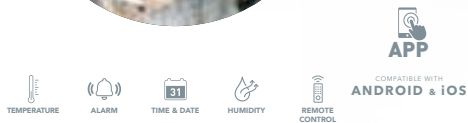

Lautar 1964

Weather Station. Indoor/ Outdoor Temperature Sensor. USB Connection Adapter.
 Wetterstation. Äußere und Innentemperatur Sensor. USB Anschluss Adapter.
 Station Météo. Température Intérieure/ Extérieure. Adaptateur Connexion USB.
 Weerstation. Binnen Buiten Temperatuur Sensor. USB Verbinding Adapter.

18.1 x 11.9 x 2 cm 20 / 10 Print Code: E(1), W





01 19 03



02



Selkos 1205

Smart Bracelet. TPU Strap. Bluetooth Connection. 0,96" TFT Screen. Battery 90 mAh.
 Intelligente Armband. TPU Armband. Bluetooth Anschluss. 0,96" TFT Screen. Batterie 90 mAh.
 Bracelet Intelligent. Bracelet TPU. Connexion Bluetooth. Écran TFT 0,96". Batterie 90 mAh.
 Smart Armband. TPU Band. Bluetooth Verbindung. 0,96" TFT Scherm. Batterij 90 mAh.

25.5 x 2.2 x 1.1 cm 100 / 50 Print Code: l(1), L2

- WEATHER
- HEART RATE MONITOR
- BLOOD PRESSURE
- O₂ BLOOD OXYGEN MONITOR
- CALORIES COUNTER
- MULTI SPORTS
- SLEEP MONITORING
- APP NOTIFY
- MESSAGE NOTIFY
- CALLS NOTIFY
- REMOTE SHUTTER
- ALARM
- VIBRATION
- TIME & DATE
- ANTI-LOST
- MUSIC PLAYER

Droy 6651

Smart Bracelet. TPU Strap. Bluetooth Connection. 0,96" TFT Screen. Battery 90 mAh.
 Intelligente Armband. TPU Armband. Bluetooth Anschluss. 0,96" TFT Screen. Batterie 90 mAh.
 Bracelet Intelligent. Bracelet TPU. Connexion Bluetooth. Écran TFT 0,96". Batterie 90 mAh.
 Smart Armband. TPU Band. Bluetooth Verbindung. 0,96" TFT Scherm. Batterij 90 mAh.

25.5 x 2.2 x 1.1 cm 100 / 50 Print Code: l(1), L2

- BODY TEMPERATURE
- HEART RATE MONITOR
- BLOOD PRESSURE
- O₂ BLOOD OXYGEN MONITOR
- CALORIES COUNTER
- MULTI SPORTS
- SLEEP MONITORING
- APP NOTIFY
- MESSAGE NOTIFY
- CALLS NOTIFY
- REMOTE SHUTTER
- ALARM
- VIBRATION
- TIME & DATE
- ANTI-LOST



03 19
04 05 01



02

Drogon 5313

Watch. Silicone Strap. Button Battery Included.
 Uhr. Silikonarmband. Knopfzelle inklusive.
 Montre. Bracelet Silicone. Pile Bouton Inclusive.
 Horloge. Siliconen Band. Knooppel Batterij Inclusief.

25 x 2.8 x 1.5 cm 100 / 50 Print Code: F(1)

- CALORIES COUNTER
- PEDOMETER
- KM DISTANCE COVERED
- TIME





- WEATHER
- HEART RATE MONITOR
- BLOOD PRESSURE
- BLOOD OXYGEN MONITOR
- CALORIES COUNTER
- TACTILE WATCH
- MULTI SPORTS
- SLEEP MONITORING
- STOPWATCH
- HANDS-FREE
- APP NOTIFY
- MESSAGE NOTIFY
- REMOTE SHUTTER
- ALARM
- VIBRATION
- TIME & DATE
- ANTI-LOST
- TORCH
- MUSIC PLAYER
- PHONE BOOK

APP
COMPATIBLE WITH
ANDROID & iOS

Connor 20272

Smart Watch. Silicone Strap. Bluetooth Connection. 1,83" TFT Screen. Wireless Rechargeable. Battery 180 mAh. Intelligente Uhr. Silikonarmband. Bluetooth Anschluss. 1,83" TFT Screen. Drahtlos Wiederaufladbar. Batterie 180 mAh. Montre Intelligente. Bracelet Silicone. Connexion Bluetooth. Ecran TFT 1,83". Rechargeable Sans Fil. Batterie 180 mAh. Smartwatch. Siliconen Band. Bluetooth Verbinding. 1,83" TFT Scherm. Draadloos Oplaadbaar. Batterij 180 mAh.

27 x 4 x 1,3 cm 50 Print Code: L2

- HEART RATE MONITOR
- BLOOD PRESSURE
- BLOOD OXYGEN MONITOR
- CALORIES COUNTER
- MULTI SPORTS
- SLEEP MONITORING
- APP NOTIFY
- MESSAGE NOTIFY
- CALLS NOTIFY
- REMOTE SHUTTER
- ALARM
- VIBRATION
- TIME & DATE
- ANTI-LOST

APP
COMPATIBLE WITH
ANDROID & iOS



06

Simont 6747

Smart Watch. TPU Strap. Bluetooth Connection. 1,44" LCD Screen. Battery 50 mAh. Intelligente Uhr. TPU Armband. Bluetooth Anschluss. 1,44" LCD Screen. Batterie 50 mAh. Montre Intelligente. Bracelet TPU. Connexion Bluetooth. Ecran LCD 1,44". Batterie 50 mAh. Smartwatch. TPU Band. Bluetooth Verbinding. 1,44" LCD Scherm. Batterij 50 mAh.

25 x 3,6 x 1,3 cm 50 Print Code: I(1), L2



01 02

NEW COLOR



19 03

- HEART RATE MONITOR
- BLOOD PRESSURE
- BLOOD OXYGEN MONITOR
- CALORIES COUNTER
- TACTILE WATCH
- MULTI SPORTS
- SLEEP MONITORING
- STOPWATCH
- HANDS-FREE
- APP NOTIFY
- MESSAGE NOTIFY
- REMOTE SHUTTER
- ALARM
- VIBRATION
- TIME & DATE
- ANTI-LOST
- TORCH
- MUSIC PLAYER
- PHONE BOOK

APP
COMPATIBLE WITH
ANDROID & iOS

Proxor 6746

METAL CASING

Smart Watch. TPU Strap. Bluetooth Connection. 1,54" IPS Screen. Battery 160 mAh. Intelligente Uhr. TPU Armband. Bluetooth Anschluss. 1,54" IPS Screen. Batterie 160 mAh. Montre Intelligente. Bracelet TPU. Connexion Bluetooth. Ecran IPS 1,54". Batterie 160 mAh. Smartwatch. TPU Band. Bluetooth Verbinding. 1,54" TFT Scherm. Batterij 160 mAh.

27 x 4 x 1,3 cm 50 Print Code: I(1), L2

- WEATHER
- HEART RATE MONITOR
- BLOOD PRESSURE
- BLOOD OXYGEN MONITOR
- CALORIES COUNTER
- MULTI SPORTS
- SLEEP MONITORING
- APP NOTIFY
- MESSAGE NOTIFY
- CALLS NOTIFY
- REMOTE SHUTTER
- ALARM
- VIBRATION
- TIME & DATE
- ANTI-LOST
- MUSIC PLAYER

APP
COMPATIBLE WITH
ANDROID & iOS

Krirt 1995

Smart Watch. TPU Strap. Bluetooth Connection. 1,3" TFT Screen. Battery 180 mAh. Intelligente Uhr. TPU Armband. Bluetooth Anschluss. 1,3" TFT Screen. Batterie 180 mAh. Montre Intelligente. Bracelet TPU. Connexion Bluetooth. Ecran TFT 1,3". Batterie 180 mAh. Smartwatch. TPU Band. Bluetooth Verbinding. 1,3" TFT Scherm. Batterij 180 mAh.

26 x 4,7 x 1,4 cm 50 Print Code: I(1), L2



LIMITED **edition**
EXPERIENCE

- WEATHER
- HEART RATE MONITOR
- BLOOD PRESSURE
- BLOOD OXYGEN MONITOR
- CALORIES COUNTER
- TACTILE WATCH
- MULTI SPORTS
- SLEEP MONITORING
- STOPWATCH
- HANDS-FREE
- APP NOTIFY
- MESSAGE NOTIFY
- REMOTE SHUTTER
- ALARM
- VIBRATION
- TIME & DATE
- ANTI-LOST
- MUSIC PLAYER
- PHONE BOOK
- APP COMPATIBLE WITH ANDROID & iOS



Hendor 1359

Smart Watch. TPU Strap. Bluetooth Connection. 1,28" TFT Screen. Battery 230 mAh.
Intelligente Uhr. TPU Armband. Bluetooth Anschluss. 1,28" TFT Screen. Batterie 230 mAh.
Montre Intelligente. Bracelet TPU. Connexion Bluetooth. Écran TFT 1,28". Batterie 230 mAh.
Smartwatch. TPU Band. Bluetooth Verbindung. 1,28" TFT Scherm. Batterij 230 mAh.

26 x 4.5 x 1 cm 50 Print Code: F(1), J(1), L2



LIMITED **edition**
EXPERIENCE

- WEATHER
- HEART RATE MONITOR
- BLOOD PRESSURE
- BLOOD OXYGEN MONITOR
- CALORIES COUNTER
- TACTILE WATCH
- MULTI SPORTS
- SLEEP MONITORING
- STOPWATCH
- HANDS-FREE
- APP NOTIFY
- MESSAGE NOTIFY
- REMOTE SHUTTER
- ALARM
- VIBRATION
- TIME & DATE
- ANTI-LOST
- TORCH
- MUSIC PLAYER
- PHONE BOOK
- APP COMPATIBLE WITH ANDROID & iOS



Munrok 1360

Smart Watch. TPU Strap. Bluetooth Connection. 1,69" TFT Screen. Battery 180 mAh.
Intelligente Uhr. TPU Armband. Bluetooth Anschluss. 1,69" TFT Screen. Batterie 180 mAh.
Montre Intelligente. Bracelet TPU. Connexion Bluetooth. Écran TFT 1,69". Batterie 180 mAh.
Smartwatch. TPU Band. Bluetooth Verbindung. 1,69" TFT Scherm. Batterij 180 mAh.

26 x 4.5 x 1 cm 50 Print Code: F(1), J(1), L2



- WEATHER
- HEART RATE MONITOR
- BLOOD PRESSURE
- BLOOD OXYGEN MONITOR
- TACTILE WATCH
- MULTI SPORTS
- SLEEP MONITORING
- STOPWATCH
- HANDS-FREE
- APP NOTIFY
- MESSAGE NOTIFY
- REMOTE SHUTTER
- ALARM
- VIBRATION
- TIME & DATE
- ANTI-LOST
- TORCH
- MUSIC PLAYER
- APP COMPATIBLE WITH ANDROID & iOS



METAL CASING

Pinsir 1436

Smart Watch. TPU Strap. Bluetooth Connection. 1,3" TFT Screen. Earphones Included. Battery 35 mAh/ Charging Station 300 mAh.
Intelligente Uhr. TPU Armband. Bluetooth Anschluss. 1,3" TFT Screen. Kopfhörer Inklusiv. Batterie 35 mAh/ Aufladestation 300 mAh.
Montre Intelligente. Bracelet TPU. Connexion Bluetooth. Écran TFT 1,3". Écouteurs Incluses. Batterie 35 mAh/ Poste de Charge 300 mAh.
Smartwatch. TPU Band. Bluetooth Verbindung. 1,3" TFT Scherm. Oordopjes Inclusief. Batterij 35 mAh/ Opladstation 300 mAh.

27 x 4 x 3 cm 50 Print Code: I(1), L2



- HEART RATE MONITOR
- CALORIES COUNTER
- MULTI SPORTS
- SLEEP MONITORING
- HANDS-FREE
- ALARM
- VIBRATION
- TIME & DATE



Rusk 6226

Smart Bracelet. TPU Strap. Bluetooth Connection. 0,96" LCD Screen. Battery 80 mAh.
Intelligente Uhr. TPU Armband. Bluetooth Anschluss. 0,96" LCD Screen. Batterie 80 mAh.
Bracelet Intelligent. Bracelet TPU. Connexion Bluetooth. Écran LCD 0,96". Batterie 80 mAh.
Smart Armband. TPU Band. Bluetooth Verbindung. 0,96" LCD Scherm. Batterij 80 mAh.

24.5 x 2.4 x 1.9 cm 100/50 Print Code: I(1), L2

APP COMPATIBLE WITH ANDROID & iOS



BLUETOOTH CALLS
MAKE AND RECEIVE CALLS WITHOUT A SIM CARD

APP
COMPATIBLE WITH
ANDROID & iOS

- WEATHER
- HEART RATE MONITOR
- BLOOD PRESSURE
- O₂ BLOOD OXYGEN MONITOR
- CALORIES COUNTER
- TACTILE WATCH
- MULTI SPORTS
- SLEEP MONITORING
- STOPWATCH
- HANDS-FREE
- APP NOTIFY
- MESSAGE NOTIFY
- REMOTE SHUTTER
- ALARM
- VIBRATION
- TIME & DATE
- ANTI-LOST
- MUSIC PLAYER
- PHONE BOOK

Fronk 1344

Smart Watch. Leather Strap. Bluetooth Connection. 1,32" TFT Screen. Battery 230 mAh.
Intelligente Uhr. Leder Armband. Bluetooth Anschluss. 1,32" TFT Screen. Batterie 230 mAh.
Montre Intelligente. Bracelet Cuir. Connexion Bluetooth. Écran TFT 1,32". Batterie 230 mAh.
Smartwatch. Leer Band. Bluetooth Verbindung. 1,32" TFT Scherm. Batterij 230 mAh.

26.5 x 4.8 x 1.2 cm 50 Print Code: (f), L2



APP
COMPATIBLE WITH
ANDROID & iOS

- WEATHER
- HEART RATE MONITOR
- BLOOD PRESSURE
- O₂ BLOOD OXYGEN MONITOR
- CALORIES COUNTER
- TACTILE WATCH
- MULTI SPORTS
- SLEEP MONITORING
- STOPWATCH
- HANDS-FREE
- APP NOTIFY
- MESSAGE NOTIFY
- REMOTE SHUTTER
- ALARM
- VIBRATION
- TIME & DATE
- ANTI-LOST
- MUSIC PLAYER
- PHONE BOOK

Dant 1345

Smart Watch. Stainless Steel Strap. Bluetooth Connection. 1,32" TFT Screen. Battery 230 mAh.
Intelligente Uhr. Metall Rostfreier Stahl. Bluetooth Anschluss. 1,32" TFT Screen. Batterie 230 mAh.
Montre Intelligente. Bracelet Acier Inox. Connexion Bluetooth. Écran TFT 1,32". Batterie 230 mAh.
Smartwatch. Roestvrij Staal Band. Bluetooth Verbinding. 1,32" TFT Scherm. Batterij 230 mAh.

15 x 4.8 x 1.2 cm 50 Print Code: L2



ANTONIO MIRO

Antonio Miró is currently a benchmark in the increasingly demanding fashion industry. Worldwide renowned and consolidated in showcases such as Paris, Milan, New York and Tokyo, with prestige earned by collections based on simplicity and perfection, being these his personal hallmarks. Minimalist like few others, Antonio Miró devotes his success to elegance, an objective he has never renounced.

- WEATHER
- HEART RATE MONITOR
- BLOOD PRESSURE
- O₂ BLOOD OXYGEN MONITOR
- CALORIES COUNTER
- TACTILE WATCH
- MULTI SPORTS
- SLEEP MONITORING
- STOPWATCH
- HANDS-FREE
- APP NOTIFY
- MESSAGE NOTIFY
- REMOTE SHUTTER
- ALARM
- VIBRATION
- TIME & DATE
- ANTI-LOST
- TORCH
- MUSIC PLAYER
- PHONE BOOK



Daford 7369

Smart Watch. Leather Strap. Bluetooth Connection. 1,32" TFT Screen. Multilingual. Battery 300 mAh.
Intelligente Uhr. Leder Armband. Bluetooth Anschluss. 1,32" TFT Screen. In Mehreren Sprachen. Batterie 300 mAh.
Montre Intelligente. Bracelet Cuir. Connexion Bluetooth. Écran TFT 1,32". Multilingue. Batterie 300 mAh.
Smartwatch. Leer Band. Bluetooth Verbinding. 1,32" TFT Scherm. Meertalig. Batterij 300 mAh.

26.5 x 4.6 x 1.2 cm 50 Print Code: (f), L2



BLUETOOTH CALLS
MAKE AND RECEIVE CALLS WITHOUT A SIM CARD



Security



New



New



WI-FI SUPPORT



WI-FI SUPPORT

OUTDOOR

INDOOR

- 1080P**
FULL HD
- PHOTO CAMERA
- VIDEO RECORDING
- DAY & NIGHT VISION
- MOTION DETECTION
- REMOTE CONTROL & VIEWING
- PUSH NOTIFICATIONS
- REMOTE TALKBACK
- SIMPLE SETUP
- MICRO SD

- 1080P**
FULL HD
- PHOTO CAMERA
- VIDEO RECORDING
- DAY & NIGHT VISION
- MOTION DETECTION
- REMOTE CONTROL & VIEWING
- PUSH NOTIFICATIONS
- REMOTE TALKBACK
- SIMPLE SETUP
- MICRO SD

Grotex 21014

Smart Camera. Wifi. AC 220-240V.
 Smart Kamera. Wifi. AC 220-240V.
 Vidéosurveillance Intelligente. Wifi. AC 220-240V.
 Smart Camara. Wifi. AC 220-240V.

8.6 x 13 x 11.2 cm 20 Print Code: J(1)



Deors 21013

Smart Camera. Wifi. AC 220-240V.
 Smart Kamera. Wifi. AC 220-240V.
 Vidéosurveillance Intelligente. Wifi. AC 220-240V.
 Smart Camara. Wifi. AC 220-240V.

Ø 8.1 x 11.2 cm 40 / 20 Print Code: J(1)





- HD**
HIGH DEFINITION
- PHOTO CAMERA**
- VIDEO RECORDING**
- REMOTE CONTROL & VIEWING**
- AUTO HOVER**

Acrot 21019

Drone. Wifi. Batterie 600 mAh. Remote Control 3 Batteries AA Not Included.

Drohne. Wifi. Batterie 600 mAh. Fernbedienung 3 AA Batterien Nicht im Lieferumfang.

Drone. Wifi. Batterie 600 mAh. Contrôle à Distance 3 Piles AA Non Incluses.

Drohne. Wifi. Batterij 600 mAh. Afstandsbediening 3 Batterijen AA Niet Inclusief.



24 x 18 x 6 cm 20 Print Code: J(8)

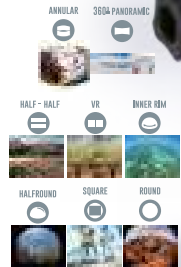

WATERPROOF **MICRO SD**

Logans 5529

Action Camera 360°. 2448P. Wifi. 0,96" LCD Screen. 10 Accessories. Multilingual. Battery 1100 mAh.
Sportkamera 360°. 2448P. Wifi. 0,96" LCD Screen. 10 Teile. In Mehreren Sprachen. Batterie 1100 mAh.
Caméra Sportive 360°. 2448P. Wifi. Écran LCD 0,96". 10 Accessoires. Multilingue. Batterie 1100 mAh.
Sport Camera 360°. 2448P. Wifi. 0,96" LCD Scherm. 10 Accessoires. Meertalig. Batterij 1100 mAh.

13 x 13 x 11 cm 18 Print Code: K(1)



WATERPROOF **MICRO SD**

Garrix 5528

Action Camera. 4K. Wifi. 2" LCD Screen. 16 Accessories. Multilingual. Battery 900 mAh.
Sportkamera. 4K. Wifi. 2" LCD Screen. 16 Teile. In Mehreren Sprachen. Batterie 900 mAh.
Caméra Sportive. 4K. Wifi. Écran LCD 2". 16 Accessoires. Multilingue. Batterie 900 mAh.
Sport Camera. 4K. Wifi. 2" LCD Scherm. 16 Accessoires. Meertalig. Batterij 900 mAh.

16 x 23 x 6 cm 20 Print Code: K(4)



WATERPROOF **MICRO SD**

Komir 5246

Action Camera. 720P. 2" LCD Screen. 14 Accessories. Multilingual. Battery 900 mAh.
Sportkamera. 720P. 2" LCD Screen. 14 Teile. In Mehreren Sprachen. Batterie 900 mAh.
Caméra Sportive. 720P. Écran LCD 2". 14 Accessoires. Multilingue. Batterie 900 mAh.
Sport Camera. 720P. 2" LCD Scherm. 14 Accessoires. Meertalig. Batterij 900 mAh.

12 x 23 x 5,8 cm 20 Print Code: K(4)



HDMI & WIFI

New



Heroux 21225



MICRO SD



USB PLAYER

Projector. 720P. Wifi. Bluetooth Connection. Sound Power 5W. 7000 Lumens. AC 220-240V.
 Projektor. 720P. Wifi. Bluetooth Anschluss. Schalleistung 5W. 7000 Lumen. AC 220-240V.
 Projecteur. 720P. Wifi. Connexion Bluetooth. Puissance Sonore 5W. 7000 Lumens. AC 220-240V.
 Projector. 720P. Wifi. Bluetooth Verbinding. Geluidsvermogen 5W. 7000 Lumens. AC 220-240V.

22.1 x 8.6 x 16.8 cm 4 Print Code: K(1)



New

WHEAT
STRAW

Lesi 20878

Presenter Laser Pointer. Wheat Straw/ ABS. Wireless. USB Connection. 1 Battery AAA/ R03 Included.
 Präsentator Laser Pointer. Weizenstroh/ ABS. Optisch. USB Anschluss. 1 AAA/ R03 Batterie Inklusive.
 Pointeur Laser Présentateur. Paille de Blé/ ABS. Optique. Connexion USB. 1 Pile AAA/ R03 Incluse.
 Presenter Laser Pointer. Tarvestro/ ABS. Optical. USB Verbinding. 1 Batterij AAA/ R03 Inclusief.

2.5 x 1.4 x 14 cm 50 Print Code: C(4)

Haslam 5202

Presenter Laser Pointer. Wireless. USB Connection. 1 Battery AAA/ R03 Included.
 Präsentator Laser Pointer. Optisch. USB Anschluss. 1 AAA/ R03 Batterie Inklusive.
 Pointeur Laser Présentateur. Optique. Connexion USB. 1 Pile AAA/ R03 Incluse.
 Presenter Laser Pointer. Optical. USB Verbinding. 1 Batterij AAA/ R03 Inclusief.

1.7 x 13.9 x 1.5 cm 50 Print Code: D(4), W

Decolf 1952

Presenter Laser Pointer. Wireless. USB Connection. 2 Battery AAA/ R03 Included.
 Präsentator Laser Pointer. Optisch. USB Anschluss. 2 AAA/ R03 Batterien Inklusive.
 Pointeur Laser Présentateur. Optique. Connexion USB. 2 Piles AAA/ R03 Incluses.
 Presenter Laser Pointer. Optical. USB Verbinding. 2 Batterijen AAA/ R03 Inclusief.

3.2 x 12.2 x 2.4 cm 100 / 25 Print Code: D(4)



Rpet & Bamboo



New

Craig 20246

Multifunction Mousepad. Polyester 300D RPET/ Velvet/ Bamboe. 1 Hub Type C. 4 Hubs USB 2.0. Anti-Slip.
 Multifunktion Mauspad. Polyester 300D RPET/ Wildleder/ Bambus. 1 Typ C Hub. 4 Hubs USB 2.0. Rutschfest.
 Tapis Souris Multifonction. Polyester 300D RPET/ Suédine/ Bamboe. 1 Port Type C. 4 Ports USB 2.0. Antidérapant.
 Multifunctioneel Muispad. Polyester 300D RPET/ Fluweel/ Bamboe. 1 Type C Poort. 4 Poorten USB 2.0. Anti-Slip.

22 x 24 cm 40 Print Code: E(4), L1, N(8)



New

Hossian 20247

(15W)
WIRELESS CHARGER

Multifunction Mousepad. Polyester 300D RPET/ Velvet/ Bamboe. Foldable. Wireless Charger 15W. Anti-Slip.
 Multifunktion Mauspad. Polyester 300D RPET/ Wildleder/ Bambus. Faltbar. Drahtlos Ladegerät 15W. Rutschfest.
 Tapis Souris Multifonction. Polyester 300D RPET/ Suédine/ Bamboe. Pliable. Chargeur Sans Fil 15W. Antidérapant.
 Multifunctioneel Muispad. Polyester 300D RPET/ Fluweel/ Bamboe. Opvouwbaar. Draadloos Oplader 15W. Anti-Slip.

20.5 x 26 cm 40 Print Code: E(4), L1, N(8)



(15W)
WIRELESS CHARGER

Deuz 20860

Charger Mousepad. Polyester 300D RPET. Wireless 15W. Anti-Slip.
 Ladegerät Mauspad. Polyester 300D RPET. Drahtlos 15W. Rutschfest.
 Tapis Souris Chargeur. Polyester 300D RPET. Sans Fil 15W. Antidérapant.
 Oplader Muispad. Polyester 300D RPET. Draadloos 15W. Anti-Slip.

31 x 27 cm 20 Print Code: E(4), N(8)

Rpet



Bistol 1366

Charger Mousepad. Bamboo. Wireless 10W. Anti-Slip.
 Ladegerät Mauspad. Bambus. Drahtlos 10W. Rutschfest.
 Tapis Souris Chargeur. Bamboo. Sans Fil 10W. Antidérapant.
 Oplader Muispad. Bamboe. Draadloos 10W. Anti-Slip.

Ø21 x 0.8 cm 50 Print Code: F(1), L2

Bamboo

THE MOST

TRANSPARENT TECH



New

((15W))
WIRELESS CHARGER

Gaussian 21194

Charger: Bamboo. Wireless 15W.
Ladegerät: Bambus. Drahtlos 15W.
Chargeur: Bambou. Sans Fil 15W.
Oplader: Bamboe. Draadloos 15W.

9 x 0.9 x 9 cm 100 / 25 Print Code: E(4), W



New

((15W))
WIRELESS CHARGER

Layerit 21193

Charger: Bamboo. Wireless 15W.
Ladegerät: Bambus. Drahtlos 15W.
Chargeur: Bambou. Sans Fil 15W.
Oplader: Bamboe. Draadloos 15W.

16.3 x 1 x 7.5 cm 100 / 25 Print Code: E(4), W

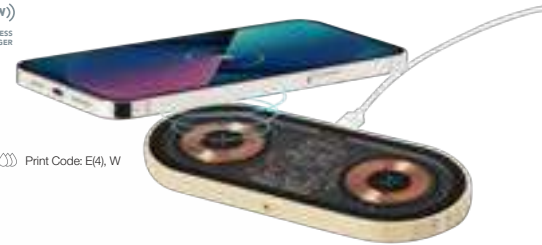

New

5000
mAh

Dominik 21192

PD POWER DELIVERY ((15W)) WIRELESS CHARGER

Power Bank. Bamboo. Wireless 15W. Magnetic. 5000 mAh. Type C Output and Input.
Power Bank. Bambus. Drahtlos 15W. Magnetisch. 5000 mAh. Typ C Ausgänge und Eingang.
Power Bank. Bambou. Sans Fil 15W. Magnétique. 5000 mAh. Sortie et Entrée Type C.
Power Bank. Bamboe. Draadloos 15W. Magnetisch. 5000 mAh. Typ C Output en Input.

6.5 x 10 x 1.9 cm 50 / 10 Print Code: E(4), W



ADHESIVE ACCESSORY INCLUDED



New

COMPATIBLE WITH
MAGSAFE & Qi
TECHNOLOGY

Ming 21191

((15W))
WIRELESS CHARGER

Charger: Bamboo. Wireless 15W. Magnetic.
Ladegerät: Bambus. Drahtlos 15W. Magnetisch.
Chargeur: Bambou. Sans Fil 15W. Magnétique.
Oplader: Bamboe. Draadloos 15W. Magnetisch.

Ø 6.6 x 0.7 cm 200 / 100 Print Code: E(4)



ADHESIVE ACCESSORY INCLUDED

TRANSPARENT TECH



ADHESIVE ACCESSORY INCLUDED



New

5000 mAh

PD POWER DELIVERY ((15W)) WIRELESS CHARGER

Bramson 20251

Power Bank, Wireless 15W, Magnetic, 5000 mAh, 2 USB Outputs, Type C Output and Input.
 Power Bank, Drahtlos 15W, Magnetisch, 5000 mAh, 2 USB Ausgänge, Typ C Ausgänge und Eingang.
 Power Bank, Sans Fil 15W, Magnétique, 5000 mAh, 2 Sorties USB, Sortie et Entrée Type C.
 Power Bank, Draadloos 15W, Magnetisch, 5000 mAh, 2 USB Outputs, Typ C Output en Input.
 6.9 x 10.9 x 1.9 cm 40 / 10 Print Code: E(4), W

COMPATIBLE WITH MAGSAFE & Qi TECHNOLOGY



New

Andrew 20250

Charger, Wireless 15W, Magnetic, Ladegerät, Drahtlos 15W, Magnetisch, Chargeur, Sans Fil 15W, Magnétique, Oplader, Draadloos 15W, Magnetisch.

((15W)) WIRELESS CHARGER

COMPATIBLE WITH MAGSAFE & Qi TECHNOLOGY

Ø 5.6 x 0.6 cm 200 / 100 Print Code: E(4)



ADHESIVE ACCESSORY INCLUDED



New

Hevan 20252

IN/OUT TYPE C

USB Hub, 1 Hub Type C, 2 Hubs USB 2.0, USB Hub, 1 Typ C Hub, 2 Hubs USB 2.0, Port USB, 1 Port Type C, 2 Ports USB 2.0, USB Hub, 1 Type C Poort, 2 Poorten USB 2.0.

8 x 1.1 x 3.7 cm 200 / 50 Print Code: D(4)



New

Webex 20249

Earphones, Bluetooth Connection, Battery 30 mAh/ Charging Station 200 mAh, Kopfhörer, Bluetooth Anschluss, Batterie 30 mAh/ Aufladestation 200 mAh, Écouteurs, Connexion Bluetooth, Batterie 30 mAh/ Poste de Charge 200 mAh, Oordopjes, Bluetooth Verbinding, Batterij 30 mAh/ Oplaadstation 200 mAh.

5.2 x 2.5 x 4.4 cm 100 / 50 Print Code: E(1), W



New

Mirabek 21196

Mouse, Wireless, Optical, DPI Button, Battery 300 mAh, Maus, Drahtlos, Optisch, DPI Taste, Batterie 300 mAh, Souris, Sans Fil, Optique, Bouton DPI, Batterie 300 mAh, Muis, Draadloos, Optisch, DPI Knop, Batterij 300 mAh.

11.2 x 2.8 x 5.5 cm 100 / 25 Print Code: E(1), L1, W



((15W))
WIRELESS
CHARGER

Steward 20281

Charger. Bamboo. Led Lights. Wireless 15W.
Ladegerät. Bambus. Led Lichter. Drahtlos 15W.
Chargeur. Bambou. Lumières Led. Sans Fil 15W.
Oplader. Bamboe. Led Lichten. Draadloos 15W.

📏 6.5 x 11.5 x 8.5 cm 📦 50 / 25 🖨️ Print Code: E(1), L2



SPECIAL LASER ENGRAVING WHITE LIGHT LOGO

These items with illuminated interior have an external coating specially designed for laser engraving, with which you will see your advertising or brand illuminated with white light. Ideal for pad printing too.



Beckett 20282

((15W))
WIRELESS
CHARGER

Charger. Bamboo. Led Lights. Wireless 15W.
Ladegerät. Bambus. Led Lichter. Drahtlos 15W.
Chargeur. Bambou. Lumières Led. Sans Fil 15W.
Oplader. Bamboe. Led Lichten. Draadloos 15W.

📏 Ø 6.8 x 1.1 cm 📦 100 / 50 🖨️ Print Code: E(1), L2



5000
mAh

Koby 20283

Power Bank. Bamboo. Led Lights. 5000 mAh. USB Output. Type C Output and Input.
Power Bank. Bambus. Led Lichter. 5000 mAh. USB Ausgang. Typ C Ausgänge und Eingang.
Power Bank. Bambou. Lumières Led. 5000 mAh. Sortie USB. Sortie et Entrée Type C.
Power Bank. Bamboe. Led Lichten. 5000 mAh. USB Output. Typ C Output en Input.

📏 6.9 x 12.4 x 1.2 cm 📦 50 / 25 🖨️ Print Code: E(1), L2

SPECIAL LASER ENGRAVING WHITE LIGHT LOGO

These items with illuminated interior have an external coating specially designed for laser engraving, with which you will see your advertising or brand illuminated with white light. Ideal for pad printing too.



New

Olson 16GB 21210

USB Memory. Bamboo/ Aluminium. Led Lights.
USB Speicher. Bambus/ Aluminium. Led Lichter.
Clé USB. Bambou/ Aluminium. Lumières Led.
USB Memory. Bamboe/ Aluminium. Led Lichten.

1.5 x 6.5 x 0.6 cm 500 / 50 Print Code: D(1), L1, W

1

4

Ginger 20284



USB Hub. Bamboo. Led Lights. 1 Hub Type C. 2 Hubs USB 2.0.
USB Hub. Bambus. Led Lichter. 1 Typ C Hub. 2 Hubs USB 2.0.
Port USB. Bambou. Lumières Led. 1 Port Type C. 2 Ports USB 2.0.
USB Hub. Bamboe. Led Lichten. 1 Type C Poort. 2 Poorten USB 2.0.

9.7 x 1.5 x 4.4 cm 200 / 50 Print Code: D(1), L2

IN/OUT
TYPE C2=1
MICRO USB &
LIGHTNING

Lawrence 20285

Charging Cable. Bamboo. Led Lights. Micro USB, Type C and Lightning Connection 5V DC 2.4A.

Ladegerätkabel. Bambus. Led Lichter. Anschluss Micro USB, Typ C und Lightning 5V DC 2.4A.

Câble de Charge. Bambou. Lumières Led. Connexion Micro USB, Type C et Lightning 5V DC 2.4A.

Oplaadkabel. Bamboe. Led Lichten. Micro USB, Type C en Lightning Connectie 5V DC 2.4A.

4 x 17 x 1.3 cm 200 / 50 Print Code: D(1), L1



1

4

Afroks 16GB 20286

USB Memory. Bamboo. Led Lights.
USB Speicher. Bambus. Led Lichter.
Clé USB. Bambou. Lumières Led.
USB Memory. Bamboe. Led Lichten.

1.9 x 6.9 x 0.9 cm 500 / 50 Print Code: D(1), L1

SPECIAL LASER ENGRAVING WHITE LIGHT LOGO

4000
mAh2500
mAh

Kustol 6271

Power Bank. Led Lights. 4000 mAh. USB Output. Type C Output and Input.
Power Bank. Led Lichter. 4000 mAh. USB Ausgang. Typ C Ausgänge und Eingang.
Power Bank. Lumières Led. 4000 mAh. Sortie USB. Sortie et Entrée Type C.
Power Bank. Led Lichten. 4000 mAh. USB Output. Typ C Output en Input.

6.7 x 11.4 x 1 cm 100 / 50 Print Code: E(4), L2, W



Simmon 6149

Power Bank. Led Lights. 2500 mAh. USB Output. Micro USB Input.
Power Bank. Led Lichter. 2500 mAh. USB Ausgang. Micro USB Eingang.
Power Bank. Lumières Led. 2500 mAh. Sortie USB. Entrée Micro USB.
Power Bank. Led Lichten. 2500 mAh. USB Output. Micro USB Input.

6.2 x 12.3 x 0.9 cm 100 / 50 Print Code: E(4), L2, W



Keilmit 6142

Charger. Led Lights. Wireless 5W.
Ladegerät. Led Lichter. Drahtlos 5W.
Chargeur. Lumières Led. Sans Fil 5W.
Oplader. Led Lichten. Draadloos 5W.

15.5 x 1 x 6.1 cm 100 / 25
Print Code: E(4), L2, W



Brizem 6130

Charger. Led Lights. Wireless 10W.
Ladegerät. Led Lichter. Drahtlos 10W.
Chargeur. Lumières Led. Sans Fil 10W.
Oplader. Led Lichten. Draadloos 10W.

10 x 0.7 cm 100 / 50 Print Code: E(4), L2, W



SPECIAL LASER ENGRAVING WHITE LIGHT LOGO

Whoco 1950



Charging Cable. Led Lights. Micro USB, Type C and Lightning Connection 5V DC 2.4A.

Ladegerätakabel. Led Lichten. Anschluss Micro USB, Typ C und Lightning 5V DC 2.4A.

Câble de Charge. Lumières Led. Connexion Micro USB, Type C et Lightning 5V DC 2.4A.

Oplaadkabel. Led Lichten. Micro USB, Type C en Lightning Connectie 5V DC 2.4A.

2.9 x 17 x 0.9 cm 200 / 50

Print Code: D(1), L1



Lunem 6132

Speaker. Led Lights. Bluetooth Connection. Sound Power 3W. Battery 400 mAh.

Lautsprecher. Led Lichten. Bluetooth Anschluss. Schallleistung 3W. Batterie 400 mAh.

Haut-Parleur. Lumières Led. Connexion Bluetooth. Puissance Sonore 3W. Batterie 400 mAh.

Luidspreker. Led Lichten. Bluetooth Verbinding. Geluidsvermogen 3W. Batterij 400 mAh.

5.9 x 7.2 x 5.9 cm 50 Print Code: E(4), L2, W



Eddar 1951

(15W)
WIRELESS
CHARGER

Multifunction Pencil Holder. Led Lights. Wireless Charger 15W. 2 USB Outputs.

Multifunktion Stifthalter. Led Lichten. Drahtlos Ladegerät 15W. 2 USB Ausgänge.

Porte-Crayons Multifonction. Lumières Led. Chargeur Sans Fil 15W. 2 Sorties USB.

Multifunctioneel Pennenbakje. Led Lichten. Draadloos Oplader 15W. 2 USB Outputs.

8.8 x 11.3 x 10.5 cm 50 Print Code: E(4), L2

4000
mAh

64 Sheets
Lined



Weston 6184

Multifunction Notepad. Polyester 300D. Led Lights. Wireless Charger 5W. Power Bank 4000 mAh. 64 Sheets Notepad. USB Output. Micro USB Input.

Multifunktion Notizblock. Polyester 300D. Led Lichten. Drahtlos Ladegerät 5W. Power Bank 4000 mAh. 64 Blätter Notizblock. USB Ausgang. Micro USB Eingang.

Bloc Notes Multifonction. Polyester 300D. Lumières Led. Chargeur Sans Fil 5W. Power Bank 4000 mAh. Bloc 64 Feuilles. Sortie USB. Entrée Micro USB.

Multifunctioneel Notitieblokje. Polyester 300D. Led Lichten. Draadloos Oplader 5W. Power Bank 4000 mAh. 64 Blaadjes Notepad. USB Output. Micro USB Input.

18 x 22.5 x 2.5 cm 20 Print Code: G(1), N(8)

CHARGING STATION

TO CHARGE YOUR SMARTPHONE, EARPHONES AND SMARTWATCH



COMPATIBLE WITH
MAGSAFE & Qi
TECHNOLOGY

Gresin 20849

((15W))
WIRELESS
CHARGER

Charger. Wireless 15W. Magnetic. Charging Cable Set Included. Suitable for data transfer. Micro USB, Type C and Lightning Connection 5V DC 3A. SIM Card Ejector Included.

Ladegerät. Drahtlos 15W. Magnetisch. Ladegerätset Inklusive. Geeignet für die datenübertragung. Anschluss Micro USB, Typ C und Lightning 5V DC 3A. SIM-Karten-Auswurfwerkzeug Inklusiv.

Chargeur. Sans Fil 15W. Magnétique. Set Câbles du Chargeur Inclus. Convient au transfert de données. Connexion Micro USB, Type C et Lightning 5V DC 3A. Outil d'Éjection de Carte SIM Inclus.

Oplader. Draadloos 15W. Magnetisch. Opladkabel Set Inclusief. Geschikt voor data-overdracht. Micro USB, Type C en Lightning Connectie 5V DC 3A. SIM-Kaartuitwerper Inclusief.

📏 9 x 2.6 x 6.5 cm 📦 50 🖨️ Print Code: E(4), W

New



COMPATIBLE WITH
MAGSAFE & Qi
TECHNOLOGY

ADHESIVE
ACCESSORY
INCLUDED

Krastop 20264

((15W))
WIRELESS
CHARGER

Charger. Wireless 15W. Magnetic. Ladegerät. Drahtlos 15W. Magnetisch. Chargeur. Sans Fil 15W. Magnétique. Oplader. Draadloos 15W. Magnetisch.

📏 10.6 x 11.5 x 7.3 cm 📦 50 🖨️ Print Code: E(1)



ADHESIVE
ACCESSORY
INCLUDED



COMPATIBLE WITH
MAGSAFE & Qi
TECHNOLOGY

New

ADHESIVE
ACCESSORY
INCLUDED

Joyce 20265

((15W))
WIRELESS
CHARGER

Charger. Wireless 15W. Magnetic. Ladegerät. Drahtlos 15W. Magnetisch. Chargeur. Sans Fil 15W. Magnétique. Oplader. Draadloos 15W. Magnetisch.

📏 Ø 6.5 x 0.9 cm 📦 100 / 25 🖨️ Print Code: E(4)



5000
mAh

((15W))
WIRELESS
CHARGER

Barry 20266

Power Bank. Wireless 15W. 5000 mAh. USB Output. 2 Type C Output and Input. Power Bank. Drahtlos 15W. 5000 mAh. USB Ausgänge. 2 Typ C Ausgänge und Eingang. Power Bank. Sans Fil 15W. 5000 mAh. Sortie USB. 2 Sorties et Entrées Type C. Power Bank. Draadloos 15W. 5000 mAh. USB Output. 2 Typ C Output en Input.

📏 6.9 x 12.4 x 2.2 cm 📦 40 / 20 🖨️ Print Code: E(4), V, W

COMPATIBLE WITH
MAGSAFE & Qi
TECHNOLOGY

ADHESIVE
ACCESSORY
INCLUDED

CHARGING STATION

TO CHARGE YOUR SMARTPHONE, EARPHONES AND SMARTWATCH



Zibat 1434 ((15W))

WIRELESS CHARGER

Charger. Wireless 15W. USB Output. Foldable.
Ladegerät. Drahtlos 15W. USB Ausgang. Faltpbar.
Chargeur. Sans Fil 15W. Sortie USB. Pliable.
Oplader. Draadloos 15W. USB Output. Opvouwbaar.

10.9 x 15.3 x 12.2 cm 40
Print Code: E(1), W



Barichen 20876 ((15W))

WIRELESS CHARGER

Charger. Wheat Straw/ ABS/ Bamboe. Wireless 15W. Type C Output.
Ladegerät. Weizenstroh/ ABS/ Bambus. Drahtlos 15W. Typ C Ausgänge.
Chargeur. Paille de Blé/ ABS/ Bamboe. Sans Fil 15W. Sortie Type C.
Oplader. Tarwestro/ ABS/ Bamboe. Draadloos 15W. Typ C Output.

15 x 2.2 x 7 cm 50 / 25 Print Code: E(4), L2, W

LIMITED
edition
EXPERIENCE



Lonclow 1384

Organizer Charger. Bamboe/ ABS. Wireless 10W.
Ordner Ladegerät. Bambus/ ABS. Drahtlos 10W.
Chargeur Organiseur. Bamboe/ ABS. Sans Fil 10W.
Organizer Oplader. Bamboe/ ABS. Draadloos 10W.

22.4 x 9.6 x 7.7 cm 20 Print Code: F(1), L2



Hamsy 21186 ((15W))

WIRELESS CHARGER

Charger. Bamboe. Wireless 15W.
Ladegerät. Bambus. Drahtlos 15W.
Chargeur. Bamboe. Sans Fil 15W.
Oplader. Bamboe. Draadloos 15W.

14 x 12 x 6 cm 40 / 10 Print Code: E(4), L2, W



PD
POWER
DELIVERY

Cheviot 1428

Multifunction Holder. Wireless Charger 10W. Power Bank 5000 mAh. 2 USB and 1 Type C Outputs. Micro USB and Type C Input. Foldable. Adjustable Height and Angle.

Multifunktions Halter. Drahtlos Ladegerät 10W. Power Bank 5000 mAh. 2 USB und 1 Typ C Ausgänge. Micro USB und Typ C Eingang. Faltbar. Höhe und Winkel Verstellbar.

Support Multifonction. Chargeur Sans Fil 10W. Power Bank 5000 mAh. 2 Sorties USB et 1 Type C. Entrée Micro USB et Type C. Pliable. Hauteur et Angle Réglable. Multifunctioneel Houder. Draadloos Oplader 10W. Power Bank 5000 mAh. 2 USB en 1 Typ C Outputs. Micro USB en Type C Input. Opvouwbaar. Aanpasbaar Hoogte en Hoek.

6.6 x 12.3 x 11 cm 50 Print Code: E(1)



Meller 1965

((15W))
WIRELESS
CHARGER

Charger: Bamboo/ ABS. Wireless 15W. Foldable.

Ladegerät: Bambu/ ABS. Drahtlos 15W. Faltbar.

Chargeur: Bambou/ ABS. Sans Fil 15W. Pliable.

Oplader: Bamboe/ ABS. Draadloos 15W. Opvouwbaar.

11 x 2.3 x 7.7 cm 50 / 25 Print Code: E(1), L1, W



Macky 1958

Organizer Charger. Wireless 10W.

Ordner Ladegerät. Drahtlos 10W.

Chargeur Organiseur. Sans Fil 10W.

Organizer Oplader. Draadloos 10W.

8.6 x 7 x 8.6 cm 40 / 20 Print Code: E(4)



Tarmix 6544

Charger. Wireless 15W.

Ladegerät. Drahtlos 15W.

Chargeur. Sans Fil 15W.

Oplader. Draadloos 15W.

7 x 10.9 x 8.5 cm 50 / 25 Print Code: E(4)

Lomen 1083

((15W))
WIRELESS
CHARGER

Charger. Wireless 15W. Adjustable Height.

Ladegerät. Drahtlos 15W. Höhenverstellbar.

Chargeur. Sans Fil 15W. Hauteur Réglable.

Oplader. Draadloos 15W. Aanpasbaar Hoogte.

6.5 x 11 x 8.4 cm 100 / 50 Print Code: E(4)



Sterling 1469

Charger. Polyester 300D. Wireless 15W. Magnetic. Foldable.

Ladegerät. Polyester 300D. Drahtlos 15W. Magnetisch. Faltbar.

Chargeur. Polyester 300D. Sans Fil 15W. Magnétique. Pliable.

Oplader. Polyester 300D. Draadloos 15W. Magnetisch. Opvouwbaar.

8 x 13 x 8 cm 100 / 50 Print Code: F(1), N(8)



ADHESIVE
ACCESSORY
INCLUDED



Grodin 1419 (15W) WIRELESS CHARGER

Charger: Coconut, Wireless 15W.
Ladegerät: Kokosnuss, Drahtlos 15W.
Chargeur: Coco, Sans Fil 15W.
Oplader: Kokosnoot, Draadloos 15W.

9 x 13.5 x 7 cm 50 / 25 Print Code: E(1), L2, W



Birniac 6537

Charger: Wheat Straw/ ABS, Wireless 10W.
Ladegerät: Weizenstroh/ ABS, Drahtlos 10W.
Chargeur: Paille de Blé/ ABS, Sans Fil 10W.
Oplader: Tarwestro/ ABS, Draadloos 10W.

7 x 11.2 x 8.6 cm 50 / 25 Print Code: E(4)



Dimper 6521

Charger: Bamboo, Wireless 10W.
Ladegerät: Bambus, Drahtlos 10W.
Chargeur: Bambou, Sans Fil 10W.
Oplader: Bamboe, Draadloos 10W.

7 x 11.5 x 8 cm 50 / 25 Print Code: E(4), L2

LIMITED
edition
EXPERIENCE



Buisson 1350

Charger: Wheat Straw/ ABS/ Bamboo, Wireless 10W.
Ladegerät: Weizenstroh/ ABS/ Bambus, Drahtlos 10W.
Chargeur: Paille de Blé/ ABS/ Bambou, Sans Fil 10W.
Oplader: Tarwestro/ ABS/ Bamboe, Draadloos 10W.

7.7 x 12 x 10.2 cm 50 Print Code: E(1), F(1), L2



Wiket 6702

Charger: Limestone Cement/ Bamboo, Wireless 10W.
Ladegerät: Kalksteinzement/ Bambus, Drahtlos 10W.
Chargeur: Ciment Calcaire/ Bambou, Sans Fil 10W.
Oplader: Kalksteen Cement/ Bamboe, Draadloos 10W.

Ø 10 x 12.5 cm 30 Print Code: E(4), L2



Lupint 1209

PD
POWER
DELIVERY

Charger. Bamboo. Wireless 10W. 2 USB Outputs and 1 Type C Output.
Ladegerät. Bambus. Drahtlos 10W. 2 USB Ausgänge und 1 Typ C Ausgang.
Chargeur. Bambou. Sans Fil 10W. 2 Sorties USB et 1 Sortie Type C.
Oplader. Bamboe. Draadloos 10W. 2 USB Outputs en 1 Typ C Output.

18 x 7.4 x 11.5 cm 10 Print Code: G(1), L2



Tedy 1970

Charger. Bamboo/ Recycled Cardboard. Wireless 10W.
Ladegerät. Bambus/ Recycling Pappe. Drahtlos 10W.
Chargeur. Bambou/ Carton Recyclé. Sans Fil 10W.
Oplader. Bamboe/ Gerecycled Karton. Draadloos 10W.

13.5 x 1.1 x 6.9 cm 100/50 Print Code: E(4), L2, W



New

Sainford 21059

((15W))
WIRELESS
CHARGER

Multifunction Charger. Bamboo/ Metal. Wireless 15W. 50 Sticky Notes 4,5 x 4,5 cm. USB Output, Type C Output and Input.
Multifunktion Ladegerät. Bambus/ Metall. Drahtlos 15W. 50 Haftnotizen 4,5 x 4,5 cm. USB Ausgang, Typ C Ausgänge und Eingang.
Chargeur Multifonction. Bambou/ Métal. Sans Fil 15W. 50 Notes Adhésives 4,5 x 4,5 cm. Sortie USB. Sortie et Entrée Type C.
Multifunctioneel Oplader. Bamboe/ Metaal. Draadloos 15W. 50 Plakmemo's 4,5 x 4,5 cm. USB Output, Typ C Output en Input.

16.1 x 8 x 7.5 cm 100/25 Print Code: E(1), L2



Beny 1968

((15W))
WIRELESS
CHARGER

Organizer Charger. Cork/ Bamboo. Wireless 15W.
Ordner Ladegerät. Kork/ Bambus. Drahtlos 15W.
Chargeur Organiseur. Liège/ Bambou. Sans Fil 15W.
Organizer Oplader. Kurk/ Bamboe. Draadloos 15W.

27 x 14 x 1.8 cm 50/25 Print Code: E(4), L2, W



Lautrec 20843

WIRELESS CHARGER

Organizer Charger. Bamboo. Wireless 15W. Felt Tip Pen and Eraser Included.

Ordner Ladegerät. Bambus. Drahtlos 15W. Filzstift und Radierer Inklusiv.

Chargeur Organiseur. Bambou. Sans Fil 15W. Feutre et Effaceur Inclus.

Organizer Oplader. Bamboe. Draadloos 15W. Felt Tip Pen en Gum Inclusief.

Print Code: E(4), L2, W

Treit 20861

WIRELESS CHARGER

Organizer Charger. Bamboo. Wireless 15W.

Ordner Ladegerät. Bambus. Drahtlos 15W.

Chargeur Organiseur. Bambou. Sans Fil 15W.

Organizer Oplader. Bamboe. Draadloos 15W.

Print Code: E(4), L2, W



Loubron 1438

WIRELESS CHARGER

Organizer Charger. Bamboo. Wireless 15W. USB Output.

Ordner Ladegerät. Bambus. Drahtlos 15W. USB Ausgang.

Chargeur Organiseur. Bambou. Sans Fil 15W. Sortie USB.

Organizer Oplader. Bamboe. Draadloos 15W. USB Output.

Print Code: E(4), L2, W

Golbar 1439

WIRELESS CHARGER

Organizer Charger. Bamboo. Wireless 15W. USB Output.

Ordner Ladegerät. Bambus. Drahtlos 15W. USB Ausgang.

Chargeur Organiseur. Bambou. Sans Fil 15W. Sortie USB.

Organizer Oplader. Bamboe. Draadloos 15W. USB Output.

Print Code: E(4), L2, W



Eliot 21204

(15W)
WIRELESS
CHARGER

Charger. Bamboe. Wireless 15W. Magnetic. Charging Cable Set Included. Suitable for data transfer. Micro USB, Type C and Lightning Connection 5V DC 3A.
Ladegerät. Bambus. Drahtlos 15W. Ladegerät-kabel Set Inklusiv. Geeignet für die datenübertragung. Anschluss Micro USB, Typ C und Lightning 5V DC 3A.
Chargeur. Bamboe. Sans Fil 15W. Set Câbles du Chargeur Inclus. Convient au transfert de données. Connexion Micro USB, Type C et Lightning 5V DC 3A.
Oplader. Bamboe. Draadloos 15W. Opladkabel Set Inclusief. Geschikt voor data-overdracht. Micro USB, Type C en Lightning Connectie 5V DC 3A.

10.9 x 2.1 x 7.2 cm 100 / 50 Print Code: E(4), L2, W



Linya 21187

(15W)
WIRELESS
CHARGER

Multifunction Lamp. Bamboe/ ABS. 27 Leds. Foldable. Wireless Charger 15W.
Multifunktio Lampe. Bambus/ ABS. 27 Leds. Faltbar. Drahtlos Ladegerät 15W.
Lampe Multifonction. Bamboe/ ABS. 27 Leds. Pliable. Chargeur Sans Fil 15W.
Multifunctioneel Lamp. Bamboe/ ABS. 27 Leds. Opvouwbaar. Draadloos Oplader 15W.

Ø 9 x 1 cm 100 / 50 Print Code: E(4), L2



Nodens 1873

Charger Cup Warmer. Bamboe. Wireless 10W. USB Connection.
Tasse Wärmer Ladegerät. Bambus. Drahtlos 10W. Anschluss USB.
Chauffe Tasses Chargeur. Bamboe. Sans Fil 10W. Connexion USB.
Warmhoudplaatje Oplader. Bamboe. Draadloos 10W. USB Connectie.

18.2 x 1.3 x 9.7 cm 50 Print Code: E(4), L2, W



Claudix 6536

Charger. Wheat Straw/ ABS/ Bamboo. Wireless 10W.
Ladegerät. Weizenstroh/ ABS/ Bambus. Drahtlos 10W.
Chargeur. Paille de Blé/ ABS/ Bambou. Sans Fil 10W.
Oplader. Tarwestro/ ABS/ Bamboe. Draadloos 10W.

11.2 x 1.4 x 6.9 cm 50 / 25 Print Code: E(4)

Fiore 6668

Charger. Wheat Straw/ ABS/ Bamboo. Wireless 10W.
Ladegerät. Weizenstroh/ ABS/ Bambus. Drahtlos 10W.
Chargeur. Paille de Blé/ ABS/ Bambou. Sans Fil 10W.
Oplader. Tarwestro/ ABS/ Bamboe. Draadloos 10W.

Ø 6 x 1.1 cm 100 / 50 Print Code: E(4), L1, W

Nembar 6182

Charger. Bamboo/ ABS. Wireless 10W.
Ladegerät. Bambus/ ABS. Drahtlos 10W.
Chargeur. Bambou/ ABS. Sans Fil 10W.
Oplader. Bamboe/ ABS. Draadloos 10W.

Ø 10 x 0.7 cm 100 / 50 Print Code: E(4), L2, W



Aleix 6667

Charger. Wheat Straw/ ABS. Wireless 10W.
Ladegerät. Weizenstroh/ ABS. Drahtlos 10W.
Chargeur. Paille de Blé/ ABS. Sans Fil 10W.
Oplader. Tarwestro/ ABS. Draadloos 10W.

Ø 10 x 0.8 cm 50 / 25 Print Code: E(4), W

Riens 6534

Charger. Wheat Straw/ ABS. Wireless 10W. 2 USB Outputs.
Ladegerät. Weizenstroh/ ABS. Drahtlos 10W. 2 USB Ausgänge.
Chargeur. Paille de Blé/ ABS. Sans Fil 10W. 2 Sorties USB.
Oplader. Tarwestro/ ABS. Draadloos 10W. 2 USB Outputs.

9 x 0.9 x 9 cm 50 / 25 Print Code: E(4), W

Cirkal 6535

Charger. Wheat Straw/ ABS. Wireless 5W.
Ladegerät. Weizenstroh/ ABS. Drahtlos 5W.
Chargeur. Paille de Blé/ ABS. Sans Fil 5W.
Oplader. Tarwestro/ ABS. Draadloos 5W.

Ø 7 x 1 cm 50 / 25 Print Code: E(4), W



Hebant 6522

Charger: Bamboo, Wireless 10W.
Ladegerät: Bambus, Drahtlos 10W.
Chargeur: Bambou, Sans Fil 10W.
Oplader: Bamboe, Draadloos 10W.

📏 Ø 9.2 x 0.9 cm 📦 100 / 50 🗣️ Print Code: E(4), L2, W

Dumiaux 6542

Charger: Bamboo, Wireless 10W, 2 USB Outputs.
Ladegerät: Bambus, Drahtlos 10W, 2 USB Ausgänge.
Chargeur: Bambou, Sans Fil 10W, 2 Sorties USB.
Oplader: Bamboe, Draadloos 10W, 2 USB Outputs.

📏 9 x 0.9 x 9 cm 📦 50 / 25 🗣️ Print Code: E(4), L2, W

Vartol 6735

((15W))
WIRELESS
CHARGER

Charger: Bamboo, Wireless 15W.
Ladegerät: Bambus, Drahtlos 15W.
Chargeur: Bambou, Sans Fil 15W.
Oplader: Bamboe, Draadloos 15W.

📏 12.5 x 1.6 x 8 cm 📦 100 / 50 🗣️ Print Code: E(4), L2, W



Kibox 6699

Charger: Cork, Wireless 10W.
Ladegerät: Kork, Drahtlos 10W.
Chargeur: Liège, Sans Fil 10W.
Oplader: Kurk, Draadloos 10W.

📏 Ø 9.8 x 0.6 cm 📦 100 / 50 🗣️ Print Code: E(4), L2, W

Kronex 6739

Charger: Cork, Wireless 10W, 2 USB Outputs.
Ladegerät: Kork, Drahtlos 10W, 2 USB Ausgänge.
Chargeur: Liège, Sans Fil 10W, 2 Sorties USB.
Oplader: Kurk, Draadloos 10W, 2 USB Outputs.

📏 9.4 x 1 x 9.4 cm 📦 50 / 25 🗣️ Print Code: E(4), L2, W

Livor 6740

Charger: Wheat Straw/ ABS/ Cork, Wireless 10W.
Ladegerät: Weizenstroh/ ABS/ Kork, Drahtlos 10W.
Chargeur: Paille de Blé/ ABS/ Liège, Sans Fil 10W.
Oplader: Tarwestro/ ABS/ Kurk, Draadloos 10W.

📏 Ø 10 x 0.7 cm 📦 100 / 50 🗣️ Print Code: E(4), L2, W



Donson 5764

Charger. Wireless 10W. 2 USB Outputs.
 Ladegerät. Drahtlos 10W. 2 USB Ausgänge.
 Chargeur. Sans Fil 10W. 2 Sorties USB.
 Oplader. Draadloos 10W. 2 USB Outputs.

9 x 0.9 x 9 cm 50 Print Code: E(4), W



Radik 5324

Charger. Wireless 5W.
 Ladegerät. Drahtlos 5W.
 Chargeur. Sans Fil 5W.
 Oplader. Draadloos 5W.

7 x 0.9 cm 200 / 50 Print Code: E(4), W



Alanny 1206 ^(15W) WIRELESS CHARGER

Charger. Wireless 15W.
 Ladegerät. Drahtlos 15W.
 Chargeur. Sans Fil 15W.
 Oplader. Draadloos 15W.

10 x 1 cm 100 / 50 Print Code: E(4), W



Lumbert 6520

Charger. Wireless 10W.
 Ladegerät. Drahtlos 10W.
 Chargeur. Sans Fil 10W.
 Oplader. Draadloos 10W.

10 x 0.9 cm 100 / 50 Print Code: E(4), W





Raston 1420

Charger. Coconut. Wireless 10W. 2 USB Outputs.
 Ladegerät. Kokosnuss. Drahtlos 10W. 2 USB Ausgänge.
 Chargeur. Coco. Sans Fil 10W. 2 Sorties USB.
 Oplader. Kokosnoot. Draadloos 10W. 2 USB Outputs.

9.2 x 1.3 x 9.2 cm 50 / 25 Print Code: E(4), L2, W



Yeik 1296

Charger. Polyester RPET. Wireless 10W.
 Ladegerät. Polyester RPET. Drahtlos 10W.
 Chargeur. Polyester RPET. Sans Fil 10W.
 Oplader. Polyester RPET. Draadloos 10W.

10 x 1.1 x 6.2 cm 50 / 25 Print Code: E(1), N(8)



Brotox 6929

Charger. Recycled Cardboard/ Wheat Straw/ ABS. Wireless 5W.
 Ladegerät. Recycling Pappe/ Weizenstroh/ ABS. Drahtlos 5W.
 Chargeur. Carton Recyclé/ Paille de Blé/ ABS. Sans Fil 5W.
 Oplader. Gerecycled Karton/ Tarwestro/ ABS. Draadloos 5W.

Ø 6.4 x 3.8 cm 100 / 50 Print Code: D(4), W



Normux 6744

Charger. Limestone Cement/ Cork. Wireless 5W.
 Ladegerät. Kalksteinzement/ Kork. Drahtlos 5W.
 Chargeur. Ciment Calcaire/ Liège. Sans Fil 5W.
 Oplader. Kalksteen Cement/ Kurk. Draadloos 5W.

Ø 9 x 1.3 cm 50 / 25 Print Code: E(4), L2



Feskon 6701

Charger. Limestone Cement/ Bamboo. Wireless 5W.
 Ladegerät. Kalksteinzement/ Bambus. Drahtlos 5W.
 Chargeur. Ciment Calcaire/ Bambou. Sans Fil 5W.
 Oplader. Kalksteen Cement/ Bamboe. Draadloos 5W.

Ø 9 x 1.3 cm 50 / 25 Print Code: E(4), L2





Sarkul RCS 1982 ((15W))

WIRELESS CHARGER

Charger: Recycled Leather/ Recycled ABS. Wireless 15W.
Ladegerät: Recycling Leder/ Recycling ABS. Drahtlos 15W.
Chargeur: Cuir Recyclé/ ABS Recyclé. Sans Fil 15W.
Oplader: Gerecycled Leer/ Gerecycled ABS. Draadloos 15W.

📏 9.3 x 1.1 cm 📦 80 / 20 🗑️ Print Code: E(4), L2, W



19



01

02

03

Golop 1991 ((15W))

WIRELESS CHARGER

Charger: Recycled Aluminium. Wireless 15W.
Ladegerät: Recycling Aluminium. Drahtlos 15W.
Chargeur: Aluminium Recyclé. Sans Fil 15W.
Oplader: Gerecycled Aluminium. Draadloos 15W.

📏 9.9 x 0.6 cm 📦 100 / 50 🗑️ Print Code: E(4), W



Emerson 20274 ((15W))

WIRELESS CHARGER

Charger: Felt RPET/ Bamboe. Wireless 15W. 1 USB and 1 Type C Output.
Ladegerät: Filz RPET/ Bambus. Drahtlos 15W. 1 USB und 1 Typ C Ausgänge.
Chargeur: Feutrine RPET/ Bamboe. Sans Fil 15W. 1 Sortie USB et 1 Type C.
Oplader: Vilt RPET/ Bamboe. Draadloos 15W. 1 USB en 1 Typ C Output.

📏 9 x 1.6 x 9 cm 📦 100 / 50 🗑️ Print Code: E(1), L1, N(8)

Neubak 1972 ((15W))

WIRELESS CHARGER

Charger: Polyester RPET/ Bamboe. Wireless 15W.
Ladegerät: Polyester RPET/ Bambus. Drahtlos 15W.
Chargeur: Polyester RPET/ Bamboe. Sans Fil 15W.
Oplader: Polyester RPET/ Bamboe. Draadloos 15W.

📏 9.3 x 0.9 x 9.3 cm 📦 50 / 25 🗑️ Print Code: E(1), N(8)

Kuzgal 1975 ((15W))

WIRELESS CHARGER

Charger: Organic Hemp/ Wood. Wireless 15W.
Ladegerät: Organische Hanf/ Holz. Drahtlos 15W.
Chargeur: Chanvre Organique/ Bois. Sans Fil 15W.
Oplader: Organisch Hennep/ Hout. Draadloos 15W.

📏 9.8 x 1.2 cm 📦 100 / 50 🗑️ Print Code: E(1), L2, W

5000
mAh

Merak 6741

Power Bank. Wheat Straw/ ABS/ Cork. Wireless 5W. 5000 mAh. 2 USB Outputs. Type C Input.
 Power Bank. Weizenstroh/ ABS/ Kork. Drahtlos 5W. 5000 mAh. 2 USB Ausgänge. Typ C Eingang.
 Power Bank. Paille de Blé/ ABS/ Liège. Sans Fil 5W. 5000 mAh. 2 Sorties USB. Entrée Type C.
 Power Bank. Tarwestro/ ABS/ Kurk. Draadloos 5W. 5000 mAh. 2 USB Outputs. Typ C Input.

6.3 x 9.1 x 1.5 cm 50 / 25 Print Code: E(4), L2, W

8000
mAh

Limerick 1429 PD (15W) WIRELESS CHARGER

Power Bank. Cork/ Wheat Straw/ ABS. Wireless 15W. 8000 mAh. USB Output. Type C Output and Input.
 Power Bank. Kork/ Weizenstroh/ ABS. Drahtlos 15W. 8000 mAh. USB Ausgang. Typ C Ausgänge und Eingang.
 Power Bank. Liège/ Paille de Blé/ ABS. Sans Fil 15W. 8000 mAh. Sortie USB. Sortie et Entrée Type C.
 Power Bank. Kurk/ Tarwestro/ ABS. Draadloos 15W. 8000 mAh. USB Output. Typ C Output en Input.

7 x 15 x 1.8 cm 40 / 20 Print Code: E(4), L2, W

ANTONIO MIRO

5000
mAh

19

Baliok 7381

Power Bank. Wireless 5W. 5000 mAh. 2 USB and 1 Type C Outputs. Micro USB and Type C Input.
 Power Bank. Drahtlos 5W. 5000 mAh. 2 USB und 1 Typ C Ausgänge. Micro USB und Typ C Eingang.
 Power Bank. Sans Fil 5W. 5000 mAh. 2 Sorties USB et 1 Type C. Entrée Micro USB et Type C.
 Power Bank. Draadloos 5W. 5000 mAh. 2 USB en 1 Typ C Outputs. Micro USB en Type C Input.

6.8 x 14.3 x 1.8 cm 40 / 20 Print Code: E(4), W

4000
mAh

Tikur 6263

Power Bank. Aluminium. Wireless 5W. 4000 mAh. USB Output. Micro USB Input.
 Power Bank. Aluminium. Drahtlos 5W. 4000 mAh. USB Ausgang. Micro USB Eingang.
 Power Bank. Aluminium. Sans Fil 5W. 4000 mAh. Sortie USB. Entrée Micro USB.
 Power Bank. Aluminium. Draadloos 5W. 4000 mAh. USB Output. Micro USB Input.

7 x 12.2 x 1 cm 50 / 25 Print Code: E(4), W



09

03

02



Odwey 1440

Charger Holder. Wireless 10W. Adjustable.
 Ladegerät Halter. Drahtlos 10W. Verstellbar.
 Support Chargeur. Sans Fil 10W. Ajustable.
 Oplader Houder. Draadloos 10W. Aanpasbaar.

9.2 x 10 x 10 cm 50 / 25 Print Code: E(1)

8000
mAh

Yendik 1955

PD
POWER
DELIVERY

Power Bank. Wheat Straw/ ABS. Wireless 10W. 8000 mAh. 2 USB Outputs. Type C Output and Input.
Power Bank. Weizenstroh/ ABS. Drahtlos 10W. 8000 mAh. 2 USB Ausgänge. Typ C Ausgänge und Eingang.
Power Bank. Paille de Blé/ ABS. Sans Fil 10W. 8000 mAh. 2 Sorties USB. Sortie et Entrée Type C.
Power Bank. Tarwestro/ ABS. Draadloos 10W. 8000 mAh. 2 USB Outputs. Typ C Output en Input.

7.3 x 14.5 x 1.7 cm 40 / 20 Print Code: E(4), W

8000
mAh

Yerry RCS 1985

PD
POWER
DELIVERY

Power Bank. Recycled Leather/ Recycled ABS. Wireless 10W. 8000 mAh. 1 USB and 1 Type C Output. Micro USB and Type C Input.
Power Bank. Recycling Leder/ Recycling ABS. Drahtlos 10W. 8000 mAh. 1 USB und 1 Typ C Ausgänge. Micro USB und Typ C Eingang.
Power Bank. Cuir Recyclé/ ABS Recyclé. Sans Fil 10W. 8000 mAh. 1 Sortie USB et 1 Type C. Entrée Micro USB et Type C.
Power Bank. Gerecyclé Leer/ Gerecyclé ABS. Draadloos 10W. 8000 mAh. 1 USB en 1 Typ C Output. Micro USB en Type C Input.

6.9 x 14.2 x 1.7 cm 40 / 20 Print Code: E(4), L2, W

5000
mAh

Dralia 1987

PD
POWER
DELIVERY(15W)
WIRELESS
CHARGER

Power Bank. Bamboo. Wireless 15W. 5000 mAh. USB Output. Type C Output and Input.
Power Bank. Bambus. Drahtlos 15W. 5000 mAh. USB Ausgang. Typ C Ausgänge und Eingang.
Power Bank. Bambou. Sans Fil 15W. 5000 mAh. Sortie USB. Sortie et Entrée Type C.
Power Bank. Bamboe. Draadloos 15W. 5000 mAh. USB Output. Typ C Output en Input.

15 x 2 x 7.2 cm 50 / 25 Print Code: E(4), L2, W

8000
mAh

Dickens 6273

Power Bank. Bamboo/ ABS. Wireless 5W. 8000 mAh. 2 USB Outputs. Micro USB and Type C Input.

Power Bank. Bambus/ ABS. Drahtlos 5W. 8000 mAh. 2 USB Ausgänge. Micro USB und Typ C Eingang.

Power Bank. Bambou/ ABS. Sans Fil 5W. 8000 mAh. 2 Sorties USB. Entrée Micro USB et Type C.

Power Bank. Bamboe/ ABS. Draadloos 5W. 8000 mAh. 2 USB Outputs. Micro USB en Type C Input.

7.1 x 13.5 x 1.5 cm 50 / 25 Print Code: E(4), L2, W

5000
mAh

Gorix 6736

Power Bank. Wheat Straw/ ABS/ Bamboe. Wireless 5W. 5000 mAh. 2 USB Outputs. Type C Input.

Power Bank. Weizenstroh/ ABS/ Bambus. Drahtlos 5W. 5000 mAh. 2 USB Ausgänge. Typ C Eingang.

Power Bank. Paille de Blé/ ABS/ Bamboe. Sans Fil 5W. 5000 mAh. 2 Sorties USB. Entrée Type C.

Power Bank. Tarwestro/ ABS/ Bamboe. Draadloos 5W. 5000 mAh. 2 USB Outputs. Typ C Input.

6.3 x 9.1 x 1.5 cm 50 / 25 Print Code: E(4), L2, W



ADHESIVE
ACCESSORY
INCLUDED



Hataway 6895

Charger. Bamboo. Wireless 10W. Magnetic.
Ladegerät. Bambus. Drahtlos 10W. Magnetisch.
Chargeur. Bambou. Sans Fil 10W. Magnétique.
Oplader. Bamboe. Draadloos 10W. Magnetisch.

📏 6.8 x 0.8 cm 📦 200 / 100 🗣️ Print Code: E(4), L1



COMPATIBLE WITH
MAGSAFE & Qi
TECHNOLOGY



ADHESIVE
ACCESSORY
INCLUDED



COMPATIBLE WITH
MAGSAFE & Qi
TECHNOLOGY

Gonzo 1425

🔌 (15W) WIRELESS CHARGER
🔄 360°
📐 45°

Charger Holder. Bamboo. Wireless 15W. Magnetic.
Ladegerät Halter. Bambus. Drahtlos 15W. Magnetisch.
Support Chargeur. Bambou. Sans Fil 15W. Magnétique.
Oplader Houder. Bamboe. Draadloos 15W. Magnetisch.

📏 6.1 x 10 x 7.2 cm 📦 50 🗣️ Print Code: E(4), L2



ADHESIVE
ACCESSORY
INCLUDED



5000
mAh



COMPATIBLE WITH
MAGSAFE & Qi
TECHNOLOGY

🔌 PD POWER DELIVERY
🔌 (15W) WIRELESS CHARGER

Dobson 1424

Power Bank. Bamboo/ Cork. Wireless 15W. Magnetic. 5000 mAh. USB Output. Type C Output and Input.
Power Bank. Bambus/ Kork. Drahtlos 15W. Magnetisch. 5000 mAh. USB Ausgang. Typ C Ausgang und Eingang.
Power Bank. Bambou/ Liège. Sans Fil 15W. Magnétique. 5000 mAh. Sortie USB. Sortie et Entrée Type C.
Power Bank. Bamboe/ Kurk. Draadloos 15W. Magnetisch. 5000 mAh. USB Output. Typ C Output en Input.

📏 7.2 x 11 x 2.2 cm 📦 50 🗣️ Print Code: E(4), L2



COMPATIBLE WITH
MAGSAFE & Qi
TECHNOLOGY



02



New

01

Bellmer 20846 ((15W))
WIRELESS CHARGER

Charger. Aluminium. Wireless 15W. Magnetic.
Ladegerät. Aluminium. Drahtlos 15W. Magnetisch.
Chargeur. Aluminium. Sans Fil 15W. Magnétique.
Oplader. Aluminium. Draadloos 15W. Magnetisch.

Ø 6.4 x 0.8 cm 200 / 50 Print Code: E(1), L1, V, W



ADHESIVE
ACCESSORY
INCLUDED



ADHESIVE
ACCESSORY
INCLUDED

COMPATIBLE WITH
MAGSAFE & Qi
TECHNOLOGY

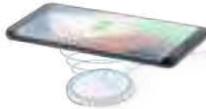

Makensy 6894

Charger. Aluminium. Wireless 10W. Magnetic.
Ladegerät. Aluminium. Drahtlos 10W. Magnetisch.
Chargeur. Aluminium. Sans Fil 10W. Magnétique.
Oplader. Aluminium. Draadloos 10W. Magnetisch.

Ø 6.2 x 0.6 cm 200 / 100 Print Code: E(4), L1



ADHESIVE
ACCESSORY
INCLUDED



01



02

5000
mAh

Vekmar 6923

Power Bank. Wireless 5W. Magnetic. 5000 mAh. Type C Input.
Power Bank. Drahtlos 5W. Magnetisch. 5000 mAh. Typ C Eingang.
Power Bank. Sans Fil 5W. Magnétique. 5000 mAh. Entrée Type C.
Power Bank. Draadloos 5W. Magnetisch. 5000 mAh. Typ C Input.

6.3 x 9.8 x 1.5 cm 50 / 25 Print Code: E(4), W

COMPATIBLE WITH
MAGSAFE & Qi
TECHNOLOGY



New

1200
mAh

02

Colak 21190

Power Bank. 1200 mAh. USB Output. Type C Output and Input.
 Power Bank. 1200 mAh. USB Ausgang. Typ C Ausgänge und Eingang.
 Power Bank. 1200 mAh. Sortie USB. Sortie et Entrée Type C.
 Power Bank. 1200 mAh. USB Output. Typ C Output en Input.

3 x 9 x 2.1 cm 100 / 25 Print Code: D(4), W



01

19

03



New

2200
mAh

Bamboo

Godimer 20844

Power Bank. Bamboo/ Wheat Straw/ ABS. 2200 mAh. USB Output. Type C Output and Input.
 Power Bank. Bambus/ Weizenstroh/ ABS. 2200 mAh. USB Ausgang. Typ C Ausgänge und Eingang.
 Power Bank. Bambou/ Paille de Blé/ ABS. 2200 mAh. Sortie USB. Sortie et Entrée Type C.
 Power Bank. Bamboe/ Tarwestro/ ABS. 2200 mAh. USB Output. Typ C Output en Input.

2.5 x 10.1 x 2.5 cm 100 / 25 Print Code: D(4), L1, W

2200
mAh

Hylin 1362

Power Bank. Aluminium. 2200 mAh. USB Output. Micro USB Input.
 Power Bank. Aluminium. 2200 mAh. USB Ausgang. Micro USB Eingang.
 Power Bank. Aluminium. 2200 mAh. Sortie USB. Entrée Micro USB.
 Power Bank. Aluminium. 2200 mAh. USB Output. Micro USB Input.

4.1 x 9.6 x 2.3 cm 50 / 25 Print Code: D(4), L1, W

2200
mAh

19

02

01

03

04

11

09

05

07

Thazer 4743

Power Bank. Aluminium. 2200 mAh. USB Output. Type C Output and Input.
 Power Bank. Aluminium. 2200 mAh. USB Ausgang. Typ C Ausgänge und Eingang.
 Power Bank. Aluminium. 2200 mAh. Sortie USB. Sortie et Entrée Type C.
 Power Bank. Aluminium. 2200 mAh. USB Output. Typ C Output en Input.

2.2 x 9.4 x 2.2 cm 100 / 25 Print Code: D(4), L1, W

2200
mAh

Blas 1361

Power Bank, Aluminium, 2200 mAh, USB Output, Micro USB Input.
 Power Bank, Aluminium, 2200 mAh, USB Ausgang, Micro USB Eingang.
 Power Bank, Aluminium, 2200 mAh, Sortie USB, Entrée Micro USB.
 Power Bank, Aluminium, 2200 mAh, USB Output, Micro USB Input.

6.8 x 11 x 1 cm 50 / 25 Print Code: E(4), L2, W

4000
mAh

Glird 1993

Power Bank, Aluminium, 4000 mAh, USB Output, Micro USB Input.
 Power Bank, Aluminium, 4000 mAh, USB Ausgang, Micro USB Eingang.
 Power Bank, Aluminium, 4000 mAh, Sortie USB, Entrée Micro USB.
 Power Bank, Aluminium, 4000 mAh, USB Output, Micro USB Input.

6.8 x 11 x 1 cm 50 / 25 Print Code: E(4), L2, W



02

03

19

23



New

4000
mAh

Fagar 20856

Power Bank, Aluminium, 4000 mAh, USB Output, Type C Output and Input.
 Power Bank, Aluminium, 4000 mAh, USB Ausgang, Typ C Ausgänge und Eingang.
 Power Bank, Aluminium, 4000 mAh, Sortie USB, Sortie et Entrée Type C.
 Power Bank, Aluminium, 4000 mAh, USB Output, Typ C Output en Input.

6.8 x 11 x 1 cm 50 / 25 Print Code: E(4), L2, W



02

09

4000
mAh

Ginval 1990

Power Bank, Recycled Aluminium, 4000 mAh, 2 USB Outputs, Type C Output and Input.
 Power Bank, Recycling Aluminium, 4000 mAh, 2 USB Ausgänge, Typ C Ausgänge und Eingang.
 Power Bank, Aluminium Recyclé, 4000 mAh, 2 Sorties USB, Sortie et Entrée Type C.
 Power Bank, Gerecycled Aluminium, 4000 mAh, 2 USB Outputs, Typ C Output en Input.

6.5 x 13 x 1 cm 50 / 25 Print Code: E(4), L2, W



03

02

19

09

ALUMINIUM
RECYCLED

5000
mAh

Bralty 1973

Power Bank. Polyester RPET/ Bamboe. 5000 mAh. 2 USB Outputs. Type C Output and Input.
 Power Bank. Polyester RPET/ Bambus. 5000 mAh. 2 USB Ausgänge. Typ C Ausgänge und Eingang.
 Power Bank. Polyester RPET/ Bamboe. 5000 mAh. 2 Sorties USB. Sortie et Entrée Type C.
 Power Bank. Polyester RPET/ Bamboe. 5000 mAh. 2 USB Outputs. Typ C Output en Input.

6.2 x 9.5 x 1.6 cm 50 / 25 Print Code: E(1), N(8)

6000
mAh

Kalery 6524

Power Bank. Bamboe. Wireless 5W. 6000 mAh. 2 USB Outputs. Type C Output and Input.
 Power Bank. Bambus. Drahtlos 5W. 6000 mAh. 2 USB Ausgänge. Typ C Ausgänge und Eingang.
 Power Bank. Bamboe. Sans Fil 5W. 6000 mAh. 2 Sorties USB. Sortie et Entrée Type C.
 Power Bank. Bamboe. Draadloos 5W. 6000 mAh. 2 USB Outputs. Typ C Output en Input.

7.4 x 14.8 x 1.7 cm 50 / 25 Print Code: E(4), L2, W

5000
mAh

Nipax 6523

Power Bank. Bamboe. 5000 mAh. USB Output. Type C Output and Input.
 Power Bank. Bambus. 5000 mAh. USB Ausgang. Typ C Ausgänge und Eingang.
 Power Bank. Bamboe. 5000 mAh. Sortie USB. Sortie et Entrée Type C.
 Power Bank. Bamboe. 5000 mAh. USB Output. Typ C Output en Input.

7 x 11.6 x 1.5 cm 50 / 25 Print Code: E(4), L2, W

8000
mAh

Meskat 1976

Power Bank. Organic Hemp/ Wood. 8000 mAh. 2 USB Outputs. Type C Output and Input.
 Power Bank. Organische Hanf/ Holz. 8000 mAh. 2 USB Ausgänge. Typ C Ausgänge und Eingang.
 Power Bank. Chanvre Organique/ Bois. 8000 mAh. 2 Sorties USB. Sortie et Entrée Type C.
 Power Bank. Organisch Hennep/ Hout. 8000 mAh. 2 USB Outputs. Typ C Output en Input.

6.9 x 13.2 x 1.6 cm 50 / 25 Print Code: E(1), L2, W





Lac 21197

Power Bank Earphones. Bambou/ ABS. 4500 mAh. USB Output. Type C Output and Input. Bluetooth Connection. Batterie 30 mAh.

Power Bank Kopfhörer. Bambus/ ABS. 4500 mAh. USB Ausgang. Typ C Ausgänge und Eingang. Bluetooth Anschluss. Batterie 30 mAh.

Écouteurs Power Bank. Bambou/ ABS. 4500 mAh. Sortie USB. Sortie et Entrée Type C. Connexion Bluetooth. Batterie 30 mAh.

Power Bank Oordopjes. Bamboe/ ABS. 4500 mAh. USB Output. Typ C Output en Input. Micro USB Input. Bluetooth Verbinding. Batterij 30 mAh.

📏 Ø 4 × 10 cm 📦 100 / 50 🖨️ Print Code: E(4), L1



Laford 21023

Power Bank. 5000 mAh. 2 Type C Outputs. Type C Input.

Power Bank. 5000 mAh. 2 Ausgang Typ C. Typ C Eingang.

Power Bank. 5000 mAh. 2 Sorties Type C. Entrée Type C.

Power Bank. 5000 mAh. 2 Typ C Output. Typ C Input.

📏 8 × 4.8 × 2.8 cm 📦 100 / 25 🖨️ Print Code: E(4)



Shiden 6539

Power Bank. Wheat Straw/ ABS. 5000 mAh. 2 USB Outputs. Micro USB Input.

Power Bank. Weizenstroh/ ABS. 5000 mAh. 2 USB Ausgänge. Micro USB Eingang.

Power Bank. Paille de Blé/ ABS. 5000 mAh. 2 Sorties USB. Entrée Micro USB.

Power Bank. Tarwestro/ ABS. 5000 mAh. 2 USB Outputs. Micro USB Input.

📏 6.3 × 9.4 × 1.4 cm 📦 50 / 25 🖨️ Print Code: E(4), W



Syrong 21223

Power Bank. Polyester RPET. 5000 mAh. 2 USB Outputs. Type C Output and Input.

Power Bank. Polyester RPET. 5000 mAh. 2 USB Ausgänge. Typ C Ausgänge und Eingang.

Power Bank. Polyester RPET. 5000 mAh. 2 Sorties USB. Sortie et Entrée Type C.

Power Bank. Polyester RPET. 5000 mAh. 2 USB Outputs. Typ C Output en Input.

📏 6.7 × 10 × 1.4 cm 📦 50 / 25 🖨️ Print Code: E(1), N(B)

GREAT CAPACITY

TECH GIFTS



03

10000
mAh

01

02

04

19

08

Kaprin 5779

Power Bank. 1 Led. 10000 mAh. 3 USB Outputs. Micro USB Input. Cable Not Included.
 Power Bank. 1 Led. 10000 mAh. 3 USB Ausgänge. Micro USB Eingang. Kabel Nicht im Lieferumfang.
 Power Bank. 1 Led. 10000 mAh. 3 Sorties USB. Entrée Micro USB. Câble Non Inclusive.
 Power Bank. 1 Led. 10000 mAh. 3 USB Outputs. Micro USB Input. Kabel Niet Inclusivef.

6.5 x 14.3 x 2.2 cm 40 / 10 Print Code: E(4), W



New

09

10000
mAh

02

Tornad 20857

Power Bank. Aluminium. 10000 mAh. 2 USB Output. 2 Type C Output and Input.
 Power Bank. Aluminium. 10000 mAh. 2 USB Ausgänge. 2 Typ C Ausgänge und Eingang.
 Power Bank. Aluminium. 10000 mAh. 2 Sorties USB. 2 Sorties et Entrées Type C.
 Power Bank. Aluminium. 10000 mAh. 2 USB Output. 2 Typ C Output en Input.

6.7 x 14.2 x 1.6 cm 40 / 20 Print Code: E(4), L2, W



New

20000
mAh

Golblum 21016

PD
POWER
DELIVERY

Power Bank. Wheat Straw/ ABS. 20000 mAh. 2 USB Outputs. Type C Output and Input.
 Power Bank. Weizenstroh/ ABS. 20000 mAh. 2 USB Ausgänge. Typ C Ausgänge und Eingang.
 Power Bank. Paille de Blé/ ABS. 20000 mAh. 2 Sorties USB. Sortie et Entrée Type C.
 Power Bank. Tarwestro/ ABS. 20000 mAh. 2 USB Outputs. Typ C Output en Input.

6.8 x 13.8 x 2.7 cm 30 / 10 Print Code: E(4), W



02

20000
mAh

Kiubert 6892

Power Bank. 20000 mAh. 2 USB Outputs. Type C Output and Input. Type C Input. Cable Not Included.
 Power Bank. 20000 mAh. 2 USB Ausgänge. Typ C Ausgänge und Eingang. Kabel Nicht im Lieferumfang.
 Power Bank. 20000 mAh. 2 Sorties USB. Sortie et Entrée Type C. Câble Non Inclusive.
 Power Bank. 20000 mAh. 2 USB Outputs. Typ C Output en Input. Kabel Niet Inclusivef.

6.8 x 13.8 x 2.5 cm 30 / 10 Print Code: E(4), W



01



SOLAR CHARGING



ADHESIVE ACCESSORY INCLUDED

COMPATIBLE WITH
MAGSAFE & Qi TECHNOLOGY



New



PD
POWER DELIVERY
WIRELESS CHARGER

Maddy 1422

Power Bank. Wireless 15W. Magnetic. 8000 mAh. Solar Charging. 2 USB Outputs. Type C Output and Input.
Power Bank. Drahtlos 15W. Magnetisch. 8000 mAh. Solarladung. 2 USB Ausgänge. Typ C Ausgänge und Eingang.
Power Bank. Sans Fil 15W. Magnétique. 8000 mAh. Charge Solaire. 2 Sorties USB. Sortie et Entrée Type C.
Power Bank. Draadloos 15W. Magnetisch. 8000 mAh. Zonnelading. 2 USB Outputs. Typ C Output en Input.

7.1 x 11.5 x 2.1 cm 40 / 10 Print Code: E(4)

8000 mAh



Dawson 20271

5000 mAh

Power Bank. Wheat Straw/ ABS. 5000 mAh. Solar Charging. 2 USB Outputs. Type C Output and Input.
Power Bank. Weizenstroh/ ABS. 5000 mAh. Solarladung. 2 USB Ausgänge. Typ C Ausgänge und Eingang.
Power Bank. Paille de Blé/ ABS. 5000 mAh. Charge Solaire. 2 Sorties USB. Sortie et Entrée Type C.
Power Bank. Tarwestro/ ABS. 5000 mAh. Zonnelading. 2 USB Outputs. Typ C Output en Input.

7.1 x 11.3 x 2 cm 40 / 10 Print Code: E(4), W

The solar energy is a renewable and clean energy. It does not pollute during its transformation process, contributing to the protection of the environment and reducing dependence on fossil fuels.



4000 mAh

Lenard 4939

Power Bank. 1 Flashing Led. 4000 mAh. Solar Charging. 2 USB Outputs. Micro USB Input.
Power Bank. 1 Led Blinkende. 4000 mAh. Solarladung. 2 USB Ausgänge. Micro USB Eingang.
Power Bank. 1 Led Clignotante. 4000 mAh. Charge Solaire. 2 Sorties USB. Entrée Micro USB.
Power Bank. 1 Knipperend Led. 4000 mAh. Zonnelading. 2 USB Outputs. Micro USB Input.

7.5 x 14.5 x 1.5 cm 50 / 25 Print Code: E(4)



19



02

03

09

4000 mAh

Rudder 6307

Power Bank. Aluminium. 4000 mAh. Solar Charging. USB Output. Micro USB Input.
Power Bank. Aluminium. 4000 mAh. Solarladung. USB Ausgang. Micro USB Eingang.
Power Bank. Aluminium. 4000 mAh. Charge Solaire. Sortie USB. Entrée Micro USB.
Power Bank. Aluminium. 4000 mAh. Zonnelading. USB Output. Micro USB Input.

7.8 x 12.5 x 1.4 cm 50 / 25 Print Code: E(4), L1, W



New

8000 mAh

Bernant 20858

Power Bank. Aluminium. 1 Led. 2 Light Modes, Fixed and Flashing. 8000 mAh. Solar Charging. 2 USB Outputs. Type C Output and Input.
Power Bank. Aluminium. 1 Led. 2 Lichtpositionen, Festes und Blinkendes. 8000 mAh. Solarladung. 2 USB Ausgänge. Typ C Ausgänge und Eingang.
Power Bank. Aluminium. 1 Led. 2 Modes de Lumière, Fixe et Clignotante. 8000 mAh. Charge Solaire. 2 Sorties USB. Sortie et Entrée Type C.
Power Bank. Aluminium. 1 Led. 2 Licht Posities, Vast en Knipperend. 8000 mAh. Zonnelading. 2 USB Outputs. Typ C Output en Input.

7.5 x 15 x 1 cm 50 / 25 Print Code: D(4), L1, W



SOLAR CHARGING



ADHESIVE
ACCESSORY
INCLUDED



New



5000
mAh

Gustaf 21045

PD
POWER
DELIVERY

((15W))
WIRELESS
CHARGER

COMPATIBLE WITH
MAGSAFE & Qi
TECHNOLOGY

Power Bank. Bamboo. Wireless 15W. Magnetic. 5000 mAh. Solar Charging. Type C Output and Input.
Power Bank. Bambus. Drahtlos 15W. Magnetisch. 5000 mAh. Solarladung. Typ C Ausgänge und Eingang.
Power Bank. Bambou. Sans Fil 15W. Magnétique. 5000 mAh. Charge Solaire. Sortie et Entrée Type C.
Power Bank. Bamboe. Draadloos 15W. Magnetisch. 5000 mAh. Zonnelading. Typ C Output en Input.

10.5 x 2.1 x 6.8 cm 40 / 20 Print Code: E(1), L1



New

5000
mAh

COMPATIBLE WITH
MAGSAFE & Qi
TECHNOLOGY

Haryin 21195

Power Bank. 1 Led. 2 Light Modes, Fixed and Flashing. Wireless 15W. Magnetic. 5000 mAh. Solar Charging. USB and Type C Output. Micro USB and Type C Input.
Power Bank. 1 Led. 2 Lichtpositionen, Festes und Blinkendes. Drahtlos 15W. Magnetisch. 5000 mAh. Solarladung. USB und Typ C Ausgang. Micro USB und Typ C Eingang.
Power Bank. 1 Led. 2 Modes de Lumière, Fixe et Clignotante. Sans Fil 15W. Magnétique. 5000 mAh. Sortie USB et Type C. Entrée Micro USB et Type C.
Power Bank. 1 Led. 2 Licht Posities, Vast en Knipperend. Draadloos 15W. Magnetisch. 5000 mAh. Zonnelading. USB en Type C Output. Micro USB en Type C Input.

6.8 x 10.7 x 2 cm 50 / 25 Print Code: E(1)



ADHESIVE
ACCESSORY
INCLUDED

The solar energy is a renewable and clean energy. It does not pollute during its transformation process, contributing to the protection of the environment and reducing dependence on fossil fuels.



The mark of
responsible forestry



4000
mAh

Molden 20859

Power Bank. Bamboo. 4000 mAh. Solar Charging. 2 USB Outputs. Type C Output and Input.
Power Bank. Bambus. 4000 mAh. Solarladung. 2 USB Ausgänge. Typ C Ausgänge und Eingang.
Power Bank. Bambou. 4000 mAh. Charge Solaire. 2 Sorties USB. Sortie et Entrée Type C.
Power Bank. Bamboe. 4000 mAh. Zonnelading. 2 USB Outputs. Typ C Output en Input.

7.3 x 15.5 x 1.4 cm 50 / 25 Print Code: E(4), L1, W



10000
mAh

Diuk 1234

Power Bank. Bamboo. Wireless 5W. 10000 mAh. Solar Charging. 2 USB and 1 Type C Outputs. Micro USB and Type C Input.
Power Bank. Bambus. Drahtlos 5W. 10000 mAh. Solarladung. 2 USB und 1 Typ C Ausgänge. Micro USB und Typ C Eingang.
Power Bank. Bambou. Sans Fil 5W. 10000 mAh. Charge Solaire. 2 Sorties USB et 1 Type C. Entrée Micro USB et Type C.
Power Bank. Bamboe. Draadloos 5W. 10000 mAh. Zonnelading. 2 USB en 1 Typ C Outputs. Micro USB en Type C Input.

7.8 x 14.9 x 2.2 cm 30 Print Code: E(4), L1



Cody 1435

PD
POWER
DELIVERY



2 in 1
MICRO USB &
LIGHTNING

Power Bank Set. 3 Accessories. Power Bank Wireless 5W, 4000 mAh, 1 USB and 1 Type C Output, Type C Input. USB Charger Fast Charger, 1 USB Output and 1 Type C Output. Charging Cable Suitable for data transfer, Extendable Cable, Micro USB, Type C and Lightning Connection 9V DC 2.1A.

Power Bank Set. 3 Teile. Power Bank Drahtlos 5W, 4000 mAh, 1 USB und 1 Typ C Ausgänge, Typ C Eingang, USB Ladegerät Schnelle Aufladung, 1 USB Ausgang und 1 Typ C Ausgang. Ladegerätkabel Geeignet für die datenübertragung, Ausziehbares Kabel, Anschluss Micro USB, Typ C und Lightning 9V DC 2.1A.

Set Power Bank. 3 Accessoires. Power Bank Sans Fil 5W, 4000 mAh, 1 Sortie USB et 1 Type C, Entrée Type C. Chargeur USB Charge Rapide, 1 Sortie USB et 1 Sortie Type C. Câble de Charge Convient au transfert de données, Câble Extensible, Connexion Micro USB, Type C et Lightning 9V DC 2.1A.

Power Bank Set. 3 Accessoires. Power Bank Draadloos 5W, 4000 mAh, 1 USB en 1 Typ C Output, Typ C Input. USB Oplader Snellader, 1 USB Output en 1 Typ C Output. Opladkabel Geschikt voor data-overdracht, Verlengbare Kabel, Micro USB, Type C en Lightning Connectie 9V DC 2.1A.

14 x 4 x 9.5 cm 40 Print Code: E(f), F(4), W



Joks 21025

Multifunction Travel Adapter. Wireless Charger 15W. Magnetic. Power Bank 10000 mAh. 2 Type C Outputs, 1 Micro USB/ Lightning Output and 1 USB Output. Type C Input. USA, Europe, Asia, UK, Australia.

Multifunktions Reise Adapter. Drahtlos Ladegerät 15W. Magnetisch. Power Bank 10000 mAh. 2 Typ C Ausgänge, 1 Micro USB/ Lightning Ausgang und 1 USB Ausgang. Typ C Eingang. USA, Europa, Asien, UK, Australien.

Adaptateur Voyage Multifonction. Chargeur Sans Fil 15W. Magnétique. Power Bank 10000 mAh. 2 Sorties Type C, 1 Sortie Micro USB/ Lightning et 1 Sortie USB. Entrée Type C. USA, Europe, Asie, Royaume-Uni, Australie.

Multifunctioneel Reis Adapter. Draadloos Oplader 15W. Magnetisch. Power Bank 10000 mAh. 2 Typ C Outputs, 1 Micro USB/ Lightning Output en 1 USB Output. Typ C Input. USA, Europa, Azië, UK, Australië.

8.4 x 8.4 x 3.4 cm 40/20 Print Code: E(4), W



Teimpor 6141

Multifunction Travel Adapter. Wireless Charger 5W. Power Bank 6700 mAh. 2 USB Outputs and 1 Type C Output. Type C Input. USA, Europe, Asia, UK, Australia.

Multifunktions Reise Adapter. Drahtlos Ladegerät 5W. Power Bank 6700 mAh. 2 USB Ausgänge und 1 Typ C Ausgang. Typ C Eingang. USA, Europa, Asien, UK, Australien.

Adaptateur Voyage Multifonction. Chargeur Sans Fil 5W. Power Bank 6700 mAh. 2 Sorties USB et 1 Sortie Type C. Entrée Type C. USA, Europe, Asie, Royaume-Uni, Australie.

Multifunctioneel Reis Adapter. Draadloos Oplader 5W. Power Bank 6700 mAh. 2 USB Outputs en 1 Typ C Output. Typ C Input. USA, Europa, Azië, UK, Australië.

2.9 x 8 x 8 cm 40 Print Code: E(4), W



Gregor 5162

USB Charger. 4 USB Outputs. 3100 mA.

USB Ladegerät. 4 USB Ausgänge. 3100 mA.

Chargeur USB. 4 Sorties USB. 3100 mA.

USB Oplader. 4 USB Outputs. 3100 mA.

2.8 x 8.6 x 6.8 cm 100/50 Print Code: E(4), W

New



Pylot 20291

PD
POWER
DELIVERY

IN/OUT
TYPE C

2-in-1
MICRO USB &
LIGHTNING

Chargers Set. Wheat Straw/ ABS. USB Charger Fast Charger, 1 USB Output and 1 Type C Output. Charging Cable Suitable for data transfer, Extendable Cable, Micro USB, Type C and Lightning Connection 9V DC 2.1A. Cotton Pouch.

Ladegerät Set. Weizenstroh/ ABS. USB Ladegerät Schnelle Aufladung, 1 USB Ausgang und 1 Typ C Ausgang. Ladekabel Geeignet für die datenübertragung, Ausziehbares Kabel, Anschluss Micro USB, Typ C und Lightning 9V DC 2.1A. Baumwolle Etui.

Set Chargeurs. Paille de Blé/ ABS. Chargeur USB Charge Rapide, 1 Sortie USB et 1 Sortie Type C. Câble de Charge Convient au transfert de données, Câble Extensible, Connexion Micro USB, Type C et Lightning 9V DC 2.1A. Étui Coton.

USB Opladers. Tarwestro/ ABS. USB Oplader Snellader, 1 USB Output en 1 Typ C Output. Opladkabel Geschikt voor data-overdracht, Verlengbare Kabel, Micro USB, Type C en Lightning Connectie 9V DC 2.1A. Katoen Zakje.

10 x 15 x 3 cm 100 / 50 Print Code: E(4), F(1), N(8), W



New

Vlind 20364

Plug Adapter. USB and Type C Output. USA, Europe, Asia, UK, Australia.

Steckeradapter. USB und Typ C Ausgang. USA, Europa, Asien, UK, Australien.

Adaptateur Prises. Sortie USB et Type C. USA, Europe, Asie, Royaume-Uni, Australie.

Stekker Adapter. USB en Type C Output. USA, Europa, Azië, UK, Australië.

3 x 5.4 x 4.7 cm 100 / 50 Print Code: E(4), W



Beigar 1627

PD
POWER
DELIVERY

Plug Adapter. 1 USB and 1 Type C Output. USA, Europe, Asia, UK, Australia. Velvet Pouch.

Steckeradapter. 1 USB und 1 Typ C Ausgänge. USA, Europa, Asien, UK, Australien. Wildleder Etui.

Adaptateur Prises. 1 Sortie USB et 1 Type C. USA, Europe, Asie, Royaume-Uni, Australie. Étui Suéline.

Stekker Adapter. 1 USB en 1 Typ C Output. USA, Europa, Azië, UK, Australië. Fluweel Zakje.

5 x 6.1 x 5.7 cm 100 / 50 Print Code: E(4), N(8), W



Golem 1437

PD
POWER
DELIVERY

USB Charger. Fast Charger. 1 USB Output and 1 Type C Output.
USB Ladegerät. Schnelle Aufladung. 1 USB Ausgang und 1 Typ C Ausgang.
Chargeur USB. Charge Rapide. 1 Sortie USB et 1 Sortie Type C.
USB Oplader. Snellader. 1 USB Output en 1 Typ C Output.

3.9 x 8 x 2.6 cm 100 / 50 Print Code: D(4), W



Avery 20270

PD
POWER
DELIVERY

USB Charger. Wheat Straw/ ABS. Fast Charger. 1 USB Output and 1 Type C Output.
USB Ladegerät. Weizenstroh/ ABS. Schnelle Aufladung. 1 USB Ausgang und 1 Typ C Ausgang.
Chargeur USB. Paille de Blé/ ABS. Charge Rapide. 1 Sortie USB et 1 Sortie Type C.
USB Oplader. Tarvestro/ ABS. Snellader. 1 USB Output en 1 Typ C Output.

3.9 x 8 x 2.6 cm 100 / 50 Print Code: D(4), W



Morelo 21033

PD
POWER
DELIVERY

USB Charger. Fast Charger. 1 Type C Output.
USB Ladegerät. Schnelle Aufladung. 1 Typ C Ausgang.
Chargeur USB. Charge Rapide. 1 Sortie Type C.
USB Oplader. Snellader. 1 Typ C Output.

4.3 x 7.9 x 2.7 cm 100 / 50 Print Code: D(4), W



Brunox 6574

USB Hub. Wheat Straw/ ABS. 4 Hubs. USB 2.0.
 USB Hub. Weizenstroh/ ABS. 4 Hubs. USB 2.0.
 Port USB. Paille de Blé/ ABS. 4 Ports. USB 2.0.
 USB Hub. Tarwestro/ ABS. 4 Poorten. USB 2.0.

📏 Ø 5.2 x 1.8 cm 📦 200 / 50 🔄 Print Code: D(4), W



Dagobat 1417



USB Hub. Coconut. 1 Hub Type C. 3 Hubs USB 2.0.
 USB Hub. Kokosnuss. 1 Typ C Hub. 3 Hubs USB 2.0.
 Port USB. Coco. 1 Port Type C. 3 Ports USB 2.0.
 USB Hub. Kokosnoot. 1 Type C Poort. 3 Poorten USB 2.0.

📏 9 x 2 x 5.8 cm 📦 200 / 50 🔄 Print Code: D(4), L1, W



Hasgar 1869



USB Hub. Recycled Cardboard. 1 Hub Type C. 2 Hubs USB 2.0.
 USB Hub. Recycling Pappe. 1 Typ C Hub. 2 Hubs USB 2.0.
 Port USB. Carton Recyclé. 1 Port Type C. 2 Ports USB 2.0.
 USB Hub. Gerecycled Karton. 1 Type C Poort. 2 Poorten USB 2.0.

📏 8 x 1.2 x 3.7 cm 📦 200 / 50 🔄 Print Code: D(4), W



Lasjar 1986



USB Hub. Bamboo. 1 Hub Type C. 2 Hubs USB 2.0.
 USB Hub. Bambus. 1 Typ C Hub. 2 Hubs USB 2.0.
 Port USB. Bamboe. 1 Port Type C. 2 Ports USB 2.0.
 USB Hub. Bamboe. 1 Type C Poort. 2 Poorten USB 2.0.

📏 Ø 6.3 x 1.5 cm 📦 200 / 50 🔄 Print Code: D(4), L1, W



Flow 21205



Holder USB Hub. Wheat Straw/ ABS/ Bamboe. 1 Hub Type C. 2 Hubs USB 2.0.
 Halter USB Hub. Weizenstroh/ ABS/ Bambus. 1 Typ C Hub. 2 Hubs USB 2.0.
 Port USB Support. Paille de Blé/ ABS/ Bamboe. 1 Port Type C. 2 Ports USB 2.0.
 Houder USB Hub. Tarwestro/ ABS/ Bamboe. 1 Type C Poort. 2 Poorten USB 2.0.

7.5 x 1.5 x 4.2 cm 200 / 50 Print Code: D(4), L1, W



Cirzo 20879



USB Hub. Bamboe. 1 Hub Type C. 2 Hubs USB 2.0.
 USB Hub. Bamboe. 1 Typ C Hub. 2 Hubs USB 2.0.
 Port USB. Bamboe. 1 Port Type C. 2 Ports USB 2.0.
 USB Hub. Bamboe. 1 Type C Poort. 2 Poorten USB 2.0.

8.3 x 1.6 x 5.2 cm 200 / 50 Print Code: D(4), L1, W



Barney 20276



USB Hub. Felt RPET/ Bamboe. 1 Hub Type C. 2 Hubs USB 2.0.
 USB Hub. Filz RPET/ Bambus. 1 Typ C Hub. 2 Hubs USB 2.0.
 Port USB. Feutrine RPET/ Bamboe. 1 Port Type C. 2 Ports USB 2.0.
 USB Hub. Vilt RPET/ Bamboe. 1 Type C Poort. 2 Poorten USB 2.0.

7.5 x 1.5 x 4.6 cm 100 / 50 Print Code: D(1), L1, N(8)



Norman 1140

USB Hub. Bamboe. 1 Hub Type C. 2 Hubs USB 2.0.
 USB Hub. Bamboe. 1 Typ C Hub. 2 Hubs USB 2.0.
 Port USB. Bamboe. 1 Port Type C. 2 Ports USB 2.0.
 USB Hub. Bamboe. 1 Type C Poort. 2 Poorten USB 2.0.

7.9 x 1 x 3.7 cm 200 / 50 Print Code: D(4), L1, W





ALUMINIUM RECYCLED

Kalat 1992



- USB Hub, Recycled Aluminium. 1 Hub Type C. 2 Hubs USB 2.0.
- USB Hub, Recycling Aluminium. 1 Typ C Hub. 2 Hubs USB 2.0.
- Port USB, Aluminium Recyclé. 1 Port Type C. 2 Ports USB 2.0.
- USB Hub, Gerecycled Aluminium. 1 Type C Poort. 2 Poorten USB 2.0.

7.9 x 1 x 3.7 cm 200 / 50 Print Code: D(1), L1, W

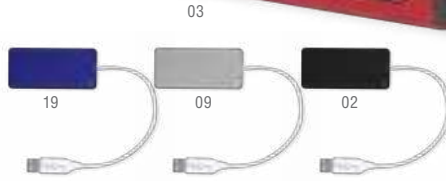

Weeper 5201

- USB Hub, Aluminium. 4 Hubs. USB 2.0.
- USB Hub, Aluminium. 4 Hubs. USB 2.0.
- Port USB, Aluminium. 4 Ports. USB 2.0.
- USB Hub, Aluminium. 4 Poorten. USB 2.0.

8.9 x 2.1 x 3.7 cm 200 / 50 Print Code: D(1), L1



Niyel 5199

- USB Hub. 4 Hubs. USB 2.0.
- USB Hub. 4 Hubs. USB 2.0.
- Port USB. 4 Ports. USB 2.0.
- USB Hub. 4 Poorten. USB 2.0.

Ø 5.2 x 1.8 cm 200 / 50 Print Code: D(4), W



8GB



Yeskal 8GB 1386

USB Memory.
USB Speicher.
Clé USB.
USB Memory.

2 x 5.8 x 1 cm 300 / 50
Print Code: D(4), L1



16GB



Rebik 16GB 5071

USB Memory.
USB Speicher.
Clé USB.
USB Memory.

2 x 5.8 x 1 cm 300 / 50
Print Code: D(4), L1



16GB



Survet 16GB 6236

USB Memory.
USB Speicher.
Clé USB.
USB Memory.

2 x 5.8 x 1 cm 300 / 50
Print Code: D(4), L1



32GB



Yemil 32GB 6052

USB Memory.
USB Speicher.
Clé USB.
USB Memory.

2 x 5.8 x 1 cm 300 / 50
Print Code: D(4), L1



16GB



Brabam 16GB 21216

USB Memory.
USB Speicher.
Clé USB.
USB Memory.

2 x 5.8 x 1 cm 300 / 50 Print Code: D(4), L1

USB 3.0

New



Ladny 16GB 21217 OTG

USB Memory, Type C Connection.
USB Speicher, Anschluss Typ C.
Clé USB, Connexion Type C.
USB Memory, Type C Connectie.

2 x 7 x 1 cm 500 / 50 Print Code: D(4), L1

16GB

USB 3.0



16GB



Laval 16GB 6242

USB Memory.
USB Speicher.
Clé USB.
USB Memory.

2 × 5.8 × 1 cm 500 / 50 Print Code: L1, V



16GB

New

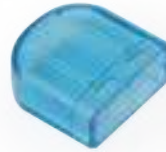

Steya 16GB 21215

USB Memory.
USB Speicher.
Clé USB.
USB Memory.

1.8 × 6.4 × 0.8 cm 500 / 50 Print Code: D(4)



16GB



Fixing 16GB 5846

USB Memory. Aluminium.
USB Speicher. Aluminium.
Clé USB. Aluminium.
USB Memory. Aluminium.

2.4 × 5.7 × 0.3 cm 200
Print Code: D(4), L1

16GB



Ditop 16GB 5847

USB Memory. Metal.
USB Speicher. Metall.
Clé USB. Métal.
USB Memory. Metaal.

1.2 × 4.1 × 0.4 cm 1000 / 100 Print Code: L1

16GB



Horiox 16GB 6238

USB Memory. Metal/ Acrylic. Led Lights.
USB Speicher. Metall/ Acryl. Led Lichten.
Clé USB. Métal/ Acrylique. Lumières Led.
USB Memory. Metaal/ Acryl. Led Lichten.

1.5 × 5.5 × 0.9 cm 250 / 50 Print Code: L1

16GB



Blidek 16GB 6240

USB Memory. Metal.
USB Speicher. Metall.
Clé USB. Métal.
USB Memory. Metaal.

2.4 × 6.1 × 0.5 cm 200 / 50 Print Code: L1



16G

Zilak 16GB 6232

USB Memory.
USB Speicher.
Clé USB.
USB Memory.

2,2 x 5,6 x 0,9 cm 500 / 50 Print Code: D(4), W



16G

Sondy 16GB 5848

USB Memory. PU Pouch.
USB Speicher. PU Etui.
Clé USB. Étui Similicuir.
USB Memory. PU Zakje.

5,2 x 8,3 x 0,3 cm 500 / 50 Print Code: D(4), W



16G

Milen 16GB 6233 OTG

USB Memory. Type C Connection.
USB Speicher. Anschluss Typ C.
Clé USB. Connexion Type C.
USB Memory. Type C Connectie.

5,2 x 8,4 x 0,5 cm 500 / 50 Print Code: D(4), W



16G

Domar 16GB 6560

USB Memory. Cork/ Glass.
USB Speicher. Kork/ Glas.
Clé USB. Liège/ Verre.
USB Memory. Kurk/ Glas.

2,9 x 5,7 cm 300 / 50 Print Code: D(4), L1



16G

Glyner 16GB 6559

USB Memory. Wheat Straw/ ABS.
USB Speicher. Weizenstroh/ ABS.
Clé USB. Paille de Blé/ ABS.
USB Memory. Tarvestro/ ABS.

5,2 x 8,3 x 0,3 cm 500 / 50 Print Code: D(4), W



16G

Zilda 16GB 6445

USB Memory. Bamboo.
USB Speicher. Bambus.
Clé USB. Bambou.
USB Memory. Bamboe.

5,4 x 9 x 0,5 cm 500 / 50 Print Code: D(4), W

PERMANENT STOCK



16G

Brounik 16GB 21214

USB Memory. Wheat Straw/ ABS.
 USB Speicher. Weizenstroh/ ABS.
 Clé USB. Paille de Blé/ ABS.
 USB Memory. Tarwestro/ ABS.

1.7 x 6 x 1 cm 500 / 50 Print Code: D(4), W



16G

Kursap 16GB 21213

USB Memory. Recycled ABS.
 USB Speicher. Recycling ABS.
 Clé USB. ABS Recyclé.
 USB Memory. Gerecycled ABS.

2 x 5.8 x 1 cm 500 / 50 Print Code: D(4), L1

16G

**Kontix 16GB 6470**

USB Memory. Wheat Straw/ ABS.
 USB Speicher. Weizenstroh/ ABS.
 Clé USB. Paille de Blé/ ABS.
 USB Memory. Tarwestro/ ABS.

1.7 x 5.9 x 0.9 cm 500 / 50 Print Code: D(4), W



16G

Mozil 16GB 6633

USB Memory. Wheat Straw/ ABS.
 USB Speicher. Weizenstroh/ ABS.
 Clé USB. Paille de Blé/ ABS.
 USB Memory. Tarwestro/ ABS.

1.9 x 5.7 x 0.9 cm 500 / 50 Print Code: D(4), L1



16G

Trugel 16GB 6228

USB Memory. Recycled Cardboard.
 USB Speicher. Recycling Pappé.
 Clé USB. Carton Recyclé.
 USB Memory. Gerecycled Karton.

2 x 5.8 x 1 cm 300 / 50 Print Code: D(4), L1



16G

Nosux 16GB 6561

USB Memory. Recycled Cardboard. Cork Pouch.
 USB Speicher. Recycling Pappé. Kork Etui.
 Clé USB. Carton Recyclé. Étui Liège.
 USB Memory. Gerecycled Karton. Kurk Zakje.

2.9 x 7 x 0.5 cm 500 / 50 Print Code: D(4), L1, W

16G

**Eku 16GB 6124**

USB Memory. Recycled Cardboard.
 USB Speicher. Recycling Pappé.
 Clé USB. Carton Recyclé.
 USB Memory. Gerecycled Karton.

Ø 1.8 x 6.7 cm 200 / 50 Print Code: D(4), W



New

Narvik 16GB 21211

USB Memory. Bamboo/ Aluminium.
 USB Speicher. Bambus/ Aluminium.
 Clé USB. Bambou/ Aluminium.
 USB Memory. Bamboe/ Aluminium.

1.5 × 6.5 × 0.6 cm 500 / 50 Print Code: D(4), L1, W

16GB



Haidam 16GB 6125

USB Memory. Bamboo.
 USB Speicher. Bambus.
 Clé USB. Bambou.
 USB Memory. Bamboe.

1.8 × 6.4 × 1.2 cm 300 / 50 Print Code: D(4), L1, W

16GB



Vedun 16GB 1308

USB Memory. Wood.
 USB Speicher. Holz.
 Clé USB. Bois.
 USB Memory. Hout.

2.2 × 6.4 × 1.3 cm 500 / 50 Print Code: D(4), L1, W

16GB



Cetrex 16GB 6229

USB Memory. Bamboo.
 USB Speicher. Bambus.
 Clé USB. Bambou.
 USB Memory. Bamboe.

2 × 5.8 × 1 cm 300 / 50 Print Code: D(4), L1

16GB



Nokex 16GB 1307

USB Memory. Wood.
 USB Speicher. Holz.
 Clé USB. Bois.
 USB Memory. Hout.

1.9 × 6 × 1 cm 500 / 50 Print Code: D(4), L1, W

16GB



New

Kluivert 16GB 21212 OTG

USB Memory. Wood. Type C Connection.
 USB Speicher. Holz. Anschluss Typ C.
 Clé USB. Bois. Connexion Type C.
 USB Memory. Hout. Type C Connectie.

2 × 7 × 1.2 cm 500 / 50 Print Code: D(4), L1, W

16GB





16G

Xaba 16GB 1593

USB Stylus Touch Ball Pen. Aluminium. Jumbo Refill.
Kugelschreiber Pointer USB. Aluminium. Jumbo Mine.
Stylus Bille USB. Aluminium. Recharge Jumbo.
USB Touch-Screen Balpen. Aluminium. Jumbo Refill.

Ø 1.1 x 14.7 cm 200 / 50 Print Code: B(4), D(1), L1



16G

Rond 16GB 1614

USB Ball Pen. Jumbo Refill.
Kugelschreiber USB. Jumbo Mine.
Stylo USB. Recharge Jumbo.
USB Balpen. Jumbo Refill.

Ø 1.2 x 14.5 cm 200 / 50 Print Code: B(4), D(1)



32GB

Lierok 32GB 7378

USB Ball Pen. Metal/ ABS.
Kugelschreiber USB. Metal/ ABS.
Stylo USB. Métal/ ABS.
USB Balpen. Metaal/ ABS.

Ø 1.3 x 14.5 cm 200 / 50 Print Code: D(4), L1



16G

Kornon 16GB 1235

USB Ball Pen. Wood.
Kugelschreiber USB. Holz.
Stylo USB. Bois.
USB Balpen. Hout.

Ø 1.8 x 14.5 cm 200 / 20 Print Code: D(1), B(4), L1



Sivart 16GB 5849

USB Stylus Touch Ball Pen. Metal.
Kugelschreiber Pointer USB. Metall.
Stylus Bille USB. Métal.
USB Touch-Screen Balpen. Metaal.

Ø 1.4 x 14 cm 100 / 20 Print Code: D(1), B(4), L1



16G

Boltuk 6201

USB Notepad. Cardboard. Hard Cover. 100 Sheets. USB Memory 16GB Included.
USB Notizblock. Pappe. Hardcover-Abdeckung. 100 Blätter. USB Speicher 16GB Inklusief.
Bloc Notes USB. Carton. Couverture Rigide. 100 Feuilles. Clé USB 16GB Inclusive.
USB Notitieblokje. Karton. Harde Kaft. 100 Blaadjes. USB Memory 16GB Inclusief.

14.2 x 21 x 1.5 cm 50 Print Code: F(4), T, W

16GB



100 Sheets Lined



asiaexpress
DIRECT IMPORTS SERVICE

import made easy



100%
customizable

New



Elington 20870

Mouse. Polyester RPET. Wireless. Optical. DPI Button. 1 Battery AA Not Included.

Maus. Polyester RPET. Drahtlos. Optisch. DPI Taste. 1 AA Batterie Nicht im Lieferumfang.

Souris. Polyester RPET. Sans Fil. Optique. Bouton DPI. 1 Pile AA Non Inclusive.

Muis. Polyester RPET. Draadloos. OpticaL. DPI Knop. 1 Batterij AA Niet Inclusief.

10.4 x 3.4 x 6.2 cm 200 / 100 Print Code: E(1)



Estiky 1198

Mouse. Wheat Straw/ ABS. Wireless. Optical. DPI Button. 1 Battery AA Not Included.

Maus. Weizenstroh/ ABS. Drahtlos. Optisch. DPI Taste. 1 AA Batterie Nicht im Lieferumfang.

Souris. Paille de Blé/ ABS. Sans Fil. Optique. Bouton DPI. 1 Pile AA Non Inclusive.

Muis. Tarwestro/ ABS. Draadloos. OpticaL. DPI Knop. 1 Batterij AA Niet Inclusief.

10.4 x 3.4 x 6.2 cm 200 / 100 Print Code: E(4), W



Diguan 1956

Mouse. Bamboo/ ABS. Wireless. Optical. 1 Battery AA Not Included.

Maus. Bambus/ ABS. Drahtlos. Optisch. 1 AA Batterie Nicht im Lieferumfang.

Souris. Bambou/ ABS. Sans Fil. Optique. 1 Pile AA Non Inclusive.

Muis. Bamboe/ ABS. Draadloos. OpticaL. 1 Batterij AA Niet Inclusief.

10.8 x 2.7 x 6 cm 200 / 100 Print Code: E(1), L1



01



05

19

Lyster 4624

Mouse. Wireless. Optical. DPI Button. 2 Batteries AAA Not Included.

Maus. Drahtlos. Optisch. DPI Taste. 2 AAA Batterien Nicht im Lieferumfang.

Souris. Sans Fil. Optique. Bouton DPI. 2 Piles AAA Non Inclusive.

Muis. Draadloos. OpticaL. DPI Knop. 2 Batterijen AAA Niet Inclusief.

11.2 x 2.4 x 5.7 cm 200 / 100 Print Code: E(4), W



Supot 6689

Antibacterial Mouse. Wireless. Optical. DPI Button. 2 Batteries AAA Not Included.

Antibacterieel Maus. Drahtlos. Optisch. DPI Taste. 2 AAA Batterien Nicht im Lieferumfang.

Souris Antibacterienne. Sans Fil. Optique. Bouton DPI. 2 Piles AAA Non Inclusive.

Antibacterieel Muis. Draadloos. OpticaL. DPI Knop. 2 Batterijen AAA Niet Inclusief.

11.2 x 2.4 x 5.7 cm 200 / 100 Print Code: E(4), W



02

03



Nuskir 1977

Charging Cable. Wheat Straw/ ABS/ Wood/ Organic Hemp. Micro USB, Type C and Lightning Connection 5V DC 2.4A.

Ladegerät-kabel. Weizenstroh/ ABS/ Holz/ Organische Hanf. Anschluss Micro USB, Typ C und Lightning 5V DC 2.4A.

Câble de Charge. Paille de Blé/ ABS/ Bois/ Chanvre Organique. Connexion Micro USB, Type C et Lightning 5V DC 2.4A.

Opladkabel. Tarwestro/ ABS/ Hou/ Organisch Hennep. Micro USB, Type C en Lightning Connectie 5V DC 2.4A.

3 x 28 x 1.3 cm 500 / 50
Print Code: D(4), L1



Denny 20260

Charging Cable. Wheat Straw/ ABS/ Bamboe/ Cotton. Micro USB, Type C and Lightning Connection 5V DC 2.4A.

Ladegerät-kabel. Weizenstroh/ ABS/ Bambus/ Baumwolle. Anschluss Micro USB, Typ C und Lightning 5V DC 2.4A.

Câble de Charge. Paille de Blé/ ABS/ Bamboe/ Coton. Connexion Micro USB, Type C et Lightning 5V DC 2.4A.

Opladkabel. Tarwestro/ ABS/ Bamboe/ Katoen. Micro USB, Type C en Lightning Connectie 5V DC 2.4A.

3,2 x 22 x 1 cm 500 / 100
Print Code: D(4), L1

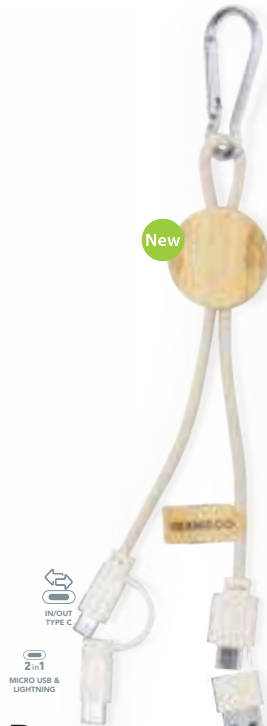

Braxton 20275

Charging Cable. Felt RPET/ Bamboe. Micro USB, Type C and Lightning Connection 5V DC 2.4A.

Ladegerät-kabel. Filz RPET/ Bambus. Anschluss Micro USB, Typ C und Lightning 5V DC 2.4A.

Câble de Charge. Feutrine RPET/ Bamboe. Connexion Micro USB, Type C et Lightning 5V DC 2.4A.

Opladkabel. Vilt RPET/ Bamboe. Micro USB, Type C en Lightning Connectie 5V DC 2.4A.

4 x 19 x 1.3 cm 500 / 50
Print Code: D(4), L1



Stuart 6924

Charging Cable. Cork/ Wheat Straw/ PP. Micro USB, Type C and Lightning Connection 5V DC 2.0A.

Ladegerät-kabel. Kork/ Weizenstroh/ PP. Anschluss Micro USB, Typ C und Lightning 5V DC 2.0A.

Câble de Charge. Liège/ Paille de Blé/ PP. Connexion Micro USB, Type C et Lightning 5V DC 2.0A.

Opladkabel. Kurk/ Tarwestro/ PP. Micro USB, Type C en Lightning Connectie 5V DC 2.0A.

5 x 16 x 0.8 cm 500 / 100
Print Code: D(4), L1



Feildin 1464

Charging Cable. Recycled Cardboard/ Wheat Straw/ ABS. Micro USB, Type C and Lightning Connection 5V DC 2.4A.

Ladegerät-kabel. Recycling Pappel/ Weizenstroh/ ABS. Anschluss Micro USB, Typ C und Lightning 5V DC 2.4A.

Câble de Charge. Carton Recyclé/ Paille de Blé/ ABS. Connexion Micro USB, Type C et Lightning 5V DC 2.4A.

Opladkabel. Gerecycled Karton/ Tarwestro/ ABS. Micro USB, Type C en Lightning Connectie 5V DC 2.4A.

Ø 1.8 x 16.5 cm 500 / 100
Print Code: D(1)



Dumof 1953

Charging Cable. Wheat Straw/ ABS. Micro USB, Type C and Lightning Connection 5V DC 2.4A.

Ladegerät-kabel. Weizenstroh/ ABS. Anschluss Micro USB, Typ C und Lightning 5V DC 2.4A.

Câble de Charge. Paille de Blé/ ABS. Connexion Micro USB, Type C et Lightning 5V DC 2.4A.

Opladkabel. Tarwestro/ ABS. Micro USB, Type C en Lightning Connectie 5V DC 2.4A.

3,4 x 18 x 1.2 cm 500 / 50
Print Code: D(4)



Sherat RCS 1981

Charging Cable. Recycled Leather/ Recycled ABS. Extendable Cable. Micro USB, Type C and Lightning Connection 5V DC 2.4A.

Ladegerät-kabel. Recycling Leder/ Recycling ABS. Ausziehbares Kabel. Anschluss Micro USB, Typ C und Lightning 5V DC 2.4A.

Câble de Charge. Cuir Recyclé/ ABS Recyclé. Câble Extensible. Connexion Micro USB, Type C et Lightning 5V DC 2.4A.

Opladkabel. Gerecycled Leer/ Gerecycled ABS. Verlengbare Kabel. Micro USB, Type C en Lightning Connectie 5V DC 2.4A.

5,5 x 100 x 2.4 cm 200 / 50
Print Code: D(4), L1



New



03

Freud 20845



Charging Cable. Recycled Aluminium. Extendable Cable. Micro USB, Type C and Lightning Connection 5V DC 2.4A.

Ladegerät-kabel. Recycling Aluminium. Ausziehbares Kabel. Anschluss Micro USB, Typ C und Lightning 5V DC 2.4A.

Câble de Charge. Aluminium Recyclé. Câble Extensible. Connexion Micro USB, Type C et Lightning 5V DC 2.4A.

Oplaaadkabel. Gerecycled Aluminium. Verlengbare Kabel. Micro USB, Type C en Lightning Connectie 5V DC 2.4A.

📏 92 x 6 x 1.4 cm 📦 500 / 100 🗣️ Print Code: E(1), L1, V



02

19

09



Rizzo 1418



Charging Cable. Coconut. Suitable for data transfer. Extendable Cable. Micro USB, Type C and Lightning Connection 9V DC 2.1A.

Ladegerät-kabel. Kokosnuss. Geeignet für die datenübertragung. Ausziehbares Kabel. Anschluss Micro USB, Typ C und Lightning 9V DC 2.1A.

Câble de Charge. Coco. Convient au transfert de données. Câble Extensible. Connexion Micro USB, Type C et Lightning 9V DC 2.1A.

Oplaaadkabel. Kokosnoot. Geschikt voor data-overdracht. Verlengbare Kabel. Micro USB, Type C en Lightning Connectie 9V DC 2.1A.

📏 80 x 4.1 x 1.5 cm 📦 400 / 100 🗣️ Print Code: E(1), L1



Kiotex 1202



Charging Cable. Suitable for data transfer. Extendable Cable. Micro USB, Type C and Lightning Connection 9V DC 2.1A.

Ladegerät-kabel. Geeignet für die datenübertragung. Ausziehbares Kabel. Anschluss Micro USB, Typ C und Lightning 9V DC 2.1A.

Câble de Charge. Convient au transfert de données. Câble Extensible. Connexion Micro USB, Type C et Lightning 9V DC 2.1A.

Oplaaadkabel. Geschikt voor data-overdracht. Verlengbare Kabel. Micro USB, Type C en Lightning Connectie 9V DC 2.1A.

📏 80 x 4.1 x 1.6 cm 📦 400 / 100 🗣️ Print Code: E(4)



Yarely 1954



Charging Cable. Wheat Straw/ ABS. Suitable for data transfer. Extendable Cable. Micro USB, Type C and Lightning Connection 9V DC 2.1A.

Ladegerät-kabel. Weizenstroh/ ABS. Geeignet für die datenübertragung. Ausziehbares Kabel. Anschluss Micro USB, Typ C und Lightning 9V DC 2.1A.

Câble de Charge. Paille de Blé/ ABS. Convient au transfert de données. Câble Extensible. Connexion Micro USB, Type C et Lightning 9V DC 2.1A.

Oplaaadkabel. Tarwestro/ ABS. Geschikt voor data-overdracht. Verlengbare Kabel. Micro USB, Type C en Lightning Connectie 9V DC 2.1A.

📏 80 x 4.1 x 1.5 cm 📦 400 / 100 🗣️ Print Code: E(4)



Chaconix 20292

Charging Cable Set. Bambou/ Wheat Straw/ ABS. Suitable for data transfer. Micro USB, Type C and Lightning Connection 5V DC 3A.

Ladegerät-kabel Set. Bambus/ Weizenstroh/ ABS. Geeignet für die datenübertragung. Anschluss Micro USB, Typ C und Lightning 5V DC 3A.

Set Câbles du Chargeur. Bambou/ Paille de Blé/ ABS. Convient au transfert de données. Connexion Micro USB, Type C et Lightning 5V DC 3A.

Oplaadkabel Set. Bamboe/ Tarwestro/ ABS. Geschikt voor data-overdracht. Micro USB, Type C en Lightning Connectie 5V DC 3A.

📏 8 x 1.6 cm 📦 200 / 50 🗣️ Print Code: E(4), L1, W



Lee 20261

Charging Cable Set. Wheat Straw/ ABS. Suitable for data transfer. Micro USB, Type C and Lightning Connection 5V DC 3A. SIM Card Ejector Included.

Ladegerät-kabel Set. Weizenstroh/ ABS. Geeignet für die datenübertragung. Anschluss Micro USB, Typ C und Lightning 5V DC 3A. SIM-Karten-Auswurfwerkzeug Inklusiv.

Set Câbles du Chargeur. Paille de Blé/ ABS. Convient au transfert de données. Connexion Micro USB, Type C et Lightning 5V DC 3A. Outil d'Éjection de Carte SIM Inclusive.

Oplaadkabel Set. Tarwestro/ ABS. Geschikt voor data-overdracht. Micro USB, Type C en Lightning Connectie 5V DC 3A. SIM-Kaartuitwerper Inclusief.

📏 8.6 x 1.1 x 5.7 cm 📦 200 / 50 🗣️ Print Code: E(4), W



Brayce 20258

Charging Cable. Wheat Straw/ ABS/ Bamboe. Micro USB, Type C and Lightning Connection 5V DC 2.4A.

Ladegerät-kabel. Weizenstroh/ ABS/ Bambus. Anschluss Micro USB, Typ C und Lightning 5V DC 2.4A.

Câble de Charge. Paille de Blé/ ABS/ Bamboe. Connexion Micro USB, Type C et Lightning 5V DC 2.4A.

Oplaadkabel. Tarwestro/ ABS/ Bamboe. Micro USB, Type C en Lightning Connectie 5V DC 2.4A.

📏 5.7 x 6.3 x 3.1 cm 📦 300 / 50 🗣️ Print Code: E(4), L1



Tich 21185

Charging Cable Set. Suitable for data transfer. Micro USB, Type C and Lightning Connection 5V DC 3A. SIM Card Ejector Included.

Ladegerät-kabel Set. Geeignet für die datenübertragung. Anschluss Micro USB, Typ C und Lightning 5V DC 3A. SIM-Karten-Auswurfwerkzeug Inklusiv.

Set Câbles du Chargeur. Convient au transfert de données. Connexion Micro USB, Type C et Lightning 5V DC 3A. Outil d'Éjection de Carte SIM Inclusive.

Oplaadkabel Set. Geschikt voor data-overdracht. Micro USB, Type C en Lightning Connectie 5V DC 3A. SIM-Kaartuitwerper Inclusief.

📏 10.8 x 1.6 x 3 cm 📦 200 / 25 🗣️ Print Code: D(4), W



PD
POWER
DELIVERY

IN/OUT
TYPE C

100cm

Skot 21037

Charging Cable. Suitable for data transfer. Type C Connection PD 65W.
Ladegerät-kabel. Geeignet für die datenübertragung. Anschluss Typ C PD 65W.
Câble de Charge. Convient au transfert de données. Connexion Type C PD 65W.
Oplaadkabel. Geschikt voor data-overdracht. Type C Connectie PD 65W.

📏 Ø 1.3 × 16.5 cm 📦 100 / 25 🗑️ Print Code: D(4)



Trentex 1204

IN/OUT
TYPE C

2 in 1
MICRO USB &
LIGHTNING

100cm

Charging Cable. Aluminium. Micro USB, Type C and Lightning Connection 5V DC 2.4A.
Ladegerät-kabel. Aluminium. Anschluss Micro USB, Typ C und Lightning 5V DC 2.4A.
Câble de Charge. Aluminium. Connexion Micro USB, Type C et Lightning 5V DC 2.4A.
Oplaadkabel. Aluminium. Micro USB, Type C en Lightning Connectie 5V DC 2.4A.

📏 Ø 4.7 × 10.3 cm 📦 100 / 50 🗑️ Print Code: E(1), F(1), L1



Russell 6925

IN/OUT
TYPE C

2 in 1
MICRO USB &
LIGHTNING

Charging Cable. Bamboo. Micro USB, Type C and Lightning Connection 5V DC 2.0A.
Ladegerät-kabel. Bambus. Anschluss Micro USB, Typ C und Lightning 5V DC 2.0A.
Câble de Charge. Bambou. Connexion Micro USB, Type C et Lightning 5V DC 2.0A.
Oplaadkabel. Bamboe. Micro USB, Type C en Lightning Connectie 5V DC 2.0A.

📏 4 × 10 × 0.8 cm 📦 500 / 100 🗑️ Print Code: D(4), L1, W



Abby 20259

IN/OUT
TYPE C

2 in 1
MICRO USB &
LIGHTNING

Charging Cable. Wheat Straw/ ABS/ Bamboo. Micro USB, Type C and Lightning Connection 5V DC 2A.
Ladegerät-kabel. Weizenstroh/ ABS/ Bamboe. Anschluss Micro USB, Typ C und Lightning 5V DC 2A.
Câble de Charge. Paille de Blé/ ABS/ Bamboe. Connexion Micro USB, Type C et Lightning 5V DC 2A.
Oplaadkabel. Tarwestro/ ABS/ Bamboe. Micro USB, Type C en Lightning Connectie 5V DC 2A.

📏 3.5 × 12.5 × 1.2 cm 📦 400 / 100 🗑️ Print Code: D(4), L1



IN/OUT
TYPE C

2 in 1
MICRO USB &
LIGHTNING

Drusek 1285

Multifunction Charging Cable. Bamboo. Micro USB, Type C and Lightning Connection 5V DC 2.4A.
Multifunktions Ladegerät-kabel. Bambus. Anschluss Micro USB, Typ C und Lightning 5V DC 2.4A.
Câble de Charge Multifonction. Bambou. Connexion Micro USB, Type C et Lightning 5V DC 2.4A.
Multifunctioneel Oplaadkabel. Bamboe. Micro USB, Type C en Lightning Connectie 5V DC 2.4A.

📏 2.7 × 15.5 × 1.5 cm 📦 300 / 50 🗑️ Print Code: D(4), L1, W



Paretz 21036



Charging Cable. Suitable for data transfer. Type C Connection PD 65W.
 Ladegerätakabel. Geeignet für die Datenübertragung. Anschluss Typ C PD 65W.
 Câble de Charge. Convient au transfert de données. Connexion Type C PD 65W.
 Oplaadkabel. Geschikt voor data-overdracht. Type C Connectie PD 65W.

3 x 7.2 x 1.7 cm 500 / 50 Print Code: C(4)



Pek 21043



Multifunction Charging Cable. Recycled Aluminium. Micro USB, Type C and Lightning Connection 5V DC 2.4A.
 Multifunktion Ladegerätakabel. Recycling Aluminium. Anschluss Micro USB, Typ C und Lightning 5V DC 2.4A.
 Câble de Charge Multifonction. Aluminium Recyclé. Connexion Micro USB, Type C et Lightning 5V DC 2.4A.
 Multifunctioneel Oplaadkabel. Gerecycled Aluminium. Micro USB, Type C en Lightning Connectie 5V DC 2.4A.

1.5 x 15 x 1.6 cm 400 / 100 Print Code: D(1), L1



Vitral 5843



Charging Cable. Micro USB, Type C and Lightning Connection 5V DC 1A.
 Ladegerätakabel. Anschluss Micro USB, Typ C und Lightning 5V DC 1A.
 Câble de Charge. Connexion Micro USB, Type C et Lightning 5V DC 1A.
 Oplaadkabel. Micro USB, Type C en Lightning Connectie 5V DC 1A.

21 x 1.5 x 0.8 cm 400 / 200 Print Code: D(1)



Frecles 1203



Charging Cable. Aluminium. Micro USB, Type C and Lightning Connection 5V DC 2.4A.
 Ladegerätakabel. Aluminium. Anschluss Micro USB, Typ C und Lightning 5V DC 2.4A.
 Câble de Charge. Aluminium. Connexion Micro USB, Type C et Lightning 5V DC 2.4A.
 Oplaadkabel. Aluminium. Micro USB, Type C en Lightning Connectie 5V DC 2.4A.

22 x 7.7 x 0.8 cm 500 / 50 Print Code: D(1), L1



Yustry 1691

Wall Clock. MDF. 1 Battery AA Not Included.
Wanduhr. MDF. 1 AA Batterie Nicht im Lieferumfang.
Pendule. MDF. 1 Pile AA Non Inclusive.
Wandklok. MDF. 1 Batterij AA Niet Inclusief.

📏 Ø 32 × 3.9 cm 📦 20 🖨️ Print Code: G(1)

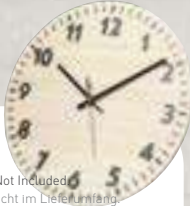

Kajim 1692

Wall Clock. MDF. 1 Battery AA Not Included.
Wanduhr. MDF. 1 AA Batterie Nicht im Lieferumfang.
Pendule. MDF. 1 Pile AA Non Inclusive.
Wandklok. MDF. 1 Batterij AA Niet Inclusief.

📏 Ø 30 × 3.9 cm 📦 20 🖨️ Print Code: G(1)



02

Prego 9301

Wall Clock. 1 Battery AA Not Included.
Wanduhr. 1 AA Batterie Nicht im Lieferumfang.
Pendule. 1 Pile AA Non Inclusive.
Wandklok. 1 Batterij AA Niet Inclusief.

📏 Ø 32 × 2.2 cm 📦 10
🖨️ Print Code: G(1)



19



03



AA/ R6 2308

4 Batteries Pack 1.5V.
Blister 4 Batterien 1,5V.
Blister 4 Piles 1,5V.
4 Batterijen Pak 1,5V.

📏 8.5 × 11.5 × 1.6 cm 📦 240 / 12
🖨️ Print Code: Consult.

AAA/ R03 2309

4 Batteries Pack 1.5V.
Blister 4 Batterien 1,5V.
Blister 4 Piles 1,5V.
4 Batterijen Pak 1,5V.

📏 8.4 × 11.4 × 1.2 cm 📦 288 / 12 🖨️ Print Code: Consult.

02 TECH ACCESSORIES





New



Harlux 21184

Holder Bracelet. Cotton/ Bamboo.
Halter Armband. Baumwolle/ Bambus.
Bracelet Support. Coton/ Bamboe.
Houder Armband. Katoen/ Bamboe.

📏 3.2 x 21 x 1 cm 📦 1000 / 100
🖨️ Print Code: E(1), L1, N(8)



New

11



Belaya 21247

Holder Bracelet. Polyester.
Halter Armband. Polyester.
Bracelet Support. Polyester.
Houder Armband. Polyester.

📏 2 x 16.5 cm 📦 1000 / 100
🖨️ Print Code: E(1), G(1), N(8)



New

02

Naomi 20242

Holder Bracelet. Silicone.
Halter Armband. Silikon.
Bracelet Support. Silicone.
Houder Armband. Siliconen.

📏 Ø 8.7 x 0.7 cm 📦 500 / 100
🖨️ Print Code: E(1), L1

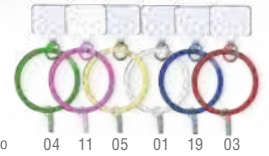

New



03

Hulak 21248

Holder Lanyard. Polyester.
Halter Schlüsselband. Polyester.
Lanyard Support. Polyester.
Houder Lanyard. Polyester.

📏 12.5 x 18.5 cm 📦 500 / 100
🖨️ Print Code: N(8)



06

Landry 1838

Multipurpose Bag. Polyester 600D RPET.
Mehrzwecktasche. Polyester 600D RPET.
Fourre-Tout. Polyester 600D RPET.
Multifunctioneel Tasje. Polyester 600D RPET.

📏 11.5 x 19.5 x 2 cm 📦 200 / 50
🖨️ Print Code: F(1), N(8), R



05

Rokdem 1610

Multipurpose Bag. PVC. Waterproof. Touch Screen.
Mehrzwecktasche. PVC. Wasserdicht. Touch Screen.
Fourre-Tout. PVC. Imperméable. Écran Tactile.
Multifunctioneel Tasje. PVC. Waterdicht. Touch Screen.

📏 10 x 23.5 cm 📦 500 / 50
🖨️ Print Code: F(1)





Sebly 20156

Lanyard. Silicone/ Polyester.
 Schlüsselband. Silikon/ Polyester.
 Lanyard. Silicone/ Polyester.
 Lanyard. Siliconen/ Polyester.

7 x 60 cm 300 / 50
 Print Code: G(1), L1



SUITABLE FOR ALL MOBILE PHONES

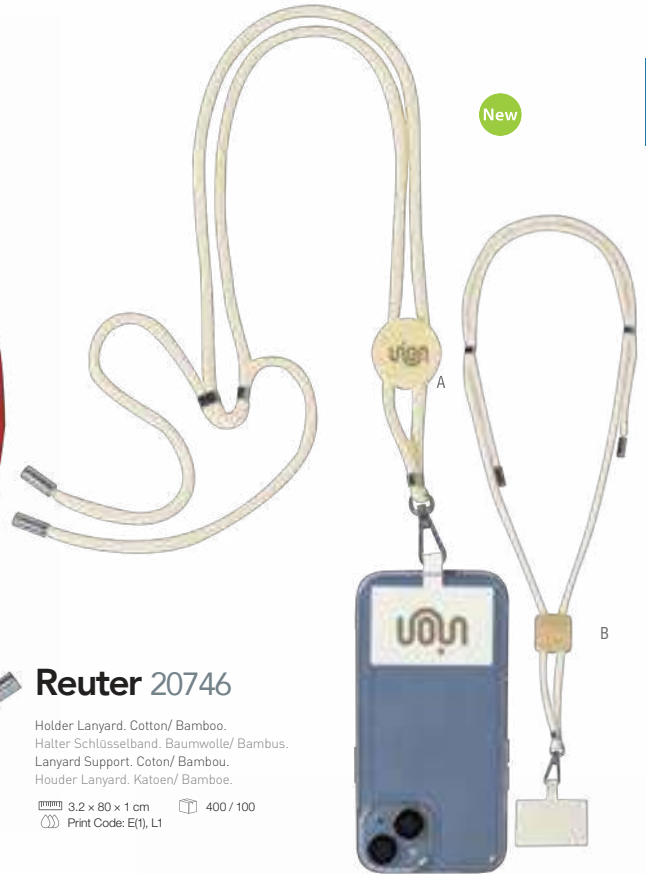

Reuter 20746

Holder Lanyard. Cotton/ Bamboo.
 Halter Schlüsselband. Baumwolle/ Bambus.
 Lanyard Support. Coton/ Bambou.
 Houder Lanyard. Katoen/ Bamboe.

3,2 x 80 x 1 cm 400 / 100
 Print Code: E(1), L1

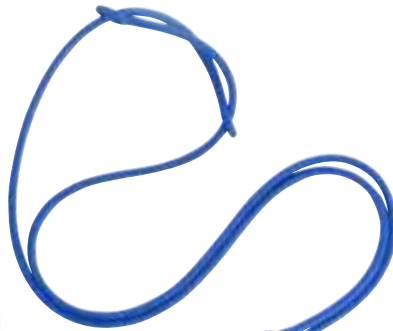

SUITABLE FOR ALL MOBILE PHONES



Veltux 5638

Lanyard. Silicone.
 Schlüsselband. Silikon.
 Lanyard. Silicone.
 Lanyard. Siliconen.

7 x 58 cm 300 / 50
 Print Code: G(1), L1



19



Kesey 20747

Holder Lanyard. Silicene.
 Halter Schlüsselband. Silikon.
 Lanyard Support. Silicene.
 Houder Lanyard. Siliconen.

6 x 62 cm 400 / 100
 Print Code: G(1), L1



04



Sherman 20767

Fan. 3 Modes. Battery 1200 mAh.
 Ventilator 3 Positionen. Batterie 1200 mAh.
 Ventilateur. 3 Modes. Batterie 1200 mAh.
 Ventilator. 3 Posities. Batterij 1200 mAh.

14 x 22 x 6.2 cm 50 Print Code: F(1)



New

19



01

02

03

Irvinton 20745

Fan. Flexible. Type C Connection.
 Ventilator. Flexibel. Anschluss Typ C.
 Ventilateur. Flexible. Connexion Type C.
 Ventilator. Flexibel. Type C Connectie.

8.7 x 14.2 x 1.7 cm 500 / 100 Print Code: E(1)

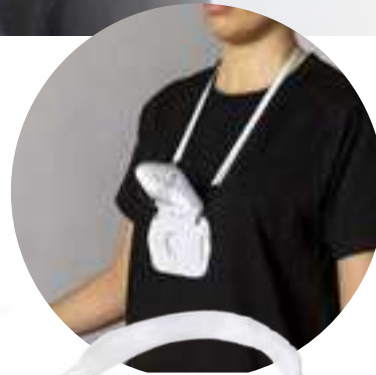

New



Benard 20766

Fan. Foldable. 3 Modes. Battery 400 mAh.
 Ventilator. Faltbar. 3 Positionen. Batterie 400 mAh.
 Ventilateur. Pliable. 3 Modes. Batterie 400 mAh.
 Ventilator. Opvouwbaar. 3 Posities. Batterij 400 mAh.

8 x 14.2 x 2.5 cm 50 Print Code: E(4)



2in1



Picmont 1080

Ring Light, 28 Leds, 3 Light Modes, Battery 80 mAh.
 Ringlicht, 28 Leds, 3 Lichtpositionen, Batterie 80 mAh.
 Anneau de Lumière, 28 Leds, 3 Modes de Lumière, Batterie 80 mAh.
 Lichtgevende Ring, 28 Leds, 3 Licht Posities, Batterij 80 mAh.

📏 Ø 8.5 x 2.7 cm 📦 200 / 50 🗑️ Print Code: D(1)



Traxo 20743

WHEAT STRAW

Ring Light, Wheat Straw/ ABS, 36 Leds, 3 Light Modes, Battery 80 mAh.
 Ringlicht, Weizenstroh/ ABS, 36 Leds, 3 Lichtpositionen, Batterie 80 mAh.
 Anneau de Lumière, Paille de Blé/ ABS, 36 Leds, 3 Modes de Lumière, Batterie 80 mAh.
 Lichtgevende Ring, Tarwestro/ ABS, 36 Leds, 3 Licht Posities, Batterij 80 mAh.

📏 Ø 8.5 x 2.7 cm 📦 200 / 50 🗑️ Print Code: D(1)



Spart 21188

Microphone, Type C Connection, Battery 45 mAh.
 Mikrofon, Anschluss Typ C, Batterie 45 mAh.
 Microphone, Connexion Type C, Batterie 45 mAh.
 Microfoon, Type C Connectie, Batterij 45 mAh.

📏 Ø 8 x 3.8 cm 📦 100 / 25 🗑️ Print Code: E(1)



Bercley 5244

Virtual Reality Glasses, Adjustable Lenses, Input Jack 3.5 mm.
 Virtual-Reality Brille, Verstellbare Linsen, 3.5 mm Klinkeneingänge.
 Lunettes de Réalité Virtuelle, Ajustables Lentilles, Connexion Jack 3,5 mm.
 Virtuele Reality Bril, Verstelbare Lenzen, Input Jack 3,5 mm.

📏 19.5 x 10.5 x 13.5 cm 📦 20 🗑️ Print Code: G(1)



Merylin 20245

Tripod, Stainless Steel/ ABS, Extendable, 5 Positions.
 Remote Shutter Included.
 Tripod, Rostfreier Stahl/ ABS, Ausziehbar, 5 Positionen.
 Fernauslöser Inklusiv.
 Trépied, Acier Inox/ ABS, Extensible, 5 Positions, Gâchette à Distance Incluse.
 Stativ, Roestvrij Staal/ ABS, Verlengbaar, 5 Posities.
 Afstandsbediening Inclusief.

📏 65 cm 📦 100 / 25 🗑️ Print Code: E(4)



EXTENDABLE 65 CM

New



Andigo 20867

Safety Set. Card RFID Protected, Bamboo. Webcam Cover Wheat Straw/ ABS, Adhesive. Data Blocker Wheat Straw/ ABS.
 Sicherheitsset. Karte RFID Schutz, Bambus. Webcam-Blocker Weizenstroh/ ABS, Haftend. Datenblocker Weizenstroh/ ABS.
 Set de Sécurité. Carte Protecteur RFID, Bambou. Bloqueur Webcam Paille de Blé/ ABS, Adhésif. Bloqueur de Données Paille de Blé/ ABS.
 Veiligheidsset. Kaart RFID Bescherming, Bamboe. Webcam Blocker Tarwestro/ ABS, Klevend. Datablokker Tarwestro/ ABS.

11 x 2.2 x 11 cm 100 / 50 Print Code: C(1), L2, W

RFID PROTECTION



Personal Alarm

Birnal 6405

Personal Alarm. Button Batteries Included.
 Persönlicher Alarm. Knopfzellen inklusive.
 Alarme personnelle. Piles Bouton incluses.
 Persoonlijk Alarm. Knopcel Batterijen Inclusief.

3.9 x 6 x 1.9 cm 300 / 50 Print Code: C(4)



APP
 COMPATIBLE WITH
 ANDROID & IOS

PARKING SITE SEARCHING
 LOCALIZADOR DE APARCAMIENTO

VOICE RECORDING
 GRABADORA

REMOTE SHUTTER
 DISPARADOR REMOTO

ANTI-LOST
 ANTI PERDIDA

Bluetooth®



01



Krosly 5160

Tracker: Bluetooth Connection. Button Battery Included.
 Piepser: Bluetooth Anschluss. Knopfzelle inklusive.
 Traqueur: Connexion Bluetooth. Pile Bouton incluse.
 Locator: Bluetooth Verbinding. Knopcel Batterij Inclusief.

3.1 x 5.2 x 1 cm 200 / 50 Print Code: C(4)



6 in 1
MULTI-FUNCTION

New



Tousend 20748

Cleaning Set. 6 Functions. Liquid Not Included.
Reinigungsset. 6 Funktionen. Flüssigkeit Nicht im Lieferumfang.
Set Nettoyage. 6 Fonctions. Liquide Non Inclusive.
Schoonmaak Set. 6 Functies. Vloeistof Niet Inclusief.

5 x 10 x 2.9 cm 100 / 25 Print Code: E(4)



New

6 in 1
MULTI-FUNCTION

Gobit 20749

Cleaner Pen. 4 Functions.
Reinigungs Kugelschreiber. 4 Funktionen.
Stylo Nettoyeur. 4 Fonctions.
Reinigungs Pen. 4 Functies.

Ø 1.2 x 14 cm 400 / 100 Print Code: B(4)

02

01



MULTIFUNCTION



New



Zygon 20744

Pouch. Lycra. Adhesive.
Hülle. Lycra. Haltend.
Étui. Lycra. Adhésif.
Hoes. Lycra. Klevend.

7.5 x 13.1 cm 500 / 100 Print Code: D(1), N(8)



Glitzo 20750

Holder. Adhesive and Magnetic.
Halter. Haftend und Magnetisch.
Support. Adhésif et Magnétique.
Houder. Klevend en Magnetisch.

3 x 12 x 0.5 cm 400 / 50 Print Code: D(1)





Linkil 21176

Holder. Foldable.
Halter. Faltbar.
Support. Pliable.
Houder. Opvouwbaar.

6 x 6.6 x 8 cm 200 / 100 Print Code: C(4)



Reviton 1082

Holder. Foldable. Adjustable Height and Angle.
Halter. Faltbar. Höhe und Winkel Verstellbar.
Support. Pliable. Hauteur et Angle Réglable.
Houder. Opvouwbaar. Aanpasbaar Hoogte en Hoek.

6.6 x 12.3 x 11 cm 100 / 50 Print Code: E(1)



Marxel 21175

Holder. Aluminium/ ABS. Foldable. Adjustable Angle.
Halter. Aluminium/ ABS. Faltbar. Winkel Verstellbar.
Support. Aluminium/ ABS. Pliable. Angle Réglable.
Houder. Aluminium/ ABS. Opvouwbaar. Hoogte en Hoek.

Ø 9.5 x 20 cm 50 / 10 Print Code: E(1), L1



Manyx 21063

Holder. Wheat Straw/ ABS/ Bamboo. Foldable. Adjustable Height and Angle.
Halter. Weizenstroh/ ABS/ Bambus. Faltbar. Höhe und Winkel Verstellbar.
Support. Paille de Blé/ ABS/ Bambou. Pliable. Hauteur et Angle Réglable.
Houder. Tarwestro/ ABS/ Bamboe. Opvouwbaar. Aanpasbaar Hoogte en Hoek.

12 x 20 x 6.8 cm 100 / 50 Print Code: E(1), L1



Olan 20862

Holder Lamp. Wheat Straw/ ABS. 12 Leds. Adjustable Height. Adjustable Brightness. Battery 1.200 mAh.
Halter Lampe. Weizenstroh/ ABS. 12 Leds. Höhenverstellbar. Einstellbare Lichtintensität. Batterie 1.200 mAh.
Lampe Support. Paille de Blé/ ABS. 12 Leds. Hauteur Réglable. Lumière à Intensité Réglable. Batterie 1.200 mAh.
Houder Lamp. Tarwestro/ ABS. 12 Leds. Aanpasbaar Hoogte. Lamp met Instelbare Lichtintensiteit. Batterij 1.200 mAh.

9 x 15.3 x 5.4 cm 50 Print Code: E(1)



Delim 6795

Holder. Bamboo.
Halter. Bambus.
Support. Bambou.
Houder. Bamboe.

📏 6 x 2 x 8 cm 📦 200 / 50 🗣️ Print Code: D(4), L1, W

Protok 6797

Holder. Bamboo.
Halter. Bambus.
Support. Bambou.
Houder. Bamboe.

📏 8 x 12 x 8.1 cm 📦 100 / 50 🗣️ Print Code: D(4), L2, W



New

Kosinen 20914

Organizer. Bamboo.
Ordner. Bambus.
Organiseur. Bambou.
Organizer. Bamboe.

📏 8 x 3.7 x 8 cm 📦 100 / 50 🗣️ Print Code: D(1), L1



Suijin 1879

Sound Amplifier. Bamboo.
Sound-Verstärker. Bambus.
Amplificateur Sonore. Bambou.
Geluidsversterker. Bamboe.

📏 10 x 3.3 x 6 cm 📦 100 / 50 🗣️ Print Code: D(4), L1, W



Lemins 1294

Holder. Bamboo.
Halter. Bambus.
Support. Bambou.
Houder. Bamboe.

📏 17 x 1.2 x 7.6 cm 📦 100 / 50 🗣️ Print Code: D(4), L2, W



Medrus 1609

Holder. Wood/ Cotton. Foldable. 2 Positions.
Halter. Holz/ Baumwolle. Faltbar. 2 Positionen.
Support. Bois/ Coton. Pliable. 2 Positions.
Houder. Hout/ Katoen. Opvouwbaar. 2 Posities.

📏 12.3 x 10.1 x 11 cm 📦 200 / 50 🗣️ Print Code: D(1), N(8)

New



Kosof 21032

Holder: Bamboo.
Halter: Bambus.
Support: Bambou.
Houder: Bamboe.

9.2 x 2.2 x 9.5 cm 500 / 50 Print Code: B(4), L1, W

WHEAT
STRAW



Lastrow 6786

Holder: Wheat Straw/ PP.
Halter: Weizenstroh/ PP.
Support: Paille de Blé/ PP.
Houder: Tarwestro/ PP.

8.5 x 3 x 8.5 cm 500 / 100 Print Code: B(4), W



Laxo 4108

Holder:
Halter:
Support:
Houder:

8.5 x 3 x 8.5 cm 500 / 100 Print Code: B(4), W

New



Asher 20243

Holder: Foldable.
Halter: Faltbar.
Support: Pliable.
Houder: Opvouwbaar.

3.6 x 7.5 x 6 cm 1000 / 100
Print Code: C(4)

New



Angie 20244

Holder: Foldable. Mirror Included.
Halter: Faltbar. Spiegel Inklusief.
Support: Pliable. Miroir Inclusive.
Houder: Opvouwbaar. Spiegel Inclusief.

7.2 x 7.5 x 10 cm 300 / 100
Print Code: C(4)

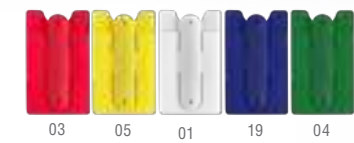

Blizz 4679

Multipurpose Pouch. Silicone. Adhesive.
Mehrzweckhülle. Silikon. Haftend.
Étui Multi-Usages. Silicone. Adhésif.
Multifunctionele Hoes. Siliconen. Klevend.

5.6 x 9.5 x 0.5 cm 500 / 100 Print Code: L1

**WHEAT
STRAW**

Glasgol 1409

Multifunction Keyring. Wheat Straw/ ABS. Screen Cleaner Included.
 Multifunktion Schlüsselanhänger. Weizenstroh/ ABS. Displayreiniger Inklusiv.
 Porte-Clés Multifonction. Paille de Blé/ ABS. Nettoyeur d'Écran Inclus.
 Multifunctioneel Houder. Tarwestro/ ABS. Screen Cleaner Inclusief.

 2.5 x 8.5 x 0.4 cm  1000 / 500  Print Code: C(4)

Peix 1911 ³ⁱⁿ¹ MULTI-FUNCTION



Llavero Soporte. Caña de Trigo/ ABS. Limpiapantallas Incluido.
 Porta-Chaves Suporte. Palha de Trigo/ ABS. Limpa Ecrã Incluído.
 Holder Keyring. Wheat Straw/ ABS. Screen Cleaner Included.

 2 x 4.8 x 1.3 cm  1000 / 100  Print Code: C(4), W



Figue 21124

Holder Keyring. Recycled Aluminium.
 Schlüsselanhänger Halter. Recycling Aluminium.
 Porte-Clés Support. Aluminium Recyclé.
 Sleutelhanger Houder. Gerecycled Aluminium.

 1.9 x 5.7 x 1.9 cm  1000 / 100
 Print Code: D(1), L1



BAMBOO

 Made in Europe

Evans 2618

Holder Keyring. Bamboo.
 Schlüsselanhänger Halter. Bambus.
 Porte-Clés Support. Bambou.
 Sleutelhanger Houder. Bamboe.

 2.5 x 8 x 0.3 cm  1600 / 400  Print Code: C(4), L1



Zeke 1408

Holder Keyring. Bamboo.
 Schlüsselanhänger Halter. Bambus.
 Porte-Clés Support. Bambou.
 Sleutelhanger Houder. Bamboe.

 3.8 x 7.4 x 0.6 cm  1000 / 100  Print Code: C(4), L1



Maros 6796

Holder Keyring. Bamboo.
 Schlüsselanhänger Halter. Bambus.
 Porte-Clés Support. Bambou.
 Sleutelhanger Houder. Bamboe.

 2.6 x 6 x 1.5 cm  500 / 100  Print Code: D(4), L1, W



19

Quiton 6084

Holder. Adhesive. 3 Functions.
Halter. Haftend. 3 Funktionen.
Support. Adhésif. 3 Fonctions.
Houder. Klevend. 3 Functies.

📏 Ø 3.3 × 0.6 cm 📦 2000 / 1000
🖨️ Print Code: B(4), W



Pashel 1949

Holder. Bamboo/ ABS. Adhesive. 3 Functions.
Halter. Bambou/ ABS. Haftend. 3 Funktionen.
Support. Bambou/ ABS. Adhésif. 3 Fonctions.
Houder. Bamboe/ ABS. Klevend. 3 Functies.

📏 Ø 4.3 × 0.5 cm 📦 2000 / 200
🖨️ Print Code: B(4), L1



Farti 1948

Holder. Bamboo/ ABS. Adhesive. 3 Functions.
Halter. Bambou/ ABS. Haftend. 3 Funktionen.
Support. Bambou/ ABS. Adhésif. 3 Fonctions.
Houder. Bamboe/ ABS. Klevend. 3 Functies.

📏 3.5 × 6.5 × 0.6 cm 📦 1000 / 200
🖨️ Print Code: B(4), L1



Sustre 6685

Antibacterial Holder. Adhesive. 3 Functions.
Antibakteriell Halter. Haftend. 3 Funktionen.
Support Antibacterienne. Adhésif. 3 Fonctions.
Antibacterieel Houder. Klevend. 3 Functies.

📏 Ø 3.3 × 0.6 cm 📦 2000 / 1000
🖨️ Print Code: B(4), W

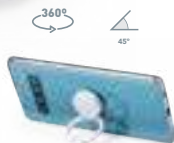

Kumol 6686

Antibacterial Holder. Adhesive.
Antibakteriell Halter. Haftend.
Support Antibacterienne. Adhésif.
Antibacterieel Houder. Klevend.

📏 Ø 4.4 × 2.9 cm 📦 1000 / 100
🖨️ Print Code: B(4), W



WHEAT STRAW Chelun 6592

Holder. Wheat Straw/ ABS. Adhesive.
Halter. Weizenstroh/ ABS. Haftend.
Support. Paille de Blé/ ABS. Adhésif.
Houder. Tarwestro/ ABS. Klevend.

📏 Ø 4.4 × 2.9 cm 📦 1000 / 100
🖨️ Print Code: B(4), W



Hunabik 6591

Holder. Adhesive.
Halter. Haftend.
Support. Adhésif.
Houder. Klevend.

📏 Ø 4.4 × 2.9 cm 📦 1000 / 100
🖨️ Print Code: B(4), W



Kafu 6780

Holder. Metal. Adhesive.
Halter. Metall. Haftend.
Support. Métal. Adhésif.
Houder. Metaal. Klevend.

📏 3 × 3 × 0.4 cm 📦 1000 / 100
🖨️ Print Code: B(4), L1



Arnold 5551

Holder. Adhesive.
Halter. Haftend.
Support. Adhésif.
Houder. Klevend.

📏 3.5 × 4 × 0.6 cm 📦 2000 / 1000
🖨️ Print Code: B(4)



23

09

02

01



SUITABLE FOR ALL DEVICES



02



19

Lacol 5801

Webcam Cover. Adhesive.
Webcam-Blocker. Haftend.
Bloqueur Webcam. Adhésif.
Webcam Blocker. Klevend.

4.1 x 1.6 x 0.2 cm 10000 / 5000 Print Code: C(4), W

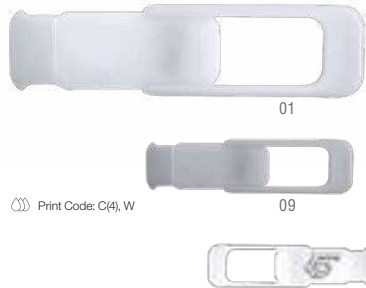

01

09

Nambus 6179

Webcam Cover. Adhesive.
Webcam-Blocker. Haftend.
Bloqueur Webcam. Adhésif.
Webcam Blocker. Klevend.

3.2 x 1.3 x 0.1 cm 10000 / 5000
Print Code: B(1), W



01

08

05

04

03

02

07



Hislot 6687

Antibacterial Webcam Cover. Adhesive.
Antibakteriell Webcam-Blocker. Haftend.
Bloqueur Webcam Antibacterienne. Adhésif.
Antibacterieel Webcam Blocker. Klevend.

3.2 x 1.3 x 0.1 cm 10000 / 5000 Print Code: C(1), W



WHEAT STRAW

Fildon 6575

Webcam Cover. Wheat Straw/ ABS. Adhesive.
Webcam-Blocker. Weizenstroh/ ABS. Haftend.
Bloqueur Webcam. Paille de Blé/ ABS. Adhésif.
Webcam Blocker. Tarwestro/ ABS. Klevend.

4.1 x 1.6 x 0.2 cm 10000 / 5000 Print Code: B(1), W



Recycled Cardboard



Baley 1462

Webcam Cover. Recycled Paper/ ABS. Adhesive.
Webcam-Blocker. Recycling Papier/ ABS. Haftend.
Bloqueur Webcam. Papier Recyclé/ ABS. Adhésif.
Webcam Blocker. Gerecyclé Papier/ ABS. Klevend.

3.2 x 1.3 x 0.1 cm 10000 / 5000 Print Code: B(1), W

SPECIAL HOLDER

**Halom 1297**

Holder. Foldable. Adjustable Height. Velvet Pouch.
 Halter. Faltbar. Höhenverstellbar. Wildleder Etui.
 Support. Pliable. Hauteur Réglable. Étui Suédine.
 Houder. Opvouwbaar. Aanpasbaar Hoogte. Fluweel Zakje.

20.4 x 15.5 x 26.5 cm 30 Print Code: G(1), L2, N(8)

**Morlon 1085**

Holder. Aluminium. Foldable. Adjustable Height. Velvet Pouch.
 Halter. Aluminium. Faltbar. Höhenverstellbar. Wildleder Etui.
 Support. Aluminium. Pliable. Hauteur Réglable. Étui Suédine.
 Houder. Aluminium. Opvouwbaar. Aanpasbaar Hoogte. Fluweel Zakje.

25.5 x 11 x 28.7 cm 30 Print Code: G(1), L2, N(8)

**Koimar 1942**

Holder. ABS. Foldable. 2 Positions.
 Halter. ABS. Faltbar. 2 Positionen.
 Support. ABS. Pliable. 2 Positions.
 Houder. ABS. Opvouwbaar. 2 Posities.

16.8 x 13.5 x 13.8 cm 200 / 50 Print Code: D(1)



Bamboo

NATURAL CORK



Luan 1367

Organizer Mousepad. Bamboo/ Cork/ Polyester. Anti-Slip.
 Ordner Mauspad. Bambus/ Kork/ Polyester. Rutschfest.
 Tapis Souris Organiseur. Bambou/ Liège/ Polyester. Antidérapant.
 Organizer Muispad. Bamboe/ Kurk/ Polyester. Anti-Slip.

54 x 5.7 x 30 cm 5 Print Code: H(1), L2



Krit 1900

Organizer Mousepad. Bamboo/ Cork. Anti-Slip.
 Ordner Mauspad. Bambus/ Kork. Rutschfest.
 Tapis Souris Organiseur. Bambou/ Liège. Antidérapant.
 Organizer Muispad. Bamboe/ Kurk. Anti-Slip.

52 x 6 x 29 cm 4 Print Code: H(1), L2

03 OFFICE & BUSINESS





**ESSENTIALS,
USEFUL,
FUNCTIONAL**



TO CHARGE YOUR
SMARTPHONE,
HEADPHONES
AND
SMARTWATCH

5000
mAh



Morrison 20248

Multifunction Notepad. Polyester 300D RPET. Wireless Charger 10W. Power Bank 5000 mAh. 65 Sheets Notepad. Type C Output and Input.
Multifunktion Notizblock. Polyester 300D RPET. Drahtlos Ladegerät 10W. Power Bank 5000 mAh. 65 Blätter Notizblock. Typ C Ausgänge und Eingang.
Bloc Notes Multifonction. Polyester 300D RPET. Chargeur Sans Fil 10W. Power Bank 5000 mAh. Sortie USB. Entrée Micro USB.
Multifunctioneel Notitieblokje. Polyester 300D RPET. Draadloos Oplader 10W. Power Bank 5000 mAh. 65 Blaadjes Notepad. Typ C Output en Input.

18 x 22.5 x 3 cm 20 Print Code: G(1), N(8)



ADHESIVE
ACCESSORY
INCLUDED

New

4000
mAh



Surey 6327

Power Bank Organizer. PU/ Polyester 300D. Wireless 5W. 4000 mAh. 64 Sheets Notepad. USB Output. Micro USB Input.
Power Bank Ordner. PU/ Polyester 300D. Drahtlos 5W. 4000 mAh. 64 Blätter Notizblock. USB Ausgang. Micro USB Eingang.
Organiseur Power Bank. Similicuir/ Polyester 300D. Sans Fil 5W. 4000 mAh. Bloc 64 Feuilles. Sortie USB. Entrée Micro USB.
Power Bank Organizer. PU/ Polyester 300D. Draadloos 5W. 4000 mAh. 64 Blaadjes Notepad. USB Output. Micro USB Input.

18.5 x 25.5 x 3.7 cm 20 Print Code: G(1), L2



5000
mAh



Dambier 1466

Multifunction Notepad. Polyester 300D RPET. Wireless Charger 10W. Power Bank 5000 mAh. USB Output. Micro USB Input. 65 Sheets Notepad.
Multifunktion Notizblock. Polyester 300D RPET. Drahtlos Ladegerät 10W. Power Bank 5000 mAh. USB Ausgang. Micro USB Eingang. 65 Blätter Notizblock.
Bloc Notes Multifonction. Polyester 300D RPET. Chargeur Sans Fil 10W. Power Bank 5000 mAh. Sortie USB. Entrée Micro USB. Bloc 65 Feuilles.
Multifunctioneel Notitieblokje. Polyester 300D RPET. Draadloos Oplader 10W. Power Bank 5000 mAh. USB Output. Micro USB Input. 65 Blaadjes Notepad.

17.5 x 22.5 x 2 cm 20 Print Code: G(1), N(8)



ADHESIVE
ACCESSORY
INCLUDED

5000
mAh



Harbur 1465

Multifunction Folder. Polyester 300D RPET. Wireless Charger 10W. Power Bank 5000 mAh. USB Output. Micro USB Input. 20 Sheets Notepad.
Multifunktion Mappe. Polyester 300D RPET. Drahtlos Ladegerät 10W. Power Bank 5000 mAh. USB Ausgang. Micro USB Eingang. 20 Blätter Notizblock.
Porte-Documents Multifonction. Polyester 300D RPET. Chargeur Sans Fil 10W. Power Bank 5000 mAh. Sortie USB. Entrée Micro USB. Bloc 20 Feuilles.

Multifunctioneel Map. Polyester 300D RPET. Draadloos Oplader 10W. Power Bank 5000 mAh. USB Output. Micro USB Input. 20 Blaadjes Notepad.

23.5 x 31 x 2 cm 10 Print Code: G(1), N(8)



ADHESIVE
ACCESSORY
INCLUDED



Hossian 20247 ((15W))

WIRELESS CHARGER

Multifunction Mousepad. Polyester 300D RPET/ Velvet/ Bamboe. Foldable. Wireless Charger 15W. Anti-Slip.
 Multifunktion Mauspad. Polyester 300D RPET/ Wildleder/ Bambus. Faltbar. Drahtlos Ladegerät 15W. Rutschfest.
 Tapis Souris Multifonction. Polyester 300D RPET/ Suédine/ Bamboe. Pliable. Chargeur Sans Fil 15W. Antidérapant.
 Multifunctioneel Muispad. Polyester 300D RPET/ Fluweel/ Bamboe. Opvouwbaar. Draadloos Oplader 15W. Anti-Slip.

📏 20.5 x 26 cm 📦 40 🗣️ Print Code: E(4), L1, N(8)

Craig 20246

Multifunction Mousepad. Polyester 300D RPET/ Velvet/ Bamboe. 1 Hub Type C. 4 Hubs USB 2.0. Anti-Slip.
 Multifunktion Mauspad. Polyester 300D RPET/ Wildleder/ Bambus. 1 Typ C Hub. 4 Hubs USB 2.0. Rutschfest.
 Tapis Souris Multifonction. Polyester 300D RPET/ Suédine/ Bamboe. 1 Port Type C. 4 Ports USB 2.0. Antidérapant.
 Multifunctioneel Muispad. Polyester 300D RPET/ Fluweel/ Bamboe. 1 Type C Poort. 4 Poorten USB 2.0. Anti-Slip.

📏 22 x 24 cm 📦 40 🗣️ Print Code: E(4), L1, N(8)



WIRELESS CHARGER

Deuz 20860

Charger Mousepad. Polyester 300D RPET. Wireless 15W. Anti-Slip.
 Ladegerät Mauspad. Polyester 300D RPET. Drahtlos 15W. Rutschfest.
 Tapis Souris Chargeur. Polyester 300D RPET. Sans Fil 15W. Antidérapant.
 Oplader Muispad. Polyester 300D RPET. Draadloos 15W. Anti-Slip.

📏 31 x 27 cm 📦 20 🗣️ Print Code: E(4), N(8)



Bistol 1366

Charger Mousepad. Bamboe. Wireless 10W. Anti-Slip.
 Ladegerät Mauspad. Bamboe. Drahtlos 10W. Rutschfest.
 Tapis Souris Chargeur. Bamboe. Sans Fil 10W. Antidérapant.
 Oplader Muispad. Bamboe. Draadloos 10W. Anti-Slip.

📏 Ø 21 x 0.8 cm 📦 50 🗣️ Print Code: F(1), L2



Relium 6615

Charger Mousepad. Cork/ Velvet. Wireless 5W. Anti-Slip.
Ladegerät Mauspad. Kork/ Wildleder. Drahtlos 5W. Rutschfest.
Tapis Souris Chargeur. Liège/ Suédine. Sans Fil 5W. Antidérapant.
Oplader Muispad. Kurk/ Fluweel. Draadloos 5W. Anti-Slip.

26.5 x 20.5 cm 50 Print Code: F(1), L2, N(8)



Kimy 1194

Charger Mousepad. Polyester 300D RPET/ Velvet. Wireless 10W. Anti-Slip.
Ladegerät Mauspad. Polyester 300D RPET/ Wildleder. Drahtlos 10W. Rutschfest.
Tapis Souris Chargeur. Polyester 300D RPET/ Suédine. Sans Fil 10W. Antidérapant.
Oplader Muispad. Polyester 300D RPET/ Fluweel. Draadloos 10W. Anti-Slip.

26.5 x 20.5 cm 50 Print Code: F(1), N(8)



Dropol 5946

Charger Mousepad. PU. Wireless 5W. Anti-Slip.
Ladegerät Mauspad. PU. Drahtlos 5W. Rutschfest.
Tapis Souris Chargeur. Similicuir. Sans Fil 5W. Antidérapant.
Oplader Muispad. PU. Draadloos 5W. Anti-Slip.

30 x 21 cm 25 Print Code: F(1), L2





Kaishen 1870

Mousepad. Cork/ Silicone. Padded Wrist Rest. Anti-Slip.
 Mauspad. Kork/ Silikon. Gepolsterte Palmrest. Rutschfest.
 Tapis Souris. Liège/ Silicone. Repose-Mains Rembourrée. Antidérapant.
 Muispad. Kurk/ Siliconen. Gewatteerd Polssteun. Anti-Slip.

20 x 22.3 cm 100 / 50 Print Code: E(1), L2, N(8)



Freila 1871

Mousepad. Polyester RPET/ Silicone. Padded Wrist Rest. Anti-Slip.
 Mauspad. Polyester RPET/ Silikon. Gepolsterte Palmrest. Rutschfest.
 Tapis Souris. Polyester RPET/ Silicone. Repose-Mains Rembourrée. Antidérapant.
 Muispad. Polyester RPET/ Siliconen. Gewatteerd Polssteun. Anti-Slip.

20 x 22.3 cm 100 / 50 Print Code: E(1), N(8)



Gong 9850

Mousepad. PU. Padded Wrist Rest. Anti-Slip.
 Mauspad. PU. Gepolsterte Palmrest. Rutschfest.
 Tapis Souris. Similicuir. Repose-Mains Rembourrée. Antidérapant.
 Muispad. PU. Gewatteerd Polssteun. Anti-Slip.

18.5 x 22.5 cm 50 / 25 Print Code: E(1), L2, T

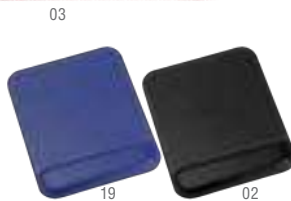

Minet 6140

Mousepad. Polyester/ Silicone. Padded Wrist Rest. Anti-Slip.
 Mauspad. Polyester/ Silikon. Gepolsterte Palmrest. Rutschfest.
 Tapis Souris. Polyester/ Silicone. Repose-Mains Rembourrée. Antidérapant.
 Muispad. Polyester/ Siliconen. Gewatteerd Polssteun. Anti-Slip.

20.5 x 24.3 cm 100 Print Code: E(1), N(8), R



Hanlax 1282

Mat. Cork. Anti-Slip.
Matte. Kork. Rutschfest.
Tapis. Liège. Antidérapant.
Mat. Kurk. Anti-Slip.

60 x 40 cm 100 Print Code: F(1), L2, N(8)

Natural Cork

Topick 1286

Mousepad. Cork/ Silicone. Anti-Slip.
Mauspad. Kork/ Silikon. Rutschfest.
Tapis Souris. Liège/ Silicone. Antidérapant.
Muispad. Kurk/ Siliconen. Anti-Slip.

Ø 20 cm 200 / 50 Print Code: E(1), L2, N(8)

Tonya 20151

Mousepad. Cork/ Silicone. Anti-Slip.
Mauspad. Kork/ Silikon. Rutschfest.
Tapis Souris. Liège/ Silicone. Antidérapant.
Muispad. Kurk/ Siliconen. Anti-Slip.

22 x 18 cm 200 / 50 Print Code: E(1), L2, N(8)

Sinjur 1866

Mousepad. Recycled Paper/ Silicone. Anti-Slip.
Mauspad. Recycling Papier/ Silikon. Rutschfest.
Tapis Souris. Papier Recyclé/ Silicone. Antidérapant.
Muispad. Gerecycled Papier/ Siliconen. Anti-Slip.

22 x 18 cm 200 / 50 Print Code: E(1), L2





03



Roland 5520

Mousepad. Polyester/ Silicone. Anti-Slip.
 Mauspad. Polyester/ Silikon. Rutschfest.
 Tapis Souris. Polyester/ Silicone. Antidérapant.
 Muispad. Polyester/ Siliconen. Anti-Slip.

📏 Ø 20 cm 📦 250 / 50 🗑️ Print Code: E(1), N(8), R



02

01

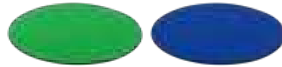

04

19



01



19

Vaniat 4387

Mousepad. Polyester/ Silicone. Anti-Slip.
 Mauspad. Polyester/ Silikon. Rutschfest.
 Tapis Souris. Polyester/ Silicone. Antidérapant.
 Muispad. Polyester/ Siliconen. Anti-Slip.

📏 22 x 18 cm 📦 250 / 50
 🗑️ Print Code: E(1), N(8), R



07

11

03

02

04

05



Lena 20216

Mousepad. Felt RPET/ Silicone. Anti-Slip.
 Mauspad. Filz RPET/ Silikon. Rutschfest.
 Tapis Souris. Feutrine RPET/ Silicone. Antidérapant.
 Muispad. Vilt RPET/ Siliconen. Anti-Slip.

📏 22 x 18 cm 📦 400 / 50 🗑️ Print Code: E(1), N(8)



Walin 6764



Antibacterial Mousepad. Polyester/ Silicone. Anti-Slip.
 Antibakteriell Mauspad. Polyester/ Silikon. Rutschfest.
 Tapis Souris Antibacterienne. Polyester/ Silicone. Antidérapant.
 Antibacterieel Muispad. Polyester/ Siliconen. Anti-Slip.

📏 22 x 18 cm 📦 250 / 50 🗑️ Print Code: E(1), N(8), R



Lautrec 20843 (15W) WIRELESS CHARGER

Organizer Charger. Bamboo. Wireless 15W. Felt Tip Pen and Eraser Included.

Ordner Ladegerät. Bambus. Drahtlos 15W. Filzstift und Radierer Inklusiv.

Chargeur Organiseur. Bambou. Sans Fil 15W. Feutre et Effaceur Inclusif.

Organizer Oplader. Bamboe. Draadloos 15W. Felt Tip Pen en Gum Inclusief.

📏 25.5 x 1.7 x 14 cm 📦 25 🗣️ Print Code: E(4), L2, W



Treit 20861 (15W) WIRELESS CHARGER

Organizer Charger. Bamboo. Wireless 15W.

Ordner Ladegerät. Bambus. Drahtlos 15W.

Chargeur Organiseur. Bambou. Sans Fil 15W.

Organizer Oplader. Bamboe. Draadloos 15W.

📏 17.3 x 1.2 x 8.7 cm 📦 100 / 25 🗣️ Print Code: E(4), L2, W

Loubron 1438 (15W) WIRELESS CHARGER

Organizer Charger. Bamboo. Wireless 15W. USB Output.

Ordner Ladegerät. Bambus. Drahtlos 15W. USB Ausgang.

Chargeur Organiseur. Bambou. Sans Fil 15W. Sortie USB.

Organizer Oplader. Bamboe. Draadloos 15W. USB Output.

📏 18.5 x 1.4 x 11.5 cm 📦 50 / 25 🗣️ Print Code: E(4), L2, W

Golbar 1439 (15W) WIRELESS CHARGER

Organizer Charger. Bamboo. Wireless 15W. USB Output.

Ordner Ladegerät. Bambus. Drahtlos 15W. USB Ausgang.

Chargeur Organiseur. Bambou. Sans Fil 15W. Sortie USB.

Organizer Oplader. Bamboe. Draadloos 15W. USB Output.

📏 25.5 x 1.4 x 13.5 cm 📦 50 / 25 🗣️ Print Code: E(4), L2, W





Macky 1958

Organizer Charger. Wireless 10W.
 Ordner Ladegerät. Drahtlos 10W.
 Chargeur Organiseur. Sans Fil 10W.
 Organizer Oplader. Draadloos 10W.

8.6 x 7 x 8.6 cm 40 / 20 Print Code: E(4)



Sainford 21059

(15W)
WIRELESS CHARGER

Multifunction Charger. Bamboo/ Metal. Wireless 15W. 50 Sticky Notes 4,5 x 4,5 cm. USB Output. Type C Output and Input.
 Multifunktion Ladegerät. Bambus/ Metall. Drahtlos 15W. 50 Haftnotizen 4,5 x 4,5 cm. USB Ausgang. Typ C Ausgänge und Eingang.
 Chargeur Multifonction. Bambou/ Métal. Sans Fil 15W. 50 Notes Adhésives 4,5 x 4,5 cm. Sortie USB. Sortie et Entrée Type C.
 Multifunctioneel Oplader. Bamboe/ Metaal. Draadloos 15W. 50 Plakmemo's 4,5 x 4,5 cm. USB Output. Typ C Output en Input.

16.1 x 8 x 7.5 cm 100 / 25 Print Code: E(1), L2



Taron 1868

Organizer Charger. Recycled Cardboard. Wireless 10W.
 Ordner Ladegerät. Recycling Pappe. Drahtlos 10W.
 Chargeur Organiseur. Carton Recyclé. Sans Fil 10W.
 Organizer Oplader. Gerecycled Karton. Draadloos 10W.

25 x 1.4 x 10 cm 50 / 25 Print Code: E(4), W

Beny 1968

(15W)
WIRELESS CHARGER

Organizer Charger. Cork/ Bamboo. Wireless 15W.
 Ordner Ladegerät. Kork/ Bambus. Drahtlos 15W.
 Chargeur Organiseur. Liège/ Bambou. Sans Fil 15W.
 Organizer Oplader. Kurk/ Bamboe. Draadloos 15W.

27 x 14 x 1.8 cm 50 / 25 Print Code: E(4), L2, W



Birwen 20269

Multifunction Pencil Holder. Wheat Straw/ ABS/ Bamboo. Suitable for data transfer. Wireless Charger 5W. 1 Hub Type C. 2 Hubs USB 2.0.
 Multifunktion Stifthalter. Weizenstroh/ ABS/ Bambus. Geeignet für die datenübertragung. Drahtlos Ladegerät 5W. 1 Typ C Hub. 2 Hubs USB 2.0.
 Porte-Crayons Multifonction. Paille de Blé/ ABS/ Bambou. Convient au transfert de données. Chargeur Sans Fil 5W. 1 Port Type C. 2 Ports USB 2.0.
 Multifunctioneel Pennenbakje. Tarwestro/ ABS/ Bamboe. Geschikt voor data-overdracht. Draadloos Oplader 5W. 1 Type C Poort. 2 Poorten USB 2.0.

📏 8.5 x 10.5 cm 📦 50 / 25 🖨️ Print Code: E(1), L2



Dowex 6709

Multifunction Pencil Holder. Wheat Straw/ ABS. Wireless Charger 5W. 3 Hubs. USB 2.0.
 Multifunktion Stifthalter. Weizenstroh/ ABS. Drahtlos Ladegerät 5W. 3 Hubs. USB 2.0.
 Porte-Crayons Multifonction. Paille de Blé/ ABS. Chargeur Sans Fil 5W. 3 Ports. USB 2.0.
 Multifunctioneel Pennenbakje. Tarwestro/ ABS. Draadloos Oplader 5W. 3 Poorten. USB 2.0.

📏 8.5 x 10 x 9 cm 📦 50 / 25 🖨️ Print Code: E(4), W



Bloxem 1139

Multifunction Pencil Holder. Bamboo. Wireless Charger 5W. 4 Hubs. USB 2.0.
 Multifunktion Stifthalter. Bambus. Drahtlos Ladegerät 5W. 4 Hubs. USB 2.0.
 Porte-Crayons Multifonction. Bambou. Chargeur Sans Fil 5W. 4 Ports. USB 2.0.
 Multifunctioneel Pennenbakje. Bamboe. Draadloos Oplader 5W. 4 Poorten. USB 2.0.

📏 6.8 x 12.1 x 11.5 cm 📦 20 🖨️ Print Code: E(4), L2



Sondur 6928

Multifunction Pencil Holder. Recycled Cardboard. Wireless Charger 5W. 2 Hubs. USB 2.0.
 Multifunktion Stifthalter. Recycling Pappe. Drahtlos Ladegerät 5W. 2 Hubs. USB 2.0.
 Porte-Crayons Multifonction. Carton Recyclé. Chargeur Sans Fil 5W. 2 Ports. USB 2.0.
 Multifunctioneel Pennenbakje. Gerecycled Karton. Draadloos Oplader 5W. 2 Poorten. USB 2.0.

📏 9 x 11 x 9.7 cm 📦 40 / 20 🖨️ Print Code: E(4)



Pekon 6737

Multifunction Pencil Holder. Wireless Charger 5W. 2 USB Outputs. 1 Hub USB 2.0.
 Multifunktion Stifthalter. Drahtlos Ladegerät 5W. 2 USB Ausgänge. 1 Hub USB 2.0.
 Porte-Crayons Multifonction. Chargeur Sans Fil 5W. 2 Sorties USB. 1 Port USB 2.0.
 Multifunctioneel Pennenbakje. Draadloos Oplader 5W. 2 USB Outputs. 1 Poorten USB 2.0.

8.8 x 9.8 x 8.9 cm 50 Print Code: E(4)



Belind 5964

USB Hub Pencil Holder. Led Lights. 2 Light Modes. 4 Hubs. USB 2.0.
 USB Hub Stifthalter. Led Lichter. 2 Lichtpositionen. 4 Hubs. USB 2.0.
 Porte-Crayons Port USB. Lumières Led. 2 Modes de Lumière. 4 Ports. USB 2.0.
 USB Hub Pennenbakje. Led Lichten. 2 Licht Posities. 4 Poorten. USB 2.0.

7 x 8 x 7 cm 100 / 50 Print Code: E(4)



Wicam 1225



Multifunction Pencil Holder. Cork. Button Batteries Included.
 Multifunktion Stifthalter. Kork. Knopzellen Inklusive.
 Porte-Crayons Multifonction. Liège. Piles Bouton Incluses.
 Multifunctioneel Pennenbakje. Kurk. Knooppcel Batterijen Inclusief.

8.2 x 9.8 x 8.3 cm 50 / 25 Print Code: E(1), L2



Petrox 6807



Multifunction Pencil Holder. Bamboo/ABS. Button Battery Included.
 Multifunktion Stifthalter. Bambou/ ABS. Knopzelle Inklusive.
 Porte-Crayons Multifonction. Bambou/ ABS. Pile Bouton Inclusive.
 Multifunctioneel Pennenbakje. Bamboe/ ABS. Knooppcel Batterij Inclusief.

10.2 x 11.9 x 5.4 cm 50 Print Code: E(4), L2





19

Tipel 4574

Pencil Holder. Metal.
Stifthalter. Metall.
Porte-Crayons. Métal.
Pennbakje. Metaal.

8 x 9.7 x 8 cm 100 / 25
Print Code: F(4), L1



02

05

09

03



08



19

Organic 2421

Pencil Holder.
Stifthalter.
Porte-Crayons.
Pennbakje.

7.2 x 13.8 x 9.1 cm 100 Print Code: D(4)



04



05



Prosan 1226

Pencil Holder. Cork.
Stifthalter. Kork.
Porte-Crayons Support. Liège.
Pennbakje Houder. Kurk.

6.5 x 13.2 x 8.5 cm 50 Print Code: E(4), L2

Davor 1018

Pencil Holder. Recycled Cardboard.
Stifthalter. Recycling Pappe.
Porte-Crayons. Carton Recyclé.
Pennbakje. Gerecycled Karton.

9 x 9 x 9 cm 500 / 100 Print Code: B(4)





Oswin 20239

Pencil Holder: Bamboo/ Metal.
Stifthalter: Bambus/ Metall.
Porte-Crayons: Bambou/ Métal.
Pennensbakje: Bamboe/ Metaal.

Print Code: E(4), L1



Furik 20926

Pencil Holder: Bamboo/ Metal.
Stifthalter: Bambus/ Metall.
Porte-Crayons Support: Bambou/ Métal.
Pennensbakje Houder: Bamboe/ Metaal.

Print Code: E(1), L1



Laorek 1875

Everlasting Calendar Pencil Holder: MDF.
Ewiger Kalender Stifthalter: MDF.
Porte-Crayons Calendrier Perpétuel: MDF.
Eeuwige Kalender Pennensbakje: MDF.

Print Code: E(4), L2



Firdex 1877

Pencil Holder: Bamboo/ Felt RPET.
Stifthalter: Bambus/ Filz RPET.
Porte-Crayons Support: Bambou/ Feutrine RPET.
Pennensbakje Houder: Bamboe/ Vilt RPET.

Print Code: E(4), L1





Kosinen 20914

Organizer. Bamboo.
 Ordner. Bambus.
 Organiseur. Bambou.
 Organizer. Bamboe.

8 x 3.7 x 8 cm 100 / 50 Print Code: D(1), L1

Heinda 1878

Notepad Holder. Bamboo. 80 Sticky Notes 5,5 x 8,2 cm.
 Halter Notizzettelbox. Bambus. 80 Haftnotizen 5,5 x 8,2 cm.
 Porte Notes Support. Bambou. 80 Notes Adhésives 5,5 x 8,2 cm.
 Houder Plakmemohouder. Bamboe. 80 Plakmemo's 5,5 x 8,2 cm.

11.8 x 1.9 x 7 cm 100 / 50 Print Code: D(4), L1

Inary 1882

Card Set. Wood. 10 Pieces.
 Karten Set. Holz. 10 Stück.
 Set Cartes. Bois. 10 Pièces.
 Kaart Set. Hout. 10 Stuks.

5.8 x 8.9 x 2 cm 250 / 50
 Print Code: A(4), C(1), L1, W



Brajil 1876

Organizer. Bamboo/ Felt RPET.
 Ordner. Bambus/ Filz RPET.
 Organiseur. Bambou/ Feutrine RPET.
 Organizer. Bamboe/ Vilt RPET.

20 x 2 x 10 cm 50 Print Code: E(4), L2

Glaston 1481

Pencil Case. Felt RPET/ Bamboo.
 Federmappe. Filz RPET/ Bambus.
 Trousse. Feutrine RPET/ Bamboe.
 Etui. Vilt RPET/ Bamboe.

19.8 x 6.3 x 5.6 cm 50 Print Code: F(1), L2



Dilaver 20376

Sharpener. Bamboo/ Wheat Straw/ ABS.
Anspitzer. Bambus/ Weizenstroh/ ABS.
Taille-Crayon. Bambou/ Paille de Blé/ ABS.
Potlood Slijper. Bamboe/ Tarwestro/ ABS.

📏 Ø 4.4 x 6.3 cm 📦 400 / 50 🖨️ Print Code: C(4), L1



Sediax 20925

Clip. Bamboo. Magnetic.
Klammer. Bambus. Magnetisch.
Pince. Bambou. Magnétique.
Knijper. Bamboe. Magnetisch.

📏 6 x 6 x 3.2 cm 📦 500 / 50 🖨️ Print Code: C(4), L1



Hunzu 21069

Stapler. Bamboo. 50 Staples Included.
Tacker. Bambus. 50 Klammern Inklusive.
Agrafese. Bamboe. 50 Agrafes Inklusief.
Nietmachine. Bamboe. 50 Nietjes Inbegrepen.

📏 7 x 4.5 x 2.1 cm 📦 150 / 50 🖨️ Print Code: C(4), L1



Sanny 1880

Clip. Wood.
Clip. Holz.
Clip. Bois.
Clip. Hout.

📏 2.5 x 11.2 x 2.5 cm 📦 800 / 200 🖨️ Print Code: C(4), L1



Forsen 1874

Clips Holder. Glass/ Cork. 15 Clips Included.
Büroklammernhalter. Glas/ Kork. 15 Büroklammern Inklusive.
Porte-Trombones. Verre/ Liège. 15 Clips Inklusief.
Paperclipschaaltje. Glas/ Kurk. 15 Clips Inclusief.

📏 Ø 5.6 x 7.6 cm 📦 50 🖨️ Print Code: C(4), L1



Rhydor 4812

Clips Holder. 100 Clips Included.
Büroklammernhalter. 100 Büroklammern Inklusive.
Porte-Trombones. 100 Clips Inklusief.
Paperclipschaaltje. 100 Clips Inclusief.

📏 5.1 x 7.5 x 6.9 cm 📦 200 / 20 🖨️ Print Code: C(1)



Andrus 20919

Clips Holder. Wheat Straw/ ABS. 50 Clips Included.
Büroklammernhalter. Weizenstroh/ ABS. 50 Büroklammern Inklusive.
Porte-Trombones. Paille de Blé/ ABS. 50 Clips Inklusief.
Paperclipschaaltje. Tarwestro/ ABS. 50 Clips Inclusief.

📏 5.3 x 2 x 5.3 cm 📦 400 / 100 🖨️ Print Code: C(4), W





New

Bernaye 20971

Seeds Bookmark. Recycled Cardboard. Sunflower Seeds Included.
Samen Lesezeichen. Recycling Pappe. Sonnenblumesamen Inklusief.
Marque Pages Ensemencé. Carton Recyclé. Graines de Tournesol Inclusief.
Zaad Bladwijzer. Gerecycled Karton. Zonnebloem Zaden Inclusief.

5.5 x 15 x 0.2 cm 400 / 100 Print Code: B(4)



Momo 1881

Bookmark. Bamboe.
Lesezeichen. Bambus.
Marque Pages. Bamboe.
Bladwijzer. Bamboe.

4 x 13 x 0.2 cm 1000 / 200 Print Code: C(4), L1



New

Loiza 20918

Ruler Bookmark. Wheat Straw/ ABS. 10 cm.
Lineal Lesezeichen. Weizenstroh/ ABS. 10 cm.
Règle Marque Pages. Paille de Blé/ ABS. 10 cm.
Liniaal Bladwijzer. Tarwestro/ ABS. 10 cm.

13 x 2.5 x 0.4 cm 500 / 100 Print Code: B(4)



Jofry 1670

Bookmark. Recycled Cardboard. Magnetic.
Lesezeichen. Recycling Pappe. Magnetisch.
Marque Pages. Carton Recyclé. Magnétique.
Bladwijzer. Gerecycled Karton. Magnetisch.

2 x 6 x 0.2 cm 2000 / 500 Print Code: C(4)

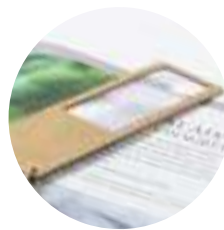

Kigan 1669

Magnifier Bookmark. Recycled Cardboard.
Loupe Lesezeichen. Recycling Pappe.
Loupe Marque Pages. Carton Recyclé.
Vergrootglas Bladwijzer. Gerecycled Karton.

13.9 x 3.7 x 0.1 cm 2500 / 500
Print Code: C(4)



Lektura 3585

Lamp. 1 Led. Flexibel. Button Batterijen Inklusief.
Lampe. 1 Led. Flexibel. Knopfzellen Inklusief.
Lampe. 1 Led. Flexibel. Piles Bouton Inclusief.
Lamp. 1 Led. Flexibel. Knopcel Batterijen Inclusief.

3 x 25 x 2 cm 200 / 50 Print Code: E(1)

RULER

Thirty 9774

Scale Ruler. Aluminium. 30 cm. Scales: 1:20, 1:25, 1:50, 1:75, 1:100.
 Maßstab. Aluminium. 30 cm. Skala: 1:20, 1:25, 1:50, 1:75, 1:100.
 Règle. Aluminium. 30 cm. Échelle: 1:20, 1:25, 1:50, 1:75, 1:100.
 Lineaal. Aluminium. 30 cm. Schaal: 1:20, 1:25, 1:50, 1:75, 1:100.

 32 x 2 x 2 cm  200 / 20  Print Code: F(4), L1

Nixora 20379

Ruler. Wheat Straw/ ABS. 30 cm.
 Lineal. Weizenstroh/ ABS. 30 cm.
 Règle. Paille de Blé/ ABS. 30 cm.
 Lineaal. Tarwestro/ ABS. 30 cm.

 30.7 x 4 x 0.3 cm  500 / 100  Print Code: D(1), W



Arnax 20378

Ruler. Wood. 30 cm.
 Lineal. Holz. 30 cm.
 Règle. Bois. 30 cm.
 Lineaal. Hout. 30 cm.

 31 x 2.5 x 0.3 cm  500 / 100  Print Code: D(1), L2, W



Nitria 6679

Antibacterial Ruler. 30 cm and 12".
 Antibakteriell Lineal. 30 cm und 12".
 Règle Antibacterienne. 30 cm et 12".
 Antibacterieel Lineaal. 30 cm en 12".

 31.5 x 4 x 0.2 cm  500 / 100  Print Code: D(1), L2, W



Highlighter



Rankap 4898



Highlighter.
Textmarker.
Surligneur.
Marker.

2.3 x 6 x 1.4 cm 2000 / 50 Print Code: B(4)

Layax 5024



Highlighter Set. 5 Pieces.
Textmarker Set. 5 Stück.
Set Surligneurs. 5 Pièces.
Markers Set. 5 Stuks.

5.7 x 7.8 x 7.4 cm 200 / 20 Print Code: C(1), B(4)



Dinku 6209



Highlighter Set. 5 Pieces.
Textmarker Set. 5 Stück.
Set Surligneurs. 5 Pièces.
Markers Set. 5 Stuks.

10.8 x 8.7 x 1.8 cm 250 / 50 Print Code: C(4), W



Trico 3201



Highlighter. 3 Ink Colours.
Textmarker. 3 Farben Tinte.
Surligneur. Écriture 3 Couleurs.
Marker. 3 Kleuren Inkt.

9 x 8 x 1.2 cm 500 / 50 Print Code: C(4), W



Hindal 6404



Highlighter Set. 5 Ink Colours.
Textmarker Set. 5 Farben Tinte.
Set Surligneurs. Écriture 5 Couleurs.
Markers Set. 5 Kleuren Inkt.

Ø 9.8 x 1.8 cm 250 / 50 Print Code: C(4), W



Highlighter



Shimo 20290

Highlighter. Wheat Straw/ ABS.
Textmarker. Weizenstroh/ ABS.
Surligneurs. Paille de Blé/ ABS.
Markers. Tarwestro/ ABS.

2.6 x 6.7 x 1.5 cm 1000 / 100 Print Code: B(4)



Pentar 20924

Highlighter Set. Wheat Straw/ ABS. 5 Pieces.
Textmarker Set. Weizenstroh/ ABS. 5 Stück.
Set Surligneurs. Paille de Blé/ ABS. 5 Pièces.
Markers Set. Tarwestro/ ABS. 5 Stuks.

9.7 x 9.7 x 1.3 cm 200 / 50 Print Code: C(4), W



Rpet



Conrad 1287

Highlighter. RPET.
Textmarker. RPET.
Surligneur. RPET.
Marker. RPET.

2.6 x 11.8 x 1.4 cm 500 / 50 Print Code: B(4)



Toaren 20289

Highlighter Set. Wheat Straw/ ABS. 3 Pieces.
Textmarker Set. Weizenstroh/ ABS. 3 Stück.
Set Surligneurs. Paille de Blé/ ABS. 3 Pièces.
Markers Set. Tarwestro/ ABS. 3 Stuks.



5.7 x 7.8 x 7.6 cm 200 / 100 Print Code: C(1), B(4)





Gadner 6907

Everlasting Calendar. Recycled Cardboard.
Ewiger Kalender. Recycling Pappe.
Calendrier Perpétuel. Carton Recyclé.
Eeuwige Kalender. Gerecycled Karton.

 15 x 7 x 4 cm  500 / 100  Print Code: E(1)



Vitelix 1262



Everlasting Calendar. Bamboo.
Ewiger Kalender. Bambus.
Calendrier Perpétuel. Bambou.
Eeuwige Kalender. Bamboe.

 20 x 12 x 9 cm  30  Print Code: D(1), L1



Lider 3424

Everlasting Calendar.
Ewiger Kalender.
Calendrier Perpétuel.
Eeuwige Kalender.

 14 x 9 x 4 cm  300 / 50  Print Code: D(2)



03

Myd 9574

Calculator: 8 Digits. Button Battery Included.
 Taschenrechner: 8 Ziffern. Knopfzelle Inklusive.
 Calculatrice: 8 Chiffres. Pile Bouton Incluse.
 Rekenmachine: 8 Cijfers. Knopcel Batterij Inclusief.

10.5 x 16.5 x 3.5 cm

50 / 25

Print Code: D(4)



07

19



Tueris 1883

Calculator: Aluminium. Solar. 12 Digits. Button Battery Included.
 Taschenrechner: Aluminium. Solar. 12 Ziffern. Knopfzelle Inklusive.
 Calculatrice: Aluminium. Solaire. 12 Chiffres. Pile Bouton Incluse.
 Rekenmachine: Aluminium. Zonne-energie. 12 Cijfers. Knopcel Batterij Inclusief.

15.4 x 12 x 2.5 cm

60 / 30

Print Code: D(1), L1



Vulcano 1867

Calculator: Recycled Cardboard. Solar. 8 Digits.
 Taschenrechner: Recycling Pappe. Solar. 8 Ziffern.
 Calculatrice: Carton Recyclé. Solaire. 8 Chiffres.
 Rekenmachine: Gerecycled Karton. Zonne-energie. 8 Cijfers.

10.4 x 16 x 0.4 cm

200 / 50

Print Code: D(4)



New

Seste 21070

Calculator: Cork. Solar. 10 Digits. Button Battery Included.
 Taschenrechner: Kork. Solar. 10 Ziffern. Knopfzelle Inklusive.
 Calculatrice: Liège. Solaire. 10 Chiffres. Pile Bouton Incluse.
 Rekenmachine: Kurk. Zonne-energie. 10 Cijfers. Knopcel Batterij Inclusief.

9.5 x 17 x 1.4 cm

100 / 50

Print Code: D(4), L1



Sitax 21224

Calculator: Bamboo/ ABS. Solar. 8 Digits. Button Battery Included.
 Taschenrechner: Bambus/ ABS. Solar. 8 Ziffern. Knopfzelle Inklusive.
 Calculatrice: Bambou/ ABS. Solaire. 8 Chiffres. Pile Bouton Incluse.
 Rekenmachine: Bamboe/ ABS. Zonne-energie. 8 Cijfers. Knopcel Batterij Inclusief.

6.5 x 12.4 x 1.1 cm

200 / 50

Print Code: D(4), L1

Ligrant 1200

Cup Warmer. Bamboo. USB Connection.
Tasse Wärmer. Bambus. USB Anschluss.
Chauffe Tasses. Bambou. Connexion USB.
Warmhoudplaatje. Bamboe. USB Verbinding.

☰ Ø 10.4 x 1.9 cm 📦 100 / 25 🖨️ Print Code: D(4)



Nodens 1873

Charger Cup Warmer. Bamboo. Wireless 10W. USB Connection.
Tasse Wärmer Ladegerät. Bambus. Drahtlos 10W. Anschluss USB.
Chauffe Tasses Chargeur. Bambou. Sans Fil 10W. Connexion USB.
Warmhoudplaatje Oplader. Bamboe. Draadloos 10W. USB Connectie.

☰ 18.2 x 1.3 x 9.7 cm 📦 50 🖨️ Print Code: E(4), L2, W

Mug 9528

Cup Warmer. USB Connection.
Tasse Wärmer. USB Anschluss.
Chauffe Tasses. Connexion USB.
Warmhoudplaatje. USB Verbinding.

☰ Ø 10 x 2.1 cm 📦 100 / 25
🖨️ Print Code: D(4)



03



01

09

11

19



350 ml



Kalan 6533 ^(15W) WIRELESS CHARGER

Charger Cup Warmer. Ceramic/ ABS. 350 ml. Wireless 15W. USB Connection.
Tasse Wärmer Ladegerät. Keramik/ ABS. 350 ml. Drahtlos 15W. Anschluss USB.
Chauffe Tasses Chargeur. Céramique/ ABS. 350 ml. Sans Fil 15W. Connexion USB.
Warmhoudplaatje Oplader. Keramiek/ ABS. 350 ml. Draadloos 15W. USB Connectie.

☰ 11 x 12.5 x 11 cm 📦 20 🖨️ Print Code: G(4), L2

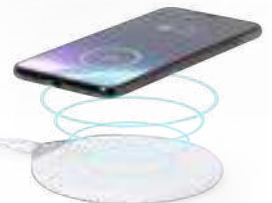



Durden 20869

Mini Heater. 600W. AC 220-240V.
 Mini Heizung. 600W. AC 220-240V.
 Mini Chauffage. 600W. AC 220-240V.
 Mini Verwarmer. 600W. AC 220-240V.

13.5 x 13.5 x 11.5 cm 20 Print Code: G(1)



JaneK 20868

Mini Air Conditioner. 700 ml. 3 Modes. USB Connection.
 Mini Klimaanlage. 700 ml. 3 Positionen. USB Anschluss.
 Mini Climatiseur. 700 ml. 3 Modes. Connexion USB.
 Mini Airconditioner. 700 ml. 3 Posities. USB Verbinding.

16 x 16 x 17 cm 12 Print Code: G(1)



01



19

05

11

Miclox 4389

Mini Fan. USB Connection.
 Mini Ventilator. USB Anschluss.
 Mini Ventilateur. Connexion USB.
 Mini Ventilator. USB Verbinding.

14.9 x 14 x 9.5 cm 40
 Print Code: E(1)



03



New

Fanger 20765

Holder Fan. 3 Modes. Battery 300 mAh.
 Halter Ventilator. 3 Positionen. Batterie 300 mAh.
 Ventilateur Support. 3 Modes. Batterie 300 mAh.
 Houder Ventilator. 3 Posities. Batterij 300 mAh.

7.8 x 13.2 x 2.8 cm 100/50
 Print Code: E(4)



New



Benard 20766

FAn. Foldable. 3 Modes. Battery 400 mAh.
 Ventilator. Falibar. 3 Positionen. Batterie 400 mAh.
 Ventilateur. Pliable. 3 Modes. Batterie 400 mAh.
 Ventilator. Opvouwbaar. 3 Posities. Batterij 400 mAh.

8 x 14.2 x 2.5 cm 50 Print Code: E(4)



New



Heroux 21225

MICRO SD
USB ▶
USB PLAYER

WIFI & HDMI

Projector: 720P, Wifi, Bluetooth Connection, Sound Power 5W, 7000 Lumens, AC 220-240V.
Projektör: 720P, Wifi, Bluetooth Anschluss, Schallleistung 5W, 7000 Lumen, AC 220-240V.
Projecteur: 720P, Wifi, Connexion Bluetooth, Puissance Sonore 5W, 7000 Lumens, AC 220-240V.
Projector: 720P, Wifi, Bluetooth Verbindung, Geluidsvermogen 5W, 7000 Lumens, AC 220-240V.

22.1 x 8.6 x 16.8 cm 4 Print Code: K(1)



WHEAT STRAW

New



Lesi 20878

Presenter Laser Pointer: Wheat Straw/ ABS, Wireless, USB Connection, 1 Battery AAA/ R03 Included.
Präsentator Laser Pointer: Weizenstroh/ ABS, Optisch, USB Anschluss, 1 AAA/ R03 Batterie Inklusive.
Pointeur Laser Présentateur: Paille de Blé/ ABS, Optique, Connexion USB, 1 Pile AAA/ R03 Incluse.
Presenter Laser Pointer: Tarwestro/ ABS, Optical, USB Verbindung, 1 Batterij AAA/ R03 Inclusief.

2.5 x 14 x 1.4 cm 50 Print Code: C(4)



Haslam 5202

Presenter Laser Pointer: Wireless, USB Connection, 1 Battery AAA/ R03 Included.
Präsentator Laser Pointer: Optisch, USB Anschluss, 1 AAA/ R03 Batterie Inklusive.
Pointeur Laser Présentateur: Optique, Connexion USB, 1 Pile AAA/ R03 Incluse.
Presenter Laser Pointer: Optical, USB Verbindung, 1 Batterij AAA/ R03 Inclusief.

1.7 x 13.9 x 1.5 cm 50 Print Code: D(4), W



Snarry 4654

Laser Pen, Metal, 1 Led, Button Batteries Included.
Kugelschreiber Laser: Metall, 1 Led, Knopfzellen Inklusive.
Stylo Laser: Métal, 1 Led, Piles Bouton Incluses.
Laser Pen, Metaal, 1 Led, Knopcel Batterijen Inclusief.

Ø 1 x 12.3 cm 100/20 Print Code: D(4), L1, W

Decolf 1952

Presenter Laser Pointer: Wireless, USB Connection, 2 Battery AAA/ R03 Included.
Präsentator Laser Pointer: Optisch, USB Anschluss, 2 AAA/ R03 Batterien Inklusive.
Pointeur Laser Présentateur: Optique, Connexion USB, 2 Piles AAA/ R03 Incluses.
Presenter Laser Pointer: Optical, USB Verbindung, 2 Batterijen AAA/ R03 Inclusief.

3.2 x 12.2 x 2.4 cm 100/25 Print Code: D(4)



Fobis 1855



Laptop Pouch. Soft Shell.
Laptop-Tasche. Soft Shell.
Housse pour Ordinateur Portable. Soft Shell.
Laptoptasje. Soft Shell.

34 x 24 x 3 cm 40 Print Code: G(1), N(8)



Jobik 1856



Laptop Pouch. Soft Shell.
Laptop-Tasche. Soft Shell.
Housse pour Ordinateur Portable. Soft Shell.
Laptoptasje. Soft Shell.

39 x 26.5 x 3.5 cm 40 Print Code: G(1), N(8)



New



Garlan 20923

Tablet Pouch. Soft Shell.
Tablet-Tasche. Soft Shell.
Housse pour Tablet. Soft Shell.
Tablettasje. Soft Shell.

20 x 28 x 0.5 cm 200 / 20 Print Code: G(1), N(8)



New



Brunap 20922

Laptop Pouch. Soft Shell.
Laptop-Tasche. Soft Shell.
Housse pour Ordinateur Portable. Soft Shell.
Laptoptasje. Soft Shell.

27.7 x 39.5 x 0.5 cm 100 / 20 Print Code: G(1), N(8)



02



Xenac 4371

Laptop Pouch. Soft Shell.
Laptop-Tasche. Soft Shell.
Housse pour Ordinateur Portable. Soft Shell.
Laptoptasje. Soft Shell.

38 x 27 x 3 cm 40 Print Code: G(1), N(8)



RECYCLED
COTTON

RPET



02

New

Albarn 20927

Laptop Pouch. 100% Recycled Cotton. Padded.
Laptop-Tasche. 100% Recycling Baumwolle.
Gepolstert.

Housse pour Ordinateur Portable. 100% Coton
Recyclé. Rembourré.

Laptoptasje. 100% Gerecycled Katoen. Gewatteerd.



08

06

38 x 26 x 2 cm

100 / 50

Print Code: G(1), N(8), O



02

Krayon 6911

Laptop Pouch. Polyester 300D RPET. Padded.
Laptop-Tasche. Polyester 300D RPET. Gepolstert.
Housse pour Ordinateur Portable. Polyester 300D RPET. Rembourré.
Laptoptasje. Polyester 300D RPET. Gewatteerd.



08

06

39.5 x 29 x 3.5 cm

30

Print Code: N(8)

**Broomer 1468**

Multifunction Laptop Pouch. Polyester 600D RPET.
Multifunktion Laptop-Tasche. Polyester 600D RPET.
Housse pour Ordinateur Multifonction. Polyester 600D RPET.
Multifunctioneel Laptoptasje. Polyester 600D RPET.

39 x 28.5 x 0.9 cm

20

Print Code: N(8)

**Dilon 7364**

Laptop Pouch. Polyester 600D. Padded. Padded Laptop Compartment.
Laptop-Tasche. Polyester 600D. Gepolstert. Gepolsterte Laptoptasche.
Housse pour Ordinateur Portable. Polyester 600D. Rembourré. Pochette Rembourrée pour Portable.
Laptoptasje. Polyester 600D. Gewatteerd. Gewatteerd Laptop Compartment.

39.5 x 25 x 3.5 cm

30

Print Code: N(8)



ANTONIO MIRO

-RECYCLED- LEATHER



06

Kroll 1853



Laptop Pouch. Recycled Leather. Padded.
Laptop-Tasche. Recycling Leder. Gepolstert.
Housse pour Ordinateur Portable. Cuir Recyclé. Rembourré.
Laptoptasje. Gerecycled Leer. Gewatteerd.

36 x 25 cm 50 Print Code: G(1), L2



18



08

Hops 6847



Laptop Pouch. Polyester 600D RPET. Padded.
Laptop-Tasche. Polyester 600D RPET. Gepolstert.
Housse pour Ordinateur Portable. Polyester 600D RPET. Rembourré.
Laptoptasje. Polyester 600D RPET. Gewatteerd.

36 x 26 x 4.5 cm 100 Print Code: G(1), N(8)



06

Rpet
OFFICE & BUSINESS

NEW
COLOR

CORK



Leyli 1851



Laptop Pouch. Cork.
Laptop-Tasche. Kork.
Housse pour Ordinateur Portable. Liège.
Laptoptasje. Kurk.

37 x 26 cm 50 Print Code: G(1), N(8)



RECYCLED COTTON



19

Drift 1449

Laptop Pouch. 100% Recycled Cotton. Padded.
Laptop-Tasche. 100% Recycling Baumwolle. Gepolstert.
Housse pour Ordinateur Portable. 100% Coton Recyclé. Rembourré.
Laptoptasje. 100% Gerecycled Katoen. Gewatteerd.

39.5 x 26 x 3.5 cm 100 / 50
Print Code: G(1), N(8), O



03

13

02



New



SUBLIMATION



Lury 20741

Sublimation Laptop Pouch. Soft Shell.
 Sublimations Laptop-Tasche. Soft Shell.
 Housse pour Ordinateur Portable Sublimation. Soft Shell.
 Sublimatie Laptotasje. Soft Shell.

41 x 30 cm 50 / 10
 Print Code: R



Leduc 1854

Laptop Pouch. Canvas.
 Laptop-Tasche. Canvas.
 Housse pour Ordinateur Portable. Toile.
 Laptotasje. Canvas.

36 x 27 x 2 cm 50 Print Code: G(1)



Tronser 6944

Holder Organizer. Polyester/ PU.
 Halter Ordner. Polyester/ PU.
 Organiseur Support. Polyester/ Simlicuir.
 Organizer Houder. Polyester/ PU.

30.5 x 22.2 x 0.7 cm 40 / 20 Print Code: F(1), N(8)



Novac 1130



Laptop Pouch. Felt RPET.
Laptop-Tasche. Filz RPET.
Housse pour Ordinateur Portable. Feutrine RPET.
Laptotasje. Vilt RPET.



 37 x 26 cm  100 / 50  Print Code: G(1), N(8)



Ginax 20934



Laptop Pouch. Felt RPET.
Laptop-Tasche. Filz RPET.
Housse pour Ordinateur Portable. Feutrine RPET.
Laptotasje. Vilt RPET.

 39 x 28 cm  50  Print Code: G(1), N(8)



Brack 1849



Laptop Pouch. Felt RPET/ PU.
Laptop-Tasche. Filz RPET/ PU.
Housse pour Ordinateur Portable. Feutrine RPET/ Similicuir.
Laptotasje. Vilt RPET/ PU.

 37 x 26.5 x 2 cm  50  Print Code: G(1), N(8)

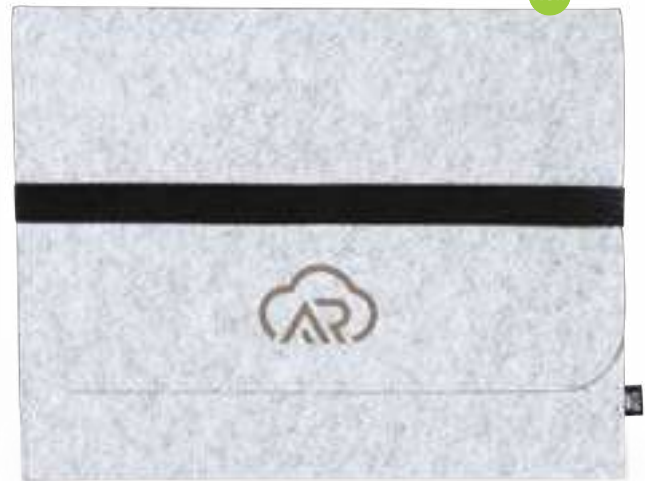

Riley 20215



Laptop Pouch. Felt RPET.
Laptop-Tasche. Filz RPET.
Housse pour Ordinateur Portable. Feutrine RPET.
Laptotasje. Vilt RPET.

 41 x 30 cm  100  Print Code: G(1), N(8)



20 Sheets
Lined

Ohara 20917

Folder. Cork. 20 Sheets Notepad.
Mappe. Kork. 20 Blätter Notizblock.
Porte-Documents. Liège. Bloc 20
Feuilles.
Map. Kurk. 20 Blaadjes Notepad.

25 x 31 x 2 cm 20
 Print Code: F(1), L2, N(8)



Hendrus 1888

Folder. Cork/ Linnen.
Mappe. Kork/ Leinen.
Porte-Documents. Liège/ Lin.
Map. Kurk/ Linnen.

24.5 x 32.5 x 1 cm 50 Print Code: F(1), L2, N(8)



Reymon 1863

Organizer. Wheat Straw/ ABS.
Ordner. Weizenstroh/ ABS.
Organiseur. Paille de Blé/ ABS.
Organizer. Tarwestro/ ABS.

22.5 x 32 x 1.7 cm 50 / 25 Print Code: F(1)



Holisk 6613

Organizer. MDF.
Ordner. MDF.
Organiseur. MDF.
Organizer. MDF.

22.5 x 32 x 1.1 cm 50 / 25 Print Code: F(1), L2



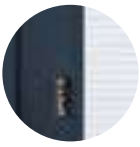

02



08



20 Sheets
Lined



06

NEW
COLOR



02



06



08

Linnoa 20932

Folder. Polyester 600D RPET. 20 Sheets Notepad.
Mappe. Polyester 600D RPET. 20 Blätter Notizblock.
Porte-Documents. Polyester 600D RPET. Bloc 20 Feuilles.
Map. Polyester 600D RPET. 20 Blaadjes Notepad.

23.5 x 31 x 2 cm 20
Print Code: F(1), N(8)



Sorgax 6844

Folder. Polyester 600D RPET. 20 Sheets Notepad.
Mappe. Polyester 600D RPET. 20 Blätter Notizblock.
Porte-Documents. Polyester 600D RPET. Bloc 20 Feuilles.
Map. Polyester 600D RPET. 20 Blaadjes Notepad.

24.5 x 32 x 1.5 cm 20
Print Code: F(1), L2, N(8)



20 Sheets
Lined



02

06

Neseby 1467

Folder. Polyester 600D RPET. 20 Sheets Notepad.
Mappe. Polyester 600D RPET. 20 Blätter Notizblock.
Porte-Documents. Polyester 600D RPET. Bloc 20 Feuilles.
Map. Polyester 600D RPET. 20 Blaadjes Notepad.

24.5 x 31.5 x 2 cm 10
Print Code: F(1), N(8)



08



20 Sheets
Lined



Haborg 5629

Folder. Recycled Cardboard.
Mappe. Recycling Papper.
Porte-Documents. Carton Recyclé.
Map. Gerecycled Karton.

23.5 x 31 cm 50 Print Code: F(1)



Damany 5630

Document Bag. Recycled Cardboard.
Dokumententasche. Recycling Papper.
Porte-Documents. Carton Recyclé.
Aktentas. Gerecycled Karton.

32.6 x 24.5 x 2 cm 50 Print Code: F(1)

Recycled Cardboard



20 Sheets
Lined

Vimaz 3639

Folder. Recycled Cardboard. 20 Sheets Notepad.
Mappe. Recycling Papper. 20 Blätter Notizblock.
Porte-Documents. Carton Recyclé. Bloc 20 Feuilles.
Map. Gerecycled Karton. 20 Blaadjes Notepad.

24.5 x 32 x 1 cm 50 / 25 Print Code: F(1)



Ecosum 2420

Folder. Recycled Cardboard.
Mappe. Recycling Papper.
Porte-Documents. Carton Recyclé.
Map. Gerecycled Karton.

25 x 34 x 1 cm 60 Print Code: F(1)



Quixar 21135

Folder, Wheat Straw/ PP.
Mappe, Weizenstroh/ PP.
Porte-Documents, Paille de Blé/ PP.
Map, Tarwestro/ PP.

24 x 31.5 x 0.5 cm 100 Print Code: F(1)

WHEAT STRAW



Hakala 20969

Seeds Folder, Recycled Cardboard.
Wildflowers.
Samen Mappe, Recycling Pappe, Wilde Blumen.
Porte-Documents Ensemencé, Carton Recyclé, Fleurs Sauvages.
Zaad Map, Gerecycled Karton, Wilde Bloemen.

22 x 30 x 0.5 cm 50 Print Code: F(1)



Bloguer 5628

Folder, Recycled Cardboard, 20 Sheets Notepad, Recycled Cardboard Pen Included.
Mappe, Recycling Pappe, 20 Blätter Notizblock, Recycling Pappe Kugelschreiber Inklusiv.
Porte-Documents, Carton Recyclé, Bloc 20 Feuilles, Stylo Carton Recyclé Inclusive.
Map, Gerecycled Karton, 20 Blaadjes Notepad, Pen Gerecycled Karton Inclusief.

23 x 32 x 1.5 cm 50 Print Code: F(1), B(1)



Kelem 3640

Folder, Recycled Cardboard, 20 Sheets Notepad, 25 Sticky Notes 7,4 x 7,4 cm, 125 Mini Sticky Notes 1,5 x 7,5 cm, Recycled Cardboard Pen Included.
Mappe, Recycling Pappe, 20 Blätter Notizblock, 25 Haftnotizen 7,4 x 7,4 cm, 125 Mini Haftnotizen 1,5 x 7,5 cm, Recycling Pappe Kugelschreiber Inklusiv.
Porte-Documents, Carton Recyclé, Bloc 20 Feuilles, 25 Notes Adhésives 7,4 x 7,4 cm, 125 Mini Notes Adhésives 1,5 x 7,5 cm, Stylo Carton Recyclé Inclusive.
Map, Gerecycled Karton, 20 Blaadjes Notepad, 25 Plakmemo's 7,4 x 7,4 cm, 125 Mini Plakmemo's 1,5 x 7,5 cm, Pen Gerecycled Karton Inclusief.

28.5 x 34.5 x 2.3 cm 50 / 25 Print Code: F(1), B(1)



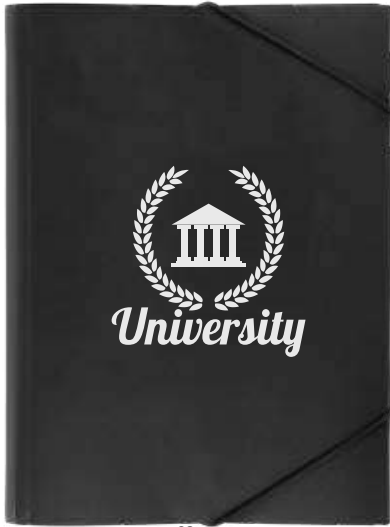

02



03



04

30 Sheets
Lined

Alpin 3157

Folder. PP.
Mappe. PP.
Porte-Documents. PP.
Map. PP.

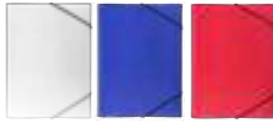

01

19

03

24 × 31.5 × 0.5 cm
Print Code: F(1)

100 / 25

Clasor 3774

Folder. PVC.
Mappe. PVC.
Porte-Documents. PVC.
Map. PVC.



01

02

23 × 31.5 × 0.5 cm
Print Code: F(1)

50



19

Columbya 3519

Folder. PP. 30 Sheets Notepad.
Mappe. PP. 30 Blätter Notzblock.
Porte-Documents. PP. Bloc 30 Feuilles.
Map. PP. 30 Blaadjes Notepad.



19

03

02

24 × 31 × 1 cm
Print Code: F(1)

50 / 10



03



19

Alice 3871

Document Holder. PP.
Dokumententasche. PP.
Porte-Documents. PP.
Aktentas. PP.



19

01

02

83 × 24 cm
Print Code: F(1)

200 / 50

Join 9751

Document Bag. Polyester 600D.
Dokumententasche. Polyester 600D.
Porte-Documents. Polyester 600D.
Aktentas. Polyester 600D.



13

07

06

04

11

03

02

38 × 32 cm
Print Code: F(1), N(8)

100 / 20



19

Mokai 3205

Folder. Microfibre/ Polyester. 20 Sheets Notepad.
 Mappe. Mikrofaser/ Polyester. 20 Blätter Notizblock.
 Porte-Documents. Microfibre/ Polyester. Bloc 20 Feuilles.
 Map. Microfibre/ Polyester. 20 Blaadjes Notepad.

25.3 x 31.5 x 1.3 cm 25
 Print Code: F(1), N(8)



02

03



02

Neco 9587

Folder. Polyester/ Microfibre. 20 Sheets Notepad.
 Mappe. Polyester/ Mikrofaser. 20 Blätter Notizblock.
 Porte-Documents. Polyester/ Microfibre. Bloc 20 Feuilles.
 Map. Polyester/ Microfibre. 20 Blaadjes Notepad.

24.5 x 32 x 1.5 cm 20
 Print Code: F(1), L2, N(8)



08

03

19



Index 3526

Folder. Microfibre. 20 Sheets Notepad.
 Mappe. Mikrofaser. 20 Blätter Notizblock.
 Porte-Documents. Microfibre. Bloc 20 Feuilles.
 Map. Microfibre. 20 Blaadjes Notepad.

24.5 x 32.5 x 2 cm 20
 Print Code: F(1), L2, N(8)



20 Sheets Lined



Bretux 4869

Folder. PU/ Polyester. 20 Sheets Notepad.
 Mappe. PU/ Polyester. 20 Blätter Notizblock.
 Porte-Documents. Similicuir/ Polyester. Bloc 20 Feuilles.
 Map. PU/ Polyester. 20 Blaadjes Notepad.

24 x 31 x 2 cm 20
 Print Code: F(1), L2, N(8)



20 Sheets Lined

New



15"
LAPTOP
COMPARTMENT

Rickey 20933

Document Bag. Felt RPET.
Dokumententasche. Filz RPET.
Porte-Documents. Feutrine RPET.
Aktentas. Vilt RPET.

38 x 28 x 8.5 cm 50 Print Code: G(1), N(8)



Avone 1850

Document Bag. Felt RPET/ PU.
Dokumententasche. Filz RPET/ PU.
Porte-Documents. Feutrine RPET/ Similicuir.
Aktentas. Vilt RPET/ PU.

37 x 30 x 3 cm 50/25 Print Code: G(1), N(8)



Tanil 1132

Document Bag. Felt RPET.
Dokumententasche. Filz RPET.
Porte-Documents. Feutrine RPET.
Aktentasas. Vilt RPET.

37 x 29 x 3 cm 30 Print Code: G(1), N(8)



Murray 1043



Holder Document Bag. Polyester 300D RPET. Padded. Padded Laptop Compartment.
 Halter Dokumententasche. Polyester 300D RPET. Gepolstert. Gepolsterte Laptoptasche.
 Porte-Documents Support. Polyester 300D RPET. Rembourré. Pochette Rembourrée pour Portable.
 Houder Aktentas. Polyester 300D RPET. Gewatteerd. Gewatteerd Laptop Compartment.

37 x 27 x 3.5 cm 30 Print Code: G(1), N(8)



New

Makarzur 21046

Document Bag Backpack. Polyester 600D RPET. Padded Laptop Compartment. Padded Back and Shoulder Straps.
 Dokumententasche Rucksack. Polyester 600D RPET. Gepolsterte Laptoptasche. Gepolsterter Rücken und Schultergurte.

Sac à Dos Porte-Documents. Polyester 600D RPET. Pochette Rembourrée pour Portable. Dos et Bretelles Rembourrées.

Aktentas Rugzak. Polyester 600D RPET. Gewatteerd Laptop Compartment. Gewatteerde Achterzijde en Schouderbanden.

28 x 40.5 x 13 cm 10 Print Code: I(8)



08



15" LAPTOP COMPARTMENT

RPET



Lourdel 1839

Shoulder Bag. Polyester 600D RPET. Padded.
 Umhängetasche. Polyester 600D RPET. Gepolstert.
 Bandoulière. Polyester 600D RPET. Rembourrée.
 Schoudertas. Polyester 600D RPET. Gewatteerd.

36 x 27 x 8 cm 30 Print Code: G(1), N(8)



Pirok 6845



Document Bag. Polyester 600D RPET. Padded Laptop and Tablet Compartment.
 Dokumententasche. Polyester 600D RPET. Gepolsterte Laptoptasche und Tablet.
 Porte-Documents. Polyester 600D RPET. Pochette Rembourrée pour Portable et Tablette.

Aktentas. Polyester 600D RPET. Gewatteerd Laptop en Tablet Compartment.

38 x 28 x 5 cm 40 Print Code: G(1), N(8)

Divaz 6846

Document Bag. Polyester 600D RPET.
 Dokumententasche. Polyester 600D RPET.
 Porte-Documents. Polyester 600D RPET.
 Aktentas. Polyester 600D RPET.

39 x 27 x 3.5 cm 100 / 20 Print Code: G(1), N(8)

15" LAPTOP COMPARTMENT

RPET **Bakex 6910**

Briefcase. Polyester 300D RPET. Gepolstert. Gepolsterte Laptopasche.
 Akten tasche. Polyester 300D RPET. Rembourré. Pochette Rembourrée pour Portable.
 Akten tas. Polyester 300D RPET. Gewatteerd. Gewatteerd Laptop Compartment.

 40 x 29 x 8 cm  30  Print Code: N(8)



06



02

08



06

Derek 1044

Document Bag. Polyester 600D RPET. Padded.
 Dokumententasche. Polyester 600D RPET. Gepolstert.
 Porte-Documents. Polyester 600D RPET. Rembourré.
 Akten tas. Polyester 600D RPET. Gewatteerd.

 38 x 27 x 6 cm  30  Print Code: N(8)



08

02



-RECYCLED-
LEATHER

 15"
LAPTOP
COMPARTMENT

Poirel 1852

06

Document Bag. Recycled Leather. Padded.
 Dokumententasche. Recycling Leder. Gepolstert.
 Porte-Documents. Cuir Recyclé. Rembourré.
 Akten tas. Gerecycled Leer. Gewatteerd.

 40 x 31 cm  30  Print Code: G(1), L2



18

ANTONIO MIRO

**Mitchel 7363**

Briefcase. Polyester 600D. Padded. Padded Laptop Compartment.
 Akten tasche. Polyester 600D. Gepolstert. Gepolsterte Laptopasche.
 Malette. Polyester 600D. Rembourré. Pochette Rembourrée pour Portable.
 Akten tas. Polyester 600D. Gewatteerd. Gewatteerd Laptop Compartment.

 41 x 32 x 6 cm  20  Print Code: N(8)





Sektor 3402



LAPTOP
COMPARTMENT

Briefcase. Polyester 1680D. Padded Laptop Compartment.
Aktentasche. Polyester 1680D. Gepolsterte Laptotasche.
Malette. Polyester 1680D. Pochette Rembourrée pour Portable.
Aktentas. Polyester 1680D. Gewatteerd Laptop Compartment.

38.5 x 31 x 14.5 cm 20 / 5 Print Code: G(1), N(8)



Baldony 5591



TABLET
COMPARTMENT



LAPTOP
COMPARTMENT



TROLLEY
STRAP

Document Bag. Polyester 600D. USB Connection. Padded Laptop and Tablet Compartment.
Dokumententasche. Polyester 600D. USB Anschluss. Gepolsterte Laptotasche und Tablet.
Porte-Documents. Polyester 600D. Connexion USB. Pochette Rembourrée pour Portable et Tablette.
Aktentas. Polyester 600D. USB Verbindung. Gewatteerd Laptop en Tablet Compartment.

38 x 29.5 x 8.5 cm 40 Print Code: G(1), N(8)



Zestar 5063



TROLLEY
STRAP

Document Bag. Polyester 600D.
Dokumententasche. Polyester 600D.
Porte-Documents. Polyester 600D.
Aktentas. Polyester 600D.

38 x 29.5 x 8.5 cm 40 Print Code: G(1), N(8)



Lenket 6216



TABLET
COMPARTMENT



LAPTOP
COMPARTMENT



TROLLEY
STRAP

Document Bag. Polyester 300D. RFID Pocket Protection. USB Connection. Padded Laptop and Tablet Compartment.
Dokumententasche. Polyester 300D. Tasche mit RFID Schutz. USB Anschluss. Gepolsterte Laptotasche und Tablet.
Porte-Documents. Polyester 300D. Poche avec Protecteur RFID. Connexion USB. Pochette Rembourrée pour Portable et Tablette.
Aktentas. Polyester 300D. Zak met RFID Bescherming. USB Verbindung. Gewatteerd Laptop en Tablet Compartment.

38 x 29.5 x 8.5 cm 40 Print Code: G(1), N(8)

**RFID
PROTECTION**

RECYCLED
COTTON

CANVAS



02



03

13

19

Baiplur 1450

Document Bag. 100% Recycled Cotton.
 Dokumententasche. 100% Recycling Baumwolle.
 Porte-Documents. 100% Coton Recyclé.
 Aktentas. 100% Gerecycled Katoen.

38 x 28 x 4 cm 50 Print Code: G(1), N(8)



13



06

Gibson 1448

Document Bag. Canvas/ PU. Padded. Padded Laptop and Tablet Compartment.

Dokumententasche. Segeltuch/ PU. Gepolstert. Gepolsterte Laptoptasche und Tablet.

Porte-Documents. Toile/ Similicuir. Rembourré. Pochette Rembourrée pour Portable et Tablette.

Aktentas. Canvas/ PU. Gewatteerd. Gewatteerd Laptop en Tablet Compartment.

40 x 32 x 12 cm 10 Print Code: G(1), N(8)



New

Tramez 20201

Document Bag. Canvas/ PU. Padded. Padded Laptop Compartment.
 Dokumententasche. Segeltuch/ PU. Gepolstert. Gepolsterte Laptoptasche.
 Porte-Documents. Toile/ Similicuir. Rembourré. Pochette Rembourrée pour Portable.
 Aktentas. Canvas/ PU. Gewatteerd. Gewatteerd Laptop Compartment.

40 x 30 x 9 cm 10 Print Code: G(1), N(8)



02

Bernice 3768

Document Bag. Non-Woven.
 Dokumententasche. Non-Woven.
 Porte-Documents. T.N.T.
 Aktentas. Non-Woven.

36.2 x 30 x 9 cm 100/20
 Print Code: G(1), N(8)



13

03

04

19

Milán 8652

Document Bag. Polyester 600D.
 Dokumententasche. Polyester 600D.
 Porte-Documents. Polyester 600D.
 Aktentas. Polyester 600D.

24 x 32 x 4 cm 50
 Print Code: G(1), N(8)



06



02

117

07

03



13

Verse 3103

Document Bag, Polyester 600D.
Dokumententasche, Polyester 600D.
Porte-Documents, Polyester 600D.
Aktentas, Polyester 600D.

39 x 32 x 9 cm 25 Print Code: G(1), N(8)



19

03

02



117

Amazon 3477

Document Bag, Polyester 600D.
Dokumententasche, Polyester 600D.
Porte-Documents, Polyester 600D.
Aktentas, Polyester 600D.

37 x 29 x 9 cm 50 Print Code: G(1), N(8)



02

19

04

03



06

Konfer 3208

Document Bag, Polyester 600D.
Dokumententasche, Polyester 600D.
Porte-Documents, Polyester 600D.
Aktentas, Polyester 600D.

38 x 29.5 x 9 cm 50 Print Code: G(1), N(8)



03

02

13



06

Hirkop 4613

Document Bag, Polyester 600D.
Dokumententasche, Polyester 600D.
Porte-Documents, Polyester 600D.
Aktentas, Polyester 600D.

38 x 29.5 x 9 cm 50 Print Code: G(1), N(8)



02

19

03

04



117

Essentials Trolleys



TSA COMBINATION LOCK



Kleintor 6044



Trolley, ABS, Rigid, 8 Rotating Wheels, Padded Laptop Compartment, TSA Combination Lock.
Trolley, ABS, Starre, 8 Drehende Räder, Gepolsterte Laptoptasche, TSA Sicherheitsverschluss.
Trolley, ABS, Rigide, 8 Roues Tournantes, Pochette Rembourrée pour Portable, Fermeture Sécurité TSA.
Trolley, ABS, Hard, 8 Draaiende Wielen, Gewatteerd Laptop Compartment, TSA Veiligheidsluiting.

40 x 51 x 21.5 cm 1 Print Code: J(1)



Zoidel 5238



Trolley, Nylon, 8 Rotating Wheels, Padded Laptop Compartment, Combination Lock.
Trolley, Nylon, 8 Drehende Räder, Gepolsterte Laptoptasche, Sicherheitsverschluss.
Trolley, Nylon, 8 Roues Tournantes, Pochette Rembourrée pour Portable, Fermeture Sécurité.
Trolley, Nylon, 8 Draaiende Wielen, Gewatteerd Laptop Compartment, Veiligheidsluiting.

38 x 48 x 25 cm 2 Print Code: J(8)



Ibex 9977



Trolley, Polyester 1680D, Padded Laptop Compartment, Metal Padlock Included.
Trolley, Polyester 1680D, Gepolsterte Laptoptasche, Metallschloss inklusive.
Trolley, Polyester 1680D, Pochette Rembourrée pour Portable, Cadenas Métal Incluse.
Trolley, Polyester 1680D, Gewatteerd Laptop Compartment, Metalen Hangslot Inclusief.

42.5 x 40 x 24 cm 4 Print Code: J(8)





Sleiter 1471



Document Bag Backpack. Polyester 300D/ PU. Padded. Padded Laptop and Tablet Compartment.
 Dokumententasche Rucksack. Polyester 300D/ PU. Gepolstert. Gepolsterte Laptoptasche und Tablet.
 Sac à Dos Porte-Documents. Polyester 300D/ Similicuir. Rembourré. Pochette Rembourrée pour Portable et Tablette.
 Aktentas Ruzgak. Poliestere 300D/ PU. Gewatteerd. Gewatteerd Laptop en Tablet Compartment.

📏 29 x 45 x 16 cm 📖 10 🖨️ Print Code: I(8)



Hurkon 6509



Document Bag Backpack. Polyester 300D/ PU. Padded. Padded Laptop Compartment.
 Dokumententasche Rucksack. Polyester 300D/ PU. Gepolstert. Gepolsterte Laptoptasche.
 Sac à Dos Porte-Documents. Polyester 300D/ Similicuir. Rembourré. Pochette Rembourrée pour Portable.
 Aktentas Ruzgak. Polyester 300D/ PU. Gewatteerd. Gewatteerd Laptop Compartment.

📏 32 x 41 x 12.5 cm 📖 10 🖨️ Print Code: I(8)



Sulkan 6620

Document Bag Backpack. Polyester 600D. USB Connection. Padded. Padded Laptop Compartment.
 Dokumententasche Rucksack. Polyester 600D. USB Anschluss. Gepolstert. Gepolsterte Laptoptasche.
 Sac à Dos Porte-Documents. Polyester 600D. Connexion USB. Rembourré. Pochette Rembourrée pour Portable.
 Aktentas Ruzgak. Polyester 600D. USB Verbindung. Gewatteerd. Gewatteerd Laptop Compartment.

📏 32 x 46 x 20 cm 📖 10 🖨️ Print Code: I(8)



Ingria 20882

Backpack. Polyester 600D RPET. Padded Laptop and Tablet Compartment.
 Padded Back and Shoulder Straps.
 Rucksack. Polyester 600D RPET. Gepolsterte Laptoptasche und Tablet.
 Gepolsterter Rücken und Schultergurte.
 Sac à Dos. Polyester 600D RPET. Pochette Rembourrée pour Portable et Tablette. Dos et Bretelles Rembourrées.
 Ruzgak. Polyester 600D RPET. Gewatteerd Laptop en Tablet Compartment.
 Gewatteerde Achterzijde en Schouderbanden.

📏 31 x 42 x 12 cm 📖 20 🖨️ Print Code: N(8)





EXTENDABLE 70 CM

Alikra 20999

Id Holder. Bamboo/ Wheat Straw/ PS. Extendable. Clip Included.
 Namensschild Halter. Bambus/ Weizenstroh/ PS. Ausziehbar. Gürtelclip Inklusive.
 Porte Badge. Bambou/ Paille de Blé/ PS. Extensible. Clip Inclusive.
 Id Houder. Bamboe/ Tarwestro/ PS. Verlengbaar. Clip Inclusief.

📏 Ø 3.2 x 1.1 cm 📦 1000 / 100 🏷️ Print Code: C(1), L1



Napper 6490

Id Holder. Extendable. Clip Included.
 Namensschild Halter. Ausziehbar. Gürtelclip Inklusive.
 Porte Badge. Extensible. Clip Inclusive.
 Id Houder. Verlengbaar. Clip Inclusief.

📏 3.3 x 5.5 x 1 cm 📦 1000 / 100 🏷️ Print Code: C(4)



EXTENDABLE 75 CM



EXTENDABLE 65 CM

Bosur 6489

Id Holder. Extendable. Clip Included.
 Namensschild Halter. Ausziehbar. Gürtelclip Inklusive.
 Porte Badge. Extensible. Clip Inclusive.
 Id Houder. Verlengbaar. Clip Inclusief.

📏 Ø 3.2 x 1.5 cm 📦 1000 / 100 🏷️ Print Code: C(4), V



EXTENDABLE 58 CM

Lemer 6169



Lanyard. Polyester. Extendable. Safety Catch.
 Schlüsselband. Polyester. Ausziehbar. Sicherheitsverschluss.
 Lanyard. Polyester. Extensible. Fermeture Sécurité.
 Lanyard. Polyester. Verlengbaar. Veiligheidsluiting.

📏 1.5 x 55 cm 📦 600 / 50 🏷️ Print Code: D(4), G(1), N(8), R, V



02

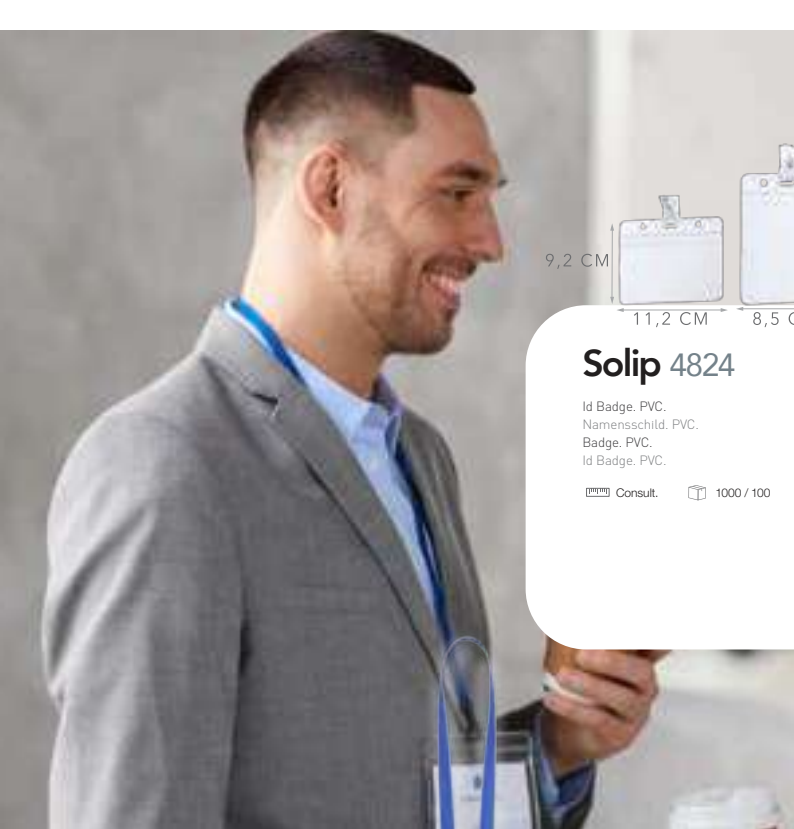

Solip 4824

Id Badge. PVC.
 Namensschild. PVC.
 Badge. PVC.
 Id Badge. PVC.

Consult. 1000 / 100 Print Code: C(1)



New

New



19



02

Maes 3709

Id Badge Lanyard. Polyester/ PVC.
 Namensschild Schlüsselband. Polyester/ PVC.
 Lanyard Porte-Badge. Polyester/ PVC.
 Badge Lanyard. Polyester/ PVC.

11 x 58 cm 1000 / 100
 Print Code: G(1), D(1)

ID BADGE INCLUDED

Fleck 20931

Id Badge Lanyard. Polyester/ PVC.
 Namensschild Schlüsselband. Polyester/ PVC.
 Lanyard Porte-Badge. Polyester/ PVC.
 Badge Lanyard. Polyester/ PVC.

7 x 54 cm 600 / 100
 Print Code: G(1), N(6)

ID BADGE INCLUDED

Beryel 20916

Id Badge Lanyard. Cork.
 Namensschild Schlüsselband. Kork.
 Lanyard Porte-Badge. Liège.
 Badge Lanyard. Kurk.

7.3 x 62 cm 400 / 50
 Print Code: D(1), G(1), L1, N(8)

ID BADGE INCLUDED





03

Bindel 3726

Id Badge, Aluminium.
Namensschild, Aluminium.
Badge, Aluminium.
Id Badge, Aluminium.

7 x 2.5 x 0.4 cm 1000 / 40
 Print Code: C(4), L1

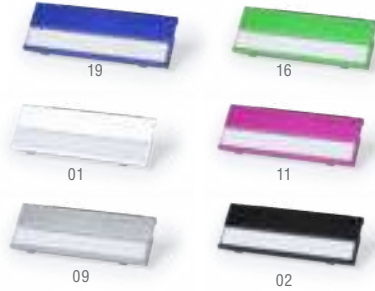

Upsin 5516

Id Badge.
Namensschild.
Badge.
Id Badge.

6,8 x 3,4 x 0,9 cm 1000 / 100 Print Code: C(4), L1



id Badge



Venkal 5517

Id Badge, Aluminium.
Namensschild, Aluminium.
Badge, Aluminium.
Id Badge, Aluminium.

7 x 2.5 x 0.7 cm 1000 / 100 Print Code: C(4)



Sartal 6955

Id Badge, Cork.
Namensschild, Kork.
Badge, Liège.
Id Badge, Kurk.

7 x 2.5 x 1 cm 2000 / 200 Print Code: C(4), L1



Feber 2321

Desktop Calendar: Cardboard.
Tischkalender: Pappe.
Calendrier Bureau: Carton.
Kalender: Karton.

22 x 13.8 x 6 cm 300 / 25
Print Code: E(4)



Ener 2320

Desktop Calendar: Cardboard.
Tischkalender: Pappe.
Calendrier Bureau: Carton.
Kalender: Karton.

11 x 13.8 x 6 cm 500 / 25
Print Code: E(4)



Larip 2509

Magnet Calendar: Cardboard.
Magnet Kalender: Pappe.
Calendrier Aimanté: Carton.
Magneet Kalender: Karton.

10 x 19 cm 300 / 50
Print Code: B(1)

Recycled Cardboard



Rendux 3892

Mousepad Calendar: PVC/ EVA. 12 Months. Anti-Slip.
Mauspad Kalender: PVC/ EVA. 12 Monate. Rutschfest.
Tapis Souris Calendrier: PVC/ EVA. 12 Mois. Antidérapant.
Muispad Kalender: PVC/ EVA. 12 Maanden. Anti-Slip.

23 x 18 cm 100 / 50
Print Code: E(4)



Flen 6920

Mousepad Calendar: Recycled Paper/ PVC/ EVA. 12 Months. Anti-Slip.
Mauspad Kalender: Recycling Papier/ PVC/ EVA. 12 Monate. Rutschfest.
Tapis Souris Calendrier: Papier Recyclé/ PVC/ EVA. 12 Mois. Antidérapant.
Muispad Kalender: Gerecycled Papier/ PVC/ EVA. 12 Maanden. Anti-Slip.

23 x 18 cm 100 / 50
Print Code: E(4)



Lasow 6921

Desktop Calendar: Recycled Cardboard.
Tischkalender: Recycling Pappe.
Calendrier Bureau: Carton Recyclé.
Kalender: Gerecycled Karton.

11 x 13.8 x 6 cm 500 / 25
Print Code: E(4)



17



The mark of
responsible forestry

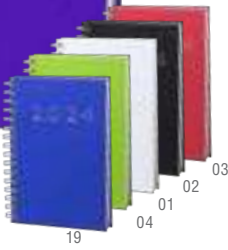

19

04

01

02

03



19

18

17

07

04

03

01

02



02

19

04

03

Witra 2547



Diary. PU. Daily Page.
Tagebuch. PU. Tag Seite.
Agenda. Similicuir. Page Journaliere.
Agenda. PU. Dagpagina.

15.8 × 21 × 2.4 cm 20 Print Code: E(1), T, U

Cannes 2497



Diary. PU. Daily Page.
Tagebuch. PU. Tag Seite.
Agenda. Similicuir. Page Journaliere.
Agenda. PU. Dagpagina.

14.7 × 21 × 2 cm 20 Print Code: E(1), T, U

Waltrex 2546



Diary. PU. Daily Page.
Tagebuch. PU. Tag Seite.
Agenda. Similicuir. Page Journaliere.
Agenda. PU. Dagpagina.

15 × 21 × 2.5 cm 20 Print Code: E(1), T, U



03

19

18

03

04

07

19

18

04

19

20

Wayro 2525



Diary. PU. Daily Page.
Tagebuch. PU. Tag Seite.
Agenda. Similicuir. Page Journaliere.
Agenda. PU. Dagpagina.

19 × 24.5 × 2.9 cm 20
Print Code: E(1), T, U

Toulouse 2283



Diary. PU. Daily Page.
Tagebuch. PU. Tag Seite.
Agenda. Similicuir. Page Journaliere.
Agenda. PU. Dagpagina.

17.5 × 24.5 × 2.5 cm 20
Print Code: E(1), T, U



04

19

20

Versalles 2101



Diary. PU. Daily Page.
Tagebuch. PU. Tag Seite.
Agenda. Similicuir. Page Journaliere.
Agenda. PU. Dagpagina.

17.5 × 24.5 × 2 cm 20
Print Code: E(1), T, U



19

13

04

Setren 2615



Diary. Paper. Daily Page.
Tagebuch. Papier. Tag Seite.
Agenda. Papier. Page Journaliere.
Agenda. Papier. Dagpagina.

15 × 21.2 × 1.8 cm 20
Print Code: E(1), T, U



Tradok 2733

Diary. Polyester RPET. Weekly Page.
Tagebuch. Polyester RPET. Wochenkalender.
Agenda. Polyester RPET. Page Hebdomadaire.
Agenda. Polyester RPET. Weekoverzicht.

15 × 21 × 1.5 cm 50 / 25 Print Code: E(1), N(8)



MAGNETIC CLOSURE

Flinex 2734

Diary. Cork. Daily Page.
Tagebuch. Kork. Tag Seite.
Agenda. Liège. Page Journalière.
Agenda. Kurk. Dagpagina.

15 × 21 × 2.5 cm 20 Print Code: E(1), L2, N(8)



RECYCLED LEATHER

Torkix 2735

Diary. Recycled Leather. Daily Page.
Tagebuch. Recycling Leder. Tag Seite.
Agenda. Cuir Recyclé. Page Journalière.
Agenda. Gerecycled Leer. Dagpagina.

17 × 21 × 2.5 cm 20 Print Code: E(1)



Larans 2732

Diary. Recycled Cardboard. Weekly Page.
Tagebuch. Recycling Pappe. Wochenkalender.
Agenda. Carton Recyclé. Page Hebdomadaire.
Agenda. Gerecycled Karton. Weekoverzicht.

15 × 21 × 1.5 cm 50 / 25 Print Code: E(1)



PINE SEEDS

Soriak 2736

Diary. Paper. Weekly Page. Pine Seeds Included.
Tagebuch. Papier. Wochenkalender. Piniensamen Inklusiv.
Agenda. Papier. Page Hebdomadaire. Graines de Pin Inclusives.
Agenda. Papier. Weekoverzicht. Pijnboom Zaden Inclusief.

13.5 × 21.5 × 1.5 cm 30 Print Code: E(1), T



The mark of responsible forestry

04

13

Fredex 2596

Diary. Paper. Daily Page.
Tagebuch. Papier. Tag Seite.
Agenda. Papier. Page Journalière.
Agenda. Papier. Dagpagina.

14.7 × 21 × 2 cm 20 Print Code: E(1), T

BACK LOGO

04 NOTE THE IDEA!





03



18



13

80 Sheets
Lined

Faty 21119

Noteпад. Fruit Paper/ Recycled Cardboard.
Hard Cover: 80 Sheets.
Notizblock. Obstpapier/ Recycling Pappe.
Hardcover-Abdeckung. 80 Blätter.
Bloc Notes. Papier de Fruits/ Carton Recyclé.
Couverture Rigide. 80 Feuilles.
Notitieblokje. Fruitpapier/ Gerecycled Karton.
Harde Kaft. 80 Blaadjes.

14.7 x 21 x 1.3 cm 50 / 25
 Print Code: E(4), W



04



614





Dalou 20847

Charger Notepad. Polyester 300D RPET/ Bambou. Wireless 15W. Hard Cover. 80 Sheets.
 Ladegerät Notizblock. Polyester 300D RPET/ Bambou. Drahtlos 15W. Hardcover-Abdeckung. 80 Blätter.
 Bloc Notes Chargeur. Polyester 300D RPET/ Bambou. Sans Fil 15W. Couverture Rigide. 80 Feuilles.
 Oplader Notitieblokje. Polyester 300D RPET/ Bamboe. Draadloos 15W. Harde Kaft. 80 Blaadjes.

14.5 x 21 x 1.8 cm 40 / 20 Print Code: G(1), L2, N(8)



Toskan 6616

Charger Notepad. Cork. Wireless 5W. 64 Sheets.
 Ladegerät Notizblock. Kork. Drahtlos 5W. 64 Blätter.
 Bloc Notes Chargeur. Liège. Sans Fil 5W. 64 Feuilles.
 Oplader Notitieblokje. Kurk. Draadloos 5W. 64 Blaadjes.

17.5 x 22.5 x 3 cm 20 Print Code: G(1), L2, N(8)



Bein 1135

Charger Notepad. Polyester 300D RPET. Wireless 10W. Hard Cover. 80 Sheets.
 Ladegerät Notizblock. Polyester 300D RPET. Drahtlos 10W. Hardcover-Abdeckung. 80 Blätter.
 Bloc Notes Chargeur. Polyester 300D RPET. Sans Fil 10W. Couverture Rigide. 80 Feuilles.
 Oplader Notitieblokje. Polyester 300D RPET. Draadloos 10W. Harde Kaft. 80 Blaadjes.

14.5 x 21.5 x 1.8 cm 40 / 20 Print Code: G(1), N(8)



Kevant 6185

Charger Notepad. Polyester 300D. Wireless 5W. Hard Cover. 80 Sheets.
 Ladegerät Notizblock. Polyester 300D. Drahtlos 5W. Hardcover-Abdeckung. 80 Blätter.
 Bloc Notes Chargeur. Polyester 300D. Sans Fil 5W. Couverture Rigide. 80 Feuilles.
 Oplader Notitieblokje. Polyester 300D. Draadloos 5W. Harde Kaft. 80 Blaadjes.

14.5 x 21.5 x 1.8 cm 40 / 20 Print Code: G(1), N(8)





02



08

Aquo 1893

06

Noteпад. Polyester 300D RPET/ Bambou. 80 Sheets.
 Notizblock. Polyester 300D RPET/ Bambou. 80 Blätter.
 Bloc Notes. Polyester 300D RPET/ Bambou. 80 Feuilles.
 Notitieblokje. Polyester 300D RPET/ Bamboe. 80 Blaadjes.

16.5 x 21 x 1.7 cm

40 / 20

Print Code: E(1), L2, N(8)

80 Sheets
Lined

New

 80 Sheets
Plain

Andrik 20953

06

Noteпад. Polyester 300D RPET/ Cork. 80 Sheets.
 Notizblock. Polyester 300D RPET/ Kork. 80 Blätter.
 Bloc Notes. Polyester 300D RPET/ Liège. 80 Feuilles.
 Notitieblokje. Polyester 300D RPET/ Kurk. 80 Blaadjes.

14.7 x 21 x 1.5 cm

50 / 25

Print Code: E(1), N(8)

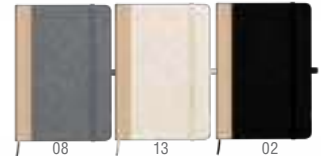

08

13

02

New



13



02



08

Alyxa 20955

06

Holder Notebook. Polyester 300D RPET/ Bambou. Hard Cover. 80 Sheets.
 Halter Notizbuch. Polyester 300D RPET/ Bambou. Hardcover-Abdeckung. 80 Blätter.
 Cahier Support. Polyester 300D RPET/ Bambou. Couverture Rigide. 80 Feuilles.
 Houder Notitieboek. Polyester 300D RPET/ Bamboe. Harde Kaft. 80 Blaadjes.

8.8 x 16 x 2 cm

100 / 50

Print Code: E(1), L1, N(8)

80 Sheets
Plain

New

RPET
&BAMBOO

Jibs 20954

06

Holder Noteпад. Polyester 300D RPET/ Bambou. Hard Cover. 80 Sheets.
 Halter Notizblock. Polyester 300D RPET/ Bambou. Hardcover-Abdeckung. 80 Blätter.
 Bloc Notes Support. Polyester 300D RPET/ Bambou. Couverture Rigide. 80 Feuilles.
 Houder Notitieblokje. Polyester 300D RPET/ Bamboe. Harde Kaft. 80 Blaadjes.

14.7 x 21 x 1.5 cm

50 / 25

Print Code: E(1), L1, N(8)



08

13

02

 80 Sheets
Plain

New

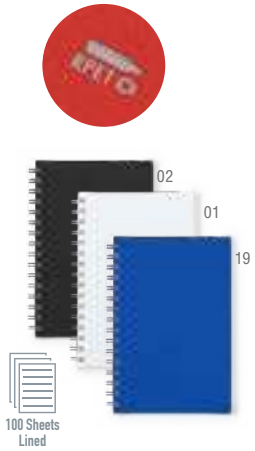

Kimberly 20230

Noteпад. Polyester 300D RPET. Hard Cover. 100 Sheets.
 Notizbuch. Polyester 300D RPET. Hardcover-Abdeckung. 100 Blätter.
 Bloc Notes. Polyester 300D RPET. Couverture Rigide. 100 Feuilles.
 Notitieblokje. Polyester 300D RPET. Harde Kaft. 100 Blaadjes.

15 x 21 x 1.5 cm 50 / 25 Print Code: E(1), N(8)

03



Maisux 1494

Holder Notebook. Polyester 300D RPET/ Wheat Straw/ PP. Hard Cover. 70 Sheets.
 Halter Notizbuch. Polyester 300D RPET/ Weizenstroh/ PP. Hardcover-Abdeckung. 70 Blätter.
 Cahier Support. Polyester 300D RPET/ Paille de Blé/ PP. Couverture Rigide. 70 Feuilles.
 Houder Notitieboek. Polyester 300D RPET/ Tarwestro/ PP. Harde Kaft. 70 Blaadjes.

15 x 21 x 1.5 cm 50 / 25 Print Code: E(1), N(8)

19

New

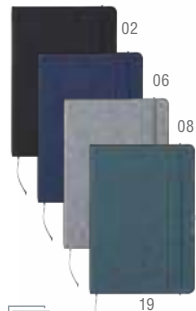

80 Sheets
Plain

Renolds 21071

Noteпад. Polyester 300D RPET. Hard Cover. 80 Sheets.
 Notizblock. Polyester 300D RPET. Hardcover-Abdeckung. 80 Blätter.
 Bloc Notes. Polyester 300D RPET. Couverture Rigide. 80 Feuilles.
 Notitieblokje. Polyester 300D RPET. Harde Kaft. 80 Blaadjes.

14.5 x 21 x 1 cm 50 / 25 Print Code: E(1), N(8)

03



Pacmel 1413

Noteпад. Polyester 600D RPET. Hard Cover. 100 Sheets.
 Notizblock. Polyester 600D RPET. Hardcover-Abdeckung. 100 Blätter.
 Bloc Notes. Polyester 600D RPET. Couverture Rigide. 100 Feuilles.
 Notitieblokje. Polyester 600D RPET. Harde Kaft. 100 Blaadjes.

14.7 x 21 x 1.5 cm 50 / 25 Print Code: E(1), N(8)



Meivax 6722

Noteпад. Polyester 600D RPET. Hard Cover. 80 Sheets.
 Notizblock. Polyester 600D RPET. Hardcover-Abdeckung. 80 Blätter.
 Bloc Notes. Polyester 600D RPET. Couverture Rigide. 80 Feuilles.
 Notitieblokje. Polyester 600D RPET. Harde Kaft. 80 Blaadjes.

14.7 x 21 x 1.5 cm 50 / 25 Print Code: E(1), N(8), R

19



New



Cesful 20935

Notepad. Polyester 300D RPET. Hard Cover. 100 Sheets.
 Notizblock. Polyester 300D RPET. Hardcover-Abdeckung. 100 Blätter.
 Bloc Notes. Polyester 300D RPET. Couverture Rigide. 100 Feuilles.
 Nottieblokje. Polyester 300D RPET. Harde Kaft. 100 Blaadjes.

14.5 × 21.5 × 1.5 cm 50 / 25 Print Code: E(1), N(8)



New



Staiger 20956

Mousepad Notebook. Polyester 300D RPET. Hard Cover. 100 Sheets.
 Mauspad Notizbuch. Polyester 300D RPET. Hardcover-Abdeckung. 100 Blätter.
 Cahier Tapis Souris. Polyester 300D RPET. Couverture Rigide. 100 Feuilles.
 Muispad Nottieboek. Polyester 300D RPET. Harde Kaft. 100 Blaadjes.

14.7 × 21 × 2 cm 50 / 25 Print Code: E(1), N(8)



Nibir 1131

Notepad. Felt RPET. 100 Sheets.
 Notizblock. Filz RPET. 100 Blätter.
 Bloc Notes. Feutrine RPET. 100 Feuilles.
 Nottieblokje. Vilt RPET. 100 Blaadjes.

15 × 22 × 2 cm 50 / 25 Print Code: E(1), N(8)



New



Fionap 20217

Notepad. Felt RPET. 100 Sheets.
 Notizbuch. Filz RPET. 100 Blätter.
 Bloc Notes. Feutrine RPET. 100 Feuilles.
 Nottieblokje. Vilt RPET. 100 Blaadjes.

15.5 × 21 × 1.5 cm 50 / 25
 Print Code: E(1), N(8)



New



Kobain 21050

Holder Notepad. Felt RPET/ Bambou. Hard Cover. 80 Sheets.
 Halter Notizblock. Filz RPET/ Bambus. Hardcover-Abdeckung. 80 Blätter.
 Bloc Notes Support. Feutrine RPET/ Bambou. Couverture Rigide. 80 Feuilles.
 Houder Nottieblokje. Vilt RPET/ Bamboe. Harde Kaft. 80 Blaadjes.

14.5 × 21.3 × 1.6 cm 50 / 25
 Print Code: E(1), L1, N(8)





Tefan 1412

Notepad. Recycled Leather. Hard Cover. 100 Sheets.
 Notizblock. Recycling Leder. Hardcover-Abdeckung. 100 Blätter.
 Bloc Notes. Cuir Recyclé. Couverture Rigide. 100 Feuilles.
 Notitieblokje. Gerecycled Leer. Harde Kaft. 100 Blaadjes.

14.7 x 21 x 1.5 cm 50 / 25 Print Code: E(1), W



100 Sheets
Lined

New

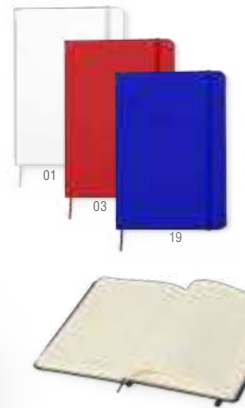

Zimax 20219

Notepad. Recycled PU. Hard Cover. 100 Sheets.
 Notizblock. Recycling PU. Hardcover-Abdeckung. 100 Blätter.
 Bloc Notes. Similicuir Recyclé. Couverture Rigide. 100 Feuilles.
 Notitieblokje. Gerecycled PU. Harde Kaft. 100 Blaadjes.

14.7 x 21 x 1.5 cm 50 / 25 Print Code: E(1), T, W



100 Sheets
Lined



Chancy 1889

Notepad. 100% Recycled Cotton. Hard Cover. 100 Sheets.
 Notizblock. 100% Recycling Baumwolle. Hardcover-Abdeckung. 100 Blätter.
 Bloc Notes. 100% Coton Recyclé. Couverture Rigide. 100 Feuilles.
 Notitieblokje. 100% Gerecycled Katoen. Harde Kaft. 100 Blaadjes.

14 x 21 x 1.5 cm 50 / 25 Print Code: E(1), N(8)



100 Sheets
Plain



Telmak 6159

Notepad. Cotton. Hard Cover. 80 Sheets.
 Notizblock. Baumwolle. Hardcover-Abdeckung. 80 Blätter.
 Bloc Notes. Coton. Couverture Rigide. 80 Feuilles.
 Notitieblokje. Katoen. Harde Kaft. 80 Blaadjes.

14 x 21 x 1.5 cm 50 / 25 Print Code: E(1), N(8)



80 Sheets
Plain





LINEN

New



80 Sheets
Plain



Hucka 20945

Notepad. Linen. Hard Cover. 80 Sheets.
Notizblock. Leinen. Hardcover-Abdeckung. 80 Blätter.
Bloc Notes. Lin. Couverture Rigide. 80 Feuilles.
Nottieblokje. Linnen. Harde Kaft. 80 Blaadjes.

 14.5 x 21 x 1.2 cm  50 / 25  Print Code: E(1), N(8)



LINEN

New



Yacard 20944

Notepad. Cork/ Linen. Hard Cover. 80 Sheets.
Notizblock. Kork/ Leinen. Hardcover-Abdeckung. 80 Blätter.
Bloc Notes. Liège/ Lin. Couverture Rigide. 80 Feuilles.
Nottieblokje. Kurk/ Linnen. Harde Kaft. 80 Blaadjes.

 14.7 x 21 x 1.4 cm  50 / 25  Print Code: E(1), L2, N(8)





80 Sheets
Plain



100 Sheets
Plain

Bluster 6338

Notepad. Cork/ PU. Hard Cover. 100 Sheets.
Notizblock. Kork/ PU. Hardcover-Abdeckung. 100 Blätter.
Bloc Notes. Liège/ Similicuir. Couverture Rigide. 100 Feuilles.
Nottieblokje. Kurk/ PU. Harde Kaft. 100 Blaadjes.

 14.7 x 21 x 1.5 cm  50 / 25  Print Code: E(1), L2, N(8), T, W



80 Sheets
Plain

Brastel 6394

Notepad. Cork/ Cotton. Hard Cover. 80 Sheets. Cork/ Wheat Straw/ ABS Pen Included. Black Ink.
Notizblock. Kork/ Baumwolle. Hardcover-Abdeckung. 80 Blätter. Kork/ Weizenstroh/ ABS Kugelschreiber
Inklusive. Schwarze Tinte.
Bloc Notes. Liège/ Coton. Couverture Rigide. 80 Feuilles. Stylo Liège/ Paille de Blé/ ABS Inctuse. Encre
Noire.
Nottieblokje. Kurk/ Katoen. Harde Kaft. 80 Blaadjes. Pen Kurk/ Tarwestro/ ABS Inclusief. Zwarte Inkt.

 14.5 x 21 x 1.5 cm  50 / 25  Print Code: E(1), B(1), L1, L2, N(8), W



Hartil 5980

Notepad. Cork. Hard Cover. 80 Sheets.
 Notizblock. Kork. Hardcover-Abdeckung. 80 Blätter.
 Bloc Notes. Liège. Couverture Rigide. 80 Feuilles.
 Notitieblokje. Kurk. Harde Kaft. 80 Blaadjes.

14 × 21 × 1.5 cm 50 / 25 Print Code: E(1), L2, N(8), W



80 Sheets
Plain



Coquel 6729

Notepad. Cork. Hard Cover. 100 Sheets.
 Notizblock. Kork. Hardcover-Abdeckung. 100 Blätter.
 Bloc Notes. Liège. Couverture Rigide. 100 Feuilles.
 Notitieblokje. Kurk. Harde Kaft. 100 Blaadjes.

14.7 × 21 × 1.5 cm 50 / 25 Print Code: E(1), L2, N(8)



100 Sheets
Plain



Xiankal 6604

Notebook. Cork. Hard Cover. 100 Sheets.
 Notizbuch. Kork. Hardcover-Abdeckung. 100 Blätter.
 Cahier. Liège. Couverture Rigide. 100 Feuilles.
 Notitieboek. Kurk. Harde Kaft. 100 Blaadjes.

16 × 21 × 2.2 cm 40 / 20 Print Code: E(1), L2, N(8)



100 Sheets
Lined



Fromky 1416

Holder Notebook. Cork/ Wheat Straw/ PP. Hard Cover. 70 Sheets.
 Halter Notizbuch. Kork/ Weizenstroh/ PP. Hardcover-Abdeckung. 70 Blätter.
 Cahier Support. Liège/ Paille de Blé/ PP. Couverture Rigide. 70 Feuilles.
 Houder Notitieboek. Kurk/ Tarwestro/ PP. Harde Kaft. 70 Blaadjes.

15 × 21 × 1.5 cm 50 / 25 Print Code: E(1), L2, N(8)



70 Sheets
Lined



Marinix 20958

Holder Notebook. Cork/ Bamboo. Hard Cover. 80 Sheets. Recycled Cardboard Pen Included.

Halter Notizbuch. Kork/ Bambus. Hardcover-Abdeckung. 80 Blätter. Recycling Pappe Kugelschreiber Inklusiv.

Cahier Support. Liège/ Bambou. Couverture Rigide. 80 Feuilles. Stylo Carton Recyclé Inclusif.

Houder Notitieboek. Kurk/ Bamboe. Harde Kaft. 80 Blaadjes. Pen Gerecycled Karton Inclusief.

10.5 x 15.5 x 2 cm 100 / 50
Print Code: B(4), E(4), L1



Drizax 20957

Holder Notepad. Cork/ Bamboo. Hard Cover. 100 Sheets.

Halter Notizblock. Kork/ Bambus. Hardcover-Abdeckung. 100 Blätter.

Bloc Notes Support. Liège/ Bambou. Couverture Rigide. 100 Feuilles.

Houder Notitieblokje. Kurk/ Bamboe. Harde Kaft. 100 Blaadjes.

14.7 x 21 x 1.6 cm 50 / 25
Print Code: E(1), L1, N(8)



Teyaki 20960

Notebook. Cork. 80 Sheets. Recycled Cardboard Pen Included.

Notizbuch. Kork. 80 Blätter. Recycling Pappe Kugelschreiber Inklusiv.

Cahier. Liège. 80 Feuilles. Stylo Carton Recyclé Inclusif.

Notitieboek. Kurk. 80 Blaadjes. Pen Gerecycled Karton Inclusief.

14.8 x 10.5 x 1 cm 100 / 50
Print Code: B(4), E(4), N(8)



Gienah 20959

Notebook. Cork. 80 Sheets. Recycled Cardboard Pen Included.

Notizbuch. Kork. 80 Blätter. Recycling Pappe Kugelschreiber Inklusiv.

Cahier. Liège. 80 Feuilles. Stylo Carton Recyclé Inclusif.

Notitieboek. Kurk. 80 Blaadjes. Pen Gerecycled Karton Inclusief.

16.5 x 21 x 1 cm 50 / 25
Print Code: E(4), B(4), N(8)



NOTE THE IDEA!



02

80 Sheets
Lined

06

13

New



08

Gasmon 20961

Notebook. Bamboo/ Polyester RPET. Hard Cover. 80 Sheets.
 Notizbuch. Bambus/ Polyester RPET. Hardcover-Abdeckung. 80 Blätter.
 Cahier. Bambou/ Polyester RPET. Couverture Rigide. 80 Feuilles.
 Notitieboek. Bamboe/ Polyester RPET. Harde Kaft. 80 Blaadjjes.

17 x 21 cm 50 / 25 Print Code: E(1), L2

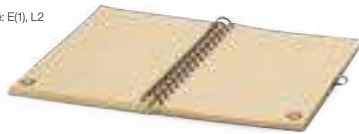

Palmex 6157

Notebook. Bamboo. Hard Cover. 80 Sheets.
 Notizbuch. Bambus. Hardcover-Abdeckung. 80 Blätter.
 Cahier. Bambou. Couverture Rigide. 80 Feuilles.
 Notitieboek. Bamboe. Harde Kaft. 80 Blaadjjes.

17 x 21.5 x 1.8 cm 50 / 25 Print Code: E(1)

80 Sheets
Lined80 Sheets
Lined

Polnar 6401

Notebook. Bamboo. Hard Cover. 80 Sheets. Bamboo Pen Included. Black Ink.
 Notizbuch. Bambus. Hardcover-Abdeckung. 80 Blätter. Bambus Kugelschreiber Inklusive. Schwarze Tinte.
 Cahier. Bambou. Couverture Rigide. 80 Feuilles. Stylo Bambou Inclusive. Encre Noire.
 Notitieboek. Bamboe. Harde Kaft. 80 Blaadjjes. Bamboe Pen Inclusief. Zwarte Inkt.

17 x 21.5 x 1.8 cm 50 / 25 Print Code: E(1), B(4)

70 Sheets
Lined

Tumiz 6018

Notebook. Bamboo. Hard Cover. 70 Sheets. Bamboo Pen Included. Jumbo Refill.
 Notizbuch. Bambus. Hardcover-Abdeckung. 70 Blätter. Bambus Kugelschreiber Inklusive. Jumbo Mine.
 Cahier. Bambou. Couverture Rigide. 70 Feuilles. Stylo Bambou Inclusive. Recharge Jumbo.
 Notitieboek. Bamboe. Harde Kaft. 70 Blaadjjes. Bamboe Pen Inclusief. Jumbo Refill.

10 x 15 x 1.6 cm 100 / 25 Print Code: E(1), B(4)

MADE FROM
COFFEE
-FIBER-



Lando 1414

Noteпад. Coffee Fibre/ PP. Hard Cover. 100 Sheets.
Notizblock. Kaffeefaser/ PP. Hardcover-Abdeckung. 100 Blätter.
Bloc Notes. Fibre de café/ PP. Couverture Rigide. 100 Feuilles.
Notitieblokje. Koffievezel/ PP. Harde Kaft. 100 Blaadjes.

 14.7 x 21 x 1.5 cm  30  Print Code: E(1)  100 Sheets Lined



New



 80 Sheets Lined

Alanna 2022

Notebook. Coffee Fibre/ PP. 80 Sheets. Coffee Fibre/ PP Pen Included.
Notizbuch. Kaffeefaser/ PP. 80 Blätter. Kaffeefaser/ PP Kugelschreiber Inklusive.
Cahier. Fibre de café/ PP. 80 Feuilles. Stylo Fibre de café/ PP Inclusie.
Notttieboek. Koffievezel/ PP. 80 Blaadjes. Pen Koffievezel/ PP Inclusief.

 15 x 21.3 x 1.5 cm  50 / 25  Print Code: E(1), B(1)



New



 70 Sheets Lined

Pacam 20941

Notebook. Coffee Fibre/ PP. 70 Sheets. Coffee Fibre/ PP Pen Included.
Notizbuch. Kaffeefaser/ PP. 70 Blätter. Kaffeefaser/ PP Kugelschreiber Inklusive.
Cahier. Fibre de café/ PP. 70 Feuilles. Stylo Fibre de café/ PP Inclusie.
Notttieboek. Koffievezel/ PP. 70 Blaadjes. Pen Koffievezel/ PP Inclusief.

 9.9 x 14.5 x 1.2 cm  100 / 50  Print Code: E(1), B(1)





-RECYCLED- MILK CARTON

New

80 Sheets
Lined

Edilax 20938

Notebook. Recycled Milk Cartons. Hard Cover. 80 Sheets.
 Notizbuch. Recycelte Milchkartons. Hardcover-Abdeckung. 80 Blätter.
 Cahier. Cartons de Lait Recyclés. Couverture Rigide. 80 Feuilles.
 Notitieboek. Gerecycleerde Melkpakken. Harde Kaft. 80 Blaadjes.

15 × 21 × 1.7 cm 50 / 25 Print Code: E(4), B(4)



Agnila 20936

Notebook. Recycled Milk Cartons. 60 Sheets.
 Notizbuch. Recycelte Milchkartons. 60 Blätter.
 Cahier. Cartons de Lait Recyclés. 60 Feuilles.
 Notitieboek. Gerecycleerde Melkpakken. 60 Blaadjes.

14.4 × 21 × 0.7 cm 100 / 50 Print Code: E(4)

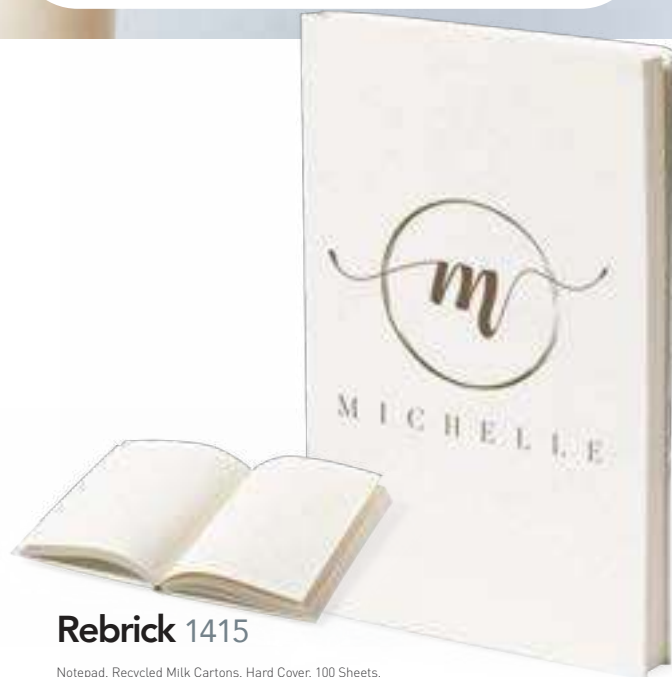
60 Sheets
Lined

Rebrick 1415

Notepad. Recycled Milk Cartons. Hard Cover. 100 Sheets.
 Notizblock. Recycelte Milchkartons. Hardcover-Abdeckung. 100 Blätter.
 Bloc Notes. Cartons de Lait Recyclés. Couverture Rigide. 100 Feuilles.
 Notitieblokje. Gerecycleerde Melkpakken. Harde Kaft. 100 Blaadjes.

14 × 21 × 1.5 cm 40 / 20 Print Code: E(4)

100 Sheets
Lined

New

80 Sheets
Lined

Heiwor 20939

Notebook. Recycled Milk Cartons. Hardcover. 80 Sheets. Recycled Milk Cartons Pen Included.

Notizbuch. Recycelte Milchkartons. Hardcover-Abdeckung. 80 Blätter. Recycelte Milchkartons Kugelschreiber Inklusiv.

Cahier. Cartons de Lait Recyclés. Couverture Rigide. 80 Feuilles. Stylo Cartons de Lait Recyclés Inclus.

Notitieboek. Gerecycleerde Melkpakken. Harde Kaft. 80 Blaadjes. Gerecycleerde Melkpakken Pen Inclusief.

9.6 x 15.2 x 1.7 cm 100 / 50 Print Code: B(4), E(4)



RECYCLED
MILK CARTON

New



Vidmar 20937

Notepad. Recycled Milk Cartons. 200 Sheets 7,5 x 8 cm.

Notizzettelbox. Recycelte Milchkartons. 200 Blätter 7,5 x 8 cm.

Porte Notes. Cartons de Lait Recyclés. 200 Feuilles 7,5 x 8 cm.

Plakmemohouder. Gerecycleerde Melkpakken. 200 Blaadjes 7,5 x 8 cm.

7.7 x 2.5 x 8 cm 100 / 50 Print Code: D(4)

80 Sheets
Lined

Minnak 1890

Holder Notebook. Recycled Milk Cartons/ Bamboo. Hardcover. 80 Sheets. Recycled Milk Cartons Pen Included.

Halter Notizbuch. Recycelte Milchkartons/ Bambus. Hardcover-Abdeckung. 80 Blätter. Recycelte Milchkartons Kugelschreiber Inklusiv.

Cahier Support. Cartons de Lait Recyclés/ Bambou. Couverture Rigide. 80 Feuilles. Stylo Cartons de Lait Recyclés Incluses.

Houder Notitieboek. Gerecycleerde Melkpakken/ Bamboe. Harde Kaft. 80 Blaadjes. Gerecycleerde Melkpakken Pen Inclusief.

8.8 x 14.7 x 1.7 cm 100 / 50 Print Code: E(4), L1

100 Sheets
Lined

Torya 1891

Holder Notebook. Recycled Milk Cartons/ Bamboo. Hardcover. 100 Sheets.

Halter Notizbuch. Recycelte Milchkartons/ Bambus. Hardcover-Abdeckung. 100 Blätter.

Cahier Support. Cartons de Lait Recyclés/ Bambou. Couverture Rigide. 100 Feuilles.

Houder Notitieboek. Gerecycleerde Melkpakken/ Bamboe. Harde Kaft. 100 Blaadjes.

14.5 x 21.3 x 1.7 cm 50 / 25 Print Code: E(4), L1

NOTE THE IDEA!



New

Kenta 20940

Notebook. Recycled Cardboard/ Paper made from stone extracts. 70 Sheets.
 Notizbuch. Recycling Pappe/ Papier aus steinextrakten. 70 Blätter.
 Cahier. Carton Recyclé/ Papier fabriqué à partir d'extraits de pierre. 70 Feuilles.
 Notitieboek. Gerecycled Karton/ Papier gemaakt van steen-extracten. 70 Blaadjes.

15 x 21.2 x 1.6 cm 50 / 25
 Print Code: E(1)

70 Sheets
Lined



New



70 Sheets
Lined

Amber 20221

Notebook. Paper made from stone extracts. Hard Cover. 70 Sheets. Natural Stone Extracts/ ABS Pen Included. Jumbo Refill.

Notizbuch. Papier aus steinextrakten. Hardcover-Abdeckung. 70 Blätter. Natursteinextrakte/ ABS Kugelschreiber Inklusiv. Jumbo Mine.
 Cahier. Papier fabriqué à partir d'extraits de pierre. Couverture Rigide. 70 Feuilles. Stylo Extraits de Pierre Naturelle/ ABS Incluse. Recharge Jumbo.
 Notitieboek. Papier gemaakt van steen-extracten. Harde Kaft. 70 Blaadjes. Pen Extracten van Natuursteen/ ABS Inclusief. Jumbo Refill.

16 x 18 x 1.5 cm 40 / 20 Print Code: E(1), B(4)



Quantum 6948

60 Sheets
Lined

Notebook. Paper made from stone extracts. 60 Sheets.
 Notizbuch. Papier aus steinextrakten. 60 Blätter.
 Cahier. Papier fabriqué à partir d'extraits de pierre. 60 Feuilles.
 Notitieboek. Papier gemaakt van steen-extracten. 60 Blaadjes.

14 x 20.6 x 1 cm 40 / 20 Print Code: E(1)



100% WATERPROOF

WHEAT STRAW

New



Fanny 20234

Notebook. Wheat Straw/ PP. 70 Sheets. Wheat Straw/ ABS Pen Included.
 Notizbuch. Weizenstroh/ PP. 70 Blätter. Weizenstroh/ ABS Kugelschreiber Inklusive.
 Cahier. Paille de Blé/ PP. 70 Feuilles. Stylo Paille de Blé/ ABS Inclusive.
 Nottieboek. Tarwestro/ PP. 70 Blaadjes. Pen Tarwestro/ ABS Inclusief.

10 x 14 x 1.5 cm 100 / 50 Print Code: E(4), B(4)



New



Emily 20223

Notebook. Wheat Straw/ PP. 80 Sheets. Wheat Straw/ PP Pen Included.
 Notizbuch. Weizenstroh/ PP. 80 Blätter. Weizenstroh/ PP Kugelschreiber Inklusive.
 Cahier. Paille de Blé/ PP. 80 Feuilles. Stylo Paille de Blé/ PP Inclusive.
 Nottieboek. Tarwestro/ PP. 80 Blaadjes. Pen Tarwestro/ PP Inclusief.

15 x 21.3 x 1.5 cm 50 / 25 Print Code: E(4), B(4)



NOTE THE IDEA!

RABS

Recycled ABS

New



Ciera 20220

Notebook. Recycled ABS. Hard Cover. 70 Sheets. RABS Pen Included.
 Notizbuch. Recycling ABS. Hardcover-Abdeckung. 70 Blätter. RABS Kugelschreiber Inklusive.
 Cahier. ABS Recyclé. Couverture Rigide. 70 Feuilles. Stylo RABS Inclusive.
 Nottieboek. Gerecycled ABS. Harde Kaft. 70 Blaadjes. Pen RABS Inclusief.

14 x 18 x 1.5 cm 50 / 25 Print Code: E(4), B(4)



Roshan 1407

Notebook. Wheat Straw/ PP. 80 Sheets.
 Notizbuch. Weizenstroh/ PP. 80 Blätter.
 Cahier. Paille de Blé/ PP. 80 Feuilles.
 Nottieboek. Tarwestro/ PP. 80 Blaadjes.

14.5 x 21 x 1.5 cm 50 / 25 Print Code: E(4)





Nigmar 20942

Notebook. Grass Paper. Hard Cover. 80 Sheets.
 Notizbuch. Graspapier. Hardcover-Abdeckung. 80 Blätter.
 Cahier. Papier d'Herbe. Couverture Rigide. 80 Feuilles.
 Notitieboek. Graspapier. Harde Kaft. 80 Blaadjes.

15 x 21.2 x 1.7 cm 50 / 25 Print Code: E(1)



New



Yerx 20943

Notepad. Grass Paper. Hard Cover. 80 Sheets.
 Notizblock. Graspapier. Hardcover-Abdeckung. 80 Blätter.
 Bloc Notes. Papier d'Herbe. Couverture Rigide. 80 Feuilles.
 Notitieblokje. Graspapier. Harde Kaft. 80 Blaadjes.

14 x 21 x 1.3 cm 50 / 25 Print Code: E(1)



FIELD
FLOWERS
SEEDS



New



Baupres 20952

Seeds Notepad. Cardboard. Hard Cover. 80 Sheets.
 Wildflowers.
 Samen Notizblock. Pappe. Hardcover-Abdeckung. 80
 Blätter. Wilde Blumen.
 Bloc Notes Ensemencé. Carton. Couverture Rigide.
 80 Feuilles. Fleurs Sauvages.
 Zaad Notitieblokje. Karton. Harde Kaft. 80 Blaadjes.
 Wilde Bloemen.

13.5 x 21 x 2.1 cm 30 Print Code: E(1)



New



Astrida 20951

Seeds Notebook. Cardboard. Hard Cover. 80 Sheets. Wildflowers.
 Samen Notizbuch. Pappe. Hardcover-Abdeckung. 80 Blätter.
 Wilde Blumen.
 Cahier Ensemencé. Carton. Couverture Rigide. 80 Feuilles.
 Fleurs Sauvages.

Zaad Notitieboek. Karton. Harde Kaft. 80 Blaadjes. Wilde
 Bloemen.
 14.3 x 2.2 x 2.1 cm 30 Print Code: E(1)





Seed Paper

60 Sheets
Plain

Derna 20949

Seeds Notebook. Seed Paper. 60 Sheets. Petunia Seeds Included. Assorted Coloured Flowers.

Samen Notizbuch. Samenpapier. 60 Blätter. Petuniensamen Inklusive. In verschiedenen Farben.

Cahier Ensemencé. Papier Ensemencé. 60 Feuilles. Graines de Pétunia Incluses. Fleurs Couleurs Diverses.

Zaad Notitieboek. Zaadpapier. 60 Bladjes. Petunia Zaden Inclusief. Assortiment van Gekleurde Bloemen.

 14.8 x 21 x 0.8 cm  100 / 50  Print Code: E(4)

60 Sheets
Plain

Maiwen 1887

Seeds Notepad. Seed Paper. 60 Sheets. Petunia Seeds Included. Assorted Coloured Flowers.

Samen Notizblock. Samenpapier. 60 Blätter. Petuniensamen Inklusive. In verschiedenen Farben.

Bloc Notes Ensemencé. Papier Ensemencé. 60 Feuilles. Graines de Pétunia Incluses. Fleurs Couleurs Diverses.

Zaad Notitieblokje. Zaadpapier. 60 Bladjes. Petunia Zaden Inclusief. Assortiment van Gekleurde Bloemen.

 14.5 x 21 x 0.8 cm  100 / 50  Print Code: E(4)

80 Sheets
Plain

Bitar 20950

Seeds Notebook. Seed Paper. 80 Sheets. Petunia Seeds Included. Assorted Coloured Flowers.

Samen Notizbuch. Samenpapier. 80 Blätter. Petuniensamen Inklusive. In verschiedenen Farben.

Cahier Ensemencé. Papier Ensemencé. 80 Feuilles. Graines de Pétunia Incluses. Fleurs Couleurs Diverses.

Zaad Notitieboek. Zaadpapier. 80 Bladjes. Petunia Zaden Inclusief. Assortiment van Gekleurde Bloemen.

 16 x 21 x 1.6 cm  50 / 25  Print Code: E(4)



RECYCLED CARDBOARD

New



Tempox 20166

Notepad. Recycled Cardboard. Hard Cover. 100 Sheets.
 Notizblock. Recycling Papp. Hardcover-Abdeckung. 100 Blätter.
 Bloc Notes. Carton Recyclé. Couverture Rigide. 100 Feuilles.
 Notitieblokje. Gerecycled Karton. Harde Kaft. 100 Blaadjes.

14.7 × 21 × 1.5 cm 50 / 25 Print Code: E(4), W



100 Sheets
Plain

New



Kanlio 20165

Notebook. Recycled Cardboard. 60 Sheets.
 Notizbuch. Recycling Papp. 60 Blätter.
 Cahier. Carton Recyclé. 60 Feuilles.
 Notitieboek. Gerecycled Karton. 60 Blaadjes.

14.4 × 21 × 0.8 cm 100 / 10
 Print Code: E(4)



60 Sheets
Plain

New



Hantz 20167

Notebook. Recycled Cardboard. Hard Cover. 80 Sheets.
 Notizbuch. Recycling Papp. Hardcover-Abdeckung. 80 Blätter.
 Cahier. Carton Recyclé. Couverture Rigide. 80 Feuilles.
 Notitieboek. Gerecycled Karton. Harde Kaft. 80 Blaadjes.

16.4 × 21.7 × 1.6 cm 50 / 25 Print Code: E(4)



80 Sheets
Plain



60 Sheets
Lined

Zurix 6108

Notebook. Recycled Cardboard. 60 Sheets.
Notizbuch. Recycling Pappe. 60 Blätter.
Cahier. Carton Recyclé. 60 Feuilles.
Nottieboek. Gerecycled Karton. 60 Blaadjes.

14.4 x 21 x 0.8 cm 100 / 10 Print Code: E(1)



02

13

04

Raysh 1133

Notebook. Recycled Cardboard. 60 Sheets.
Notizbuch. Recycling Pappe. 60 Blätter.
Cahier. Carton Recyclé. 60 Feuilles.
Nottieboek. Gerecycled Karton. 60 Blaadjes.

14.4 x 21 x 0.8 cm 100 / 50 Print Code: E(1)

60 Sheets
Plain

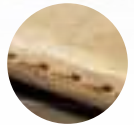

21

03

16



40 Sheets
Plain

Dienel 5118

Notebook. 40 Sheets.
Notizbuch. 40 Blätter.
Cahier. 40 Feuilles.
Nottieboek. 40 Blaadjes.

14 x 20.5 x 0.4 cm 100 / 10 Print Code: E(1)



02

19

04

Esteka 6837

Notebook. Recycled Cardboard. 60 Sheets.
Recycled Cardboard/ Wheat Straw/ ABS Pen
Included.
Notizbuch. Recycling Pappe. 60 Blätter.
Recycling Pappe/ Weizenstroh/ ABS
Kugelschreiber Inklusiv.
Cahier. Carton Recyclé. 60 Feuilles. Stylo Carton
Recyclé/ Paille de Blé/ ABS Incluses.
Nottieboek. Gerecycled Karton. 60 Blaadjes. Pen
Gerecycled Karton/ Tarwestroh/ ABS Inclusief.

15 x 21 x 0.6 cm 50 / 25 Print Code: E(1), B(4)

60 Sheets
Plain





Mecony 20962

Notebook. Recycled Cardboard. 80 Sheets Notepad. 25 Sticky Notes 9 x 9 cm. 100 Mini Sticky Notes 2 x 9 cm. Recycled Cardboard Pen Included.
 Notizbuch. Recycling Pappe. 80 Blätter Notizblock. 25 Haftnotizen 9 x 9 cm. 100 Mini Haftnotizen 2 x 9 cm. Recycling Pappe Kugelschreiber Inklusiv.
 Cahier. Carton Recyclé. Bloc 80 Feuilles. 25 Notes Adhésives 9 x 9 cm. 100 Mini Notes Adhésives 2 x 9 cm. Stylo Carton Recyclé Inclusif.
 Notitieboek. Gerecycled Karton. 80 Blaadjes Notepad. 25 Plakmemo's 9 x 9 cm. 100 Mini Plakmemo's 2 x 9 cm. Pen Gerecycled Karton Inclusief.

15.5 x 21 x 1.7 cm 50 / 25 Print Code: E(1), B(4)



80 Sheets
Plain



Tiblan 6109

Sticky Notepad. Recycled Cardboard. 60 Sheets. 125 Sticky Notes 1,2 x 4,4 cm. Haftender Notizblock. Recycling Pappe. 60 Blätter. 125 Haftnotizen 1,2 x 4,4 cm. Bloc Notes Adhésif. Carton Recyclé. 60 Feuilles. 125 Notes Adhésives 1,2 x 4,4 cm. Notitieblok Zelfklevend. Gerecycled Karton. 60 Blaadjes. 125 Plakmemo's 1,2 x 4,4 cm.

14.6 x 17.7 x 1.7 cm 100 / 50 Print Code: E(1)



60 Sheets
Lined



Makron 4237

Sticky Notepad. Recycled Cardboard. 70 Sheets Notepad. 25 Sticky Notes 7,5 x 10 cm. 125 Mini Sticky Notes 1,5 x 7,5 cm. Recycled Cardboard Pen Included.
 Notizblock. Recycling Pappe. 70 Blätter Notizblock. 25 Haftnotizen 7,5 x 10 cm. 125 Mini Haftnotizen 1,5 x 7,5 cm. Recycling Pappe Kugelschreiber Inklusiv.
 Bloc Notes. Carton Recyclé. Bloc 70 Feuilles. 25 Notes Adhésives 7,5 x 10 cm. 125 Mini Notes Adhésives 1,5 x 7,5 cm. Stylo Carton Recyclé Inclusif.
 Plakmemo-Blokje. Gerecycled Karton. 70 Blaadjes Notepad. 25 Plakmemo's 7,5 x 10 cm. 125 Mini Plakmemo's 1,5 x 7,5 cm. Pen Gerecycled Karton Inclusief.

21 x 20 x 1 cm 50 / 25 Print Code: F(1), B(4)



70 Sheets
Lined

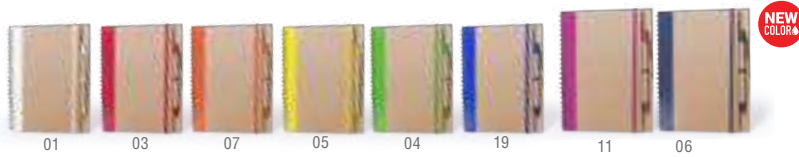

NEW
COLOR

Tunel 3437

Notebook. Recycled Cardboard. Hard Cover. 60 Sheets. Recycled Cardboard Pen Included.
 Notizbuch. Recycling Pappe. Hardcover-Abdeckung. 60 Blätter. Recycling Pappe Kugelschreiber Inklusive.
 Cahier. Carton Recyclé. Couverture Rigide. 60 Feuilles. Stylo Carton Recyclé Inclusé.
 Notitieboek. Gerecycled Karton. Harde Kaft. 60 Blaadjes. Pen Gerecycled Karton Inclusief.

16.5 x 21 x 1 cm 80 / 20 Print Code: E(1), B(4)

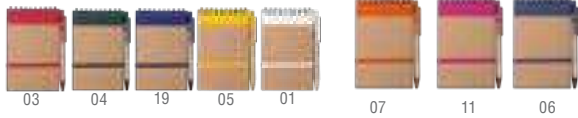
60 Sheets
PlainNEW
COLOR

Ecocard 3190

Notebook. Recycled Cardboard. Hard Cover. 70 Sheets. Recycled Cardboard Pen Included.
 Notizbuch. Recycling Pappe. Hardcover-Abdeckung. 70 Blätter. Recycling Pappe Kugelschreiber Inklusive.
 Cahier. Carton Recyclé. Couverture Rigide. 70 Feuilles. Stylo Carton Recyclé Inclusé.
 Notitieboek. Gerecycled Karton. Harde Kaft. 70 Blaadjes. Pen Gerecycled Karton Inclusief.

9.7 x 14.4 x 1 cm 100 / 50 Print Code: E(4), B(4)

70 Sheets
Lined

02

02



19

Mosku 5661

Notebook. Recycled Cardboard. Hard Cover. 70 Sheets. Pencil Case Included. 6 Pieces.
 Notizbuch. Recycling Pappe. Hardcover-Abdeckung. 70 Blätter. Etui Inklusive. 6 Stück.
 Cahier. Carton Recyclé. Couverture Rigide. 70 Feuilles. Trousse Inclusé. 6 Pièces.
 Notitieboek. Gerecycled Karton. Harde Kaft. 70 Blaadjes. Etui Inclusief. 6 Stück.

15.5 x 21 x 0.9 cm 50 / 25 Print Code: F(1)

70 Sheets
Plain

Neyla 6398

Notebook. Recycled Cardboard. Hard Cover. 80 Sheets. Recycled Cardboard Pen Included.
 Notizbuch. Recycling Pappe. Hardcover-Abdeckung. 80 Blätter. Recycling Pappe Kugelschreiber Inklusive.
 Cahier. Carton Recyclé. Couverture Rigide. 80 Feuilles. Stylo Carton Recyclé Inclusé.
 Notitieboek. Gerecycled Karton. Harde Kaft. 80 Blaadjes. Pen Gerecycled Karton Inclusief.

17.5 x 21 x 1.7 cm 50 / 25 Print Code: E(1), B(4)

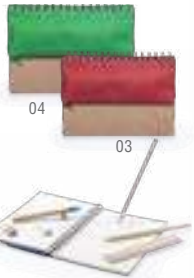
80 Sheets
Lined

04

03



SHARPENER

Tecnar



Tecnar 4730

Notebook. Recycled Cardboard. Hard Cover. 80 Sheets. Recycled Cardboard Pen Included.
 Notizbuch. Recycling Pappe. Hardcover-Abdeckung. 80 Blätter. Recycling Pappe Kugelschreiber Inklusive.
 Cahier. Carton Recyclé. Couverture Rigide. 80 Feuilles. Stylo Carton Recyclé Inclusif.
 Notitieboek. Gerecycled Karton. Harde Kaft. 80 Blaadjes. Pen Gerecycled Karton Inclusief.

23.7 x 29 x 2 cm 20 Print Code: E(4), B(4)



80 Sheets
Plain

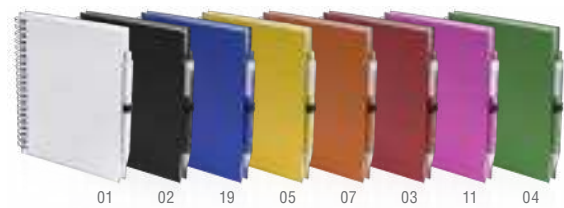

Koguel 4729

Notebook. Recycled Cardboard. Hard Cover. 70 Sheets. Recycled Cardboard Pen Included.
 Notizbuch. Recycling Pappe. Hardcover-Abdeckung. 70 Blätter. Recycling Pappe Kugelschreiber Inklusive.
 Cahier. Carton Recyclé. Couverture Rigide. 70 Feuilles. Stylo Carton Recyclé Inclusif.
 Notitieboek. Gerecycled Karton. Harde Kaft. 70 Blaadjes. Pen Gerecycled Karton Inclusief.

15 x 18.2 x 1.9 cm 50 / 25 Print Code: E(4), B(4)



70 Sheets
Plain



Gulliver 3389

Notebook, Recycled Cardboard, Hard Cover, 80 Sheets.
 Notizbuch, Recycling Pappe, Hardcover-Abdeckung, 80 Blätter.
 Cahier, Carton Recyclé, Couverture Rigide, 80 Feuilles.
 Notitieboek, Gerecycled Karton, Harde Kaft, 80 Blaadjes.

16.4 × 21.7 × 1.6 cm 50 / 25 Print Code: E(4)



Emerot 3388

Notebook, Recycled Cardboard, Hard Cover, 80 Sheets.
 Notizbuch, Recycling Pappe, Hardcover-Abdeckung, 80 Blätter.
 Cahier, Carton Recyclé, Couverture Rigide, 80 Feuilles.
 Notitieboek, Gerecycled Karton, Harde Kaft, 80 Blaadjes.

11.6 × 15.3 × 1.6 cm 100 / 25 Print Code: E(4)

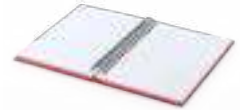

Zubar 6399

Notebook, Recycled Cardboard, Hard Cover, 80 Sheets.
 Notizbuch, Recycling Pappe, Hardcover-Abdeckung, 80 Blätter.
 Cahier, Carton Recyclé, Couverture Rigide, 80 Feuilles.
 Notitieboek, Gerecycled Karton, Harde Kaft, 80 Blaadjes.

15.5 × 21 × 1.8 cm 50 / 25 Print Code: E(4)

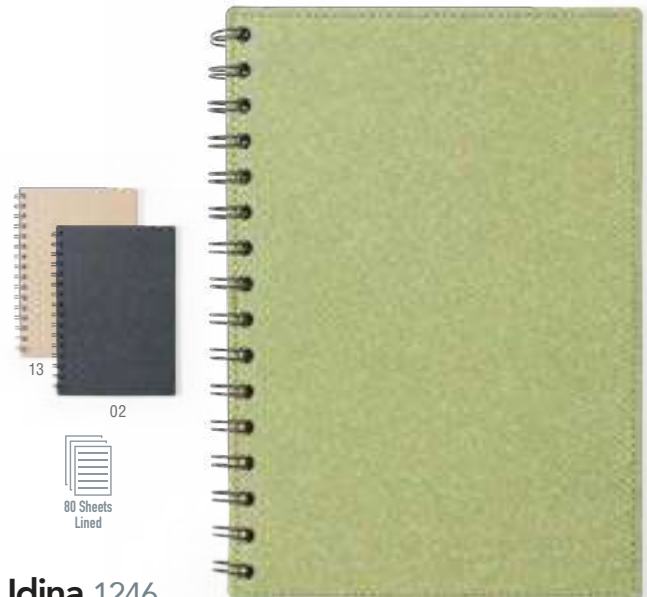

Idina 1246

Notebook, Recycled Cardboard, Hard Cover, 80 Sheets.
 Notizbuch, Recycling Pappe, Hardcover-Abdeckung, 80 Blätter.
 Cahier, Carton Recyclé, Couverture Rigide, 80 Feuilles.
 Notitieboek, Gerecycled Karton, Harde Kaft, 80 Blaadjes.

14.5 × 21 × 1 cm 40 / 20 Print Code: E(4)



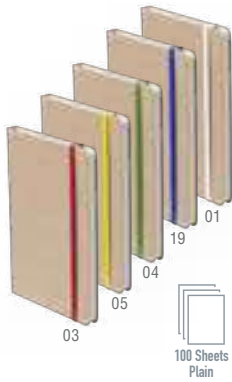

Raimok 5302

Noteпад. Recycled Cardboard. Hard Cover. 96 Sheets.
 Notizblock. Recycling Papp. Hardcover-Abdeckung. 96 Blätter.
 Bloc Notes. Carton Recyclé. Couverture Rigide. 96 Feuilles.
 Nottieblokje. Gerecycled Karton. Harde Kaft. 96 Blaadjes.

14.7 x 21 x 1.5 cm 50 / 25 Print Code: E(4), W



Klamax 1134

Noteпад. Recycled Cardboard. Hard Cover. 100 Sheets.
 Notizblock. Recycling Papp. Hardcover-Abdeckung. 100 Blätter.
 Bloc Notes. Carton Recyclé. Couverture Rigide. 100 Feuilles.
 Nottieblokje. Gerecycled Karton. Harde Kaft. 100 Blaadjes.

14.7 x 21 x 1.5 cm 50 / 25 Print Code: E(4), W



Kaffol 5672

Noteпад. Cardboard. Hard Cover. 100 Sheets.
 Notizblock. Papp. Hardcover-Abdeckung. 100 Blätter.
 Bloc Notes. Carton. Couverture Rigide. 100 Feuilles.
 Nottieblokje. Karton. Harde Kaft. 100 Blaadjes.

14.7 x 21 x 1.5 cm 50 / 25 Print Code: E(4), T, W



Boltuk 6201

USB Noteпад. Cardboard. Hard Cover. 100 Sheets. USB Memory 16GB Included.
 USB Notizblock. Papp. Hardcover-Abdeckung. 100 Blätter. USB Speicher 16GB Inklusiv.
 Bloc Notes USB. Carton. Couverture Rigide. 100 Feuilles. Clé USB 16GB Inclusive.
 USB Nottieblokje. Karton. Harde Kaft. 100 Blaadjes. USB Memory 16GB Inclusief.

14.2 x 21 x 1.5 cm 50 Print Code: F(4), T, W



NOTE THE IDEA!

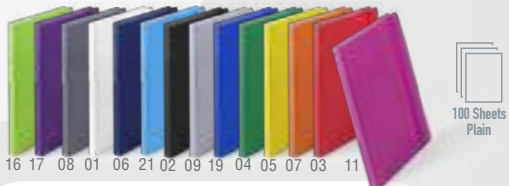

Cilux 4060

Notepad. PU. Hard Cover. 100 Sheets.
 Notizblock. PU. Hardcover-Abdeckung. 100 Blätter.
 Bloc Notes. Similicuir. Couverture Rigide. 100 Feuilles.
 Notitieblokje. PU. Harde Kaft. 100 Blaadjes.

14.7 x 21 x 1.5 cm 50 / 25 Print Code: E(4), T, W

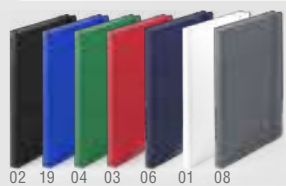

Ciluxlin 5300

Notepad. PU. Hard Cover. 100 Sheets.
 Notizblock. PU. Hardcover-Abdeckung. 100 Blätter.
 Bloc Notes. Similicuir. Couverture Rigide. 100 Feuilles.
 Notitieblokje. PU. Harde Kaft. 100 Blaadjes.

14.7 x 21 x 1.5 cm 50 / 25 Print Code: E(4), T, W

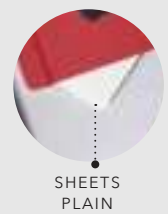
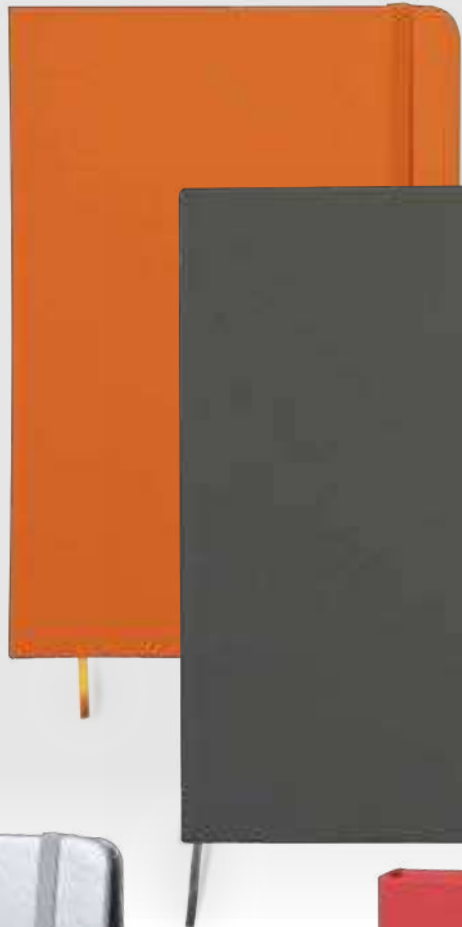

SHEETS PLAIN

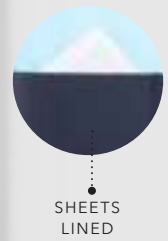

SHEETS LINED



Bodley 5939

Notepad. PU. Hard Cover. 80 Sheets.
 Notizblock. PU. Hardcover-Abdeckung. 80 Blätter.
 Bloc Notes. Similicuir. Couverture Rigide. 80 Feuilles.
 Notitieblokje. PU. Harde Kaft. 80 Blaadjes.

14.7 x 21 x 1.5 cm 50 / 25 Print Code: E(4), W



Kioto 6763

Antibacterial Notepad. PU. Hard Cover. 100 Sheets.
 Antibakteriell Notizblock. PU. Hardcover-Abdeckung. 100 Blätter.
 Bloc Notes Antibacterienne. Similicuir. Couverture Rigide. 100 Feuilles.
 Antibacterieel Notitieblokje. PU. Harde Kaft. 100 Blaadjes.

14.7 x 21 x 1.5 cm 50 / 25 Print Code: E(4), W



100 Sheets
Lined

Paldon 6617

Noteпад. PU. 100 Sheets.
Notizblock. PU. 100 Blätter.
Bloc Notes. Similicuir. 100 Feuilles.
Nottieblokje. PU. 100 Blaadjes.

14.5 x 21 x 1.3 cm 50 / 25 Print Code: E(1)

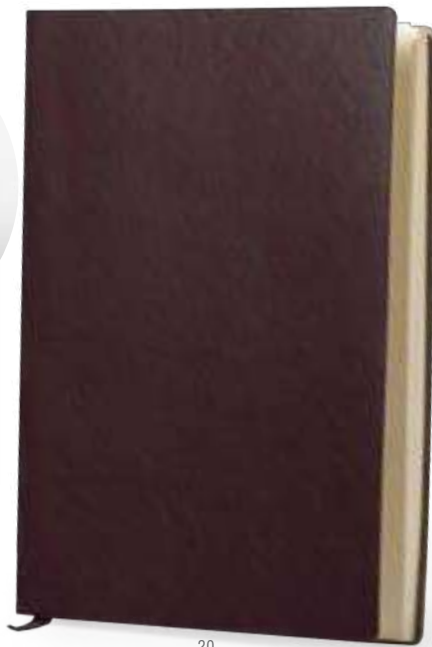

20

100 Sheets
Lined

Xeria 1940

Noteпад. PU. Hard Cover. 100 Sheets.
Notizblock. PU. Hardcover-Abdeckung. 100 Blätter.
Bloc Notes. Similicuir. Couverture Rigide. 100 Feuilles.
Nottieblokje. PU. Harde Kaft. 100 Blaadjes.

14.7 x 21 x 1.5 cm 50 / 25 Print Code: E(1), L2, W

100 Sheets
Lined

Robin 6839

Noteпад. PU. Hard Cover. 100 Sheets. Pen
Aluminium Included. Jumbo Refill.
Notizblock. PU. Hardcover-Abdeckung. 100 Blätter.
Kugelschreiber Aluminium Inklusiv. Jumbo Mine.
Bloc Notes. Similicuir. Couverture Rigide. 100
Feuilles. Stylo Aluminium Inclusive. Recharge Jumbo.
Nottieblokje. PU. Harde Kaft. 100 Blaadjes. Pen
Aluminium Inclusief. Jumbo Refill.

15.5 x 21 x 1.5 cm 40 / 20
Print Code: E(4), B(4), W



03



Koptul 6247

LCD Writing Tablet. Magnetic. Pen and Button Battery Included.
LCD-Schreibtablett. Magnetisch. Bleistift und Knopfzelle Inklusiv.
Tablette d'écriture LCD. Magnétique. Crayon et Pile Bouton Inclusive.
LCD Tablet om te Schrijven. Magnetisch. Potlood en Knopcel Batterij Inclusief.

14.7 x 22.5 x 0.5 cm 100 / 50 Print Code: F(1), W



01





SPECIAL LASER ENGRAVING MATCHING COLOUR

These notebooks with colour interior have an outer coating specially designed for laser engraving, which will ensure that your advertising or brand is perfectly engraved in the same colour as the inside of your chosen notebook.



03

100 Sheets
Lined

Kefron 6069

Notepad. PU. Hard Cover. 100 Sheets.
Notizblock. PU. Hardcover-Abdeckung. 100 Blätter.
Bloc Notes. Similicuir. Couverture Rigide. 100 Feuilles.
Notitieblokje. PU. Harde Kaft. 100 Blaadjes.

14.2 x 21.1 x 1.5 cm 50 / 25
 Print Code: E(1), L2, T, W

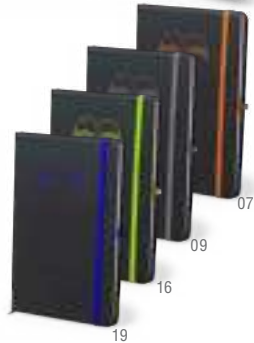

07

09

16

19



SPECIAL SUBLIMATION

New



03

100 Sheets
Plain

SUBLIMATION

Groly 20946

Sublimation Notepad. Polyester 600D RPET. Hard Cover. 100 Sheets.
Sublimations Notizblock. Polyester 600D RPET. Hardcover-Abdeckung. 100 Blätter.
Bloc Notes Sublimation. Polyester 600D RPET. Couverture Rigide. 100 Feuilles.
Sublimatie Notitieblokje. Polyester 600D RPET. Harde Kaft. 100 Blaadjes.

14.7 x 21 x 1.5 cm 50 / 25 Print Code: E(4), N(8), R

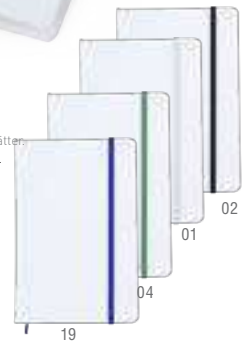

01

02

04

19

POCKET-SIZE



New

80 Sheets
Plain

Tierzo 21093

19

Noteпад. Cork/ PU. Hard Cover. 80 Sheets.
 Notizblock. Kork/ PU. Hardcover-Abdeckung. 80 Blätter.
 Bloc Notes. Liège/ Similicuir. Couverture Rigide. 80 Feuilles.
 Notitieblokje. Kurk/ PU. Harde Kaft. 80 Blaadjjes.

8,8 x 14 x 1,5 cm 100 / 50
 Print Code: E(1), L1



01

02

03

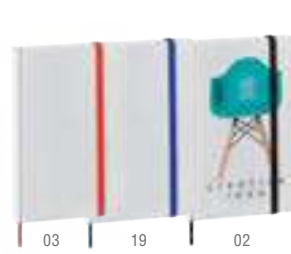

03

19

02



07

04

11

Yakis 4342



SUBLIMATION

Noteпад. Cardboard. Hard Cover. 80 Sheets.
 Notizblock. Papppe. Hardcover-Abdeckung. 80 Blätter.
 Bloc Notes. Carton. Couverture Rigide. 80 Feuilles.
 Notitieblokje. Karton. Harde Kaft. 80 Blaadjjes.

9 x 14 x 1,3 cm 100 / 50 Print Code: E(4), W, T

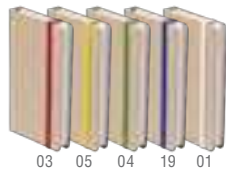
80 Sheets
Plain

03 05 04 19 01

100 Sheets
Plain

Bosco 5301

Noteпад. Recycled Cardboard. Hard Cover. 100 Sheets.
 Notizblock. Recycling Papppe. Hardcover-Abdeckung. 100 Blätter.
 Bloc Notes. Carton Recyclé. Couverture Rigide. 100 Feuilles.
 Notitieblokje. Gerecycled Karton. Harde Kaft. 100 Blaadjjes.

9,3 x 14,3 x 1,5 cm 100 / 50 Print Code: E(4), W

80 Sheets
Plain

Climer 5019

Noteпад. Cork. Hard Cover. 80 Sheets.
 Notizblock. Kork. Hardcover-Abdeckung. 80 Blätter.
 Bloc Notes. Liège. Couverture Rigide. 80 Feuilles.
 Notitieblokje. Kurk. Harde Kaft. 80 Blaadjjes.

8,9 x 14 x 1,4 cm 100 / 50 Print Code: E(1), L2, N(8), W

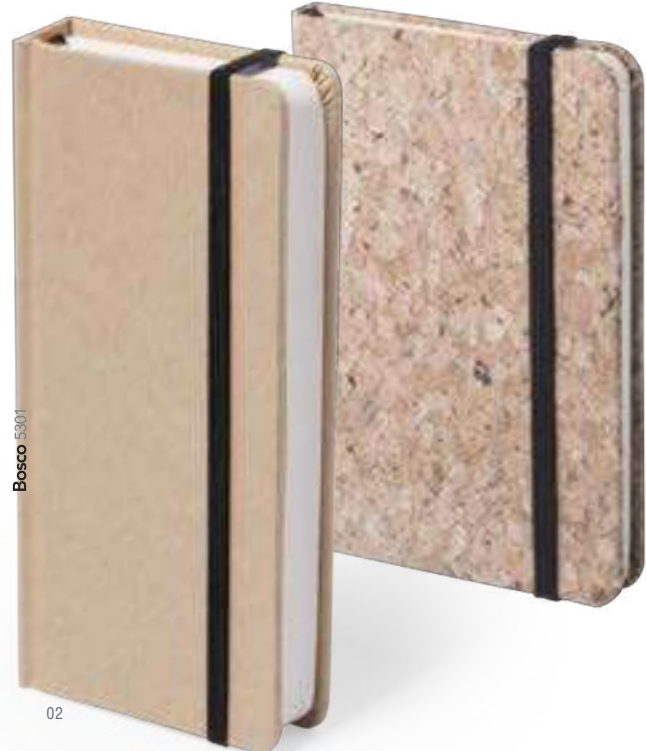

Bosco 5301

02

Climer 5019

POCKET-SIZE



NOTE THE IDEA!
RPET



Pushkin 20963

Notepad. Polyester 300D RPET. Hard Cover. 100 Sheets.
Notizblock. Polyester 300D RPET. Hardcover-Abdeckung. 100 Blätter.
Bloc Notes. Polyester 300D RPET. Couverture Rigide. 100 Feuilles.
Notitieblokje. Polyester 300D RPET. Harde Kaft. 100 Blaadjes.

9.3 x 14.3 x 1.5 cm 100 / 50
Print Code: E(1), N(8)



06

Kinelin 5299

Notepad. PU. Hard Cover. 100 Sheets.
Notizblock. PU. Hardcover-Abdeckung. 100 Blätter.
Bloc Notes. Similicuir. Couverture Rigide. 100 Feuilles.
Notitieblokje. PU. Harde Kaft. 100 Blaadjes.

9.3 x 14.3 x 1.5 cm 100 / 50
Print Code: E(4), T, W



Kine 3393

Notepad. PU. Hard Cover. 100 Sheets.
Notizblock. PU. Hardcover-Abdeckung. 100 Blätter.
Bloc Notes. Similicuir. Couverture Rigide. 100 Feuilles.
Notitieblokje. PU. Harde Kaft. 100 Blaadjes.

9.3 x 14.3 x 1.5 cm 100 / 50
Print Code: E(4), T, W



New



Webermax 21062

Set. Felt RPET/ Cork. Notepad Hard Cover. 80 Sheets. Pen Recycled Aluminium/ Cork. Jumbo Refill.

Set. Filz RPET/ Kork. Notizblock Hardcover-Abdeckung. 80 Blätter. Kugelschreiber Recycling Aluminium/ Kork. Jumbo Mine.

Set. Feutrine RPET/ Liège. Bloc Notes Couverture Rigide. 80 Feuilles. Stylo Aluminium Recyclé/ Liège. Recharge Jumbo.

Set. Vilt RPET/ Kurk. Nottieblokje Harde Kaft. 80 Blaadjes. Pen Gerecycled Aluminium/ Kurk. Jumbo Refill.

23.5 x 1.8 x 19 cm 30 / 15

Print Code: E(1), B(1), L1, L2, N(8)



80 Sheets
Plain



Minsor 6395

Set. Notepad Cork. Hard Cover. 80 Sheets. Pen Cork/ Wheat Straw/ ABS. Black Ink.

Set. Notizblock Kork. Hardcover-Abdeckung. 80 Blätter. Kugelschreiber Kork/ Weizenstroh/ ABS. Schwarze Tinte.

Set. Bloc Notes Liège. Couverture Rigide. 80 Feuilles. Stylo Liège/ Paille de Blé/ ABS. Encre Noire.

Set. Nottieblokje Kurk. Harde Kaft. 80 Blaadjes. Pen Kurk/ Tarvestro/ ABS. Zwarte Inkt.

23.5 x 1.8 x 19.5 cm 40 / 20

Print Code: E(1), B(1), L1, L2, N(8), W



80 Sheets
Plain



Hecan 6396

Set. Bamboo. Notebook Hard Cover. 80 Sheets. Pen Jumbo Refill. Black Ink.

Set. Bambus. Notizbuch Hardcover-Abdeckung. 80 Blätter. Kugelschreiber Jumbo Mine. Schwarze Tinte.

Set. Bamboe. Cahier Couverture Rigide. 80 Feuilles. Stylo Recharge Jumbo. Encre Noire.

Set. Bamboe. Nottiebokje Harde Kaft. 80 Blaadjes. Pen Jumbo Refill. Zwarte Inkt.

23.5 x 2 x 21.5 cm 40 / 20

Print Code: E(1), B(1)



80 Sheets
Lined



Patrick 21120

Set. Cork. Notepad Hard Cover. 80 Sheets. Pen. USB Memory 16GB.

Set. Kork. Notizblock Hardcover-Abdeckung. 80 Blätter. Kugelschreiber. USB Speicher 16GB.

Set. Liège. Bloc Notes Couverture Rigide. 80 Feuilles. Stylo. Clé USB 16GB.

Set. Kurk. Nottieblokje Harde Kaft. 80 Blaadjes. Pen. USB Memory 16GB.

26 x 3 x 21 cm 20

Print Code: E(1), B(1), L1, L2, N(8), W



80 Sheets
Lined



Marden 5041

Set. PU. Notepad Hard Cover. 100 Sheets. Pen Included.

Set. PU. Notizblock Hardcover-Abdeckung. 100 Blätter. Kugelschreiber Inklusive.

Set. Similticuir. Bloc Notes Couverture Rigide. 100 Feuilles. Stylo Incluse.

Set. PU. Nottieblokje Harde Kaft. 100 Blaadjes. Pen Inclusief.

24 x 2.2 x 19.7 cm 20

Print Code: E(1), B(1), L1, T, W

02

03

05

19

100 Sheets
Plain

Yazil 6397

Set. Notepad PU. Hard Cover. 80 Sheets. Roller Aluminium. Jumbo Refill.

Set. Notizblock PU. Hardcover-Abdeckung. 80 Blätter. Roller Pen Aluminium. Jumbo Mine.

Set. Bloc Notes Similticuir. Couverture Rigide. 80 Feuilles. Roller Aluminium. Recharge Jumbo.

Set. Nottieblokje PU. Harde Kaft. 80 Blaadjes. Roller Aluminium. Jumbo Refill.

23.5 x 1.8 x 19.5 cm 40 / 20

Print Code: E(1), B(1), L1, T, W



80 Sheets
Plain





Nauthax 1944

Set. Recycled Leather/ Metal. Notepad Hard Cover. 100 Sheets. Pen Included.

Set. Recycling Leder/ Metall. Notizblock Hardcover-Abdeckung. 100 Blätter. Kugelschreiber Inklusiv.

Set. Cuir Recyclé/ Métal. Bloc Notes Couverture Rigide. 100 Feuilles. Stylo Inclusie.

Set. Gerecycled Leer/ Staal. Notitieblokje Harde Kaft. 100 Blaadjes. Pen Inclusief.

24 x 19.5 x 1.8 cm 30 / 15 Print Code: E(1), B(1), L1



Wendam 1945

Set. Polyester 300D RPET/ Metal. Notepad Hard Cover. 100 Sheets. Pen Included.

Set. Polyester 300D RPET/ Metall. Notizblock Hardcover-Abdeckung. 100 Blätter. Kugelschreiber Inklusiv.

Set. Polyester 300D RPET/ Métal. Bloc Notes Couverture Rigide. 100 Feuilles. Stylo Inclusie.

Set. Polyester 300D RPET/ Staal. Notitieblokje Harde Kaft. 100 Blaadjes. Pen Inclusief.

23.5 x 1.4 x 19.5 cm 30 / 15 Print Code: E(1), B(1), L1, N(8)



ANTONIO MIRO



Nimaly 7379

Set. Polyester 300D/ Metal. Notepad Hard Cover. 100 Sheets. Pen.

Set. Polyester 300D/ Metall. Notizblock Hardcover-Abdeckung. 100 Blätter. Kugelschreiber.

Set. Polyester 300D/ Métal. Bloc Notes Couverture Rigide. 100 Feuilles. Stylo.

Set. Polyester 300D/ Staal. Notitieblokje Harde Kaft. 100 Blaadjes. Pen.

24 x 21.5 x 4 cm 20 / 10 Print Code: E(1), L1, N(8)

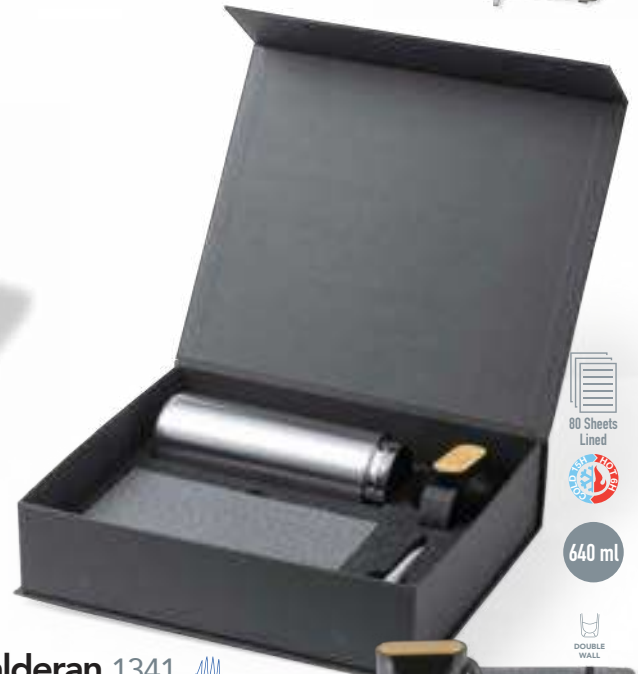

Halderan 1341

Set. Vacuum Flask Stainless Steel/ Bamboo, 640 ml. Notepad PU/ Bamboo, Hard Cover. 80 Sheets. Pen Aluminium/ Bamboo.

Set. Thermoskanne Rostfreier Stahl/ Bambus, 640 ml. Notizblock PU/ Bambus, Hardcover-Abdeckung. 80 Blätter. Kugelschreiber Aluminium/ Bambus.

Set. Thermo Acier Inox/ Bambou, 640 ml. Bloc Similicuir/ Bambou, Couverture Rigide. 80 Feuilles. Stylo Aluminium/ Bambou.

Set. Thermosfles Roestvrij Staal/ Bamboe, 640 ml. Notepad PU/ Bamboe, Harde Kaft. 80 Blaadjes. Pen Aluminium/ Bamboe.

32.5 x 8 x 27.6 cm 5

Print Code: F(1), L2



640 ml





50 Sheets
Lined

Sulax 6565

Notebook. Cork/ Recycled Cardboard. Hard Cover. 50 Sheets. Recycled Cardboard/ Wheat Straw/ ABS Pen Included.
Notizbuch. Kork/ Recycling Pappe. Hardcover-Abdeckung. 50 Blätter. Recycling Pappe/ Weizenstroh/ ABS Kugelschreiber Inklusiv.
Cahier. Liège/ Carton Recyclé. Couverture Rigide. 50 Feuilles. Stylo Carton Recyclé/ Paille de Blé/ ABS Inclusif.
Notitieboek. Kurk/ Gerecycled Karton. Harde Kaft. 50 Blaadjes. Pen Gerecycled Karton/ Tarwestro/ ABS Inclusief.

8.5 x 11.7 x 1.4 cm 200 / 50 Print Code: E(4), B(4), L2, N(B)



50 Sheets
Lined

Pilaf 4670

Notebook. Recycled Cardboard. Hard Cover. 50 Sheets. Recycled Cardboard Pen Included.
Notizbuch. Recycling Pappe. Hardcover-Abdeckung. 50 Blätter. Recycling Pappe Kugelschreiber Inklusiv.
Cahier. Carton Recyclé. Couverture Rigide. 50 Feuilles. Stylo Carton Recyclé Inclusif.
Notitieboek. Gerecycled Karton. Harde Kaft. 50 Blaadjes. Pen Gerecycled Karton Inclusief.

8.6 x 11.7 x 1.3 cm 200 / 50 Print Code: E(4), B(4)



03
05
02
19

01

Duxo 3216

Mini Notebook. PP. 60 Sheets. Pen Included.
Mini Notizbuch. PP. 60 Blätter. Kugelschreiber Inklusiv.
Mini Cahier. PP. 60 Feuilles. Stylo Inclusif.
Mini Notitieboek. PP. 60 Blaadjes. Pen Inclusief.

7 x 9.5 x 0.7 cm 300 / 50 Print Code: E(4), B(1)



70 Sheets
Lined

19 03 18 08

Rasmor 5991

Sticky Notepad. PU. 70 Sheets Notepad. 25 Sticky Notes 7,5 x 7,5 cm. 125 Mini Sticky Notes 1,2 x 4,5 cm. Recycled Cardboard Pen Included.
Notizblock. PU. 70 Blätter Notizblock. 25 Haftnotizen 7,5 x 7,5 cm. 125 Mini Haftnotizen 1,2 x 4,5 cm. Recycling Pappe Kugelschreiber Inklusiv.
Bloc Notes. Similicuir. Bloc 70 Feuilles. 25 Notes Adhésives 7,5 x 7,5 cm. 125 Mini Notes Adhésives 1,2 x 4,5 cm. Stylo Carton Recyclé Inclusif.
Plakmemo-Blokje. PU. 70 Blaadjes Notepad. 25 Plakmemo's 7,5 x 7,5 cm. 125 Mini Plakmemo's 1,2 x 4,5 cm. Pen Gerecycled Karton Inclusief.

10.5 x 15.5 x 2.3 cm 50 Print Code: E(1), B(4), L2

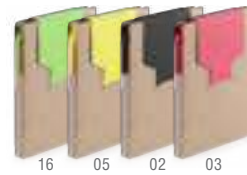

70 Sheets
Plain

16 05 02 03

Cravis 4887

Sticky Notepad. Recycled Cardboard. 70 Sheets Notepad. 25 Sticky Notes 7,6 x 9 cm. 25 Sticky Notes 3,8 x 6 cm. 100 Mini Sticky Notes 1,2 x 4,8 cm. Recycled Cardboard Pen Included.
Notizblock. Recycling Pappe. 70 Blätter Notizblock. 25 Haftnotizen 7,6 x 9 cm. 25 Haftnotizen 3,8 x 6 cm. 100 Mini Haftnotizen 1,2 x 4,8 cm. Recycling Pappe Kugelschreiber Inklusiv.
Bloc Notes. Carton Recyclé. Bloc 70 Feuilles. 25 Notes Adhésives 7,6 x 9 cm. 25 Notes Adhésives 3,8 x 6 cm. 100 Mini Notes Adhésives 1,2 x 4,8 cm. Stylo Carton Recyclé Inclusif.
Plakmemo-Blokje. Gerecycled Karton. 70 Blaadjes Notepad. 25 Plakmemo's 7,6 x 9 cm. 25 Plakmemo's 3,8 x 6 cm. 100 Mini Plakmemo's 1,2 x 4,8 cm. Pen Gerecycled Karton Inclusief.

10.2 x 14.2 x 1.3 cm 50 / 25 Print Code: E(4), B(4)



19



50 Sheets Lined

Diser 5670

Sticky Notepad, Recycled Cardboard, 50 Sheets, 15 Sticky Notes 4,4 x 7,5 cm, 75 Mini Sticky Notes 1,4 x 4,4 cm, Recycled Cardboard Pen Included.
 Haftender Notizblock, Recycling Pappe, 50 Blätter, 15 Haftnotizen 4,4 x 7,5 cm, 75 Mini Haftnotizen 1,4 x 4,4 cm, Recycling Pappe Kugelschreiber Inklusive.
 Bloc Notes Adhésif, Carton Recyclé, 50 Feuilles, 15 Notes Adhésives 4,4 x 7,5 cm, 75 Mini Notes Adhésives 1,4 x 4,4 cm, Stylo Carton Recyclé Inclusive.
 Notitieblok Zelfklevend, Gerecycled Karton, 50 Blaadjes, 15 Plakmemo's 4,4 x 7,5 cm, 75 Mini Plakmemo's 1,4 x 4,4 cm, Pen Gerecycled Karton Inclusief.

9.5 x 13.2 x 1.5 cm 200 / 50 Print Code: E(4), B(4)



70 Sheets Lined

Wombax 20965

Sticky Notepad, Recycled Cardboard, 70 Sheets Notepad, 15 Sticky Notes 6 x 6,5 cm, 75 Mini Sticky Notes 1,2 x 4,5 cm, Recycled Cardboard Pen Included.
 Notizblock, Recycling Pappe, 70 Blätter Notizblock, 15 Haftnotizen 6 x 6,5 cm, 75 Mini Haftnotizen 1,2 x 4,5 cm, Recycling Pappe Kugelschreiber Inklusive.
 Bloc Notes, Carton Recyclé, Bloc 70 Feuilles, 15 Notes Adhésives 6 x 6,5 cm, 75 Mini Notes Adhésives 1,2 x 4,5 cm, Stylo Carton Recyclé Inclusive.
 Plakmemo-Blokje, Gerecycled Karton, 70 Blaadjes Notepad, 15 Plakmemo's 6 x 6,5 cm, 75 Mini Plakmemo's 1,2 x 4,5 cm, Pen Gerecycled Karton Inclusief.

10.8 x 13.6 x 1 cm 100 / 25 Print Code: E(1), B(4)



HOLDER

Phesux 1892

Holder Sticky Notepad, Recycled Cardboard, 30 Sheets Notepad, 25 Sticky Notes 7,5 x 7,5 cm, 125 Mini Sticky Notes 1,2 x 4,5 cm, Recycled Cardboard Pen Included.
 Halter Notizblock, Recycling Pappe, 30 Blätter Notizblock, 25 Haftnotizen 7,5 x 7,5 cm, 125 Mini Haftnotizen 1,2 x 4,5 cm, Recycling Pappe Kugelschreiber Inklusive.
 Bloc Notes Support, Carton Recyclé, Bloc 30 Feuilles, 25 Notes Adhésives 7,5 x 7,5 cm, 125 Mini Notes Adhésives 1,2 x 4,5 cm, Stylo Carton Recyclé Inclusive.

Houder Plakmemo-Blokje, Gerecycled Karton, 30 Blaadjes Notepad, 25 Plakmemo's 7,5 x 7,5 cm, 125 Mini Plakmemo's 1,2 x 4,5 cm, Pen Gerecycled Karton Inclusief.

10.5 x 16 x 1.5 cm 100 / 50 Print Code: E(1), B(4)



30 Sheets Lined



Estein 20966

Sticky Notepad, Recycled Cardboard, 70 Sheets, 25 Sticky Notes 4,5 x 5 cm, 125 Mini Sticky Notes 1,5 x 5 cm.
 Haftender Notizblock, Recycling Pappe, 70 Blätter, 25 Haftnotizen 4,5 x 5 cm, 125 Mini Haftnotizen 1,5 x 5 cm.
 Bloc Notes Adhésif, Carton Recyclé, 70 Feuilles, 25 Notes Adhésives 4,5 x 5 cm, 125 Mini Notes Adhésives 1,5 x 5 cm.

Notitieblok Zelfklevend, Gerecycled Karton, 70 Blaadjes, 25 Plakmemo's 4,5 x 5 cm, 125 Mini Plakmemo's 1,5 x 5 cm.

13 x 8.8 x 1.1 cm 100 / 25 Print Code: E(1)



New



70 Sheets Lined



Aurat 20218

Sticky Notepad. Felt RPET. 30 Sheets Notepad. 25 Sticky Notes 4,5 x 4,5 cm. 125 Mini Sticky Notes 1,2 x 4,5 cm.
 Notizblock. Filz RPET. 30 Blätter Notizblock. 25 Haftnotizen 4,5 x 4,5 cm. 125 Mini Haftnotizen 1,2 x 4,5 cm.
 Bloc Notes. Feutrine RPET. Bloc 30 Feuilles. 25 Notes Adhésives 4,5 x 4,5 cm. 125 Mini Notes Adhésives 1,2 x 4,5 cm.
 Plakmemo-Blokje. Vilt RPET. 30 Blaadjes Notepad. 25 Plakmemo's 4,5 x 4,5 cm. 125 Mini Plakmemos 1,2 x 4,5 cm.

📏 6 x 13 x 1 cm 📦 200 / 50 🖨️ Print Code: C(1), N(8)

Sorduk 20233

Sticky Notepad. Wheat Straw/ PP. 30 Sheets Notepad. 25 Sticky Notes 4,5 x 4,4 cm. 125 Mini Sticky Notes 1,5 x 4,3 cm.
 Notizblock. Weizenstroh/ PP. 30 Blätter Notizblock. 25 Haftnotizen 4,5 x 4,4 cm. 125 Mini Haftnotizen 1,5 x 4,3 cm.
 Bloc Notes. Paille de Blé/ PP. Bloc 30 Feuilles. 25 Notes Adhésives 4,5 x 4,4 cm. 125 Mini Notes Adhésives 1,5 x 4,3 cm.
 Plakmemo-Blokje. Tarwestro/ PP. 30 Blaadjes Notepad. 25 Plakmemo's 4,5 x 4,4 cm. 125 Mini Plakmemos 1,5 x 4,3 cm.

📏 6 x 13 x 1 cm 📦 200 / 50 🖨️ Print Code: B(4)



Dosan 5667

Sticky Notepad. Recycled Cardboard. 100 Sticky Notes 5,5 x 9,5 cm. 25 Sticky Notes 5 x 7,6 cm. 125 Mini Sticky Notes 1,2 x 4,9 cm.

Notizblock. Recycling Pappe. 100 Haftnotizen 5,5 x 9,5 cm. 25 Haftnotizen 5 x 7,6 cm. 125 Mini Haftnotizen 1,2 x 4,9 cm.

Bloc Notes. Carton Recyclé. 100 Notes Adhésives 5,5 x 9,5 cm. 25 Notes Adhésives 5 x 7,6 cm. 125 Mini Notes Adhésives 1,2 x 4,9 cm.

Plakmemo-Blokje. Gerecycled Karton. 100 Plakmemo's 5,5 x 9,5 cm. 25 Plakmemo's 5 x 7,6 cm. 125 Mini Plakmemos 1,2 x 4,9 cm.

📏 8 x 10,9 x 1,8 cm 📦 100 / 50 🖨️ Print Code: D(4), W



Alisio 20915

Office Set. Recycled Cardboard. 220 Sticky Notes 4 x 4,5 cm. 550 Mini Sticky Notes 1,2 x 4,5 cm. Ruler 12 cm. Recycled Cardboard Pen.
 Büro-Set. Recycling Pappe. 220 Haftnotizen 4 x 4,5 cm. 550 Mini Haftnotizen 1,2 x 4,5 cm. Lineal 12 cm. Recycling Pappe Kugelschreiber.

Set de Bureau. Carton Recyclé. 220 Notes Adhésives 4 x 4,5 cm. 550 Mini Notes Adhésives 1,2 x 4,5 cm. Règle 12 cm. Stylo Carton Recyclé.

Kantoorset. Gerecycled Karton. 220 Plakmemo's 4 x 4,5 cm. 550 Mini Plakmemo's 1,2 x 4,5 cm. Liniaal 12 cm. Pen Gerecycled Karton.

📏 16 x 2,3 x 6,5 cm 📦 100 / 50 🖨️ Print Code: E(1), B(1)



Kendil 6543

Sticky Notepad. Recycled Cardboard. 60 Sheets Notepad. 25 Sticky Notes 5 x 7,5 cm. 125 Mini Sticky Notes 1,5 x 5 cm. Recycled Cardboard Pen Included.

Notizblock. Recycling Pappe. 60 Blätter Notizblock. 25 Haftnotizen 5 x 7,5 cm. 125 Mini Haftnotizen 1,5 x 5 cm. Recycling Pappe Kugelschreiber Inklusiv.

Bloc Notes. Carton Recyclé. Bloc 60 Feuilles. 25 Notes Adhésives 5 x 7,5 cm. 125 Mini Notes Adhésives 1,5 x 5 cm. Stylo Carton Recyclé Inclusive.

Plakmemo-Blokje. Gerecycled Karton. 60 Blaadjes Notepad. 25 Plakmemo's 5 x 7,5 cm. 125 Mini Plakmemo's 1,5 x 5 cm. Pen Gerecycled Karton Inclusief.

📏 11,8 x 19 x 1,6 cm 📦 50 / 25 🖨️ Print Code: E(4), B(4)





Karlen 4889

Sticky Notepad. Cardboard. 40 Sticky Notes 2,5 x 4,3 cm. 100 Mini Sticky Notes 1,2 x 4,3 cm.
 Notizblock. Pappe. 40 Haftnotizen 2,5 x 4,3 cm. 100 Mini Haftnotizen 1,2 x 4,3 cm.
 Bloc Notes. Carton. 40 Notes Adhésives 2,5 x 4,3 cm. 100 Mini Notes Adhésives 1,2 x 4,3 cm.
 Plakmemo-Blokje. Karton. 40 Plakmemo's 2,5 x 4,3 cm. 100 Mini Plakmemo's 1,2 x 4,3 cm.

11.3 x 5 x 0.3 cm 500 / 50 Print Code: B(4)



Lazza 5668

Sticky Notepad. Recycled Cardboard. 100 Sticky Notes 5,1 x 7,5 cm. 125 Mini Sticky Notes 1,5 x 5,1 cm.
 Notizblock. Recycling Pappe. 100 Haftnotizen 5,1 x 7,5 cm. 125 Mini Haftnotizen 1,5 x 5,1 cm.
 Bloc Notes. Carton Recyclé. 100 Notes Adhésives 5,1 x 7,5 cm. 125 Mini Notes Adhésives 1,5 x 5,1 cm.
 Plakmemo-Blokje. Gerecycled Karton. 100 Plakmemo's 5,1 x 7,5 cm. 125 Mini Plakmemo's 1,5 x 5,1 cm.

10.8 x 8.5 x 2.5 cm 100 / 50 Print Code: D(4)



Kuaid 20921

Notepad. Recycled Cardboard. 225 Mini Sticky Notes.
 Notizzettelbox. Recycling Pappe. 225 Mini Haftnotizen.
 Porte Notes. Carton Recyclé. 225 Mini Notes Adhésives.
 Plakmemohouder. Gerecycled Karton. 225 Mini Plakmemo's.

9 x 1.6 x 7.5 cm 100 / 50 Print Code: B(1)



Blasco 6400

Ruler Bookmark. Recycled Cardboard. 13 cm and 5". 15 Sticky Notes 4 x 4,5 cm. 75 Mini Sticky Notes 1,2 x 4,5 cm.
 Lineal Lesezeichen. Recycling Pappe. 13 cm und 5". 15 Haftnotizen 4 x 4,45 cm. 75 Mini Haftnotizen 1,2 x 4,5 cm.
 Règle Marque Pages. Carton Recyclé. 13 cm et 5". 15 Notes Adhésives 4 x 4,5 cm. 75 Mini Notes Adhésives 1,2 x 4,5 cm.
 Lijniaal Bladwijzer. Gerecycled Karton. 13 cm en 5". 15 Plakmemo's 4 x 4,5 cm. 75 Mini Plakmemo's 1,2 x 4,5 cm.

6 x 21.5 cm 500 / 100 Print Code: B(4)



Zinko 3142

Sticky Notepad. Recycled Cardboard. 100 Sticky Notes 1,5 x 5 cm.
 Notizblock. Recycling Pappe. 100 Haftnotizen 1,5 x 5 cm.
 Bloc Notes. Carton Recyclé. 100 Notes Adhésives 1,5 x 5 cm.
 Plakmemo-Blokje. Gerecycled Karton. 100 Plakmemo's 1,5 x 5 cm.

8.2 x 6 x 0.3 cm 500 / 25 Print Code: B(4)



Laska 4859

Sticky Notepad. Recycled Cardboard. 75 Sticky Notes 5 x 7,5 cm. 125 Mini Sticky Notes 1,5 x 5 cm.
 Notizblock. Recycling Pappe. 75 Haftnotizen 5 x 7,5 cm. 125 Mini Haftnotizen 1,5 x 5 cm.
 Bloc Notes. Carton Recyclé. 75 Notes Adhésives 5 x 7,5 cm. 125 Mini Notes Adhésives 1,5 x 5 cm.
 Plakmemo-Blokje. Gerecycled Karton. 75 Plakmemo's 5 x 7,5 cm. 125 Mini Plakmemos 1,5 x 5 cm.

8.3 x 7.6 x 2.2 cm 100 / 50 Print Code: D(4)



Albot 20948

Seeds Sticky Notepad. Seed Paper: 25 Sticky Notes 5 x 7,5 cm. 125 Mini Sticky Notes 1,5 x 5 cm. Petunia Seeds Included. Assorted Coloured Flowers.
 Samen Notizblock. Samenpapier: 25 Haftnotizen 5 x 7,5 cm. 125 Mini Haftnotizen 1,5 x 5 cm. Petuniensamen Inklusive. In verschiedenen Farben.
 Bloc Notes Ensemencé. Papier Ensemencé. 25 Notes Adhésives 5 x 7,5 cm. 125 Mini Notes Adhésives 1,5 x 5 cm. Graines de Pétunia Incluses. Fleurs Couleurs Diverses.
 Zaad Plakmemo-Blokje. Zaadpapier: 25 Plakmemo's 5 x 7,5 cm. 125 Mini Plakmemo's 1,5 x 5 cm. Petunia Zaden Inclusief. Assortiment van Gekleurde Bloemen.

6.2 x 8.5 x 0.9 cm 500 / 100 Print Code: B(4)

Amenti 1885

Seeds Sticky Notepad. Seed Paper: 10 Sticky Notes 3 x 5 cm. 30 Mini Sticky Notes 1,5 x 5 cm. Petunia Seeds Included. Assorted Coloured Flowers.
 Samen Notizblock. Samenpapier: 10 Haftnotizen 3 x 5 cm. 30 Mini Haftnotizen 1,5 x 5 cm. Petuniensamen Inklusive. In verschiedenen Farben.
 Bloc Notes Ensemencé. Papier Ensemencé. 10 Notes Adhésives 3 x 5 cm. 30 Mini Notes Adhésives 1,5 x 5 cm. Graines de Pétunia Incluses. Fleurs Couleurs Diverses.
 Zaad Plakmemo-Blokje. Zaadpapier: 10 Plakmemo's 3 x 5 cm. 30 Mini Plakmemo's 1,5 x 5 cm. Petunia Zaden Inclusief. Assortiment van Gekleurde Bloemen.

8.5 x 5.5 x 0.2 cm 500 / 100 Print Code: B(4)



Kich 20947

Seeds Bookmark. Seed Paper: 15 Sticky Notes 4 x 4,5 cm. 75 Mini Sticky Notes 1,2 x 4,5 cm. Petunia Seeds Included. Assorted Coloured Flowers.
 Samen Lesezeichen. Samenpapier: 15 Haftnotizen 4 x 4,45 cm. 75 Mini Haftnotizen 1,2 x 4,5 cm. Petuniensamen Inklusive. In verschiedenen Farben.
 Marque Pages Ensemencé. Papier Ensemencé. 15 Notes Adhésives 4 x 4,5 cm. 75 Mini Notes Adhésives 1,2 x 4,5 cm. Graines de Pétunia Incluses. Fleurs Couleurs Diverses.
 Zaad Bladwijzer. Zaadpapier: 15 Plakmemo's 4 x 4,5 cm. 75 Mini Plakmemo's 1,2 x 4,5 cm. Petunia Zaden Inclusief. Assortiment van Gekleurde Bloemen.

6 x 21.5 cm 500 / 100 Print Code: B(4)

Zomek 1886

Seeds Sticky Notepad. Seed Paper: 50 Sticky Notes 7 x 10 cm. Petunia Seeds Included. Assorted Coloured Flowers.
 Samen Notizblock. Samenpapier: 50 Haftnotizen 7 x 10 cm. Petuniensamen Inklusive. In verschiedenen Farben.
 Bloc Notes Ensemencé. Papier Ensemencé. 50 Notes Adhésives 7 x 10 cm. Graines de Pétunia Incluses. Fleurs Couleurs Diverses.
 Zaad Plakmemo-Blokje. Zaadpapier: 50 Plakmemo's 7 x 10 cm. Petunia Zaden Inclusief. Assortiment van Gekleurde Bloemen.

10 x 7.5 x 0.5 cm 200 / 25 Print Code: D(4)



Mikonen 20968

Office Set. Bamboo. 220 Sticky Notes 4 x 4,5 cm. 550 Mini Sticky Notes 1,2 x 4,5 cm. Ruler 12 cm. Recycled Cardboard Pen.

Büro-Set. Bambus. 220 Haftnotizen 4 x 4,5 cm. 550 Mini Haftnotizen 1,2 x 4,5 cm. Lineal 12 cm. Recycling Pappe Kugelschreiber.

Set de Bureau. Bamboo. 220 Notes Adhésives 4 x 4,5 cm. 550 Mini Notes Adhésives 1,2 x 4,5 cm. Règle 12 cm. Stylo Carton Recyclé.

Kantoorset. Bamboe. 220 Plakmemo's 4 x 4,5 cm. 550 Mini Plakmemo's 1,2 x 4,5 cm. Liniaal 12 cm. Pen Gerecycled Karton.

16 x 2,3 x 6,5 cm 100 / 50 Print Code: E(1), B(4), L2



Oresten 20964

Sticky Notepad. Bamboo. 70 Sheets. 25 Sticky Notes 5 x 7,5 cm. 125 Mini Sticky Notes 1,2 x 4,5 cm. Haftender Notizblock. Bambus. 70 Blätter. 25 Haftnotizen 5 x 7,5 cm. 125 Mini Haftnotizen 1,2 x 4,5 cm. Bloc Notes Adhésif. Bamboo. 70 Feuilles. 25 Notes Adhésives 5 x 7,5 cm. 125 Mini Notes Adhésives 1,2 x 4,5 cm. Notitieblok Zelfklevend. Bamboe. 70 Blaadjes. 25 Plakmemo's 5 x 7,5 cm. 125 Mini Plakmemo's 1,2 x 4,5 cm.

8,4 x 10,5 x 1,4 cm 200 / 100 Print Code: E(4), L1

BAMBOO



Feros 1292

Sticky Notepad. Bamboo. 75 Sticky Notes 5 x 7 cm. 125 Mini Sticky Notes 1,5 x 5 cm. Notizblock. Bambus. 75 Haftnotizen 5 x 7 cm. 125 Mini Haftnotizen 1,5 x 5 cm.

Bloc Notes. Bamboo. 75 Notes Adhésives 5 x 7 cm. 125 Mini Notes Adhésives 1,5 x 5 cm. Plakmemo-Blokje. Bamboe. 75 Plakmemo's 5 x 7 cm. 125 Mini Plakmemos 1,5 x 5 cm.

7,3 x 8,7 x 2,5 cm 200 / 100 Print Code: D(4)



Mabur 20967

Sticky Notepad. Bamboo. 100 Sticky Notes 5 x 7,5 cm. 125 Mini Sticky Notes 1,5 x 5 cm. Haftender Notizblock. Bambus. 100 Haftnotizen 5 x 7,5 cm. 125 Mini Haftnotizen 1,5 x 5 cm. Bloc Notes Adhésif. Bamboo. 100 Notes Adhésives 5 x 7,5 cm. 125 Mini Notes Adhésives 1,5 x 5 cm. Notitieblok Zelfklevend. Bamboe. 100 Plakmemo's 5 x 7,5 cm. 125 Mini Plakmemo's 1,5 x 5 cm.

8,5 x 10,8 x 2,5 cm 100 / 50 Print Code: D(4)

BAMBOO



Kokil 1273

Notepad. Bamboe. 115 Sticky Notes 6,5 x 9,5 cm. 115 Mini Sticky Notes 4 x 5 cm. 420 Mini Sticky Notes 1,2 x 4,2 cm.
 Notizzettelbox. Bamboe. 115 Haftnotizen 6,5 x 9,5 cm. 115 Mini Haftnotizen 4 x 5 cm. 420 Mini Haftnotizen 1,2 x 4,2 cm.
 Porte Notes. Bamboe. 115 Notes Adhésives 6,5 x 9,5 cm. 115 Mini Notes Adhésives 4 x 5 cm. 420 Mini Notes Adhésives 1,2 x 4,2 cm.
 Plakmemohouder. Bamboe. 115 Plakmemo's 6,5 x 9,5 cm. 115 Mini Plakmemo's 4 x 5 cm. 420 Mini Plakmemo's 1,2 x 4,2 cm.

12 x 2 x 10,6 cm 80 / 40 Print Code: E(2)



Heinda 1878

Notepad Holder. Bamboe. 80 Sticky Notes 5,5 x 8,2 cm.
 Halter Notizzettelbox. Bamboe. 80 Haftnotizen 5,5 x 8,2 cm.
 Porte Notes Support. Bamboe. 80 Notes Adhésives 5,5 x 8,2 cm.
 Houder Plakmemohouder. Bamboe. 80 Plakmemo's 5,5 x 8,2 cm.

11,8 x 1,9 x 7 cm 100 / 50 Print Code: D(4), L1



Yiuta 1884

Notepad. Bamboe. 80 Sheets 2,9 x 5,9 cm.
 Notizzettelbox. Bamboe. 80 Blätter 2,9 x 5,9 cm.
 Porte Notes. Bamboe. 80 Feuilles 2,9 x 5,9 cm.
 Plakmemohouder. Bamboe. 80 Blaadjes 2,9 x 5,9 cm.

3 x 6 x 1,3 cm 500 / 50 Print Code: C(4), L1

Tecin 1295

Ruler Bookmark. Bamboe. 13 cm and 5". 25 Sticky Notes 4 x 4,5 cm. 125 Mini Sticky Notes 1,2 x 4,5 cm.
 Lineal Lesezeichen. Bamboe. 13 cm und 5". 25 Haftnotizen 4 x 4,45 cm. 125 Mini Haftnotizen 1,2 x 4,5 cm.
 Règle Marque Pages. Bamboe. 13 cm et 5". 25 Notes Adhésives 4 x 4,5 cm. 125 Mini Notes Adhésives 1,2 x 4,5 cm.
 Lijniaal Bladwijzer. Bamboe. 13 cm en 5". 25 Plakmemo's 4 x 4,5 cm. 125 Mini Plakmemo's 1,2 x 4,5 cm.

6 x 21,5 cm 500 / 250 Print Code: B(4)



01

Codex 3805

Notepad. Cardboard. 200 Sheets 7,6 x 7,6 cm. 125 Mini Sticky Notes 1,5 x 5 cm.
 Notizzettelbox. Pappe. 200 Blätter 7,6 x 7,6 cm. 125 Mini Haftnotizen 1,5 x 5 cm.
 Porte Notes. Carton. 200 Feuilles 7,6 x 7,6 cm. 125 Mini Notes Adhésives 1,5 x 5 cm.
 Plakmemohouder. Karton. 200 Blaadjes 7,6 x 7,6 cm. 125 Mini Plakmemo's 1,5 x 5 cm.

8 x 2,6 x 8 cm 100 / 50 Print Code: D(4)

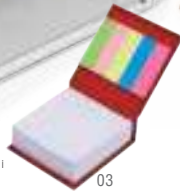

03

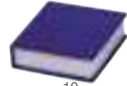

19



02

Leryl 6471

Notepad. Recycled Cardboard. 200 Sheets 7,5 x 8 cm. 125 Mini Sticky Notes 1,5 x 5 cm.
 Notizzettelbox. Recycling Pappe. 200 Blätter 7,5 x 8 cm. 125 Mini Haftnotizen 1,5 x 5 cm.
 Porte Notes. Carton Recyclé. 200 Feuilles 7,5 x 8 cm. 125 Mini Notes Adhésives 1,5 x 5 cm.
 Plakmemohouder. Gerecycled Karton. 200 Blaadjes 7,5 x 8 cm. 125 Mini Plakmemo's 1,5 x 5 cm.

8,1 x 2,6 x 8,3 cm 100 / 50 Print Code: D(4)



Vidmar 20937

Notepad. Recycled Milk Cartons. 200 Sheets 7,5 x 8 cm.
 Notizzettelbox. Recyclete Milchkartons. 200 Blätter 7,5 x 8 cm.
 Porte Notes. Cartons de Lait Recyclés. 200 Feuilles 7,5 x 8 cm.
 Plakmemohouder. Gerecycleerde Melkpakken. 200 Blaadjes 7,5 x 8 cm.

7,7 x 2,5 x 8 cm 100 / 50 Print Code: D(4)

MADE FROM
 -RECYCLED-
 MILK CARTON



Zicky 2722

Notepad. Recycled Cardboard. 370 Sheets 6,6 x 6,6 cm.
 Notizzettelbox. Recycling Pappe. 370 Blätter 6,6 x 6,6 cm.
 Porte Notes. Carton Recyclé. 370 Feuilles 6,6 x 6,6 cm.
 Plakmemohouder. Gerecycled Karton. 370 Blaadjes 6,6 x 6,6 cm.

7 x 3,5 x 7 cm 100 Print Code: D(1)



Hibon 2723

Notepad. Wood. 300 Sheets 7,3 x 11,5 cm.
 Notizzettelbox. Holz. 300 Blätter 7,3 x 11,5 cm.
 Porte Notes. Bois. 300 Feuilles 7,3 x 11,5 cm.
 Plakmemohouder. Hout. 300 Blaadjes 7,3 x 11,5 cm.

11,5 x 4,7 x 7,3 cm 50 Print Code: D(1)



Arolax 20920

Notepad Pencil Holder. Recycled Cardboard. 320 Sheets 7,5 x 7,5 cm. 125 Mini Sticky Notes 1,2 x 4,5 cm.
 Notizzettelbox Stifthalter. Recycling Pappe. 320 Blätter 7,5 x 7,5 cm. 125 Mini Haftnotizen 1,2 x 4,5 cm.
 Porte-Crayons Porte Notes. Carton Recyclé. 320 Feuilles 7,5 x 7,5 cm. 125 Mini Notes Adhésives 1,2 x 4,5 cm.
 Plakmemohouder Pennenbakje. Gerecycled Karton. 320 Blaadjes 7,5 x 7,5 cm. 125 Mini Plakmemo's 1,2 x 4,5 cm.

8 x 7,5 x 8 cm 50 / 25 Print Code: D(1), W



Marquez 21061

Multifunction Pencil Holder. Recycled Cardboard. Photos Size: 5 x 8 cm. 25 Sticky Notes 7,5 x 7,5 cm. 125 Mini Sticky Notes 1,2 x 4,5 cm.
 Multifunktioel Stifthalter. Recycling Pappe. Photos: 5 x 8 cm. 25 Haftnotizen 7,5 x 7,5 cm. 125 Mini Haftnotizen 1,2 x 4,5 cm.
 Porte-Crayons Multifonction. Carton Recyclé. Photos: 5 x 8 cm. 25 Notes Adhésives 7,5 x 7,5 cm. 125 Mini Notes Adhésives 1,2 x 4,5 cm.
 Multifunctioneel Pennenbakje. Gerecycled Karton. Foto's Maa: 5 x 8 cm. 25 Plakmemo's 1,2 x 4,5 cm. 125 Mini Plakmemo's 1,2 x 4,5 cm.

13,6 x 9,5 x 13,9 cm 80 / 20 Print Code: D(1)



New

PHOTO NOT INCLUDED

05

URBAN LIFESTYLE & LEISURE





**STYLISH,
VERSATILE,
PRACTICAL**

RNYLON



Polack 1845



Backpack. Nylon Recycled 420D. Padded Laptop Compartment. Padded Back and Shoulder Straps.
 Rucksack. Recycling Nylon 420D. Gepolsterte Laptotasche. Gepolsterter Rücken und Schultergurte.
 Sac à Dos. Nylon Recyclé 420D. Pochette Rembourrée pour Portable. Dos et Bretelles Rembourrées.
 Rugzak. Gerecycled Nylon 420D. Gewatteerd Laptop Compartment. Gewatteerde Achterzijde en Schouderbanden.

32 x 42 x 15 cm 30 Print Code: G(1), N(8)

Luffin 1844



Backpack. Nylon Recycled 420D. Padded Laptop Compartment. Padded Back and Shoulder Straps.
 Rucksack. Recycling Nylon 420D. Gepolsterte Laptotasche. Gepolsterter Rücken und Schultergurte.
 Sac à Dos. Nylon Recyclé 420D. Pochette Rembourrée pour Portable. Dos et Bretelles Rembourrées.
 Rugzak. Gerecycled Nylon 420D. Gewatteerd Laptop Compartment. Gewatteerde Achterzijde en Schouderbanden.

32.5 x 44 x 25 cm 20 Print Code: G(1), N(8)

New



Bogart 20884

Backpack. Polyester 600D RPET. Padded Back and Shoulder Straps.
 Rucksack. Polyester 600D RPET. Gepolsterter Rücken und Schultergurte.
 Sac à Dos. Polyester 600D RPET. Dos et Bretelles Rembourrées.
 Ruzgak. Polyester 600D RPET. Gewatteerde Achterzijde en Schouderbanden.

 32 x 43 x 21.5 cm  20  Print Code: G(1), N(8)

New



Amurax 20883

Backpack. Polyester 600D RPET. Padded Laptop and Tablet Compartment. Padded Back and Shoulder Straps.
 Rucksack. Polyester 600D RPET. Gepolsterter Laptoptasche und Tablet. Gepolsterter Rücken und Schultergurte.
 Sac à Dos. Polyester 600D RPET. Pochette Rembourrée pour Portable et Tablette. Dos et Bretelles Rembourrées.
 Ruzgak. Polyester 600D RPET. Gewatteerd Laptop en Tablet Compartment. Gewatteerde Achterzijde en Schouderbanden.



 30 x 45 x 14 cm  20  Print Code: G(1), N(8)

New



Weiter 20881

Backpack. Polyester 300D RPET. Extendable. Padded Laptop and Tablet Compartment. Padded Back and Shoulder Straps.
 Rucksack. Polyester 300D RPET. Ausziehbar. Gepolsterter Laptoptasche und Tablet. Gepolsterter Rücken und Schultergurte.
 Sac à Dos. Polyester 300D RPET. Extensible. Pochette Rembourrée pour Portable et Tablette. Dos et Bretelles Rembourrées.
 Ruzgak. Polyester 300D RPET. Verlangbaar. Gewatteerd Laptop en Tablet Compartment. Gewatteerde Achterzijde en Schouderbanden.

 31.5 x 42 x 16 cm  20  Print Code: G(1), N(8)





New



Ingria 20882

Backpack. Polyester 600D RPET. Padded Laptop and Tablet Compartment. Padded Back and Shoulder Straps.
 Rucksack. Polyester 600D RPET. Gepolsterter Laptoptasche und Tablet. Gepolsterter Rücken und Schultergurte.
 Sac à Dos. Polyester 600D RPET. Pochette Rembourrée pour Portable et Tablette. Dos et Bretelles Rembourrées.
 Ruzgak. Polyester 600D RPET. Gewatteerd Laptop en Tablet Compartment. Gewatteerde Achterzijde en Schouderbanden.

 31 x 42 x 12 cm  20  Print Code: N(8)



RPET 

02

10"
TABLET
COMPARTMENT15"
LAPTOP
COMPARTMENT**Konor 6451**

Backpack. Polyester 600D RPET. USB Connection. Padded Laptop and Tablet Compartment. Padded Back and Shoulder Straps.

Rucksack. Polyester 600D RPET. USB Anschluss. Gepolsterte Laptoptasche und Tablet. Gepolsterter Rücken und Schultergurte.

Sac à Dos. Polyester 600D RPET. Connexion USB. Pochette Rembourrée pour Portable et Tablette. Dos et Bretelles Rembourrées.

Rugzak. Polyester 600D RPET. USB Verbinding. Gewatteerd Laptop en Tablet Compartment. Gewatteerde Achterzijde en Schouderbanden.

 29 x 43 x 13 cm  20  Print Code: G(1), N(8)

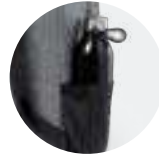

08

TROLLEY
STRAP12"
TABLET
COMPARTMENT15"
LAPTOP
COMPARTMENT**Bulman 6848**

Anti-Theft Backpack. Polyester 600D RPET. Padded. Padded Laptop and Tablet Compartment.

Anti-Diebstahl Rucksack. Polyester 600D RPET. Gepolstert. Gepolsterte Laptoptasche und Tablet.

Sac à Dos Antivol. Polyester 600D RPET. Rembourré. Pochette Rembourrée pour Portable et Tablette.

Anti-Diefstal Rugzak. Polyester 600D RPET. Gewatteerd. Gewatteerd Laptop en Tablet Compartment.

 35 x 47 x 15 cm  20  Print Code: G(1), E(1)

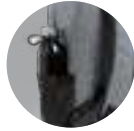
10"
TABLET
COMPARTMENT15"
LAPTOP
COMPARTMENT**Terrex 6749**

Backpack. Polyester 600D RPET. Padded. Padded Laptop and Tablet Compartment.

Rucksack. Polyester 600D RPET. Gepolstert. Gepolsterte Laptoptasche und Tablet.

Sac à Dos. Polyester 600D RPET. Rembourré. Pochette Rembourrée pour Portable et Tablette.

Rugzak. Polyester 600D RPET. Gewatteerd. Gewatteerd Laptop en Tablet Compartment.

 31 x 45 x 13 cm  20  Print Code: G(1), N(8), O



**Caldy 6452**

Backpack. Polyester 600D RPET. Padded Back and Shoulder Straps.

Rucksack. Polyester 600D RPET. Gepolsterter Rücken und Schultergurte.

Sac à Dos. Polyester 600D RPET. Dos et Bretelles Rembourrées.

Rugzak. Polyester 600D RPET. Gewatteerde Achterzijde en Schouderbanden.

 28 x 38 x 12 cm  40  Print Code: G(1), N(8), O, P



08

02



08



02



06

Elanis 1472

Backpack. Polyester 600D RPET. Padded. Padded Laptop and Tablet Compartment. Padded Back and Shoulder Straps.
Rucksack. Polyester 600D RPET. Gepolstert. Gepolsterte Laptotasche und Tablet. Gepolsterter Rücken und Schultergurte.

Sac à Dos. Polyester 600D RPET. Rembourré. Pochette Rembourrée pour Portable et Tablette. Dos et Bretelles Rembourrées.

Rugzak. Polyester 600D RPET. Gewatteerd. Gewatteerd Laptop en Tablet Compartment. Gewatteerde Achterzijde en Schouderbanden.

 29 x 44 x 17 cm  20  Print Code: G(1), N(8)



TABLET COMPARTMENT



LAPTOP COMPARTMENT



TROLLEY STRAP

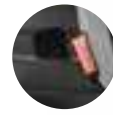

08



02



06

Danium 6909

Anti-Theft Backpack. Polyester 300D RPET. Padded. Padded Laptop and Tablet Compartment.

Anti-Diebstahl Rucksack. Polyester 300D RPET. Gepolstert. Gepolsterte Laptotasche und Tablet.

Sac à Dos Antivol. Polyester 300D RPET. Rembourré. Pochette Rembourrée pour Portable et Tablette.

Anti-Diefstal Rugzak. Polyester 300D RPET. Gewatteerd. Gewatteerd Laptop en Tablet Compartment.

 32 x 42 x 12 cm  10  Print Code: N(8)



TABLET COMPARTMENT



LAPTOP COMPARTMENT



TROLLEY STRAP



TABLET COMPARTMENT



LAPTOP COMPARTMENT



Berny 6982

Backpack. Polyester 600D RPET. Padded. Padded Laptop and Tablet Compartment.

Rucksack. Polyester 600D RPET. Gepolstert. Gepolsterte Laptotasche und Tablet.

Sac à Dos. Polyester 600D RPET. Rembourré. Pochette Rembourrée pour Portable et Tablette.

Rugzak. Polyester 600D RPET. Gewatteerd. Gewatteerd Laptop en Tablet Compartment.

 29 x 46 x 16 cm  20  Print Code: N(8)



02



08



06

Budley 1040



Backpack. Polyester 300D RPET. Padded. Padded Laptop and Tablet Compartment.

Rucksack. Polyester 300D RPET. Gepolstert. Gepolsterte Laptotasche und Tablet.

Sac à Dos. Polyester 300D RPET. Rembourré. Pochette Rembourrée pour Portable et Tablette.

Rugzak. Polyester 300D RPET. Gewatteerd. Gewatteerd Laptop en Tablet Compartment.

 27 x 42 x 14 cm  20  Print Code: G(1), N(8)



TABLET COMPARTMENT



LAPTOP COMPARTMENT



02



18



06



Arcano 4591



08

Backpack. Nylon 600D. Padded Laptop Compartment. Padded Back and Shoulder Straps.
Rucksack. Nylon 600D. Gepolsterte Laptotasche. Gepolsterter Rücken und Schultergurte.
Sac à Dos. Nylon 600D. Pochette Rembourrée pour Portable. Dos et Bretelles Rembourrées.
Rugzak. Nylon 600D. Gewatteerd Laptop Compartment. Gewatteerde Achterzijde en Schouderbanden.

32.5 x 44 x 25 cm 20 / 5 Print Code: G(1), N(8)



08



06



Shamer 5445



02

Backpack. Nylon 600D. Padded Laptop Compartment. Padded Back and Shoulder Straps.
Rucksack. Nylon 600D. Gepolsterte Laptotasche. Gepolsterter Rücken und Schultergurte.
Sac à Dos. Nylon 600D. Pochette Rembourrée pour Portable. Dos et Bretelles Rembourrées.
Rugzak. Nylon 600D. Gewatteerd Laptop Compartment. Gewatteerde Achterzijde en Schouderbanden.

29 x 41 x 18 cm 20 Print Code: G(1), N(8)

ANTI-THEFT
POCKETTROLLEY
STRAPTABLET
COMPARTMENTLAPTOP
COMPARTMENT

Frissa 1470

Anti-Theft Backpack. Polyester 600D. USB Connection. Padded. Padded Laptop and Tablet Compartment.
Anti-Diebstahl Rucksack. Polyester 600D. USB Anschluss. Gepolstert. Gepolsterte Laptotasche und Tablet.
Sac à Dos Antivol. Polyester 600D. Connexion USB. Rembourré. Pochette Rembourrée pour Portable et Tablette.
Anti-Diefstal Rugzak. Polyester 600D. USB Verbinding. Gewatteerd. Gewatteerd Laptop en Tablet Compartment.

29 x 44 x 16 cm 20 Print Code: G(1), N(8)



08



Eris 3668



02

Backpack. Nylon 900D. Padded Laptop Compartment. Padded Back and Shoulder Straps.
Rucksack. Nylon 900D. Gepolsterte Laptotasche. Gepolsterter Rücken und Schultergurte.
Sac à Dos. Nylon 900D. Pochette Rembourrée pour Portable. Dos et Bretelles Rembourrées.
Rugzak. Nylon 900D. Gewatteerd Laptop Compartment. Gewatteerde Achterzijde en Schouderbanden.

30 x 41 x 14 cm 20 Print Code: G(1), N(8)



Prikan 6473

Backpack. Polyester 600D. USB Connection. Padded. Padded Laptop Compartment.
Rucksack. Polyester 600D. USB Anschluss. Gepolstert. Gepolsterte Laptoptasche.
Sac à Dos. Polyester 600D. Connexion USB. Rembourré. Pochette Rembourrée pour Portable.
Rugzak. Polyester 600D. USB Verbinding. Gewatteerd. Gewatteerd Laptop Compartment.

31 x 40 x 13 cm 20 Print Code: N(8)



Vectom 6220

Anti-Theft Backpack. Polyester 300D. USB Connection. Padded Laptop and Tablet Compartment. Padded Back and Shoulder Straps.

Anti-Diebstahl Rucksack. Polyester 300D. USB Anschluss. Gepolsterte Laptoptasche und Tablet. Gepolsterter Rücken und Schultergurte.

Sac à Dos Antivol. Polyester 300D. Connexion USB. Pochette Rembourrée pour Portable et Tablette. Dos et Bretelles Rembourrées.

Anti-Diefstal Rugzak. Polyester 300D. USB Verbinding. Gewatteerd Laptop en Tablet Compartment. Gewatteerde Achterzijde en Schouderbanden.

35 x 47 x 15 cm 20 Print Code: G(1), N(8)



Donovan 5155

Backpack. Polyester 600D. Padded Laptop Compartment. Padded Back and Shoulder Straps.
Rucksack. Polyester 600D. Gepolsterte Laptoptasche. Gepolsterter Rücken und Schultergurte.
Sac à Dos. Polyester 600D. Pochette Rembourrée pour Portable. Dos et Bretelles Rembourrées.
Rugzak. Polyester 600D. Gewatteerd Laptop Compartment. Gewatteerde Achterzijde en Schouderbanden.

32 x 44 x 18 cm 20 Print Code: G(1), N(8)



Nevium 5446

Backpack. Polyester 600D. Padded Laptop Compartment. Padded Back and Shoulder Straps.
Rucksack. Polyester 600D. Gepolsterte Laptoptasche. Gepolsterter Rücken und Schultergurte.
Sac à Dos. Polyester 600D. Pochette Rembourrée pour Portable. Dos et Bretelles Rembourrées.
Rugzak. Polyester 600D. Gewatteerd Laptop Compartment. Gewatteerde Achterzijde en Schouderbanden.

30 x 43 x 14 cm 10 Print Code: G(1), N(8)



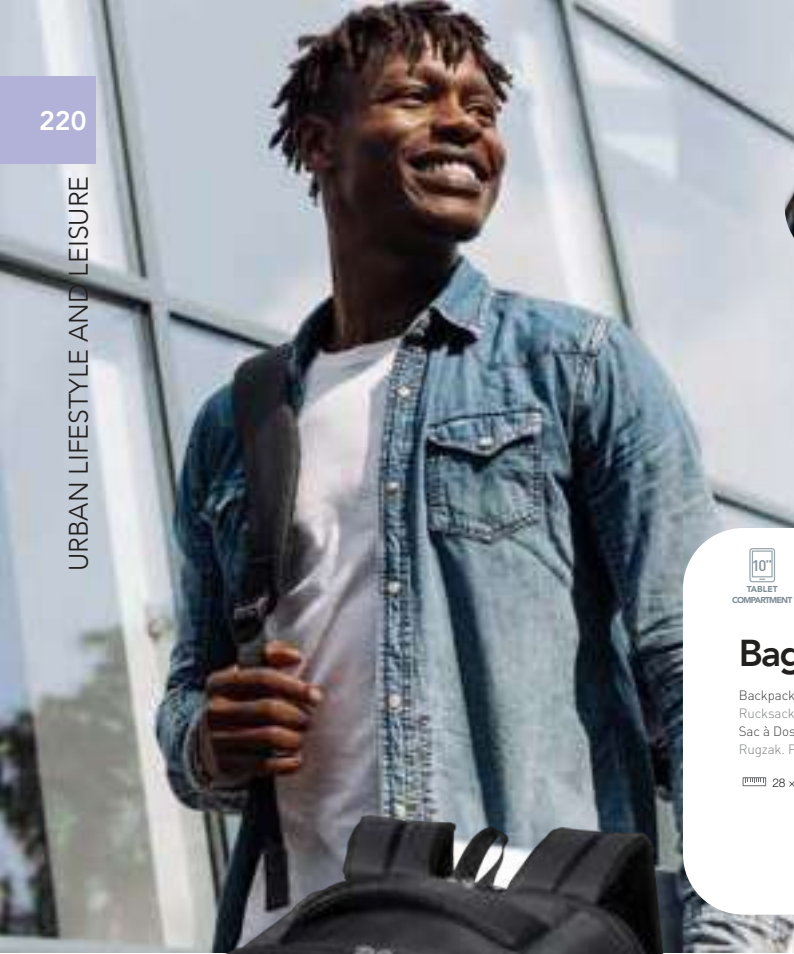

New



Baggel 20880

Backpack. Polyester 600D. Padded Laptop Compartment. Padded Back and Shoulder Straps.
Rucksack. Polyester 600D. Gepolsterte Laptoptasche. Gepolsterter Rücken und Schultergurte.
Sac à Dos. Polyester 600D. Pochette Rembourrée pour Portable. Dos et Bretelles Rembourrées.
Rugzak. Polyester 600D. Gewatteerd Laptop Compartment. Gewatteerde Achterzijde en Schouderbanden.

28 x 41 x 15 cm 10 Print Code: G(1), N(8)



Mauroz 1847

Backpack. Nylon 600D. Padded Laptop and Tablet Compartment. Padded Back and Shoulder Straps.
Rucksack. Nylon 600D. Gepolsterte Laptoptasche und Tablet. Gepolsterter Rücken und Schultergurte.
Sac à Dos. Nylon 600D. Pochette Rembourrée pour Portable et Tablette. Dos et Bretelles Rembourrées.
Rugzak. Nylon 600D. Gewatteerd Laptop en Tablet Compartment. Gewatteerde Achterzijde en Schouderbanden.

35 x 45 x 19 cm 10 Print Code: G(1), N(8)



06



02

Zircan 5307

Backpack. Nylon. USB Connection. Padded Laptop Compartment. Padded Back and Shoulder Straps.
Rucksack. Nylon. USB Anschluss. Gepolsterte Laptoptasche. Gepolsterter Rücken und Schultergurte.
Sac à Dos. Nylon. Connexion USB. Pochette Rembourrée pour Portable. Dos et Bretelles Rembourrées.
Rugzak. Nylon. USB Verbinding. Gewatteerd Laptop Compartment. Gewatteerde Achterzijde en Schouderbanden.

30 x 45 x 20 cm 10 Print Code: G(1), N(8)



New



Tidol 21114

Backpack. Polyester 600D/ PU. Padded Laptop and Tablet Compartment. Padded Back and Shoulder Straps.
Rucksack. Polyester 600D/ PU. Gepolsterte Laptoptasche und Tablet. Gepolsterter Rücken und Schultergurte.
Sac à Dos. Polyester 600D/ Similicuir. Pochette Rembourrée pour Portable et Tablette. Dos et Bretelles Rembourrées.
Ruzgak. Poliestere 600D/ PU. Gewatteerd Laptop en Tablet Compartment. Gewatteerde Achterzijde en Schouderbanden.

30 x 40 x 11 cm 20 Print Code: G(1), N(8)

New



Sarek 21115

Backpack. Polyester 600D/ PU. Padded Laptop and Tablet Compartment. Padded Back and Shoulder Straps.
Rucksack. Polyester 600D/ PU. Gepolsterte Laptoptasche und Tablet. Gepolsterter Rücken und Schultergurte.
Sac à Dos. Polyester 600D/ Similicuir. Pochette Rembourrée pour Portable et Tablette. Dos et Bretelles Rembourrées.
Ruzgak. Poliestere 600D/ PU. Gewatteerd Laptop en Tablet Compartment. Gewatteerde Achterzijde en Schouderbanden.

29 x 42 x 11 cm 20 Print Code: G(1), N(8)

New



Nexera 20887

Backpack. PU. Padded Laptop and Tablet Compartment. Padded Back and Shoulder Straps.
Rucksack. PU. Gepolsterte Laptoptasche und Tablet. Gepolsterter Rücken und Schultergurte.
Sac à Dos. Similicuir. Pochette Rembourrée pour Portable et Tablette. Dos et Bretelles Rembourrées.
Ruzgak. PU. Gewatteerd Laptop en Tablet Compartment. Gewatteerde Achterzijde en Schouderbanden.

31 x 44 x 12 cm 20 Print Code: N(8)

New



Lucenik 20888

Backpack. PU. Padded. Padded Laptop Compartment.
Rucksack. PU. Gepolstert. Gepolsterte Laptoptasche.
Sac à Dos. Similicuir. Rembourré. Pochette Rembourrée pour Portable.
Ruzgak. PU. Gewatteerd. Gewatteerd Laptop Compartment.

32 x 61 x 13 cm 20 Print Code: N(8)



ANTONIO MIRO

New



Kendrit 7362

Backpack. Polyester 600D. Padded. Padded Laptop and Tablet Compartment.
 Rucksack. Polyester 600D. Gepolstert. Gepolsterte Laptotasche und Tablet.
 Sac à Dos. Polyester 600D. Rembourré. Pochette Rembourrée pour Portable et Tablette.
 Ruzgak. Polyester 600D. Gewatteerd. Gewatteerd Laptop en Tablet Compartment.

30 x 44 x 11 cm 10 Print Code: N(8)



Ladian 7392

Backpack. PU. Padded. Padded Laptop and Tablet Compartment.
 Rucksack. PU. Gepolstert. Gepolsterte Laptotasche und Tablet.
 Sac à Dos. Similicuir. Rembourré. Pochette Rembourrée pour Portable et Tablet.
 Ruzgak. PU. Gewatteerd. Gewatteerd Laptop en Tablet Compartment.

29 x 43 x 15 cm 15 Print Code: H(1)



LIMITED
edition
EXPERIENCE

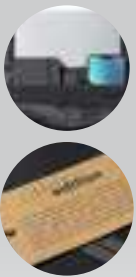

Sulust 1346

Backpack. Polyester 600D/ PVC. Padded Laptop Compartment. Padded Back and Shoulder Straps.
 Rucksack. Polyester 600D/ PVC. Gepolsterte Laptotasche. Gepolsterte Rücken und Schultergurte.
 Sac à Dos. Polyester 600D/ PVC. Pochette Rembourrée pour Portable. Dos et Bretelles Rembourrées.
 Ruzgak. Polyester 600D/ PVC. Gewatteerd Laptop Compartment. Gewatteerde Achterzijde en Schouderbanden.

31 x 45 x 12 cm 10 Print Code: F(1), H(1)





Snorlax 1447

Backpack. Canvas/ PU. Padded Laptop and Tablet Compartment. Padded Back and Shoulder Straps.
Rucksack. Segeltuch/ PU. Gepolsterte Laptopasche und Tablet. Gepolsterter Rücken und Schultergurte.
Sac à Dos. Toile/ Similicuir. Pochette Rembourrée pour Portable et Tablette. Dos et Bretelles Rembourrées.
Rugzak. Canvas/ PU. Gewatteerd Laptop en Tablet Compartment. Gewatteerde Achterzijde en Schouderbanden.

32 x 44 x 14 cm

10

Print Code: G(1), N(8)



Grant 20199

Backpack. Canvas/ PU. Padded Laptop and Tablet Compartment. Padded Back.
Rucksack. Segeltuch/ PU. Gepolsterte Laptopasche und Tablet. Gepolsterter Rücken.
Sac à Dos. Toile/ Similicuir. Pochette Rembourrée pour Portable et Tablette. Dos Rembourré.
Rugzak. Canvas/ PU. Gewatteerd Laptop en Tablet Compartment. Gewatteerde Achterzijde.

31 x 42 x 13 cm

10

Print Code: G(1), N(8)



Zakian 1843

Backpack. Felt RPET/ PU.
Rucksack. Filz RPET/ PU.
Sac à Dos. Feutrine RPET/ Similicuir.
Rugzak. Vilt RPET/ PU.

28.5 x 37.5 x 12 cm

30

Print Code: G(1), N(8)



06



08



Sherpak 1089

Backpack. Polyester 300D RPET. Padded Back and Shoulder Straps.
Rucksack. Polyester 300D RPET. Gepolsterter Rücken und Schultergurte.
Sac à Dos. Polyester 300D RPET. Dos et Bretelles Rembourrées.
Rugzak. Polyester 300D RPET. Gewatteerde Achterzijde en Schouderbanden.

31.5 x 39 x 14.5 cm

30

Print Code: G(1), N(8)





Krepak 6597

Indicator Backpack. Polyester 600D. 4 Leds. 3 Light Modes, Fixed and Flashing. Padded Laptop Compartment. Padded Back and Shoulder Straps. Button Batteries Included.
 Rucksack-Anzeiger. Polyester 600D. 4 Leds. 3 Lichtpositionen, Festes und Blinkendes. Gepolsterte Laptoptasche. Gepolsterter Rücken und Schultergurte. Knopfzellen Inklusive.
 Sac à Dos Indicateur. Polyester 600D. 4 Leds. 3 Modes de Lumière, Fixe et Clignotante. Pochette Rembourrée pour Portable. Dos et Bretelles Rembourrées. Piles Bouton Inclusives.
 Rugzak Richtingaangever. Polyester 600D. 4 Leds. 3 Licht Posities, Vast en Knipperend. Gewatteerd Laptop Compartment. Gewatteerde Achterzijde en Schouderbanden. Knoopcel Batterijen Inclusief.

30 x 43 x 13.5 cm 20 Print Code: G(1), N(8)



Koneit 6128

Charger Backpack. Polyester 1200D. Solar Panel 6,5W. USB Connection. Padded Laptop and Tablet Compartment. Padded Back and Shoulder Straps. Combination Lock.
 Ladegerät Rucksack. Polyester 1200D. Sonnenkollektor 6,5W. USB Anschluss. Gepolsterte Laptoptasche und Tablet. Gepolsterter Rücken und Schultergurte. Sicherheitsverschluss.
 Sac à Dos Chargeur. Polyester 1200D. Panneau Solaire 6,5W. Connexion USB. Pochette Rembourrée pour Portable et Tablette. Dos et Bretelles Rembourrées. Fermeture Sécurité.
 Oplader Rugzak. Polyester 1200D. Zonnepaneel 6,5W. USB Verbinding. Gewatteerd Laptop en Tablet Compartment. Gewatteerde Achterzijde en Schouderbanden. Veiligheidsluiting.

34 x 45 x 16.5 cm 10 Print Code: I(8)



Dontax 6251

Indicator Backpack. Polyester 600D. Flashing Led Lights. Padded Laptop Compartment. Padded Back and Shoulder Straps. USB Connection.
 Rucksack-Anzeiger. Polyester 600D. Blinkendes Led Lichter. Gepolsterte Laptoptasche. Gepolsterter Rücken und Schultergurte. Anschluss USB.
 Sac à Dos Indicateur. Polyester 600D. Lumières Led Clignotantes. Pochette Rembourrée pour Portable. Dos et Bretelles Rembourrées. Connexion USB.
 Rugzak Richtingaangever. Polyester 600D. Knipperend Led Lichten. Gewatteerd Laptop Compartment. Gewatteerde Achterzijde en Schouderbanden. Micro USB Connectie.

31 x 45 x 17 cm 20 Print Code: G(1), N(8)



Halton 5972

Indicator Backpack. Polyester 600D. Flashing Led Lights. Padded Laptop Compartment. Padded Back and Shoulder Straps. USB Connection.
 Rucksack-Anzeiger. Polyester 600D. Blinkendes Led Lichter. Gepolsterte Laptoptasche. Gepolsterter Rücken und Schultergurte. Anschluss USB.
 Sac à Dos Indicateur. Polyester 600D. Lumières Led Clignotantes. Pochette Rembourrée pour Portable. Dos et Bretelles Rembourrées. Connexion USB.
 Rugzak Richtingaangever. Polyester 600D. Knipperend Led Lichten. Gewatteerd Laptop Compartment. Gewatteerde Achterzijde en Schouderbanden. USB Connectie.

28 x 44 x 14 cm 15 Print Code: N(8)



CONTROL



Biltrix 5947

Anti-Theft Backpack. Nylon 1200D. USB Connection. Padded Laptop and Tablet Compartment. Padded Back and Shoulder Straps.

Anti-Diebstahl Rucksack. Nylon 1200D. USB Anschluss. Gepolsterte Laptotasche und Tablet. Gepolsterter Rücken und Schultergurte.

Sac à Dos Antivol. Nylon 1200D. Connexion USB. Pochette Rembourrée pour Portable et Tablette. Dos et Bretelles Rembourrées.

Anti-Diefstal Rugzak. Nylon 1200D. USB Verbinding. Gewatteerd Laptop en Tablet Compartment. Gewatteerde Achterzijde en Schouderbanden.

30 x 44 x 16 cm 10 Print Code: G(1), N(8)



Ranley 5949

Anti-Theft Backpack. Polyester 900D. USB Connection. Padded Laptop and Tablet Compartment. Padded Back and Shoulder Straps. Combination Lock.

Anti-Diebstahl Rucksack. Polyester 900D. USB Anschluss. Gepolsterte Laptotasche und Tablet. Gepolsterter Rücken und Schultergurte. Sicherheitsverschluss.

Sac à Dos Antivol. Polyester 900D. Connexion USB. Pochette Rembourrée pour Portable et Tablette. Dos et Bretelles Rembourrées. Fermeture Sécurité.

Anti-Diefstal Rugzak. Polyester 900D. USB Verbinding. Gewatteerd Laptop en Tablet Compartment. Gewatteerde Achterzijde en Schouderbanden. Veiligheidsluiting.

30 x 49 x 16.5 cm 10 Print Code: G(1), N(8)



Howar 6596

Cool Bag Backpack. Polyester 600D/ PEVA. Padded Shoulder Straps. Kühltasche Rucksack. Polyester 600D/ PEVA. Gepolsterte Schultergurte. Sac à Dos Glacière. Polyester 600D/ PEVA. Bretelles Rembourrées. Koeltas-Rugzak. Polyester 600D/ PEVA. Gewatteerde Schouderbanden.

30 x 62 x 13 cm 20 Print Code: G(1), N(8)



Gaslin 20622

Cool Bag Backpack. Polyester 600D RPET/ PEVA. Padded Back and Shoulder Straps. Kühltasche Rucksack. Polyester 600D RPET/ PEVA. Gepolsterter Rücken und Schultergurte. Sac à Dos Glacière. Polyester 600D RPET/ PEVA. Dos et Bretelles Rembourrées. Koeltas-Rugzak. Polyester 600D RPET/ PEVA. Gewatteerde Achterzijde en Schouderbanden.

31.5 x 44 x 19 cm 10 Print Code: G(1), N(8)





New



Makarzur 21046

Document Bag Backpack. Polyester 600D RPET. Padded Laptop Compartment. Padded Back and Shoulder Straps.
 Dokumententasche Rucksack. Polyester 600D RPET. Gepolsterte Laptoptasche. Gepolsterter Rücken und Schultergurte.
 Sac à Dos Porte-Documents. Polyester 600D RPET. Pochette Rembourrée pour Portable. Dos et Bretelles Rembourrées.
 Aktentas Rugzak. Polyester 600D RPET. Gewatteerd Laptop Compartment. Gewatteerde Achterzijde en Schouderbanden.

28 x 40.5 x 13 cm 10 Print Code: I(8)



15" LAPTOP COMPARTMENT 2in1 MULTIFUNCTION TROLLEY STRAP

Hurkon 6509

Document Bag Backpack. Polyester 300D/ PU. Padded. Padded Laptop Compartment.
 Dokumententasche Rucksack. Polyester 300D/ PU. Gepolstert. Gepolsterte Laptoptasche.
 Sac à Dos Porte-Documents. Polyester 300D/ Similicuir. Rembourré. Pochette Rembourrée pour Portable.
 Aktentas Rugzak. Polyester 300D/ PU. Gewatteerd. Gewatteerd Laptop Compartment.

32 x 41 x 12.5 cm 10 Print Code: I(8)



Sleiter 1471

12" TABLET COMPARTMENT 17" LAPTOP COMPARTMENT 2in1 MULTIFUNCTION

Document Bag Backpack. Polyester 300D/ PU. Padded. Padded Laptop and Tablet Compartment.
 Dokumententasche Rucksack. Polyester 300D/ PU. Gepolstert. Gepolsterte Laptoptasche und Tablet.
 Sac à Dos Porte-Documents. Polyester 300D/ Similicuir. Rembourré. Pochette Rembourrée pour Portable et Tablette.
 Aktentas Rugzak. Poliestere 300D/ PU. Gewatteerd. Gewatteerd Laptop en Tablet Compartment.

29 x 45 x 16 cm 10 Print Code: I(8)



17" LAPTOP COMPARTMENT 2in1 MULTIFUNCTION ANTI THEFT POCKET TROLLEY STRAP

Sulkan 6620

Document Bag Backpack. Polyester 600D. USB Connection. Padded. Padded Laptop Compartment.
 Dokumententasche Rucksack. Polyester 600D. USB Anschluss. Gepolstert. Gepolsterte Laptoptasche.
 Sac à Dos Porte-Documents. Polyester 600D. Connexion USB. Rembourré. Pochette Rembourrée pour Portable.
 Aktentas Rugzak. Polyester 600D. USB Verbinding. Gewatteerd. Gewatteerd Laptop Compartment.

32 x 46 x 20 cm 10 Print Code: I(8)



Halnok 5590

Backpack. Polyester 600D. USB Connection. Padded Laptop and Tablet Compartment. Padded Back and Shoulder Straps.
Rucksack. Polyester 600D. USB Anschluss. Gepolsterte Laptoptasche und Tablet. Gepolsterter Rücken und Schultergurte.
Sac à Dos. Polyester 600D. Connexion USB. Pochette Rembourrée pour Portable et Tablette. Dos et Bretelles Rembourrées.
Rugzak. Polyester 600D. USB Verbinding. Gewatteerd Laptop en Tablet Compartment. Gewatteerde Achterzijde en Schouderbanden.

32 x 42 x 15 cm 30 Print Code: G(1), N(8)

New



Ospark 21128

Backpack. Nylon 600D. Padded Laptop Compartment. Padded Back and Shoulder Straps.
Rucksack. Nylon 600D. Gepolsterte Laptoptasche. Gepolsterter Rücken und Schultergurte.
Sac à Dos. Nylon 600D. Pochette Rembourrée pour Portable. Dos et Bretelles Rembourrées.
Rugzak. Nylon 600D. Gewatteerd Laptop Compartment. Gewatteerde Achterzijde en Schouderbanden.

32 x 45 x 21 cm 20 Print Code: N(8)



Verbel 5232

Backpack. Polyester 600D. Padded Laptop Compartment. Padded Back and Shoulder Straps.
Rucksack. Polyester 600D. Gepolsterte Laptoptasche. Gepolsterter Rücken und Schultergurte.
Sac à Dos. Polyester 600D. Pochette Rembourrée pour Portable. Dos et Bretelles Rembourrées.
Rugzak. Polyester 600D. Gewatteerd Laptop Compartment. Gewatteerde Achterzijde en Schouderbanden.

32 x 42 x 15 cm 30 Print Code: G(1), N(8)



Komplete 6345

Anti-Theft Backpack. Polyester 300D. RFID Pocket Protection. USB Connection. Padded Laptop and Tablet Compartment. Padded Back and Shoulder Straps.
Anti-Diebstahl Rucksack. Polyester 300D. Tasche mit RFID Schutz. USB Anschluss. Gepolsterte Laptoptasche und Tablet. Gepolsterter Rücken und Schultergurte.
Sac à Dos Antivol. Polyester 300D. Poche avec Protecteur RFID. Connexion USB. Pochette Rembourrée pour Portable et Tablette. Dos et Bretelles Rembourrées.
Anti-Diefstal Rugzak. Polyester 300D. Zak met RFID Bescherming. USB Verbinding. Gewatteerd Laptop en Tablet Compartment. Gewatteerde Achterzijde en Schouderbanden.

28 x 40 x 12 cm 30 Print Code: G(1), N(8), O, P



19

RFID PROTECTION

Rigal 6215

Backpack. Polyester 300D. RFID Pocket Protection. USB Connection. Padded Back and Shoulder Straps.
Rucksack. Polyester 300D. Tasche mit RFID Schutz. USB Anschluss. Gepolsterter Rücken und Schultergurte.
Sac à Dos. Polyester 300D. Poche avec Protecteur RFID. Connexion USB. Dos et Bretelles Rembourrées.
Rugzak. Polyester 300D. Zak met RFID Bescherming. USB Verbinding. Gewatteerde Achterzijde en Schouderbanden.

30 x 43 x 14 cm 40 Print Code: G(1), N(8)



2 IN 1



TROLLEY LAPTOP BACKPACK



ANTONIO MIRO



Dancan 20895

Trolley Backpack. Polyester 300D. Padded Laptop Compartment. Padded Back and Shoulder Straps.

Trolley Rucksack. Polyester 300D. Gepolsterte Laptoptasche. Gepolsterter Rücken und Schultergurte.

Sac à Dos Trolley. Polyester 300D. Pochette Rembourrée pour Portable. Dos et Bretelles Rembourrées.

Trolley Rugzak. Polyester 300D. Gewatteerd Laptop. Gewatteerde Achterzijde en Schouderbanden.

33.5 x 51 x 21 cm 4 Print Code: J(8), L2

LAPTOP
COMPARTMENT

06

Haltrix 6047

Trolley Backpack. Polyester 300D. USB Connection. Padded Laptop Compartment. Padded Shoulder Straps.

Trolley Rucksack. Polyester 300D. USB Anschluss. Gepolsterte Laptoptasche. Gepolsterte Schultergurte.

Sac à Dos Trolley. Polyester 300D. Connexion USB. Pochette Rembourrée pour Portable. Bretelles Rembourrées.

Trolley Rugzak. Polyester 300D. USB Verbinding. Gewatteerd Laptop. Gewatteerde Schouderbanden.

33 x 47 x 22.5 cm 8 Print Code: J(8), L2



02

Gibut 7373

Trolley Backpack. Polyester 300D. Padded Laptop Compartment. Padded Shoulder Straps.

Trolley Rucksack. Polyester 300D. Gepolsterte Laptoptasche. Gepolsterte Schultergurte.

Sac à Dos Trolley. Polyester 300D. Pochette Rembourrée pour Portable. Bretelles Rembourrées.

Trolley Rugzak. Polyester 300D. Gewatteerd Laptop. Gewatteerde Schouderbanden.

33 x 47 x 22.5 cm 8 Print Code: J(1), L2

TABLET
COMPARTMENTLAPTOP
COMPARTMENTTABLET
COMPARTMENTLAPTOP
COMPARTMENT



New

LAPTOP
COMPARTMENT

Tanen 20885

Document Bag Backpack. PU. Padded. Padded Laptop Compartment.

Dokumententasche Rucksack. PU. Gepolstert. Gepolsterte Laptoptasche.

Sac à Dos Porte-Documents. Similicuir. Rembourré. Pochette Rembourrée pour Portable.

Aktentas Rugzak. PU. Gewatteerd. Gewatteerd Laptop Compartment.

33 x 48 x 16 cm 10
 Print Code: J(1)



New

TROLLEY
STRAP17"
LAPTOP
COMPARTMENT

02

Myriax 20354

Backpack. Polyester 300D RPET. USB Connection. Padded. Padded Laptop Compartment. Shoe Compartment.

Rucksack. Polyester 300D RPET. USB Anschluss. Gepolstert. Gepolsterte Laptoptasche. Schuh Staufach.

Sac à Dos. Polyester 300D RPET. Connexion USB. Rembourré. Pochette Rembourrée pour Portable. Compartiment Porte-Chaussures.

Rugzak. Polyester 300D RPET. USB Verbinding. Gewatteerd. Gewatteerd Laptop Compartment. Schoen Compartment.

33 x 51 x 20 cm 10 Print Code: J(8)



08





Denehy 20886

Backpack Bag. PU. Padded Back and Shoulder Straps. Shoe Compartment.
Rucksack Tasche. PU. Gepolsterter Rücken und Schultergurte. Schuh Staufach.
Sac à Dos. Similicuir. Dos et Bretelles Rembourrées. Compartiment Porte-Chaussures.
Ruzgak. PU. Gewatteerde Achterzijde en Schouderbanden. Schoen Compartment.

52 x 26 x 25 cm 10 Print Code: H(1)



ANTONIO MIRO



Tronen 7374

Bag. Polyester 300D.
Tasche. Polyester 300D.
Sac. Polyester 300D.
Tas. Polyester 300D.

50 x 30 x 25 cm 30 Print Code: N(8)

LIMITED
edition
EXPERIENCE



Dufress 1347



Bag. Polyester 600D/ PVC. Padded.
Tasche. Polyester 600D/ PVC. Gepolstert.
Sac. Polyester 600D/ PVC. Rembourré.
Tas. Polyester 600D/ PVC. Gewatteerd.

46 x 29 x 23.5 cm 10 Print Code: F(1), H(1)



Canvas



New



Sharyl 20200

Bag. Canvas/ PU.
Tasche. Segeltuch/ PU.
Sac. Toile/ Similicuir.
Tas. Canvas/ PU.

70 x 36 x 24 cm 10 Print Code: H(1), N(8)



Denver 1629

Bag. Felt RPET/ PU.
Tasche. Filz RPET/ PU.
Sac. Feutrine RPET/ Similicuir.
Tas. Vilt RPET/ PU.

53 x 30 x 26 cm 20 Print Code: H(1), N(8)



06

Stariux 1446

Bag. Canvas/ PU.
Tasche. Segeltuch/ PU.
Sac. Toile/ Similicuir.
Tas. Canvas/ PU.

75 x 48 x 25 cm 10 Print Code: H(1), N(8)

13



02

Melbor 6815

Bag, Polyester 600D.
Tasche, Polyester 600D.
Sac, Polyester 600D.
Tas, Polyester 600D.

65 x 34 x 33 cm 10
 Print Code: G(1), N(8)



03



06

19

16



03

Drako 3632

Bag, Polyester 600D.
Tasche, Polyester 600D.
Sac, Polyester 600D.
Tas, Polyester 600D.

52 x 27 x 25 cm 30
 Print Code: G(1), N(8)



04

07



02

19



06



02

Novo 9146

Bag, Polyester 600D.
Tasche, Polyester 600D.
Sac, Polyester 600D.
Tas, Polyester 600D.

42 x 24 x 20 cm 50
 Print Code: G(1), N(8)



11

02

03



19

04

07

Divux 6494

Backpack Bag, Nylon 420D. Padded Back and Shoulder Straps. Shoe Compartment.
Rucksack Tasche, Nylon 420D. Gepolsterter Rücken und Schultergurte. Schuh
Staufach.

Sac à Dos, Nylon 420D. Dos et Bretelles Rembourrées. Compartiment Porte-
Chaussures.

Rugzak, Nylon 420D. Gewatteerde Achterzijde en Schouderbanden. Schoen
Compartiment.

47 x 25 x 24 cm 20 Print Code: G(1), N(8)



03

19

RPET



Holtrum 6841

Bag, Polyester 600D RPET.
Tasche, Polyester 600D RPET.
Sac, Polyester 600D RPET.
Tas, Polyester 600D RPET.

48.5 x 28 x 27.5 cm 30 Print Code: G(1), N(8)



Monik 20900 08

Bag, Polyester 600D RPET.
Tasche, Polyester 600D RPET.
Sac, Polyester 600D RPET.
Tas, Polyester 600D RPET.

53 x 33 x 22 cm 20 Print Code: G(1), N(8)



06

02



Donatox 6043

Bag, Polyester 600D. USB Connection. Shoe Compartment.
Tasche, Polyester 600D. USB Anschluss. Schuh Staufach.
Sac, Polyester 600D. Connexion USB. Compartiment Porte-Chaussures.
Tas, Polyester 600D. USB Verbindung. Schoen Compartment.

50 x 30 x 28.5 cm 25 Print Code: G(1), N(8), P



Lutux 6493

Bag, Polyester 600D.
Tasche, Polyester 600D.
Sac, Polyester 600D.
Tas, Polyester 600D.

45 x 22 x 21 cm 30 Print Code: G(1), N(8)



New

03

Storil 20453

Backpack. Polyester 600D RPET. Padded Back and Shoulder Straps. Shoe Compartment.

Rucksack. Polyester 600D RPET. Gepolsterter Rücken und Schultergurte. Schuh Staufach.

Sac à Dos. Polyester 600D RPET. Dos et Bretelles Rembourrées. Compartiment Porte-Chaussures.

Rugzak. Polyester 600D RPET. Gewatteerde Achterzijde en Schouderbanden. Schoen Compartment.

28 x 42 x 32 cm 15

Print Code: G(1), N(8)



04

19



03

02

Dorian 4466

Backpack. Polyester 600D. Padded Back and Shoulder Straps. Shoe Compartment.

Rucksack. Polyester 600D. Gepolsterter Rücken und Schultergurte. Schuh Staufach.

Sac à Dos. Polyester 600D. Dos et Bretelles Rembourrées. Compartiment Porte-Chaussures.

Rugzak. Polyester 600D. Gewatteerde Achterzijde en Schouderbanden. Schoen Compartment.

30 x 46 x 15 cm 40

Print Code: G(1), N(8)



04

05

06

19



02

19



03

Giant 3003

Duffel Bag. Polyester 600D. 2 in 1 Strap with Zipper.

Seesack. Polyester 600D. 2 in 1 Gürtel mit Reißverschluss.

Balluchon. Polyester 600D. Ruban 2 en 1 avec Fermeture Eclair.

Plunjezak. Polyester 600D. 2 in 1 Band met Rits.

Ø 30 x 54 cm

50

Print Code: G(1), N(8), O, P



New

Lafin 20429

Ball Bag. Polyester 600D RPET.

Balltasche. Polyester 600D RPET.

Sac de Ballon. Polyester 600D RPET.

Balzak. Polyester 600D RPET.

25 x 24 x 30 cm 50

Print Code: G(1), N(8)



03

Wistol 20454

Bag. Polyester 600D RPET. Shoe Compartment.

Tasche. Polyester 600D RPET. Schuh Staufach.

Sac. Polyester 600D RPET. Compartiment Porte-Chaussures.

Tas. Polyester 600D RPET. Schoen Compartment.

48 x 46 x 25 cm 10

Print Code: G(1), N(8)



02

19

04



02

Curcox 4736

Bag. Polyester 600D.

Tasche. Polyester 600D.

Sac. Polyester 600D.

Tas. Polyester 600D.

40 x 29 x 13 cm

50

Print Code: G(1), N(8)



11

06

03

19



RECYCLED
COTTON

03



03

Bandam 1840

Duffel Bag. 100% Recycled Cotton.
Seesack. 100% Recycling Baumwolle.
Balluchon. 100% Coton Recyclé.
Plunjezak. 100% Gerecycled Katoen.

📏 Ø 25 x 45 cm 📦 100 / 10
🔗 Print Code: G(6), N(8), O, P



13

19

02

Golduck 1445

Bag. 100% Recycled Cotton.
Tasche. 100% Recycling Baumwolle.
Sac. 100% Coton Recyclé.
Tas. 100% Gerecycled Katoen.

📏 49 x 26 x 24 cm 📦 20 🔗 Print Code: G(6), N(8), O, P



13

19

02

RECYCLED
COTTON



06



03



02

08

04

Charmix 1042

Bag. Polyester 290T RPET.
Tasche. Polyester 290T RPET.
Sac. Polyester 290T RPET.
Tas. Polyester 290T RPET.

📏 Ø 23 x 48 cm 📦 100 / 25 🔗 Print Code: G(1)



16

19

02

Simaro 5724

Bag. 100% Cotton.
Tasche. 100% Baumwolle.
Sac. 100% Coton.
Tas. 100% Katoen.

📏 Ø 25 x 50 cm 📦 100 / 5 🔗 Print Code: G(6), N(8), O, P



100% COTTON



19



02



03



Virtux 7295

Backpack. Polyester 420D. Padded Back and Shoulder Straps.
Rucksack. Polyester 420D. Gepolsterter Rücken und Schultergurte.
Sac à Dos. Polyester 420D. Dos et Bretelles Rembourrées.
Rugzak. Polyester 420D. Gewatteerde Achterzijde en Schouderbanden.

swisent
ORIZONS
adventure

35 x 53 x 28 cm 20 Print Code: J(8)

ADVENTURE Backpack



03



19



16

Densul 6168



Backpack. Polyester 210D/ Ripstop. Padded Back and Shoulder Straps.
Rucksack. Polyester 210D/ Ripstop. Gepolsterter Rücken und Schultergurte.
Sac à Dos. Polyester 210D/ Ripstop. Dos et Bretelles Rembourrées.
Rugzak. Polyester 210D/ Ripstop. Gewatteerde Achterzijde en Schouderbanden.

32 x 47 x 28 cm 20 Print Code: H(1), N(8)

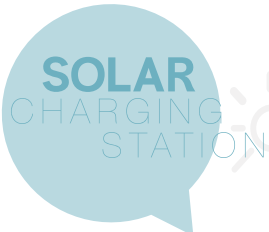

Rasmux 6329

Charger Backpack. Ripstop. Solar Panel 6,5W. USB Connection. Padded Laptop Compartment. Padded Back and Shoulder Straps.
Ladegerät Rucksack. Ripstop. Sonnenkollektor 6,5W. USB Anschluss. Gepolsterter Laptoptasche. Gepolsterter Rücken und Schultergurte.

Sac à Dos Chargeur. Ripstop. Panneau Solaire 6,5W. Connexion USB. Pochette Rembourrée pour Portable. Dos et Bretelles Rembourrées.
Oplader Rugzak. Ripstop. Zonnepaneel 6,5W. USB Verbinding. Gewatteerd Laptop Compartment. Gewatteerde Achterzijde en Schouderbanden.

33 x 52 x 23 cm 10 Print Code: J(8)



04



19



03

New



Sagan 20459

Cool Bag Chair. Polyester 600D RPET/ PEVA.
Stuhl Kühltasche. Polyester 600D RPET/ PEVA.
Chaise Glacière. Polyester 600D RPET/ PEVA.
Stoel-koeltas. Polyester 600D RPET/ PEVA.

31 x 42 x 35 cm 6 Print Code: N(8)



ADVENTURE Backpack

237

URBAN LIFESTYLE AND LEISURE



New

New

New

Demuth 20892

Waistbag, Polyester 800D.
Gürteltasche, Polyester 800D.
Banane, Polyester 800D.
Heuptas, Polyester 800D.

39 x 15 x 9,5 cm 30 Print Code: F(1), N(8)

Gertler 20893

Shoulder Bag, Polyester 800D.
Umhängetasche, Polyester 800D.
Bandoulière, Polyester 800D.
Schoudertas, Polyester 800D.

11 x 16 x 6,5 cm 50 Print Code: F(1), N(8)

Salced 20894

Backpack, Polyester 800D, Padded Back and Shoulder Straps.
Rucksack, Polyester 800D, Gepolsterter Rücken und Schultergurte.
Sac à Dos, Polyester 800D, Dos et Bretelles Rembourrées.
Rugzak, Polyester 800D, Gewatteerde Achterzijde en Schouderbanden.

31 x 44 x 20 cm 10 Print Code: G(1), N(8)

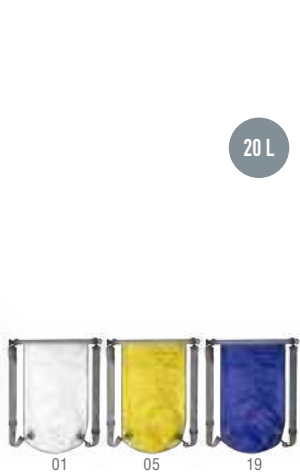

20 L

Tayrux 6513

Backpack, Ripstop, 20 L, Waterproof.
Rucksack, Ripstop, 20 L, Wasserabweisende.
Sac à Dos, Ripstop, 20 L, Imperméable.
Rugzak, Ripstop, 20 L, Waterdicht.

23 x 63 cm 20 Print Code: H(1)



03



New

25 L

Ardentix 20464

Backpack, Polyester 300D RPET, 25 L, Waterproof, Touch Screen.
Rucksack, Polyester 300D RPET, 25 L, Wasserabweisende, Touch Screen.
Sac à Dos, Polyester 300D RPET, 25 L, Imperméable, Ecran Tactile.
Rugzak, Polyester 300D RPET, 25 L, Waterdicht, Touch Screen.

37 x 55 x 13 cm 30 / 10 Print Code: H(1), N(8)



04

REFLECTIVE
FILAMENTS
 NIGHT   DAY

Quasar 6958

Anti-Theft Backpack. Polyester 600D. Reflective. Padded Laptop and Tablet Compartment. Padded Back and Shoulder Straps.

Anti-Diebstahl Rucksack. Polyester 600D. Reflektierend. Gepolsterte Laptoptasche und Tablet. Gepolsterter Rücken und Schultergurte.

Sac à Dos Antivol. Polyester 600D. Réfléchissant. Pochette Rembourrée pour Portable et Tablette. Dos et Bretelles Rembourrées.

Anti-Diefstal Rugzak. Polyester 600D. Refleterend. Gewatteerd Laptop en Tablet Compartment. Gewatteerde Achterzijde en Schouderbanden.

 34 x 47 x 15.5 cm  20  Print Code: N(8)



Stabby 6981

Drawstring Bag. Polyester 600D RPET. Reflective.

Rucksack. Polyester 600D RPET. Reflektierender.

Sac à Dos. Polyester 600D RPET. Réfléchissant.

Rugzak. Polyester 600D RPET. Refleterend.

 34 x 44 cm  100 / 10  Print Code: F(1), N(8)

REFLECTIVE
FABRIC

Bayolet 1137



Drawstring Bag. Polyester 210T. Reflective.

Rucksack. Polyester 210T. Reflektierender.

Sac à Dos. Polyester 210T. Réfléchissant.

Rugzak. Polyester 210T. Refleterend.

 34 x 42 cm  200 / 10  Print Code: F(1), N(8)

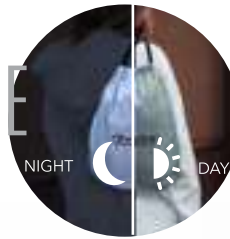
 NIGHT   DAY

Flaser 1136



Waistbag. Polyester 210T. Reflective.

Gürteltasche. Polyester 210T. Reflektierender.

Banane. Polyester 210T. Réfléchissant.

Heuptas. Polyester 210T. Refleterend.

 35 x 12 x 5 cm  100  Print Code: F(1), N(8)



Bilbon 1138



Armband. Polyester 210T. Reflective.

Armband. Polyester 210T. Reflektierender.

Bracelet. Polyester 210T. Réfléchissant.

Armband. Polyester 210T. Refleterend.

 8 x 17.5 x 4 cm  200 / 20  Print Code: E(1), N(8)





Lendross 4734

Backpack. Polyester 600D. Padded Back and Shoulder Straps.
Rucksack. Polyester 600D. Gepolsterter Rücken und Schultergurte.
Sac à Dos. Polyester 600D. Dos et Bretelles Rembourrées.
Rugzak. Polyester 600D. Gewatteerde Achterzijde en Schouderbanden.

29 x 43 x 15 cm 40 Print Code: G(1), N(8), O



Manet 20891

Backpack. Polyester 600D RPET. Padded Back and Shoulder Straps.
Rucksack. Polyester 600D RPET. Gepolsterter Rücken und Schultergurte.
Sac à Dos. Polyester 600D RPET. Dos et Bretelles Rembourrées.
Rugzak. Polyester 600D RPET. Gewatteerde Achterzijde en Schouderbanden.

30 x 45 x 14 cm 40 Print Code: G(1), N(8), O

RPET



Yondix 4735

Backpack. Polyester 600D. Padded Back and Shoulder Straps.
Rucksack. Polyester 600D. Gepolsterter Rücken und Schultergurte.
Sac à Dos. Polyester 600D. Dos et Bretelles Rembourrées.
Rugzak. Polyester 600D. Gewatteerde Achterzijde en Schouderbanden.

32.5 x 43 x 23.5 cm 30 Print Code: G(1), N(8), O

BIG SIZE



Ventix 6814

Backpack. Polyester 600D. Padded Back and Shoulder Straps.
Rucksack. Polyester 600D. Gepolsterter Rücken und Schultergurte.
Sac à Dos. Polyester 600D. Dos et Bretelles Rembourrées.
Rugzak. Polyester 600D. Gewatteerde Achterzijde en Schouderbanden.

31 x 41 x 16 cm 40 Print Code: G(1), N(8), O, P

BIG SIZE



Discovery 9012

Backpack. Polyester 600D. Padded Back and Shoulder Straps.
Rucksack. Polyester 600D. Gepolsterter Rücken und Schultergurte.
Sac à Dos. Polyester 600D. Dos et Bretelles Rembourrées.
Rugzak. Polyester 600D. Gewatteerde Achterzijde en Schouderbanden.

28 x 38 x 12 cm 50 Print Code: G(1), N(8), O, P



Chens 5589

Backpack. Polyester 600D. Padded Back and Shoulder Straps.
Rucksack. Polyester 600D. Gepolsterter Rücken und Schultergurte.
Sac à Dos. Polyester 600D. Dos et Bretelles Rembourrées.
Rugzak. Polyester 600D. Gewatteerde Achterzijde en Schouderbanden.

28 x 38 x 12 cm 40 Print Code: G(1), N(8), O, P



Humus 4057

Backpack. Polyester 600D. Padded Shoulder Straps.
Rucksack. Polyester 600D. Gepolsterter Schultergurte.
Sac à Dos. Polyester 600D. Bretelles Rembourrées.
Rugzak. Polyester 600D. Gewatteerde Schouderbanden.

30 x 40 x 18 cm 40 Print Code: G(1), N(8), O



Soken 5400

Backpack. Polyester 600D.
Rucksack. Polyester 600D.
Sac à Dos. Polyester 600D.
Rugzak. Polyester 600D.

29 x 39 x 19 cm 30 Print Code: G(1), N(8), O, P

RPET



New



02 08 19

Sergli 20890

Backpack. Polyester 300D RPET. Padded Back and Shoulder Straps.
Rucksack. Polyester 300D RPET. Gepolsterter Rücken und Schultergurte.
Sac à Dos. Polyester 300D RPET. Dos et Bretelles Rembourrées.
Rugzak. Polyester 300D RPET. Gewatteerde Achterzijde en Schouderbanden.

30 x 40 x 18 cm 30 Print Code: G(1), N(8)



New



01 02 04 19

Vaega 20889

Backpack. Polyester 600D RPET. Padded Back and Shoulder Straps.
Rucksack. Polyester 600D RPET. Gepolsterter Rücken und Schultergurte.
Sac à Dos. Polyester 600D RPET. Dos et Bretelles Rembourrées.
Rugzak. Polyester 600D RPET. Gewatteerde Achterzijde en Schouderbanden.

27 x 45 x 14 cm 40 Print Code: G(1), N(8)



New



15" LAPTOP COMPARTMENT



08 02

Turmon 21094

Backpack. Polyester 600D RPET. Padded Laptop Compartment. Padded Back and Shoulder Straps.
Rucksack. Polyester 600D RPET. Gepolsterte Laptoptasche. Gepolsterter Rücken und Schultergurte.
Sac à Dos. Polyester 600D RPET. Pochette Rembourrée pour Portable. Dos et Bretelles Rembourrées.
Rugzak. Polyester 600D RPET. Gewatteerd Laptop Compartment. Gewatteerde Achterzijde en Schouderbanden.

29 x 42 x 17 cm 30 Print Code: G(1), N(8), O



13

02 08



SUBLIMATION

Bronul 1846

Backpack. Polyester 600D RPET. Padded Back.
Rucksack. Polyester 600D RPET. Gepolsterter Rücken.
Sac à Dos. Polyester 600D RPET. Dos Rembourré.
Rugzak. Polyester 600D RPET. Gewatteerde Achterzijde.

24.5 x 38 x 13.5 cm 30 Print Code: G(1), N(8), R



06



02 16

19 06

Fabax 6850

Backpack. Polyester 600D RPET. Padded Back and Shoulder Straps. Reflective.
Rucksack. Polyester 600D RPET. Gepolsterter Rücken und Schultergurte. Reflektierend.
Sac à Dos. Polyester 600D RPET. Dos et Bretelles Rembourrées. Réfléchissant.
Rugzak. Polyester 600D RPET. Gewatteerde Achterzijde en Schouderbanden. Reflecterend.

28 x 38 x 12 cm 50 Print Code: G(1), N(8)



03



03

Galpox 6343

Backpack. Polyester 600D. Padded Back and Shoulder Straps.
Rucksack. Polyester 600D. Gepolsterter Rücken und Schultergurte.
Sac à Dos. Polyester 600D. Dos et Bretelles Rembourrées.
Rugzak. Polyester 600D. Gewatteerde Achterzijde en Schouderbanden.

23 x 36 x 13.5 cm 50 Print Code: G(1), N(8), P, R



19

Decath 5228

Backpack. Polyester 600D. Padded Back and Shoulder Straps.
Rucksack. Polyester 600D. Gepolsterter Rücken und Schultergurte.
Sac à Dos. Polyester 600D. Dos et Bretelles Rembourrées.
Rugzak. Polyester 600D. Gewatteerde Achterzijde en Schouderbanden.

23 x 40 x 12 cm 50 Print Code: G(1), N(8), O, R



FOLDABLE

19



FOLDABLE

04



FOLDABLE

03



Signal 5567

Foldable Backpack. Polyester 210D.
Faltbar Rucksack. Polyester 210D.
Sac à Dos Pliable. Polyester 210D.
Opvouwbare Rugzak. Polyester 210D.

22 x 40 x 16 cm 200 / 50 Print Code: G(1), N(8), R

Mathis 5381

Foldable Backpack. Polyester 210D.
Faltbarer Rucksack. Polyester 210D.
Sac à Dos Pliable. Polyester 210D.
Opvouwbare Rugzak. Polyester 210D.

30 x 42 x 12 cm 200 / 50 Print Code: G(1), H(1)



Mendy 6344

Foldable Backpack. Ripstop.
Faltbarer Rucksack. Ripstop.
Sac à Dos Pliable. Ripstop.
Opvouwbare Rugzak. Ripstop.

32 x 43 x 12 cm 100 / 20 Print Code: G(1), H(1)





RPET



Hera 4049

Drawstring Bag, Non-Woven.
Rucksack, Non-Woven.
Sac à Dos, T.N.T.
Rugzak, Non-Woven.

36 x 42 cm 300 / 10 Print Code: F(1)

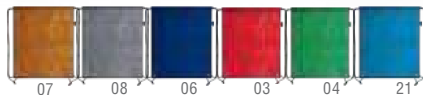

Lambur 6430

Drawstring Bag, Polyester RPET.
Rucksack, Polyester RPET.
Sac à Dos, Polyester RPET.
Rugzak, Polyester RPET.

34 x 42 cm 300 / 50
Print Code: F(1), N(8), R



NEW COLOR



Spook 3164

Drawstring Bag, Polyester 210T.
Rucksack, Polyester 210T.
Sac à Dos, Polyester 210T.
Rugzak, Polyester 210T.

34 x 42 cm 300 / 50
Print Code: F(1), N(8), R



New



New



New

RPET



Selasi 20903

Race Number Drawstring Bag, Polyester 210D.
Startnummernrucksack, Polyester 210D.
Sac à Dos avec Porte Numéro, Polyester 210D.
Racenummerhouder Rugzak, Polyester 210D.

40 x 45 cm 200 / 50 Print Code: F(1), N(8), R



Arlequix 21133

Drawstring Bag, Polyester.
Rucksack, Polyester.
Sac à Dos, Polyester.
Rugzak, Polyester.

33 x 37 cm 250 / 10 Print Code: N(8), R

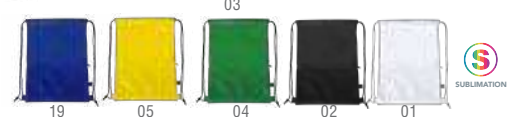

Uznam 20906

Drawstring Bag, Polyester 210D RPET.
Rucksack, Polyester 210D RPET.
Sac à Dos, Polyester 210D RPET.
Rugzak, Polyester 210D RPET.

31 x 43 cm 200 / 10 Print Code: F(1), N(8), R



IDEAL TRANSFER PRINTING



03



New

04



Hildan 20904

Drawstring Bag. Polyester 210T RPET.
Rucksack. Polyester 210T RPET.
Sac à Dos. Polyester 210T RPET.
Rugzak. Polyester 210T RPET.

35 x 46 cm 200 / 50
Print Code: F(1), N(8), R



Sionap 20905

Drawstring Bag. Polyester 210T RPET.
Rucksack. Polyester 210T RPET.
Sac à Dos. Polyester 210T RPET.
Rugzak. Polyester 210T RPET.

36 x 46 cm 200 / 50 Print Code: F(1), N(8), R



04

New



04



02



Falyan 20773

Drawstring Bag. Polyester RPET.
Rucksack Tasche. Polyester RPET.
Sac à Dos. Polyester RPET.
Rugzak Tas. Polyester RPET.

34 x 42 cm 300 / 50 Print Code: F(1), N(8), R

Blades 4780

Drawstring Bag. Polyester 210D.
Rucksack. Polyester 210D.
Sac à Dos. Polyester 210D.
Rugzak. Polyester 210D.

34.5 x 45 cm 200 / 10
Print Code: F(1), N(8), R



Brocky 1041

Backpack. Polyester 210D RPET.
Rucksack. Polyester 210D RPET.
Sac à Dos. Polyester 210D RPET.
Rugzak. Polyester 210D RPET.

30 x 42 x 12 cm 200 / 50
Print Code: G(1), H(1)

FOLDABLE



RPET

**Bass 9727**100 g/m²

Drawstring Bag. 100% Cotton 100 g/ m².
 Rucksack. 100% Baumwolle 100 g/ m².
 Sac à Dos. 100% Coton 100 g/ m².
 Ruzzak. 100% Katoen 100 g/ m².

37 × 41 cm 100 / 10
 Print Code: F(6), N(8), M, O, P



03



19

04

02

Tianax 6119100 g/m²

Drawstring Bag. 100% Cotton 100 g/ m².
 Rucksack. 100% Baumwolle 100 g/ m².
 Sac à Dos. 100% Coton 100 g/ m².
 Ruzzak. 100% Katoen 100 g/ m².

37 × 41 cm 250 / 50
 Print Code: F(6), N(8), O, P

**Curtis 3323**100 g/m²

Drawstring Bag. 100% Cotton 100 g/ m².
 Rucksack. 100% Baumwolle 100 g/ m².
 Sac à Dos. 100% Coton 100 g/ m².
 Ruzzak. 100% Katoen 100 g/ m².

37 × 41 cm 250 / 50
 Print Code: F(6), N(8), O, P

**Serlen 1835**180 g/m²

Drawstring Bag. 100% Cotton 180 g/ m².
 Rucksack. 100% Baumwolle 180 g/ m².
 Sac à Dos. 100% Coton 180 g/ m².
 Ruzzak. 100% Katoen 180 g/ m².

37 × 41 cm 150 / 50
 Print Code: F(6), N(8), O, P

COTTON
& JUTTE

New



20

06

04

02

Badix 5982120 g/m²

Drawstring Bag. Jute/ Cotton 120 g/ m².
Rucksack. Jutestoff/ Baumwolle 120 g/ m².
Sac à Dos. Jute/ Coton 120 g/ m².
Rugzak. Jute/ Katoen 120 g/ m².

34 x 43 cm

100 / 10

Print Code: F(6), N(8), O, P

Zyndrax 20908120 g/m²

Drawstring Bag. Jute/ Cotton 120 g/ m².
Rucksack. Jutestoff/ Baumwolle 120 g/ m².
Sac à Dos. Jute/ Coton 120 g/ m².
Rugzak. Jute/ Katoen 120 g/ m².

34 x 43 cm

100 / 10

Print Code: F(6), N(8), O, P

New



03

Azurax 21131260 g/m²

Drawstring Bag. Polyester.
Rucksack. Polyester.
Sac à Dos. Polyester.
Rugzak. Polyester.

34 x 43 cm

100 / 10

Print Code: F(6), N(8), P



06

04

13

02

21

483

COTTON
& CORK**Galsin 6386**145 g/m²

Drawstring Bag. Cork/ Cotton 145 g/ m².
Rucksack. Kork/ Baumwolle 145 g/ m².
Sac à Dos. Liège/ Coton 145 g/ m².
Rugzak. Kurk/ Katoen 145 g/ m².

38 x 41 cm

100 / 10

Print Code: F(6), N(8), O, P



03



19

Vexira 20907

120 g/m²

Drawstring Bag. 100% Recycled Cotton 120 g/ m².
Rucksack. 100% Recycling Baumwolle 120 g/ m².
Sac à Dos. 100% Coton Recyclé 120 g/ m².
Rugzak. 100% Gerecycled Katoen 120 g/ m².

 38 x 42 cm  200 / 50
 Print Code: F(6), N(8), O, P

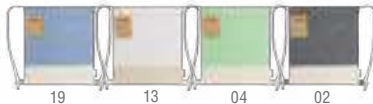

Konim 6392

120 g/m²

Drawstring Bag. 100% Recycled Cotton 120 g/ m².
Rucksack. 100% Recycling Baumwolle 120 g/ m².
Sac à Dos. 100% Coton Recyclé 120 g/ m².
Rugzak. 100% Gerecycled Katoen 120 g/ m².

 38 x 42 cm  100 / 50
 Print Code: F(6), N(8), O, P

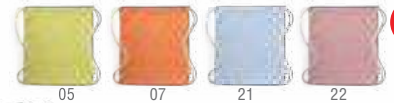
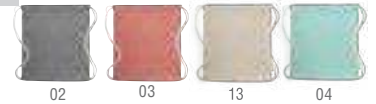

NEW COLOR



The Fairtrade Cotton label guarantees that the product comes from a traceable and sustainable sourcing chain and helps us to identify garments where 100% of the composition is traceable Fairtrade cotton. All of the cotton is Fairtrade certified, traded, audited and sourced from Fairtrade producers.

Visit www.info.fairtrade.net



03

New



04

Riak Fairtrade 20776

140 g/m²

Drawstring Bag. 100% Recycled Cotton 140 g/ m².
Rucksack Tasche. 100% Recycling Baumwolle 140 g/ m².
Sac à Dos. 100% Coton Recyclé 140 g/ m².
Rugzak Tas. 100% Gerecycled Katoen 140 g/ m².

 38 x 42 cm  100 / 50
 Print Code: F(6), N(8), O, P



Fenin 6833

140 g/m²

Drawstring Bag. 100% Recycled Cotton 140 g/ m².
Rucksack Tasche. 100% Recycling Baumwolle 140 g/ m².
Sac à Dos. 100% Coton Recyclé 140 g/ m².
Rugzak Tas. 100% Gerecycled Katoen 140 g/ m².

 38 x 42 cm  100 / 50
 Print Code: F(6), N(8), O, P



NEW COLOR



The Fairtrade Cotton label guarantees that the product comes from a traceable and sustainable sourcing chain and helps us to identify garments where 100% of the composition is traceable Fairtrade cotton. All of the cotton is Fairtrade certified, traded, audited and sourced from Fairtrade producers.

Visit www.info.fairtrade.net



Sanfer Fairtrade 1267

180 g/m²

Drawstring Bag. 100% Cotton 180 g/ m².
Rucksack. 100% Baumwolle 180 g/ m².
Sac à Dos. 100% Coton 180 g/ m².
Rugzak. 100% Katoen 180 g/ m².

38 x 42 cm 100 / 50 Print Code: F(6), N(8), O, P



Ferdin Fairtrade 1755

140 g/m²

Drawstring Bag. 100% Cotton 140 g/ m².
Rucksack. 100% Baumwolle 140 g/ m².
Sac à Dos. 100% Coton 140 g/ m².
Rugzak. 100% Katoen 140 g/ m².

38 x 42 cm 100 / 50 Print Code: F(6), N(8), O, P



13



Tibak 6390

120 g/m²

Drawstring Bag. 100% Organic Cotton 120 g/ m².
Rucksack. 100% Organische Baumwolle 120 g/ m².
Sac à Dos. 100% Coton Organique 120 g/ m².
Rugzak. 100% Organisch Katoen 120 g/ m².

38 x 42 cm 100 / 50 Print Code: F(6), N(8), O, P

ORGANIC COTTON



Maziu 1836

120 g/m²

Drawstring Bag. 100% Organic Cotton 120 g/ m².
Rucksack. 100% Organische Baumwolle 120 g/ m².
Sac à Dos. 100% Coton Organique 120 g/ m².
Rugzak. 100% Organisch Katoen 120 g/ m².

38 x 42 cm 100 / 50 Print Code: F(6), N(8), O, P



06



08



01



18



02

RECYCLED COTTON 



 Global Recycled Standard

New



Nidoran 1444 ⁰³

Backpack. 100% Recycled Cotton.
Rucksack. 100% Recycling Baumwolle.
Sac à Dos. 100% Coton Recyclé.
Rugzak. 100% Gerecycled Katoen.

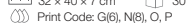
 32 x 40 x 7 cm  30  Print Code: G(6), N(8), O, P



13

19

02





13

02

Bigail 20901

19

Backpack. 100% Recycled Cotton. Padded Laptop and Tablet Compartment. Padded Back and Shoulder Straps.
Rucksack. 100% Recycling Baumwolle. Gepolsterte Laptotasche und Tablet. Gepolsterter Rücken und Schultergurte.
Sac à Dos. 100% Coton Recyclé. Pochette Rembourrée pour Portable et Tablette. Dos et Bretelles Rembourrées.
Rugzak. 100% Gerecycled Katoen. Gewatteerd Laptop en Tablet Compartment. Gewatteerde Achterzijde en Schouderbanden.

 32 x 42 x 10 cm  30  Print Code: G(6), N(8), O, P

 10"  15"
TABLET COMPARTMENT LAPTOP COMPARTMENT

ORGANIC COTTON 



Saunders 1837

Backpack. 100% Organic Cotton. Padded Back and Shoulder Straps.
Rucksack. 100% Organische Baumwolle. Gepolsterter Rücken und Schultergurte.
Sac à Dos. 100% Coton Organique. Dos et Bretelles Rembourrées.
Rugzak. 100% Organisch Katoen. Gewatteerde Achterzijde en Schouderbanden.

 34 x 43 x 9 cm  30  Print Code: G(6), N(8), O, P



Lagrit 1443

Backpack. 100% Organic Cotton.
Rucksack. 100% Organische Baumwolle.
Sac à Dos. 100% Coton Organique.
Rugzak. 100% Organisch Katoen.

 32 x 40 x 7 cm  30  Print Code: G(6), N(8), O, P





Lizcom 6432

Sublimation Drawstring Bag. Polyester.
 Sublimations Rucksack. Polyester.
 Sac à Dos Sublimation. Polyester.
 Sublimatie Rugzak. Polyester.



34 x 42 cm 100 / 10 Print Code: F(1), N(8), R

JUTTE &
COTTON

Lopso 6817

Duffel Bag. Jute/ Cotton.
 Seesack. Jutestoff/ Baumwolle.
 Balluchon. Jute/ Coton.
 Ptunjezak. Jute/ Katoen.



Ø 23 x 45 cm 50 / 10 Print Code: G(1), N(8), O

Marnel 6818

Backpack. Jute/ Cotton.
 Rucksack. Jutestoff/ Baumwolle.
 Sac à Dos. Jute/ Coton.
 Rugzak. Jute/ Katoen.



32 x 40 x 7 cm 50 / 10 Print Code: G(1), N(8), O





05F

Lemap 4520

Drawstring Bag, Polyester 190T, Reflective.
Rucksack, Polyester 190T, Reflektierend.
Sac à Dos, Polyester 190T, Réfléchissant.
Rugzak, Polyester 190T, Reflecterend.

35 x 41 cm 300 / 10
Print Code: F(1), N(8), R

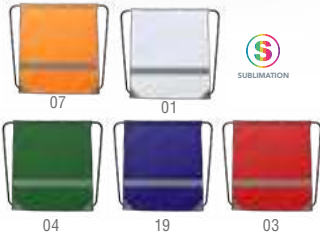

05

19

Nipex 5234

Drawstring Cool Bag, Polyester 210D/ Aluminium.
Kühltasche Rucksack, Polyester 210D/ Aluminium.
Sac à Dos Glacière, Polyester 210D/ Aluminium.
Koeltas-Rugzak, Polyester 210D/ Aluminium.

32 x 42 cm 200 / 10 Print Code: G(1)



03

Paxer 6632

Drawstring Bag, Polyester 210D.
Rucksack, Polyester 210D.
Sac à Dos, Polyester 210D.
Rugzak, Polyester 210D.

56 x 42 cm 300 / 10
Print Code: F(1), N(8), R



D

Naiper 5889

Drawstring Bag, Polyester 210D.
Rucksack, Polyester 210D.
Sac à Dos, Polyester 210D.
Rugzak, Polyester 210D.

42 x 43 cm 300 / 20 Print Code: F(1), N(8)



Kids



Tradan 5235

Drawstring Cool Bag. Polyester 210D/ Aluminium.
Kühltasche Rucksack. Polyester 210D/ Aluminium.
Sac à Dos Glacière. Polyester 210D/ Aluminium.
Koeltas-Rugzak. Polyester 210D/ Aluminium.

27 x 33 cm 200 / 10
Print Code: G(1)



Trokyn 6449

Drawstring Bag. Polyester 210D.
Rucksack. Polyester 210D.
Sac à Dos. Polyester 210D.
Rugzak. Polyester 210D.

31.5 x 42 cm 300 / 10
Print Code: F(1), N(8), R



Llorel 5705

Drawstring Bag. Polyester 210T.
Rucksack. Polyester 210T.
Sac à Dos. Polyester 210T.
Rugzak. Polyester 210T.

26 x 30 cm 500 / 10
Print Code: F(1), N(8)



Balard 1526

Drawstring Bag. Non-Woven RPET. 5 Crayons Included.
Rucksack. Non-Woven RPET. 5 Wachsmatstifte Inklusiv.
Sac à Dos. T.N.T. RPET. 5 Krijtjes Inclusief.
Rugzak. Non-Woven RPET. 5 Krijtjes Inclusief.

25 x 30 cm 200 / 50
Print Code: G(1)



RECYCLED COTTON



19



03

New

Dinki 5091

Drawstring Bag. Polyester 210D.
Rucksack. Polyester 210D.
Sac à Dos. Polyester 210D.
Rugzak. Polyester 210D.

27 x 32 cm 500 / 50
Print Code: F(1), N(8), R



Ashara 20393

Drawstring Bag. 100% Recycled Cotton.
Rucksack. 100% Recycling Baumwolle.
Sac à Dos. 100% Coton Recyclé.
Rugzak. 100% Gerecycled Katoen.

27 x 32 cm 150 / 50
Print Code: F(6), N(8), O, P



Susdal 6424

Backpack. Polyester 600D. Padded Back and Shoulder Straps.
Rucksack. Polyester 600D. Gepolsterter Rücken und Schultergurte.
Sac à Dos. Polyester 600D. Dos et Bretelles Rembourrées.
Rugzak. Polyester 600D. Gewatteerde Achterzijde en Schouderbanden.

25 x 30 x 12 cm 50
Print Code: G(1), N(8), O, P



04



Maggie 6987

Backpack. Polyester 600D RPET. Padded Back and Shoulder Straps.
Rucksack. Polyester 600D RPET. Gepolsterter Rücken und Schultergurte.
Sac à Dos. Polyester 600D RPET. Dos et Bretelles Rembourrées.
Rugzak. Polyester 600D RPET. Gewatteerde Achterzijde en Schouderbanden.

25 x 30 x 12 cm 50
Print Code: G(1), N(8), O



19



RPET



RECYCLED COTTON

New



Bolger 20902

06

Waistbag. 100% Recycled Cotton.
Gürteltasche. 100% Recycling Baumwolle.
Banane. 100% Coton Recyclé.
Heuptas. 100% Gerecycled Katoen.

25 x 17 x 8 cm 200 / 50 Print Code: F(1), N(8)



13



19



02



02

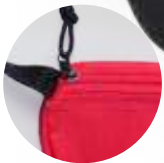

POCKET BACK

Zunder 6219

Waistbag. Polyester 600D.
Gürteltasche. Polyester 600D.
Banane. Polyester 600D.
Heuptas. Polyester 600D.

25 x 17 x 8 cm 200 / 50
Print Code: F(1), N(8)



06



07



16



19



03



Parks 6840

Waistbag. Polyester 600D RPET.
Gürteltasche. Polyester 600D RPET.
Banane. Polyester 600D RPET.
Heuptas. Polyester 600D RPET.

25 x 17 x 8 cm 200 / 50 Print Code: F(1), N(8)







 RPET

New

Vexen 20898

Shoulder Bag Waistbag. Polyester 600D RPET.
 Umhängetasche Gürteltasche. Polyester 600D RPET.
 Banane Bandoulière. Polyester 600D RPET.
 Heuptas Schoudertas. Polyester 600D RPET.



 19.5 x 13 x 6 cm  200 / 25  Print Code: F(1), N(8)



New

Stiva 20899

Shoulder Bag Waistbag. Polyester 600D RPET.
 Umhängetasche Gürteltasche. Polyester 600D RPET.
 Banane Bandoulière. Polyester 600D RPET.
 Heuptas Schoudertas. Polyester 600D RPET.

 34 x 17 x 11 cm  100 / 20
 Print Code: F(1), N(8)



Versox 6218

Shoulder Bag. Polyester 300D. USB Connection. Padded.
 Umhängetasche. Polyester 300D. USB Anschluss. Gepolstert.
 Bandoulière. Polyester 300D. Connexion USB. Rembourrée.
 Schoudertas. Polyester 300D. USB Verbinding. Gewatteerd.



 20 x 29 x 6.5 cm  50  Print Code: F(1), N(8)



New

Fadaok 21173

Shoulder Bag. Polyester. Padded. Reflective.
 Umhängetasche. Polyester. Gepolstert. Reflektierender.
 Bandoulière. Polyester. Rembourré. Réfléchissant.
 Schoudertas. Polyester. Gewatteerd. Reflecterend.

 16 x 36.5 x 4 cm  50
 Print Code: F(1), N(8)





16



03

Mendel 6375

Waistbag, Ripstop.
Gürteltasche, Ripstop.
Banane, Ripstop.
Heuptas, Ripstop.

31 x 11.5 cm 100 / 50 Print Code: F(1), N(8)



02

19

03

Crown 9639

Waistbag, Polyester 420D.
Gürteltasche, Polyester 420D.
Banane, Polyester 420D.
Heuptas, Polyester 420D.

29 x 10 x 6 cm 200 / 10 Print Code: F(1), N(8)



19



02



Basset 1620

Waistbag, Soft Shell, Reflective.
Gürteltasche, Soft Shell, Reflektierender.
Banane, Soft Shell, Réfléchissant.
Heuptas, Soft Shell, Reflecterend.

38.5 x 9.5 cm 100 / 50 Print Code: N(8)



19

Tildak 5502

Waistbag, Polyester 210D, Padded Back.
Gürteltasche, Polyester 210D, Gepolsteter Rücken.
Banane, Polyester 210D, Dos Rembourré.
Heuptas, Polyester 210D, Gewatteerde Achterzijde.

27 x 18 cm 200 / 10 Print Code: F(1), N(8)



04

02

03



Simun 20896

Shoulder Bag. Polyester 600D RPET.
Umhängetasche. Polyester 600D RPET.
Bandoulière. Polyester 600D RPET.
Schoudertas. Polyester 600D RPET.

17 x 19 x 4.5 cm 100 / 25 Print Code: F(1), N(8)



Lixia 20897

Shoulder Bag. Polyester 600D RPET.
Umhängetasche. Polyester 600D RPET.
Bandoulière. Polyester 600D RPET.
Schoudertas. Polyester 600D RPET.

16 x 21 x 5 cm 50 Print Code: F(1), N(8)



Landry 1838

Multipurpose Bag. Polyester 600D RPET.
Mehrzwecktasche. Polyester 600D RPET.
Fourre-Tout. Polyester 600D RPET.
Multifunctioneel Tasje. Polyester 600D RPET.

11.5 x 19.5 x 2 cm 200 / 50
Print Code: F(1), N(8), R



Hulak 21248

Holder Lanyard. Polyester.
Halter Schlüsselband. Polyester.
Lanyard Support. Polyester.
Holder Lanyard. Polyester.

12.5 x 18.5 cm 500 / 100
Print Code: N(8)

Lourdel 1839

Shoulder Bag. Polyester 600D RPET. Padded.
Umhängetasche. Polyester 600D RPET. Gepolstert.
Bandoulière. Polyester 600D RPET. Rembourrée.
Schoudertas. Polyester 600D RPET. Gewatteerd.

36 x 27 x 8 cm 30 Print Code: G(1), N(8)



100% COTTON



Gibons 20929

Lanyard. Cotton/ Bamboo. Safety Catch.
Schlüsselband. Baumwolle/ Bambus.
Sicherheitsverschluss.
Lanyard. Coton/ Bambou. Fermeture Sécurité.
Lanyard. Katoen/ Bamboe. Veiligheidssluiting.

3.2 x 50 cm 600 / 100
Print Code: D(1), L1



Denain 1543

Lanyard. 100% Cotton/ Wheat Straw/ ABS. Safety Catch.
Schlüsselband. 100% Baumwolle/ Weizenstroh/ ABS.
Sicherheitsverschluss.
Lanyard. 100% Coton/ Paille de Blé/ ABS. Fermeture Sécurité.
Lanyard. 100% Katoen/ Tarwestro/ ABS.
Veiligheidssluiting.

3.2 x 50 cm 600 / 100
Print Code: D(4), V



Troix 6778

Lanyard. 100% Cotton/ Wheat Straw/ PP. Safety Catch.
Schlüsselband. 100% Baumwolle/ Weizenstroh/ PP.
Sicherheitsverschluss.
Lanyard. 100% Coton/ Paille de Blé/ PP. Fermeture Sécurité.
Lanyard. 100% Katoen/ Tarwestro/ PP.
Veiligheidssluiting.

2 x 50 cm 500 / 100
Print Code: G(1), N(8)

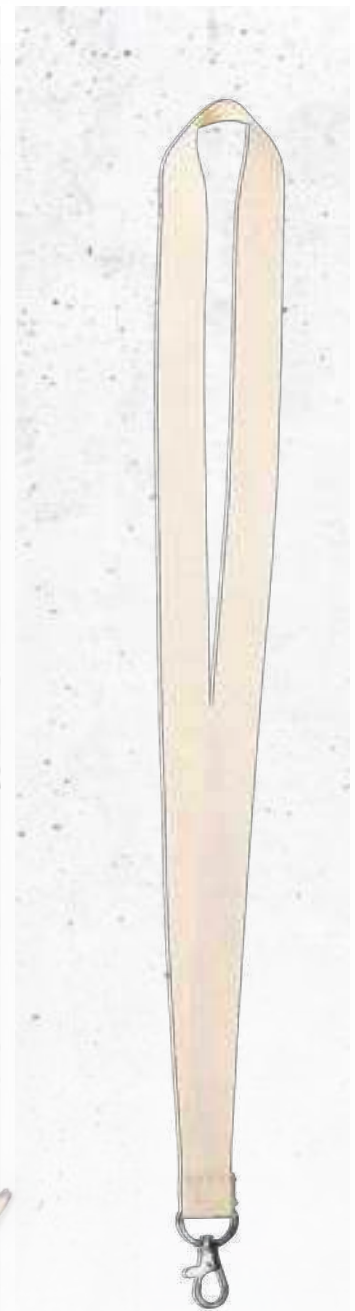

Mirok 6196

Lanyard. 100% Cotton.
Schlüsselband. 100% Baumwolle.
Lanyard. 100% Coton.
Lanyard. 100% Katoen.

2 x 50 cm 800 / 100
Print Code: G(1), N(8)

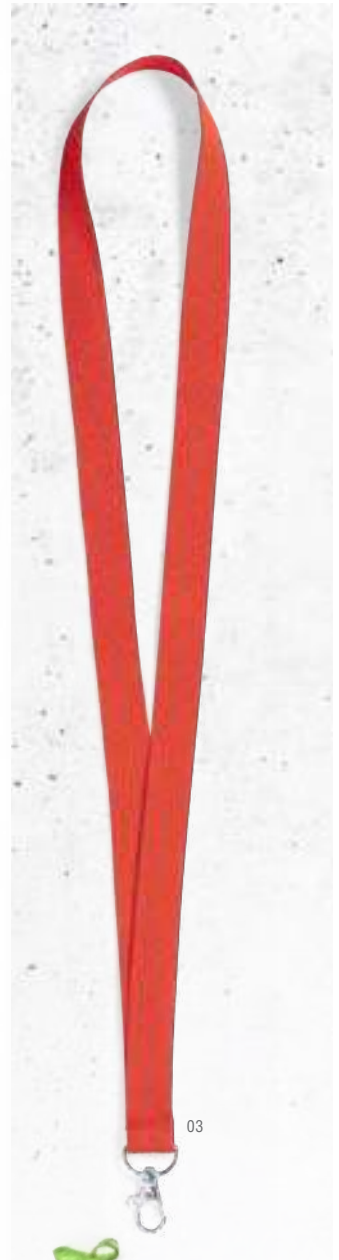

Kappin 6102

Lanyard. Polyester. Safety Catch.
 Schlüsselband. Polyester. Sicherheitsverschluss.
 Lanyard. Polyester. Fermeture Sécurité.
 Lanyard. Polyester. Veiligheidssluiting.



2 x 50 cm 800 / 100
 Print Code: G(1), N(8), R

Kunel 6415

Lanyard. Polyester.
 Schlüsselband. Polyester.
 Lanyard. Polyester.
 Lanyard. Polyester.



2 x 55 cm 600 / 100
 Print Code: G(1), N(8), R

Loriet 1544

Lanyard. Polyester RPET.
 Schlüsselband. Polyester RPET.
 Lanyard. Polyester RPET.
 Lanyard. Polyester RPET.



2 x 50 cm 800 / 100
 Print Code: G(1), N(8), R

Neck 8780

Lanyard. Polyester.
 Schlüsselband. Polyester.
 Lanyard. Polyester.
 Lanyard. Polyester.



2 x 50 cm 800 / 100 Print Code: G(1), N(8), R



Perux 5047

Lanyard. Polyester. Safety Catch.
Schlüsselband. Polyester. Sicherheitsverschluss.
Lanyard. Polyester. Fermeture Sécurité.
Lanyard. Polyester. Veiligheidssluiting.

3.2 x 50 cm 600 / 100
Print Code: D(1), V



Bespal 6779

Lanyard. Cork/ Wheat Straw/ PP. Safety Catch.
Schlüsselband. Kork/ Weizenstroh/ PP. Sicherheitsverschluss.
Lanyard. Liège/ Paille de Blé/ PP. Fermeture Sécurité.
Lanyard. Kurk/ Tarwestro/ PP. Veiligheidssluiting.

2 x 48 cm 600 / 100
Print Code: G(1), N(6)



Nerthus 1864

Lanyard. Recycled Cardboard.
Schlüsselband. Recycling Pappe.
Lanyard. Carton Recyclé.
Lanyard. Gerecycled Karton.

2 x 50 cm 800 / 200
Print Code: G(1)



Mapik 20930

Lanyard. Polyester. Safety Catch.
Schlüsselband. Polyester. Sicherheitsverschluss.
Lanyard. Polyester. Fermeture Sécurité.
Lanyard. Polyester. Veiligheidssluiting.

2 x 50 cm 800 / 100
Print Code: G(1), N(6)



Waylen 5852



Sublimation Bracelet, Polyester.
Sublimations Armband, Polyester.
Bracelet Sublimation, Polyester.
Sublimatie Armband, Polyester.

30 x 1.5 cm Print Code: R



Nopak 5454



Sublimation Lanyard, Polyester.
Sublimations Schlüsselband, Polyester.
Lanyard Sublimation, Polyester.
Sublimatie Lanyard, Polyester.

2.5 x 50 cm 500 / 100 Print Code: R



Lerop 2598



Sublimation Lanyard, Polyester.
Sublimations Schlüsselband, Polyester.
Lanyard Sublimation, Polyester.
Sublimatie Lanyard, Polyester.

2.5 x 100 cm 500 Print Code: R

Id Badge Lanyard



New

New

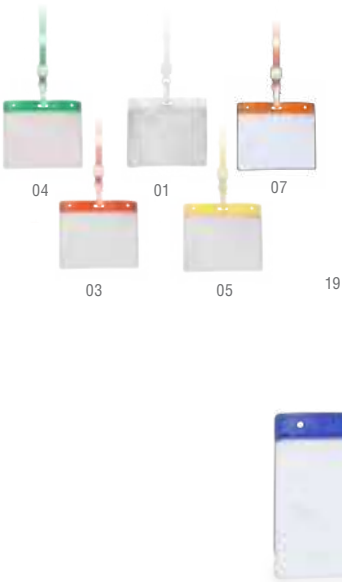

04

01

07

03

05

19

Maes 3709

Id Badge Lanyard. Polyester/ PVC.
 Namensschild Schlüsselband. Polyester/ PVC.
 Lanyard Porte-Badge. Polyester/ PVC.
 Badge Lanyard. Polyester/ PVC.

11 x 58 cm 1000 / 100 Print Code: G(1), D(1)



19

06

01

03

02

Fleck 20931

Id Badge Lanyard. Polyester/ PVC.
 Namensschild Schlüsselband. Polyester/ PVC.
 Lanyard Porte-Badge. Polyester/ PVC.
 Badge Lanyard. Polyester/ PVC.

7 x 54 cm 600 / 100 Print Code: G(1), N(8)

**Beryel 20916**

Id Badge Lanyard. Cork.
 Namensschild Schlüsselband. Kork.
 Lanyard Porte-Badge. Liège.
 Badge Lanyard. Kurk.

7.3 x 62 cm 400 / 50
 Print Code: D(1), G(1), L1, N(8)



Skoll 20639

Id Badge. PVC.
Namensschild. PVC.
Badge. PVC.
Id Badge. PVC.

11.3 x 18 cm 1000 / 200 Print Code: C(1)



Bizzot 4826

Id Badge. PVC.
Namensschild. PVC.
Badge. PVC.
Id Badge. PVC.

8.4 x 12.1 cm 2000 / 200 Print Code: C(1)



Ifem 9169

Id Badge. PVC.
Namensschild. PVC.
Badge. PVC.
Id Badge. PVC.

10 x 9 cm 2000 / 200 Print Code: C(1)



SEED PAPER
INCLUDED



Binem 2643 Made in Europe

Seeds Id Badge. Recycled Cardboard. Card Seed Paper. Wildflowers.
Samen Namensschild. Recycling Pappe. Samenpapier-Karte. Wilde Blumen.
Badge Ensemencé. Carton Recyclé. Carte Papier Ensemencé. Fleurs Sauvages.
Zaad Id Badge. Gerecycled Karton. Kaart Zaadpapier. Wilde Bloemen.

11.3 x 9.3 cm 1000 / 250 Print Code: B(1)

Tures 1865

Id Badge. Recycled Cardboard.
Namensschild. Recycling Pappe.
Badge. Carton Recyclé.
Id Badge. Gerecycled Karton.

11.5 x 9.2 cm 2000 / 500 Print Code: B(1)



03

Alter 4344

Id Badge. PVC.
Namensschild. PVC.
Badge. PVC.
Id Badge. PVC.

11 x 9.5 cm 1000 / 100 Print Code: C(1)



MATERIALS



ACCESSORIES

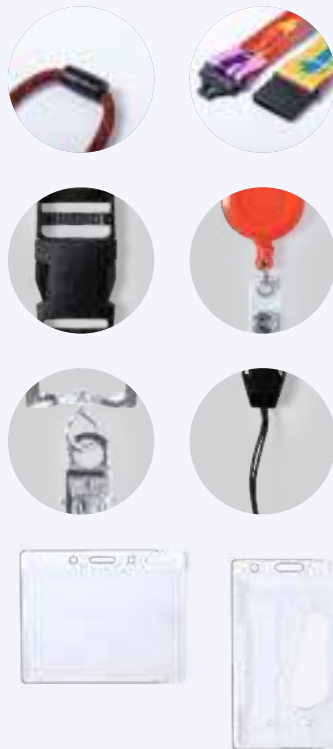

Create your own lanyard: choose material, accessories and design, we'll make it possible



DIRECT IMPORTS SERVICE

Fully customizable:
send your idea
and we'll make it
happen



06 DRINKWARE





RECYCLED DOUBLE WALL STAINLESS STEEL



500 ml



Hilker 20708



Insulated Bottle. Recycled Stainless Steel. 500 ml.
Wärme Flasche. Recycling Rostfreier Stahl. 500 ml.
Bidon Thermique. Acier Inox Recyclé. 500 ml.
Thermoskan-Fles. Gerecycled Roestvrij Staal. 500 ml.

Ø 7.3 × 22.7 cm 30
Print Code: F(1), L2, L3, WR



800 ml



Atinger 21029



Insulated Cup. Recycled Stainless Steel. 800 ml.
Wärme Trinkbecher. Recycling Rostfreier Stahl. 800 ml.
Verre Thermique. Acier Inox Recyclé. 800 ml.
Beker-Fles. Gerecycled Roestvrij Staal. 800 ml.

Ø 10 × 20 cm 25
Print Code: F(1), L1



340 ml



Yarton 21028



Insulated Cup. Recycled Stainless Steel. 340 ml.
Wärme Trinkbecher. Recycling Rostfreier Stahl. 340 ml.
Verre Thermique. Acier Inox Recyclé. 340 ml.
Beker-Fles. Gerecycled Roestvrij Staal. 340 ml.

Ø 8.7 × 11.8 cm 50
Print Code: F(1), L1



370 ml



Doverly 21030



Insulated Mug. Recycled Stainless Steel. 370 ml.
Wärme Tasse. Recycling Rostfreier Stahl. 370 ml.
Tasse Thermique. Acier Inox Recyclé. 370 ml.
Thermoskan-Mok. Gerecycled Roestvrij Staal. 370 ml.

Ø 8.8 × 12.1 cm 25
Print Code: F(1), L1

RECYCLED STAINLESS STEEL & CORK

DOUBLE WALL



New
COLD DRINK
HOT DRINK
450 ml



New
COLD DRINK
HOT DRINK
350 ml



New
COLD DRINK
HOT DRINK
500 ml



Frilan 20707



Insulated Mug. Recycled Stainless Steel/ Cork. 450 ml.
Wärme Tasse. Recycling Rostfreier Stahl/ Kork. 450 ml.
Tasse Thermique. Acier Inox Recyclé/ Liège. 450 ml.
Thermoskan-Mok. Gerecycled Roestvrij Staal/ Kurk. 450 ml.

Ø 7.9 x 17.6 cm 30 Print Code: F(1), L1



Sarski 21026



Insulated Cup. Recycled Stainless Steel/ Cork. 350 ml.
Wärme Trinkbecher. Recycling Rostfreier Stahl/ Kork. 350 ml.
Verre Thermique. Acier Inox Recyclé/ Liège. 350 ml.
Beker-Fles. Gerecycled Roestvrij Staal/ Kurk. 350 ml.

Ø 8.7 x 13.2 cm 25 Print Code: F(1), L1, WR

Dagles 21027



Insulated Bottle. Recycled Stainless Steel/ Cork. 500 ml.
Wärme Flasche. Recycling Rostfreier Stahl/ Kork. 500 ml.
Bidon Thermique. Acier Inox Recyclé/ Liège. 500 ml.
Thermoskan-Fles. Gerecycled Roestvrij Staal/ Kurk. 500 ml.

Ø 7 x 27.2 cm 25 Print Code: F(1), L2, L3, WR

RECYCLED Stainless Steel



Keono 20715



Insulated Bottle. Recycled Stainless Steel. 500 ml.
Wärme Flasche. Recycling Rostfreier Stahl. 500 ml.
Bidon Thermique. Acier Inox Recyclé. 500 ml.
Thermoskan-Fles. Gerecycled Roestvrij Staal. 500 ml.

Ø 7.2 × 22.7 cm 30
Print Code: F(1), L2, L3, WR

Prismix 21065



Insulated Bottle. Recycled Stainless Steel. 500 ml.
Wärme Flasche. Recycling Rostfreier Stahl. 500 ml.
Bidon Thermique. Acier Inox Recyclé. 500 ml.
Thermoskan-Fles. Gerecycled Roestvrij Staal. 500 ml.

Ø 7.2 × 22.6 cm 25
Print Code: F(1), L2, L3

Breidy 1767



Insulated Bottle. Recycled Stainless Steel. 500 ml.
Wärme Flasche. Recycling Rostfreier Stahl. 500 ml.
Bidon Thermique. Acier Inox Recyclé. 500 ml.
Thermoskan-Fles. Gerecycled Roestvrij Staal. 500 ml.

Ø 7.2 × 23 cm 30
Print Code: F(1), L2, L3, WR

Nimay 1766



Insulated Bottle. Recycled Stainless Steel. 380 ml.
Wärme Flasche. Recycling Rostfreier Stahl. 380 ml.
Bidon Thermique. Acier Inox Recyclé. 380 ml.
Thermoskan-Fles. Gerecycled Roestvrij Staal. 380 ml.

Ø 6 × 23 cm 40
Print Code: F(1), L2, L3, WR

Stainless Steel & Bamboo

300 ml

500 ml



New

New

500 ml

300 ml



Debris 20733

Set. Stainless Steel/ Bamboo. Insulated Bottle 500 ml.
Insulated Cup 300 ml.
Set. Rostfreier Stahl/ Bambus. Wärme Flasche 500 ml.
Wärme Trinkbecher 300 ml.
Set. Acier Inox/ Bambou. Bidon Thermique 500 ml. Verre
Thermique 300 ml.
Set. Roestvrij Staal/ Bamboe. Borraccia Termica 500 ml.
Beker-Fles 300 ml.

9.3 x 30.5 x 9.3 cm  25
Print Code: G(1), L2, L3

Dickinson 20732

Set. Stainless Steel/ Bamboo. Insulated Bottle 500 ml. 2 Insulated Cup 300 ml.
Set. Rostfreier Stahl/ Bambus. Wärme Flasche 500 ml. 2 Wärme Trinkbecher 300 ml.
Set. Acier Inox/ Bambou. Bidon Thermique 500 ml. 2 Verre Thermique 300 ml.
Set. Roestvrij Staal/ Bamboe. Borraccia Termica 500 ml. 2 Beker-Fles 300 ml.

25.8 x 9.5 x 21.4 cm  15  Print Code: G(1), L2, L3

Recycled Aluminium



01 02



05 02 01 03 04



02 09



01 09 03 19

Winex 20717

Bottle. Recycled Aluminium. 800 ml.
Trinkflasche. Recycling Aluminium. 800 ml.
Bidon. Aluminium Recyclé. 800 ml.
Fles. Gerecycled Aluminium. 800 ml.

Ø 7.2 × 24.5 cm 50
Print Code: F(1), L2, L3, WR

Perpok 20206

Bottle. Recycled Aluminium. 700 ml.
Trinkflasche. Recycling Aluminium. 700 ml.
Bidon. Aluminium Recyclé. 700 ml.
Fles. Gerecycled Aluminium. 700 ml.

Ø 7.3 × 25 cm 50
Print Code: F(1), L2, L3, WR

Zandor 20716

Bottle. Recycled Aluminium. 650 ml.
Trinkflasche. Recycling Aluminium. 650 ml.
Bidon. Aluminium Recyclé. 650 ml.
Fles. Gerecycled Aluminium. 650 ml.

Ø 7.3 × 21 cm 50
Print Code: F(1), L2, L3, WR

Claud 20207

Bottle. Recycled Aluminium/ Bamboo. 550 ml.
Trinkflasche. Recycling Aluminium/ Bambus. 550 ml.
Bidon. Aluminium Recyclé/ Bambou. 550 ml.
Fles. Gerecycled Aluminium/ Bamboe. 550 ml.

Ø 6.6 × 21 cm 50
Print Code: F(1), L2, L3, WR

Yaliz 1765

Bottle. Recycled Aluminium. 650 ml.
Trinkflasche. Recycling Aluminium. 650 ml.
Bidon. Aluminium Recyclé. 650 ml.
Fles. Gerecycled Aluminium. 650 ml.

☞ 6.6 x 23 cm ☞ 50
☞ Print Code: F(1), L2, L3, WR

NEW
COLOR



Seirex 1763

Bottle. Recycled Aluminium. 400 ml.
Trinkflasche. Recycling Aluminium. 400 ml.
Bidon. Aluminium Recyclé. 400 ml.
Fles. Gerecycled Aluminium. 400 ml.

☞ 6.6 x 17.5 cm ☞ 100 / 20
☞ Print Code: F(1), L2, L3, WR

Kristum 1764

Bottle. Recycled Aluminium. 750 ml.
Trinkflasche. Recycling Aluminium. 750 ml.
Bidon. Aluminium Recyclé. 750 ml.
Fles. Gerecycled Aluminium. 750 ml.

☞ 7.2 x 25.3 cm ☞ 50
☞ Print Code: F(1), L2, L3, WR

Recycled Aluminium



New

600 ml

Irvinson 21058

Bottle. Recycled Aluminium/ Bamboo. 600 ml.
Trinkflasche. Recycling Aluminium/ Bambus. 600 ml.
Bidon. Aluminium Recyclé/ Bambou. 600 ml.
Fles. Gerecycled Aluminium/ Bamboe. 600 ml.

☞ 6.6 x 22 cm ☞ 50
☞ Print Code: F(1), L2, L3, WR



Stainless Steel & Bamboo



600 ml



800 ml



750 ml



Dropun 6877

Bottle, Stainless Steel/ Bamboo, 600 ml.
Trinkflasche, Rostfreier Stahl/ Bambus, 600 ml.
Bidon, Acier Inox/ Bambou, 600 ml.
Fles, Roestvrij Staal/ Bamboe, 600 ml.

☞ Ø 6.3 × 21.7 cm ☞ 50 ☞ Print Code: F(1), L2, L3, WR



Gaucix 1476

Bottle, Stainless Steel/ Bamboo, 800 ml.
Trinkflasche, Rostfreier Stahl/ Bambus, 800 ml.
Bidon, Acier Inox/ Bambou, 800 ml.
Fles, Roestvrij Staal/ Bamboe, 800 ml.

☞ Ø 7.2 × 24.2 cm ☞ 30 ☞ Print Code: F(1), L2, L3, WR



Guiver 1057

Bottle, Stainless Steel/ Bamboo, 750 ml.
Trinkflasche, Acero Inox/ Bambú, 750 ml.
Bidon, Acier Inox/ Bambou, 750 ml.
Fles, Roestvrij Staal/ Bamboe, 750 ml.

☞ Ø 7.4 × 25.7 cm ☞ 50 ☞ Print Code: F(1), L2, L3, WR

Stainless Steel & Cork



750 ml



470 ml



750 ml



650 ml



INFUSER INCLUDED



Sereok 1058

Bottle. Stainless Steel/ Cork. 750 ml.
Trinkflasche. Rostfreier Stahl/ Kork. 750 ml.
Bidon. Acier Inox/ Liège. 750 ml.
Fles. Roestvrij Staal/ Kurk. 750 ml.

☞ Ø 7.4 × 25.7 cm ☞ 50
☞ Print Code: F(1), L2, L3, WR

Dantek 20713

Vacuum Flask. Stainless Steel/ Cork. 470 ml. Infuser Included.
Thermoskanne. Rostfreier Stahl/ Kork. 470 ml. Inklusive Teesieb.
Thermo. Acier Inox/ Liège. 470 ml. Infuseur Incluse.
Thermosfles. Roestvrij Staal/ Kurk. 470 ml. Thee-Ei Inclusief.

☞ Ø 6.5 × 24.7 cm ☞ 30
☞ Print Code: F(1), L2, L3, WR

Kraten 1770

Bottle. Stainless Steel/ Cork. 750 ml.
Trinkflasche. Rostfreier Stahl/ Kork. 750 ml.
Bidon. Acier Inox/ Liège. 750 ml.
Fles. Roestvrij Staal/ Kurk. 750 ml.

☞ Ø 7 × 27.5 cm ☞ 50
☞ Print Code: F(1), L2, L3, WR

Dixont 20714

Insulated Bottle. Stainless Steel/ Cork/ Bamboo. 650 ml.
Wärme Flasche. Rostfreier Stahl/ Kork/ Bambus. 650 ml.
Bidon Thermique. Acier Inox/ Liège/ Bambou. 650 ml.
Thermoskan-Fles. Roestvrij Staal/ Kurk/ Bamboe. 650 ml.

☞ Ø 7.2 × 26.7 cm ☞ 30
☞ Print Code: F(1), L2, L3, WR



COPPER VACUUM
INSULATED

500 ml



COPPER VACUUM INSULATED



02

04

19

09

23

03

01

Kungel 6858



Insulated Bottle. Stainless Steel. 500 ml. Copper Vacuum Insulated.
Wärme Flasche. Rostfreier Stahl. 500 ml. Kupfer Vakuumisoliert.
Bidon Thermique. Acier Inox. 500 ml. Isolation sous Vide en Cuivre.
Thermoskan-Fles. Roestvrij Staal. 500 ml. Koperen Vacuum Geïsoleerd.

Ø 7 x 26.3 cm 30 Print Code: F(1), L2, L3, WR



800 ml



01

02

06

Gristel 1045



Insulated Bottle. Stainless Steel. 800 ml. Copper Vacuum Insulated.
Wärme Flasche. Rostfreier Stahl. 800 ml. Kupfer Vakuumisoliert.
Bidon Thermique. Acier Inox. 800 ml. Isolation sous Vide en Cuivre.
Thermoskan-Fles. Roestvrij Staal. 800 ml. Koperen Vacuum Geïsoleerd.

Ø 7.7 x 26.5 cm 30 Print Code: F(1), L2, L3

COPPER VACUUM INSULATED

277

DRINKWARE



530 ml



09



750 ml



06



650 ml



23



02

01

23

Roach 1768



Insulated Bottle. Stainless Steel. 530 ml. Copper Vacuum Insulated.
Wärme Flasche. Rostfreier Stahl. 530 ml. Kupfer Vakuumisoliert.
Bidon Thermique. Acier Inox. 530 ml. Isolation sous Vide en Cuivre.
Thermoskan-Fles. Roestvrij Staal. 530 ml. Koperen Vacuüm Geïsoleerd.

Ø 6.7 x 24.7 cm 30 Print Code: F(1), L2, L3, WR



02

01

08

23

Willy 1769



Insulated Bottle. Stainless Steel. 750 ml. Copper Vacuum Insulated.
Wärme Flasche. Rostfreier Stahl. 750 ml. Kupfer Vakuumisoliert.
Bidon Thermique. Acier Inox. 750 ml. Isolation sous Vide en Cuivre.
Thermoskan-Fles. Roestvrij Staal. 750 ml. Koperen Vacuüm Geïsoleerd.

Ø 8 x 30.1 cm 30 Print Code: F(1), L2, L3, WR



06

08

01

02

Staver 6859



Insulated Bottle. Stainless Steel. 650 ml. Copper Vacuum Insulated.
Wärme Flasche. Rostfreier Stahl. 650 ml. Kupfer Vakuumisoliert.
Bidon Thermique. Acier Inox. 650 ml. Isolation sous Vide en Cuivre.
Thermoskan-Fles. Roestvrij Staal. 650 ml. Koperen Vacuüm Geïsoleerd.

Ø 7.3 x 27 cm 30 Print Code: F(1), L2, L3, WR

LIMITED
edition
EXPERIENCE

850 ml



600 ml

**Harriet 1667**

Bottle. Stainless Steel. 850 ml.
Trinkflasche. Rostfreier Stahl. 850 ml.
Bidon. Acier Inox. 850 ml.
Fles. Roestvrij Staal. 850 ml.

📏 Ø 7 x 25 cm 📦 30 🖨️ Print Code: F(1), L2

**Ninvux 1061**

Bottle. Stainless Steel/ Bamboo. 600 ml. Straw Pouch.
Trinkflasche. Rostfreier Stahl/ Bambus. 600 ml. Stroh Etui.
Bidon. Acier Inox/ Bambou. 600 ml. Étui Paille.
Fles. Roestvrij Staal/ Bamboe. 600 ml. Stro Zakje.

📏 Ø 7.2 x 21.2 cm 📦 50 🖨️ Print Code: F(1), L2



Stainless Steel ANTONIO MIRO

279



650 ml



500 ml



500 ml



750 ml

DRINKWARE



Xegaz 7377



Insulated Bottle. Stainless Steel. 650 ml.
Wärme Flasche. Rostfreier Stahl. 650 ml.
Bidon Thermique. Acier Inox. 650 ml.
Thermoskan-Fles. Roestvrij Staal. 650 ml.

Ø 7.5 × 24.1 cm 25
Print Code: F(1), L2, L3, WR



Kabol 7170



Vacuum Bottle. Stainless Steel. 500 ml.
Thermoskanne. Rostfreier Stahl. 500 ml.
Bidon Thermo. Acier Inox. 500 ml.
Thermoskan. Roestvrij Staal. 500 ml.

Ø 7.5 × 24.2 cm 30
Print Code: F(1), L2



Thomson 7360



Insulated Bottle. Stainless Steel. 500 ml.
Wärme Flasche. Rostfreier Stahl. 500 ml.
Bidon Thermique. Acier Inox. 500 ml.
Thermoskan-Fles. Roestvrij Staal. 500 ml.

Ø 7 × 25.4 cm 30
Print Code: F(1), L2, L3



Wilson 7361

Bottle. Stainless Steel. 750 ml.
Trinkflasche. Rostfreier Stahl. 750 ml.
Bidon. Acier Inox. 750 ml.
Fles. Roestvrij Staal. 750 ml.

Ø 7 × 27 cm 50
Print Code: F(1), L2



Electroplating
Copper
 Coating

Filix 1761

Bottle, Stainless Steel, 750 ml.
 Trinkflasche, Rostfreier Stahl, 750 ml.
 Bidon, Acier Inox, 750 ml.
 Fles, Roestvrij Staal, 750 ml.

Ø 7.3 × 22.5 cm 50
 Print Code: F(1), L2, L3, WR



Adbel 1760

Bottle, Stainless Steel, 790 ml.
 Trinkflasche, Rostfreier Stahl, 790 ml.
 Bidon, Acier Inox, 790 ml.
 Fles, Roestvrij Staal, 790 ml.

Ø 7.4 × 26.5 cm 50
 Print Code: F(1), L2, L3, WR



RUBBER FINISH

SPECIAL LASER ENGRAVING SILVER LOGO



These bottles have an outer coating specially designed for laser engraving, which will ensure that your advertising or brand is perfectly engraved in a shining silver colour.

Estos bidones tienen un recubrimiento exterior especialmente diseñados para grabado láser, con el que conseguirá que su publicidad o marca quede perfectamente grabada en color plata brillo.

750 ml



790 ml



02

08

06

01

Garthix 1833

Bottle. Stainless Steel. 750 ml.
Trinkflasche. Rostfreier Stahl. 750 ml.
Bidon. Acier Inox. 750 ml.
Fles. Roestvrij Staal. 750 ml.

📏 Ø 7.1 x 26.3 cm 📦 30
🖨️ Print Code: F(1), L2, WR

Jenings 1832

Bottle. Stainless Steel. 790 ml.
Trinkflasche. Rostfreier Stahl. 790 ml.
Bidon. Acier Inox. 790 ml.
Fles. Roestvrij Staal. 790 ml.

📏 Ø 7.4 x 25.7 cm 📦 50
🖨️ Print Code: F(1), L2, WR



02

08

06

01

TOUCH TEMPERATURE DISPLAY



New

500 ml



630 ml



New

500 ml



02

09

Troy 20213



Insulated Bottle. Stainless Steel. 630 ml. Touch Temperature Display.
Wärme Flasche. Rostfreier Stahl. 630 ml. Anzeige der Temperatur
auf Berührung.

Bidon Thermique. Acier Inox. 630 ml. Mesure de Température Tactile.
Thermoskan-Fles. Roestvrij Staal. 630 ml. Touch
Temperatuurweergave.

📏 Ø 7.1 x 23.3 cm 📖 30 🔄 Print Code: F(1), L2, L3, WR

Chuck 20214



Insulated Bottle. Stainless Steel. 500 ml. Touch Temperature Displ. Battery 80 mAh.
Wärme Flasche. Rostfreier Stahl. 500 ml. Anzeige der Temperatur auf Berührung.
Batterie 80 mAh.

Bidon Thermique. Acier Inox. 500 ml. Mesure de Température Tactile. Batterie 80 mAh.
Thermoskan-Fles. Roestvrij Staal. 500 ml. Touch Temperatuurweergave. Batterij 80 mAh.

📏 Ø 7 x 27.5 cm 📖 30 🔄 Print Code: F(1), L2, L3, WR

Kenay 1056



Insulated Bottle. Stainless Steel. 500 ml. Touch Temperature Display.
Wärme Flasche. Rostfreier Stahl. 500 ml. Anzeige der Berührungstemperatur.

Bidon Thermique. Acier Inox. 500 ml. Mesure de Température Tactile.
Thermoskan-Fles. Roestvrij Staal. 500 ml. Touch Temperatuurweergave.

📏 Ø 6.5 x 22.8 cm 📖 30 🔄 Print Code: F(1), L2

touch temperature display

390 ml



420 ml



New

450 ml



03



INFUSER INCLUDED -



DOUBLE INFUSER INCLUDED



INFUSER INCLUDED



Sutung 20731



Bekins 1051



Vacuum Flask. Borosilicate Glass/ Stainless Steel. 390 ml. Touch Temperature Display. Double Infuser Included.
 Thermoskanne. Borosilikat Glas/ Rostfreier Stahl. 390 ml. Anzeige der Berührungstemperatur. Inklusive Doppelt Teesieb.
 Thermo. Verre Borosilicate/ Acier Inox. 390 ml. Mesure de Température Tactile. Double Infuseur Inclus.
 Thermosfles. Borosilicate Glas/ Roestvrij Staal. 390 ml. Touch Temperatuurweergave. Double Thee-Ei Inclusief.

☞ Ø 6.6 x 23 cm ☞ 15 ☞ Print Code: F(1), L1

Kaucex 6863



Vacuum Flask. Stainless Steel. 420 ml. Touch Temperature Display. Infuser Included. Button Battery Included.
 Thermoskanne. Rostfreier Stahl. 420 ml. Anzeige der Temperatur auf Berührung. Inklusive Teesieb. Knopfzelle Inklusive.
 Thermo. Acier Inox. 420 ml. Mesure de Température Tactile. Infuseur Inclus. Pile Bouton Inclus.
 Thermosfles. Roestvrij Staal. 420 ml. Touch Temperatuurweergave. Thee-Ei Inclusief. Knoopcel Batterij Inclusief.

☞ Ø 6.5 x 24 cm ☞ 30 ☞ Print Code: F(1), L2, L3, WR



Vacuum Flask. Stainless Steel. 450 ml. Touch Temperature Display. Infuser Included. Button Battery Included.
 Thermoskanne. Rostfreier Stahl. 450 ml. Anzeige der Temperatur auf Berührung. Inklusive Teesieb. Knopfzelle Inklusive.
 Thermo. Acier Inox. 450 ml. Mesure de Température Tactile. Infuseur Inclus. Pile Bouton Inclus.
 Thermosfles. Roestvrij Staal. 450 ml. Touch Temperatuurweergave. Thee-Ei Inclusief. Knoopcel Batterij Inclusief.

☞ Ø 6.5 x 23 cm ☞ 30 ☞ Print Code: F(1), L2, L3, WR

Stainless Steel

DOUBLE WALL



Matner 20718



Insulated Bottle. Stainless Steel. 700 mL.
Wärme Flasche. Rostfreier Stahl. 700 mL.
Bidon Thermique. Acier Inox. 700 mL.
Thermoskan-Fles. Roestvrij Staal. 700 mL.

Ø 8.5 × 22.2 cm 15
Print Code: F(1), L2



Jokinen 20730



Vacuum Flask. Stainless Steel. 1 L. Glass 200 mL.
Thermoskanne. Rostfreier Stahl. 1 L. Trinkbecher 200 mL.
Thermo. Acier Inox. 1 L. Verre 200 mL.
Thermosfles. Roestvrij Staal. 1 L. Beker 200 mL.

Ø 9.3 × 32.2 cm 20 Print Code: F(1), L2



Tibber 20203



Vacuum Flask. Stainless Steel. 500 mL. Mug PP 130 mL Included.
Thermoskanne. Rostfreier Stahl. 500 mL. Tasse PP 130 mL Inklusief.
Thermo. Acier Inox. 500 mL. Tasse PP 130 mL Inclusive.
Thermosfles. Roestvrij Staal. 500 mL. Mok PP 130 mL Inclusief.

Ø 6.9 × 25.7 cm 30 Print Code: F(1), L2, L3, WR

Stainless Steel

DOUBLE WALL

285

DINKAWARE



500 ml



09



500 ml



05

.....● MATT FINISH

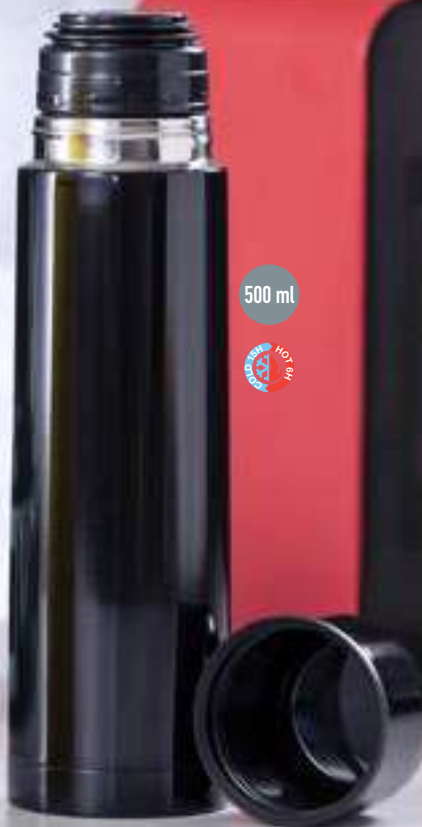

500 ml



02



330 ml



01

EASY OPENING



01 02 03 19

Plusek 6862



Vacuum Flask. Stainless Steel. 500 ml. Infuser Included.
Thermoskanne. Rostfreier Stahl. 500 ml. Inklusive Teesieb.
Thermo. Acier Inox. 500 ml. Infuseur Incluse.
Thermosfles. Roestvrij Staal. 500 ml. Thee-Ei Inclusief.

Ø 6 × 22.5 cm 30
Print Code: F(1), L2, L3, WR



11 08 02 01 19 03 04

Hosban 4875



Vacuum Flask. Stainless Steel. 500 ml.
Thermoskanne. Rostfreier Stahl. 500 ml.
Thermo. Acier Inox. 500 ml.
Thermosfles. Roestvrij Staal. 500 ml.

Ø 7 × 24.5 cm 30
Print Code: F(1), L2, WR



09 01 04 03 19 06 23

Tancher 6009



Vacuum Flask. Stainless Steel. 500 ml.
Thermoskanne. Rostfreier Stahl. 500 ml.
Thermo. Acier Inox. 500 ml.
Thermosfles. Roestvrij Staal. 500 ml.

Ø 7 × 24.5 cm 30
Print Code: F(1), L2, L3, WR



03 19 02 08

Poltax 6281



Vacuum Flask. Stainless Steel. 330 ml.
Thermoskanne. Rostfreier Stahl. 330 ml.
Thermo. Acier Inox. 330 ml.
Thermosfles. Roestvrij Staal. 330 ml.

Ø 5.7 × 23 cm 30
Print Code: F(1), L2, L3, WR

NEW COLOR

Double Wall

New

550 ml



03

500 ml



02

NEW COLOR



06

09

19

01

03



550 ml



19



06

02

03

09

01

Hexor 20712



Insulated Bottle. Stainless Steel. 550 ml.
Wärme Flasche. Rostfreier Stahl. 550 ml.
Bidon Thermique. Acier Inox. 550 ml.
Thermoskan-Fles. Roestvrij Staal. 550 ml.

Ø 7.3 × 24 cm 30
Print Code: F(1), L2



Naxel 1936



Insulated Bottle. Stainless Steel/ Bamboo. 500 ml.
Wärme Flasche. Rostfreier Stahl/ Bambus. 500 ml.
Bidon Thermique. Acier Inox/ Bambou. 500 ml.
Thermoskan-Fles. Roestvrij Staal/ Bamboe. 500 ml.

Ø 7.1 × 22.7 cm 30
Print Code: F(1), L2, L3, WR

Liyar 1937



Insulated Bottle. Stainless Steel. 550 ml.
Wärme Flasche. Rostfreier Stahl. 550 ml.
Bidon Thermique. Acier Inox. 550 ml.
Thermoskan-Fles. Roestvrij Staal. 550 ml.

Ø 7 × 26.5 cm 30
Print Code: F(1), L2, L3, WR



Barns 20710

Insulated Bottle. Stainless Steel/ Wood. 350 ml.
 Wärme Flasche. Rostfreier Stahl/ Holz. 350 ml.
 Bidon Thermique. Acier Inox/ Bois. 350 ml.
 Thermoskan-Fles. Roestvrij Staal/ Hout. 350 ml.

Ø 6.6 x 17.5 cm 50
 Print Code: F(1), L2, L3, WR



Flazer 20711

Insulated Bottle. Stainless Steel/ Bamboo. 350 ml.
 Wärme Flasche. Rostfreier Stahl/ Bambus. 350 ml.
 Bidon Thermique. Acier Inox/ Bambou. 350 ml.
 Thermoskan-Fles. Roestvrij Staal/ Bamboe. 350 ml.

Ø 7.3 x 17.8 cm 30
 Print Code: F(1), L2, L3, WR

FOLDABLE



Fael 20209

Foldable Bottle. Silicone/ Stainless Steel. 550 ml.
 Faltbare Trinkflasche. Silikon/ Rostfreier Stahl. 550 ml.
 Bidon Pliable. Silicone/ Acier Inox. 550 ml.
 Opvouwbare Fles. Siliconen/ Roestvrij Staal. 550 ml.

Ø 7.1 x 24.8 cm 50
 Print Code: L2



Klimt 20702

Foldable Cup. Silicone. 160 ml.
 Faltpbarer Trinkbecher. Silikon. 160 ml.
 Verre Pliable. Silicone. 160 ml.
 Opvouwbare Beker. Siliconen. 160 ml.

Ø 7.3 x 8.6 cm 200 / 100
 Print Code: F(1)

Double Wall



1.5 L



1 L



Talbot 1859



750 ml



500 ml



Gertok 1860



Insulated Bottle. Stainless Steel/ Bamboo. 1.5 L.
Wärme Flasche. Rostfreier Stahl/ Bambus. 1,5 L.
Bidon Thermique. Acier Inox/ Bambou. 1,5 L.
Thermoskan-Fles. Roestvrij Staal/ Bamboe. 1,5 L.

📏 Ø 10.1 × 31.5 cm 📦 20
🔗 Print Code: F(1), L2



Talbot 1859



Insulated Bottle. Stainless Steel/ Bamboo. 1 L.
Wärme Flasche. Rostfreier Stahl/ Bambus. 1 L.
Bidon Thermique. Acier Inox/ Bambou. 1 L.
Thermoskan-Fles. Roestvrij Staal/ Bamboe. 1 L.

📏 Ø 8.3 × 31 cm 📦 20
🔗 Print Code: F(1), L2



Guillon 1858



Insulated Bottle. Stainless Steel/ Bamboo. 750 ml.
Wärme Flasche. Rostfreier Stahl/ Bambus. 750 ml.
Bidon Thermique. Acier Inox/ Bambou. 750 ml.
Thermoskan-Fles. Roestvrij Staal/ Bamboe. 750 ml.

📏 Ø 7.7 × 26.3 cm 📦 25
🔗 Print Code: F(1), L2, L3, WR



Duky 1857



Insulated Bottle. Stainless Steel/ Bamboo. 500 ml.
Wärme Flasche. Rostfreier Stahl/ Bambus. 500 ml.
Bidon Thermique. Acier Inox/ Bambou. 500 ml.
Thermoskan-Fles. Roestvrij Staal/ Bamboe. 500 ml.

📏 Ø 7.2 × 21.4 cm 📦 30
🔗 Print Code: F(1), L2, L3, WR

Stainless Steel

Double Wall



Zolop 4976



Insulated Bottle. Stainless Steel. 850 ml.
Wärme Flasche. Rostfreier Stahl. 850 ml.
Bidon Thermique. Acier Inox. 850 ml.
Thermoskan-Fles. Roestvrij Staal. 850 ml.

Ø 8 x 30.5 cm 30 Print Code: F(1), L2, L3, WR

850 ml



830 ml



Rockorn



Higrif 1060



Insulated Bottle. Stainless Steel. 830 ml.
Wärme Flasche. Rostfreier Stahl. 830 ml.
Bidon Thermique. Acier Inox. 830 ml.
Thermoskan-Fles. Roestvrij Staal. 830 ml.

Ø 7.9 x 28.2 cm 30 Print Code: F(1), L2

I Have a Dream
MLK
Martin Luther King
DAY

Stainless Steel

**Tulman 6162**

Bottle. Stainless Steel/ Bamboo. 800 ml.
Trinkflasche. Rostfreier Stahl/ Bambus. 800 ml.
Bidon. Acier Inox/ Bambou. 800 ml.
Fles. Roestvrij Staal/ Bamboe. 800 ml.

☰ Ø 7.2 × 24.2 cm ☑ 30
☺ Print Code: F(1), L2, L3, WR

Rangler 6878

Bottle. Stainless Steel/ Bamboo. 800 ml.
Trinkflasche. Rostfreier Stahl/ Bambus. 800 ml.
Bidon. Acier Inox/ Bambou. 800 ml.
Fles. Roestvrij Staal/ Bamboe. 800 ml.

☰ Ø 7.2 × 24.2 cm ☑ 30
☺ Print Code: F(1), L2, L3, WR

Anukin 6530

Bottle. Stainless Steel. 770 ml.
Trinkflasche. Rostfreier Stahl. 770 ml.
Bidon. Acier Inox. 770 ml.
Fles. Roestvrij Staal. 770 ml.

☰ Ø 7.4 × 25.4 cm ☑ 50 / 25
☺ Print Code: F(1), L2, L3, WR

Jano 20738

DOUBLE WALL
Bottle. Stainless Steel/ Bamboo. 500 ml.
Sublimations Wärme Flasche. Rostfreier Stahl/ Bambus. 500 ml.
Bidon Thermique Sublimation. Acier Inox/ Bambou. 500 ml.
Sublimatie Thermoskan-Fles. Roestvrij Staal/ Bamboe. 500 ml.

☰ Ø 7.3 × 26 cm ☑ 30 ☺ Print Code: L2, Q

Stainless Steel



750 ml

02



800 ml

23



630 ml

09



790 ml

02



01



06 09 02 01



02 03 04 23 01



01 06 09 23



11 05 19 04 03 07



19

Pernal 6531

Bottle, Stainless Steel, 750 ml.
Trinkflasche, Rostfreier Stahl, 750 ml.
Bidon, Acier Inox, 750 ml.
Fles, Roestvrij Staal, 750 ml.

📏 $\varnothing 7 \times 24.2$ cm 📦 50 / 25
🖨️ Print Code: F(1), L2, L3, WR

Pigot 1395

Bottle, Stainless Steel, 800 ml.
Trinkflasche, Rostfreier Stahl, 800 ml.
Bidon, Acier Inox, 800 ml.
Fles, Roestvrij Staal, 800 ml.

📏 $\varnothing 7.3 \times 22.5$ cm 📦 50
🖨️ Print Code: F(1), L2, L3

Herilox 5827

Bottle, Stainless Steel, 630 ml.
Trinkflasche, Rostfreier Stahl, 630 ml.
Bidon, Acier Inox, 630 ml.
Fles, Roestvrij Staal, 630 ml.

📏 $\varnothing 7 \times 25$ cm 📦 50
🖨️ Print Code: F(1), L2, L3, WR

Rextan 6163

Bottle, Stainless Steel, 790 ml.
Trinkflasche, Rostfreier Stahl, 790 ml.
Bidon, Acier Inox, 790 ml.
Fles, Roestvrij Staal, 790 ml.

📏 $\varnothing 7.4 \times 25.7$ cm 📦 50
🖨️ Print Code: F(1), L2, L3, WR

Stainless Steel



Cheddy 1783

Bottle, Stainless Steel, 1,5 L.
Trinkflasche, Rostfreier Stahl, 1,5 L.
Bidon, Acier Inox, 1,5 L.
Fles, Roestvrij Staal, 1,5 L.

📏 Ø 8.4 × 32.2 cm 📦 40
🖨️ Print Code: F(1), L2, L3, WR



Whipet 1782

Bottle, Stainless Steel, 1 L.
Trinkflasche, Rostfreier Stahl, 1 L.
Bidon, Acier Inox, 1 L.
Fles, Roestvrij Staal, 1 L.

📏 Ø 7.3 × 28 cm 📦 50
🖨️ Print Code: F(1), L2, L3, WR



Karmel 1781

Bottle, Stainless Steel, 750 mL.
Trinkflasche, Rostfreier Stahl, 750 mL.
Bidon, Acier Inox, 750 mL.
Fles, Roestvrij Staal, 750 mL.

📏 Ø 7.3 × 22.3 cm 📦 50
🖨️ Print Code: F(1), L2, L3, WR



Dalber 1780

Bottle, Stainless Steel, 500 mL.
Trinkflasche, Rostfreier Stahl, 500 mL.
Bidon, Acier Inox, 500 mL.
Fles, Roestvrij Staal, 500 mL.

📏 Ø 7.3 × 19.5 cm 📦 50
🖨️ Print Code: F(1), L2, L3, WR

STAINLESS STEEL

293

DRINKWARE

PORTABLE HANDLE



600 ml



PORTABLE HANDLE

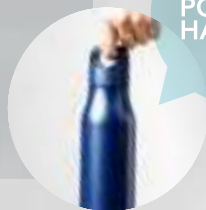

850 ml



Bucky 1794

Bottle, Stainless Steel, 600 ml.
Trinkflasche, Rostfreier Stahl, 600 ml.
Bidon, Acier Inox, 600 ml.
Fles, Roestvrij Staal, 600 ml.

06

01

02

08

☞ Ø 6.8 x 21.1 cm ☞ 50 / 25 ☞ Print Code: F(1), L2, L3, WR



Tocker 1795

Bottle, Stainless Steel, 850 ml.
Trinkflasche, Rostfreier Stahl, 850 ml.
Bidon, Acier Inox, 850 ml.
Fles, Roestvrij Staal, 850 ml.

06

01

02

08

☞ Ø 7.2 x 27.1 cm ☞ 50 ☞ Print Code: F(1), L2, L3, WR

STAINLESS STEEL PORTABLE HANDLE



New



New

550 ml



02



1L



DOUBLE WALL

Wanker 20720

Insulated Bottle. Stainless Steel. 1 L.
Wärme Flasche. Rostfreier Stahl. 1 L.
Bidon Thermique. Acier Inox. 1 L.
Thermoskan-Fles. Roestvrij Staal. 1 L.

📏 9 x 29.1 cm 📦 25 🖨️ Print Code: F(1)



01



08

02

01

Corvac 20719



DOUBLE WALL

Insulated Bottle. Stainless Steel. 550 ml.
Wärme Flasche. Rostfreier Stahl. 550 ml.
Bidon Thermique. Acier Inox. 550 ml.
Thermoskan-Fles. Roestvrij Staal. 550 ml.

📏 7.4 x 23 cm 📦 30 🖨️ Print Code: F(1)



06



04

02

06

New



500 ml

Flautrok 21123



Insulated Bottle. Stainless Steel. 500 ml. Glass PP 300 ml. Lanyard Included.
 Wärme Flasche. Rostfreier Stahl. 500 ml. Trinkbecher PP 300 ml. Schlüsselband Inklusive.
 Bidon Thermique. Acier Inox. 500 ml. Verre PP 300 ml. Lanyard Incluse.
 Thermoskan-Fles. Roestvrij Staal. 500 ml. Beker PP 300 ml. Lanyard Inclusief.

Ø 7.5 x 26 cm 30 Print Code: G(1), L2, N(8)



300 ml



High Capacity

1L



Alwey 1786

Bottle, Aluminium, 1 L.
Trinkflasche, Aluminium, 1 L.
Bidon, Aluminium, 1 L.
Fles, Aluminium, 1 L.



☞ Ø 8 × 26.5 cm ☞ 50 ☞ Print Code: F(1), L2, L3, WR

Pounder 1784

Bottle, Stainless Steel, 1 L.
Trinkflasche, Rostfreier Stahl, 1 L.
Bidon, Acier Inox, 1 L.
Fles, Roestvrij Staal, 1 L.



☞ Ø 8 × 31 cm ☞ 50 ☞ Print Code: F(1), L2, L3, WR

Heytun 1785

Bottle, Stainless Steel, 1 L.
Trinkflasche, Rostfreier Stahl, 1 L.
Bidon, Acier Inox, 1 L.
Fles, Roestvrij Staal, 1 L.



☞ Ø 8 × 31 cm ☞ 50 ☞ Print Code: F(1), L2, L3, WR

THE BEST PRICE



04 02 01 09 19 06 23

Carthy 1793

Bottle, Aluminium, 800 ml.
Trinkflasche, Aluminium, 800 ml.
Bidon, Aluminium, 800 ml.
Fles, Aluminium, 800 ml.

Ø 7.4 x 25.1 cm 50 Print Code: F(1), L2, L3, WR

800 ml



03



PORTABLE HANDLE

500 ml

04



09 02 01 03 19 06 23

Fecher 1792

Bottle, Aluminium, 500 ml.
Trinkflasche, Aluminium, 500 ml.
Bidon, Aluminium, 500 ml.
Fles, Aluminium, 500 ml.

Ø 6.6 x 20.8 cm 100 / 25 Print Code: F(1), L2, L3, WR

BOTTLE HANGER



Gotan 6499

Hanger, Silicone/ Aluminium.
Hänger, Silikon/ Aluminium.
Cintre, Silicone/ Aluminium.
Hanger, Siliconen/ Aluminium.

4.7 x 6.7 x 1 cm 1000 / 500
Print Code: C(1), L1



02

01

08



New

Grimg 20734

Cleaner Brush, 3 Functions.
Reinigungsbürste, 3 Funktionen.
Brosse Nettoyeur, 3 Fonctions.
Reinigings Borstel, 3 Functies.

3.4 x 12 x 2 cm 100 / 50
Print Code: C(4)



ALUMINIUM

**Raican 6883**

Bottle, Aluminium, 550 ml.
Trinkflasche, Aluminium, 550 ml.
Bidon, Aluminium, 550 ml.
Fles, Aluminium, 550 ml.

☞ Ø 6.6 × 22 cm ☞ 50
☞ Print Code: F(1), L2, L3, WR

**Tukel 5986**

Bottle, Aluminium, 650 ml.
Trinkflasche, Aluminium, 650 ml.
Bidon, Aluminium, 650 ml.
Fles, Aluminium, 650 ml.

☞ Ø 6.6 × 23 cm ☞ 50
☞ Print Code: F(1), L2, L3, WR

**Cartex 6323**

Bottle, Aluminium, 700 ml.
Trinkflasche, Aluminium, 700 ml.
Bidon, Aluminium, 700 ml.
Fles, Aluminium, 700 ml.

☞ Ø 6.9 × 25 cm ☞ 50
☞ Print Code: F(1), L2, L3, WR

**Runtex 6881**

Bottle, Aluminium, 600 ml.
Trinkflasche, Aluminium, 600 ml.
Bidon, Aluminium, 600 ml.
Fles, Aluminium, 600 ml.

☞ Ø 6.6 × 25 cm ☞ 50
☞ Print Code: F(1), L2, L3, WR



03 02 01 19 05 04 09 06

Delby 5491

Bottle. Aluminium. 800 ml.
 Trinkflasche. Aluminium. 800 ml.
 Bidon. Aluminium. 800 ml.
 Fles. Aluminium. 800 ml.

Ø 7.3 x 25.3 cm 50 Print Code: F(1), L2, L3, WR



02 09 19 05 23 06

07 11 03 04

Mento 3384

Bottle. Aluminium. 400 ml.
 Trinkflasche. Aluminium. 400 ml.
 Bidon. Aluminium. 400 ml.
 Fles. Aluminium. 400 ml.

Ø 6.6 x 17.5 cm 100 / 20 Print Code: F(1), L2, L3, WR



01 03 05 19

Henzo 4821

Bottle. Aluminium. 330 ml.
 Trinkflasche. Aluminium. 330 ml.
 Bidon. Aluminium. 330 ml.
 Fles. Aluminium. 330 ml.

Ø 6.6 x 15 cm 100 / 20 Print Code: F(1), L2, L3, WR



800 ml

Delby

23



400 ml

01



330 ml

Henzo

02

ALUMINIUM

800 ml



400 ml



500 ml

**Hetien 1364**

Bottle, Aluminium/ Bamboo, 800 ml.
 Trinkflasche, Aluminium/ Bambus, 800 ml.
 Bidon, Aluminium/ Bamboe, 800 ml.
 Fles, Aluminium/ Bamboe, 800 ml.

☞ Ø 7.3 × 24.7 cm ☞ 50 ☞ Print Code: F(1), L2, L3, WR

**Yorix 1365**

Bottle, Aluminium/ Bamboo, 400 ml.
 Trinkflasche, Aluminium/ Bambus, 400 ml.
 Bidon, Aluminium/ Bamboe, 400 ml.
 Fles, Aluminium/ Bamboe, 400 ml.

☞ Ø 6.6 × 17.2 cm ☞ 100/20 ☞ Print Code: F(1), L2, L3, WR

**Zambol 1787**

Bottle, Aluminium, 500 ml.
 Trinkflasche, Aluminium, 500 ml.
 Bidon, Aluminium, 500 ml.
 Fles, Aluminium, 500 ml.

☞ Ø 6.6 × 20.7 cm ☞ 50 ☞ Print Code: F(1), L2, L3, WR

Borosilicate Glass



550 ml



Krobus 1053

Bottle, Borosilicate Glass/ Stainless Steel, 550 ml.
Trinkflasche, Borosilikat Glas/ Rostfreier Stahl, 550 ml.
Bidon, Verre Borosilicate/ Acier Inox, 550 ml.
Fles, Borosilicate Glas/ Roestvrij Staal, 550 ml.

Ø 6.4 x 22.3 cm 30 Print Code: F(1), L1



500 ml



Kay 1390



Insulated Bottle, Borosilicate Glass/ Stainless Steel, 500 ml.
Wärme Flasche, Borosilikat Glas/ Rostfreier Stahl, 500 ml.
Bidon Thermique, Verre Borosilicate/ Acier Inox, 500 ml.
Thermoskan-Fles, Borosilicate Glas/ Roestvrij Staal, 500 ml.

Ø 7.8 x 25 cm 20 Print Code: F(1), L1



850 ml



Ivisur 1389

Bottle, Borosilicate Glass/ Stainless Steel, 850 ml.
Trinkflasche, Borosilikat Glas/ Rostfreier Stahl, 850 ml.
Bidon, Verre Borosilicate/ Acier Inox, 850 ml.
Fles, Borosilicate Glas/ Roestvrij Staal, 850 ml.

Ø 8 x 28 cm 20 Print Code: F(1), L2, L3



Trupak 6864

Bottle, Glass/ Bamboo, 500 ml. Cork Pouch.
Trinkflasche, Glas/ Bambus, 500 ml. Kork Etui.
Bidon, Verre/ Bambou, 500 ml. Étui Liège.
Fles, Glas/ Bamboe, 500 ml. Kurk Zakje.

📏 Ø 6.3 × 22.5 cm 📦 30
🖨️ Print Code: G(1), N(8)



Blorek 20162

Bottle, Glass/ Bamboo, 500 ml. Felt RPET Pouch.
Trinkflasche, Glas/ Bambus, 500 ml. Filz RPET Etui.
Bidon, Verre/ Bambou, 500 ml. Étui Feutrine RPET.
Fles, Glas/ Bamboe, 500 ml. Vilt RPET Zakje.

📏 Ø 6.4 × 23 cm 📦 30
🖨️ Print Code: G(1), L1, N(8)



Kasfol 6581

Bottle, Glass/ Bamboo, 500 ml. Polyester Pouch.
Trinkflasche, Glas/ Bambus, 500 ml. Polyester Etui.
Bidon, Verre/ Bambou, 500 ml. Étui Polyester.
Fles, Glas/ Bamboe, 500 ml. Polyester Zakje.

📏 Ø 6.3 × 22.5 cm 📦 30
🖨️ Print Code: G(1), L2, N(8)



Teltox 6866

Bottle, Glass/ Bamboo, 540 ml. Silicone Pouch.
Trinkflasche, Glas/ Bambus, 540 ml. Silikon Etui.
Bidon, Verre/ Bambou, 540 ml. Étui Silicone.
Fles, Glas/ Bamboe, 540 ml. Siliconen Zakje.

📏 Ø 6.7 × 23 cm 📦 30 🖨️ Print Code: G(1)



Glass & Soft Shell Pouch

303

DRINKWARE



Flaber 6870

Bottle. Glass. 600 ml. Soft Shell Pouch.
Trinkflasche. Glas. 600 ml. Soft Shell Etui.
Bidon. Verre. 600 ml. Étui Soft Shell.
Fles. Glas. 600 ml. Soft Shell Zakje.

☐ 8.5 x 16 cm 📦 40 🖨️ Print Code: G(1), L2, N(8), R



Dokath 5513

Bottle. Glass/ Stainless Steel. 420 ml. Soft Shell Pouch.
Trinkflasche. Glas/ Rostfreier Stahl. 420 ml. Soft Shell Etui.
Bidon. Verre/ Acier Inox. 420 ml. Étui Soft Shell.
Fles. Glas/ Roestvrij Staal. 420 ml. Soft Shell Zakje.

☐ 6.4 x 19 cm 📦 50 🖨️ Print Code: G(1), L2, N(8), R



Venen 20727

Bottle. Glass. 500 ml. Soft Shell Pouch.
Trinkflasche. Glas. 500 ml. Soft Shell Etui.
Bidon. Verre. 500 ml. Étui Soft Shell.
Fles. Glas. 500 ml. Soft Shell Zakje.

☐ 6.5 x 22.6 cm 📦 50 🖨️ Print Code: G(1), L2, N(8), R

GLASS

470 ml



500 ml



650 ml



02 03 07 19 01 16

Tinof 6868

Bottle, Glass, 470 ml.
Trinkflasche, Glas, 470 ml.
Bidon, Verre, 470 ml.
Fles, Glas, 470 ml.



☞ Ø 6.3 x 25 cm ☞ 30 ☞ Print Code: F(1), L2, WR



19 01 04 11 07 03

Terkol 6314

Bottle, Glass/ Stainless Steel, 500 ml.
Trinkflasche, Glas/ Rostfreier Stahl, 500 ml.
Bidon, Verre/ Acier Inox, 500 ml.
Fles, Glas/ Roestvrij Staal, 500 ml.

☞ Ø 6.3 x 22 cm ☞ 50 ☞ Print Code: F(1), L2, WR



16 19 07 02 01 03

Sunsox 6867

Bottle, Glass/ Stainless Steel, 650 ml.
Trinkflasche, Glas/ Rostfreier Stahl, 650 ml.
Bidon, Verre/ Acier Inox, 650 ml.
Fles, Glas/ Roestvrij Staal, 650 ml.

☞ Ø 7.1 x 25.8 cm ☞ 30 ☞ Print Code: F(1), L2, WR

500 ml



Yonsol 1260

Bottle. Glass/ Bamboo. 500 ml. Not suitable for sublimation.
 Trinkflasche. Glas/ Bambus. 500 ml. Nicht geeignet für sublimation.
 Bidon. Verre/ Bambou. 500 ml. Ne convient pas à la sublimation.
 Fles. Glas/ Bamboe. 500 ml. Niet geschikt voor sublimatie.

Ø 6.3 × 22.5 cm 50 Print Code: F(t), WR

500 ml



Toniox 20726

Bottle. Glass/ Bamboo. 500 ml.
 Trinkflasche. Glas/ Bambus. 500 ml.
 Bidon. Verre/ Bambou. 500 ml.
 Fles. Glas/ Bamboe. 500 ml.

Ø 6 × 22.5 cm 30 Print Code: F(t), L2, WR

500 ml



02

19



01

03

Eskay 1811

Bottle. Glass/ Bamboo. 500 ml.
 Trinkflasche. Glas/ Bambus. 500 ml.
 Bidon. Verre/ Bambou. 500 ml.
 Fles. Glas/ Bamboe. 500 ml.

Ø 6.3 × 22.5 cm 50 Print Code: F(t), L1, L2, WR



04

500 ml



Kaory 1774

Sublimation Bottle. Glass/ Bamboo. 500 ml.
 Sublimations Trinkflasche. Glas/ Bambus. 500 ml.
 Bidon Sublimation. Verre/ Bambou. 500 ml.
 Sublimatie Fles. Glas/ Bamboe. 500 ml.

Ø 6.3 × 22.5 cm 50
 Print Code: F(t), L1, L2, Q, WR

500 ml



22

05

07

16

Vantex 20515

Sublimation Bottle. Glass/ Bamboo. 500 ml.
 Sublimations Trinkflasche. Glas/ Bambus. 500 ml.
 Bidon Sublimation. Verre/ Bambou. 500 ml.
 Sublimatie Fles. Glas/ Bamboe. 500 ml.

Ø 6.3 × 22.5 cm 50
 Print Code: L1, L2, Q

New



21



05

04



03

21

Nortalik 21101

Bottle. Glass/ Stainless Steel. 500 ml.
 Trinkflasche. Glas/ Rostfreier Stahl. 500 ml.
 Bidon. Verre/ Acier Inox. 500 ml.
 Fles. Glas/ Roestvrij Staal. 500 ml.

Ø 6.3 × 22.5 cm 30
 Print Code: F(t), L2, WR

New

500 ml



11

306 **Aderox 1788**

DRINKWARE

Bottle. Glass/ Bamboo/ Cork. 470 ml.
 Trinkflasche. Glas/ Bambus/ Kork. 470 ml.
 Bidon. Verre/ Bambou/ Liège. 470 ml.
 Fles. Glas/ Bamboe/ Kurk. 470 ml.

Ø 6.5 x 23 cm 30
 Print Code: F(1), L2, WR



Aderox 1788

Nowslly 1789

Bottle. Glass/ Bamboo. 450 ml.
 Trinkflasche. Glas/ Bambus. 450 ml.
 Bidon. Verre/ Bambou. 450 ml.
 Fles. Glas/ Bamboe. 450 ml.

Ø 7.4 x 17.3 cm 30
 Print Code: F(1), L2



Nowslly 1789

Burdis 6198

Bottle. Glass/ Bamboo. 430 ml.
 Trinkflasche. Glas/ Bambus. 430 ml.
 Bidon. Verre/ Bambou. 430 ml.
 Fles. Glas/ Bamboe. 430 ml.

Ø 6.3 x 19 cm 50
 Print Code: F(1), L2, WR



Burdis 6198

Lurok 6582

Dinsak 2671

Lurok 6582



Bottle. Glass/ Bamboo. 530 ml. Soft Shell Pouch.
 Trinkflasche. Glas/ Bambus. 530 ml. Soft Shell Etui.
 Bidon. Verre/ Bambou. 530 ml. Étui Soft Shell.
 Fles. Glas/ Bamboe. 530 ml. Soft Shell Zakje.

Ø 6.3 x 22.5 cm 30
 Print Code: G(1), L2, N(8), R

Made in Europe

Dinsak 2671

Bottle. Glass. 785 ml.
 Trinkflasche. Glas. 785 ml.
 Bidon. Verre. 785 ml.
 Fles. Glas. 785 ml.

Ø 8.1 x 22.6 cm 30
 Print Code: F(1), L2

BAMBOO & Stainless steel



Tiaky 6603



Vacuum Flask. Bamboo/ Stainless Steel. 420 ml.
 Thermoskanne. Bambus/ Rostfreier Stahl. 420 ml.
 Thermo. Bambou/ Acier Inox. 420 ml.
 Thermosfles. Bamboe/ Roestvrij Staal. 420 ml.

Ø 6.5 x 25.5 cm 30 Print Code: F(1), L2



INFUSER INCLUDED

Bridget 1059



Vacuum Flask. Bamboo. 400 ml. Infuser Included.
 Thermoskanne. Bambus. 400 ml. Inklusive Teesieb.
 Thermo. Bambou. 400 ml. Infuseur Inclusive.
 Thermosfles. Bamboe. 400 ml. Thee-Ei Inclusief.

Ø 7 x 22.3 cm 30 Print Code: F(1), L2



Moltex 6156



Vacuum Flask. Bamboo/ Stainless Steel. 500 ml.
 Thermoskanne. Bambus/ Rostfreier Stahl. 500 ml.
 Thermo. Bambou/ Acier Inox. 500 ml.
 Thermosfles. Bamboe/ Roestvrij Staal. 500 ml.

Ø 6.9 x 24.5 cm 30 Print Code: F(1), L2



19

21



01

02

04

Katsur 20724

Bottle, RPET, 370 ml.
Trinkflasche, RPET, 370 ml.
Bidon, RPET, 370 ml.
Fles, RPET, 370 ml.

📏 Ø 6.5 × 16.1 cm 📦 50 🔄 Print Code: F(1)

New



03



Products of food grade
quality certified.



02

04

01

Tournax 21053

Bottle, RPET/ Bamboo, 650 ml.
Trinkflasche, RPET/ Bambus, 650 ml.
Bidon, RPET/ Bambou, 650 ml.
Fles, RPET/ Bamboe, 650 ml.

📏 Ø 7 × 22.5 cm 📦 50 🔄 Print Code: F(1), WR

650 ml



19

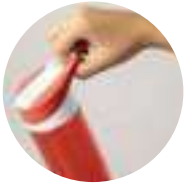

New

600 ml



02

07

01

03

08

Laudon 20721

Bottle, RPET, 600 ml.
Trinkflasche, RPET, 600 ml.
Bidon, RPET, 600 ml.
Fles, RPET, 600 ml.

📏 Ø 6.6 × 25 cm 📦 50 🔄 Print Code: F(1)



19



600 ml

Solarix 6874

Bottle, RPET/ Bamboo, 600 ml.
Trinkflasche, RPET/ Bambus, 600 ml.
Bidon, RPET/ Bambou, 600 ml.
Fles, RPET/ Bamboe, 600 ml.

📏 Ø 7 × 19.5 cm 📦 50 🔄 Print Code: F(1), L1





Products of food grade quality certified.



600 ml

16



830 ml

03



600 ml

19



01 21 19 07 02 03

Fiodor 1779

Bottle. RPET/ Stainless Steel. 600 ml.
Trinkflasche. RPET/ Rostfreier Stahl. 600 ml.
Bidon. RPET/ Acier Inox. 600 ml.
Fles. RPET/ Roestvrij Staal. 600 ml.

Ø 6.8 x 23.3 cm 50 Print Code: F(1), L1



21 01 02 04 19

Albrait 20723

Bottle. RPET. 830 ml.
Trinkflasche. RPET. 830 ml.
Bidon. RPET. 830 ml.
Fles. RPET. 830 ml.

Ø 7.5 x 25 cm 50 Print Code: F(1), L1



01 21 16 07 02 03

Lecit 6871

Bottle. RPET/ Stainless Steel. 600 ml.
Trinkflasche. RPET/ Rostfreier Stahl. 600 ml.
Bidon. RPET/ Acier Inox. 600 ml.
Fles. RPET/ Roestvrij Staal. 600 ml.

Ø 6.5 x 21 cm 50 Print Code: F(1), L1

tritan™

New

650 ml



19

600 ml



03

550 ml



02



01

02

03



Taney 20725

Bottle, Tritan. 650 ml.
Trinkflasche, Tritan. 650 ml.
Bidon, Tritan. 650 ml.
Fles, Tritan. 650 ml.

☞ Ø 6.6 × 25.5 cm ☞ 50 ☞ Print Code: F(1), WR



02

01

19

Trakex 2714 Made in Europe

Bottle, Tritan. 600 ml.
Trinkflasche, Tritan. 600 ml.
Bidon, Tritan. 600 ml.
Fles, Tritan. 600 ml.

☞ Ø 6.8 × 22.8 cm ☞ 30 ☞ Print Code: F(1), WR



19

01

03

Warlock 2713 Made in Europe

Bottle, Tritan. 550 ml.
Trinkflasche, Tritan. 550 ml.
Bidon, Tritan. 550 ml.
Fles, Tritan. 550 ml.

☞ Ø 7 × 19.8 cm ☞ 60 ☞ Print Code: F(1)



Rizbo 6872

Bottle. Tritan/ Stainless Steel. 500 ml.
 Trinkflasche. Tritan/ Rostfreier Stahl. 500 ml.
 Bidon. Tritan/ Acier Inox. 500 ml.
 Fles. Tritan/ Roestvrij Staal. 500 ml.

Ø 6.5 x 19.5 cm 50 Print Code: F(1), L1, WR

500 ml



Hanicol 6873

Bottle. Tritan/ Stainless Steel. 600 ml.
 Trinkflasche. Tritan/ Rostfreier Stahl. 600 ml.
 Bidon. Tritan/ Acier Inox. 600 ml.
 Fles. Tritan/ Roestvrij Staal. 600 ml.

Ø 7.2 x 22 cm 50 Print Code: F(1), L1, WR

600 ml

Rizbo 6872

Hanicol 6873

530 ml

Pruler 6297

Bottle. Tritan. 530 ml.
 Trinkflasche. Tritan. 530 ml.
 Bidon. Tritan. 530 ml.
 Fles. Tritan. 530 ml.

Ø 6.5 x 22 cm 50 Print Code: F(1), WR



03

07

01

19



04

100% COMPOSTABLE
BIODEGRADABLE

PLA

USE ME,
I AM ECO-FRIENDLY



830 ml



Kurtyl 6563



Kurtyl 6563

Bottle. PLA 100% Compostable. 830 ml.
Trinkflasche. PLA 100% Kompostierbar. 830 ml.
Bidon. PLA 100% Compostable. 830 ml.
Fles. PLA 100% Composteerbaar. 830 ml.

Ø 7 x 25.8 cm 30 Print Code: F(1)



ANTIBACTERIAL
FORMULA

600 ml

Gliter 6768

Antibacterial Bottle. PE/ Stainless Steel. 600 ml.
Antibakteriell Trinkflasche. PE/ Rostfreier Stahl. 600 ml.
Bidon Antibacterienne. PE/ Acier Inox. 600 ml.
Antibacterieel Fles. PE/ Roestvrij Staal. 600 ml.

Ø 6.5 x 21.2 cm 50 Print Code: F(1), L1





Wistel 1162

Bottle. PE/ Stainless Steel. 600 ml.
Trinkflasche. PE/ Rostfreier Stahl. 600 ml.
Bidon. PE/ Acier Inox. 600 ml.
Fles. PE/ Roestvrij Staal. 600 ml.

☞ Ø 6.5 × 21.2 cm ☞ 50 ☞ Print Code: F(1), L1

Herrax 1163

Bottle. PE/ Stainless Steel. 700 ml.
Trinkflasche. PE/ Rostfreier Stahl. 700 ml.
Bidon. PE/ Acier Inox. 700 ml.
Fles. PE/ Roestvrij Staal. 700 ml.

☞ Ø 7 × 25 cm ☞ 30 ☞ Print Code: F(1), L1

Stroud 20728

Bottle. PE/ Cork/ Stainless Steel. 650 ml.
Trinkflasche. PE/ Kork/ Rostfreier Stahl. 650 ml.
Bidon. PE/ Liège/ Acier Inox. 650 ml.
Fles. PE/ Kurk/ Roestvrij Staal. 650 ml.

☞ Ø 7 × 25 cm ☞ 50 ☞ Print Code: F(1), L1, WR



19

314 **Nolde 20722**

DRINKWARE

Bottle. Recycled Aluminium. 680 ml.
Trinkflasche. Recycling Aluminium. 680 ml.
Bidon. Aluminium Recyclé. 680 ml.
Fles. Gerecycled Aluminium. 680 ml.

Ø 7.3 x 22 cm 50 Print Code: F(1)



RECYCLED
aluminium

Barrister 5099

Bottle. Aluminium. 650 ml.
Trinkflasche. Aluminium. 650 ml.
Bidon. Aluminium. 650 ml.
Fles. Aluminium. 650 ml.

Ø 7.3 x 20.7 cm 50
Print Code: F(1), L2, L3, WR



Wanker 20720

Insulated Bottle. Stainless Steel. 1 L.
Wärme Flasche. Rostfreier Stahl. 1 L.
Bidon Thermique. Acier Inox. 1 L.
Thermoskan-Fles. Roestvrij Staal. 1 L.

Ø 9 x 29.1 cm 25
Print Code: F(1)



Smaly 6280

Bottle. Stainless Steel. 800 ml.
Trinkflasche. Rostfreier Stahl. 800 ml.
Bidon. Acier Inox. 800 ml.
Fles. Roestvrij Staal. 800 ml.

Ø 7.1 x 28 cm 30
Print Code: F(1), L2, L3



Alborez 20448

Bottle. RPET. 800 ml.
Trinkflasche. RPET. 800 ml.
Bidon. RPET. 800 ml.
Fles. RPET. 800 ml.

Ø 7.5 x 23.5 cm 50
Print Code: F(1)



SPORT
BOTTLE

01

Poel 20446

Foldable Bottle. TPU. 500 ml.
Faltbare Trinkflasche. TPU. 500 ml.
Bidon Pliable. TPU. 500 ml.
Opvouwbare Fles. TPU. 500 ml.

9.5 x 25 x 3.3 cm 250 / 50
Print Code: E(1)

500 ml



19



01

Sabik 20447

Foldable Cup. TPU. 230 ml.
Faltbarer Trinkbecher. TPU. 230 ml.
Verre Pliable. TPU. 230 ml.
Opvouwbare Beker. TPU. 230 ml.

Ø 7 x 11 cm 1000 / 50
Print Code: E(1)

New

230 ml

19



500 ml

**Copil 6769**

Antibacterial Bottle. PE. 500 ml.
Antibakteriell Trinkflasche. PE. 500 ml.
Bidon Antibacterienne. PE. 500 ml.
Antibacterieel Fles. PE. 500 ml.

Ø 6.5 x 19.5 cm 100 / 10 Print Code: F(1)



500 ml

03

02

05

19

07

11

01

Iskan 3837

Bottle. PE. 500 ml.
Trinkflasche. PE. 500 ml.
Bidon. PE. 500 ml.
Fles. PE. 500 ml.

Ø 6.5 x 19.5 cm 100 / 10 Print Code: F(1)



04



03

02

05

04

07

11

01

Dumont 20449

Bottle. PE. 840 ml.
Trinkflasche. PE. 840 ml.
Bidon. PE. 840 ml.
Fles. PE. 840 ml.

Ø 7.5 x 25 cm 50 Print Code: F(1)

840 ml

19



650 ml



19

Vandix 5695

Bottle. Tritan. 650 ml.
Trinkflasche. Tritan. 650 ml.
Bidon. Tritan. 650 ml.
Fles. Tritan. 650 ml.

☞ 7 × 23 cm ☞ 50 ☞ Print Code: F(1)

400 ml



19

Boxter 3584

Bottle. PET. 400 ml.
Trinkflasche. PET. 400 ml.
Bidon. PET. 400 ml.
Fles. PET. 400 ml.

☞ 11.5 × 26.5 × 3 cm ☞ 400 / 50 ☞ Print Code: E(1)



11

05



01

19



07

03

600 ml



21

Zanip 4596

Bottle. PS. 600 ml.
Trinkflasche. PS. 600 ml.
Bidon. PS. 600 ml.
Fles. PS. 600 ml.

☞ 7.2 × 22.5 cm ☞ 100 / 20 ☞ Print Code: F(1)



19

06

01



SUBLIMATION

800 ml



Cloister 1410

Set. Bottle Aluminium 800 ml. Absorbent Towel Microfibre 160 g/ m².
Set. Trinkflasche Aluminium 800 ml. Saugfähiges Handtuch Mikrofaser 160 g/ m².
Set. Bidon Aluminium 800 ml. Serviette Absorbante Microfibre 160 g/ m².
Set. Fles Aluminium 800 ml. Absorberende Handdoek Microfiber 160 g/ m².

90 × 40 cm

☞ 27.5 × 8.7 × 16 cm ☞ 20 ☞ Print Code: G(1), L2, L3, N(8), O, P, WR

03

New

380 ml



Pertal 20735

Juicer Bottle. PP. 380 mL. Battery 800 mAh.
 Trinkflasche Fruchtsaftpresse. PP. 380 mL. Batterie 800 mAh.
 Bidon Mixeur Blender. PP. 380 mL. Batterie 800 mAh.
 Fles Sinaasappelpers. PP. 380 mL. Batterij 800 mAh.

📏 Ø 7.8 x 21 cm 📦 30 🖨️ Print Code: F(1)

New



03

New

600 ml



02

Fluxi 20736

Vaporizer Bottle. 600 mL.
 Trinkflasche Zerstäuber. 600 mL.
 Bidon Vaporisateur. 600 mL.
 Fles Sproeier. 600 mL.

📏 Ø 8.2 x 25.2 cm 📦 30 🖨️ Print Code: F(1)



350 ml



Zexen 20737

Fan Bottle. Tritan. 350 mL. 3 Modes. Battery 1.200 mAh.
 Trinkflasche Ventilator. Tritan. 350 mL. 3 Positionen. Batterie 1.200 mAh.
 Bidon Ventilateur. Tritan. 350 mL. 3 Modes. Batterie 1.200 mAh.
 Fles Ventilator. Tritan. 350 mL. 3 Posities. Batterij 1.200 mAh.

📏 Ø 8.5 x 16 cm 📦 50 🖨️ Print Code: F(1)



750 ml

Preuk 1258



400 ml

Greims 5341



800 ml

Bredix 1257



Preuk 1258

Sublimation Bottle. Stainless Steel/ Bamboo. 750 ml.
 Sublimations Trinkflasche. Rostfreier Stahl/ Bambus. 750 ml.
 Bidon Sublimation. Acier Inox/ Bambou. 750 ml.
 Sublimatie Fles. Roestvrij Staal/ Bamboe. 750 ml.

 Ø 7.3 x 22.5 cm  30  Print Code: L2, L3, Q

Greims 5341

Sublimation Bottle. Aluminium. 400 ml.
 Sublimations Trinkflasche. Aluminium. 400 ml.
 Bidon Sublimation. Aluminium. 400 ml.
 Sublimatie Fles. Aluminium. 400 ml.

 Ø 6.6 x 17.5 cm  100 / 20
 Print Code: L2, L3, Q

Bredix 1257

Sublimation Bottle. Aluminium. 800 ml.
 Sublimations Trinkflasche. Aluminium. 800 ml.
 Bidon Sublimation. Aluminium. 800 ml.
 Sublimatie Fles. Aluminium. 800 ml.

 Ø 7.3 x 25.3 cm  50  Print Code: L2, L3, Q

Double Wall



New

500 ml



Jano 20738



500 ml



Cleikon 6165



330 ml



Alirox 6409



Jano 20738

Sublimation Insulated Bottle. Stainless Steel/ Bamboo. 500 ml.
 Sublimations Wärme Flasche. Rostfreier Stahl/ Bambus. 500 ml.
 Bidon Thermique Sublimation. Acier Inox/ Bambou. 500 ml.
 Sublimatie Thermoskan-Fles. Roestvrij Staal/ Bamboe. 500 ml.

 Ø 7.3 x 26 cm  30  Print Code: L2, Q



Cleikon 6165

Sublimation Vacuum Flask. Stainless Steel. 500 ml.
 Sublimations Thermoskanne. Rostfreier Stahl. 500 ml.
 Thermo Sublimation. Acier Inox. 500 ml.
 Sublimatie Thermosfles. Roestvrij Staal. 500 ml.

 Ø 7 x 24.6 cm  30  Print Code: L2, L3, Q

Alirox 6409

Sublimation Vacuum Flask. Stainless Steel. 330 ml.
 Sublimations Thermoskanne. Rostfreier Stahl. 330 ml.
 Thermo Sublimation. Acier Inox. 330 ml.
 Sublimatie Thermosfles. Roestvrij Staal. 330 ml.

 Ø 5.7 x 23 cm  30  Print Code: L2, L3, Q

Pooch 1775



Sublimation Bottle. Stainless Steel/ Cork. 750 ml.
Sublimations Trinkflasche. Rostfreier Stahl/ Kork. 750 ml.
Bidon Sublimation. Acier Inox/ Liège. 750 ml.
Sublimatie Fles. Roestvrij Staal/ Kurk. 750 ml.

Ø 7 x 27.5 cm 50 Print Code: L2, L3, Q



750 ml

Pooch 1775



750 ml

Crafor 1259



700 ml

Bayron 6164

Crafor 1259



Sublimation Bottle. Stainless Steel. 750 ml.
Sublimations Trinkflasche. Rostfreier Stahl. 750 ml.
Bidon Sublimation. Acier Inox. 750 ml.
Sublimatie Fles. Roestvrij Staal. 750 ml.

Ø 7 x 26 cm 30 Print Code: L2, L3, Q

Bayron 6164

Sublimation Bottle. Stainless Steel. 700 ml.
Sublimations Trinkflasche. Rostfreier Stahl. 700 ml.
Bidon Sublimation. Acier Inox. 700 ml.
Sublimatie Fles. Roestvrij Staal. 700 ml.

Ø 7 x 25.7 cm 50 Print Code: L2, L3, Q

Hodis 6480



Sublimation Insulated Bottle. Stainless Steel. 500 ml.
Sublimations Wärme Flasche. Rostfreier Stahl. 500 ml.
Bidon Thermique Sublimation. Acier Inox. 500 ml.
Sublimatie Thermoskan-Fles. Roestvrij Staal. 500 ml.

Ø 7.3 x 22.7 cm 30 Print Code: L2, L3, Q

Double Wall



500 ml

Hodis 6480



500 ml

Ying 1382



500 ml

Varn 1662

Ying 1382



Sublimation Insulated Bottle. Stainless Steel/ Bamboo. 500 ml.
Sublimations Wärme Flasche. Rostfreier Stahl/ Bambus. 500 ml.
Bidon Thermique Sublimation. Acier Inox/ Bambou. 500 ml.
Sublimatie Thermoskan-Fles. Roestvrij Staal/ Bamboe. 500 ml.

Ø 7.1 x 22.7 cm 30 Print Code: L2, L3, Q

Varn 1662



Sublimation Insulated Bottle. Stainless Steel. 500 ml.
Sublimations Wärme Flasche. Rostfreier Stahl. 500 ml.
Bidon Thermique Sublimation. Acier Inox. 500 ml.
Sublimatie Thermoskan-Fles. Roestvrij Staal. 500 ml.

Ø 7.3 x 26.3 cm 30 Print Code: L2, L3, Q

Special Sublimation

DRINKWARE



22

05

07

16

New



500 ml

Vantex 20515

Sublimation Bottle. Glas/ Bamboe. 500 ml.
Sublimations Trinkflasche. Glas/ Bambus. 500 ml.
Bidon Sublimation. Verre/ Bamboe. 500 ml.
Sublimatie Fles. Glas/ Bamboe. 500 ml.



Ø 6.3 × 22.5 cm 50 Print Code: L1, L2, Q



500 ml

Kaory 1774



Sublimation Bottle. Glas/ Bamboe. 500 ml.
Sublimations Trinkflasche. Glas/ Bambus. 500 ml.
Bidon Sublimation. Verre/ Bamboe. 500 ml.
Sublimatie Fles. Glas/ Bamboe. 500 ml.

Ø 6.3 × 22.5 cm 50
Print Code: F(1), L1, L2, Q, WR



21

Dokath 5513



Bottle. Glas/ Stainless Steel. 420 ml. Soft Shell Pouch.
Trinkflasche. Glas/ Rostfreier Stahl. 420 ml. Soft Shell Etui.
Bidon. Verre/ Acier Inox. 420 ml. Etui Soft Shell.
Fles. Glas/ Roestvrij Staal. 420 ml. Soft Shell Zakje.

Ø 6.4 × 19 cm 50 Print Code: G(1), L2, N(8), R

420 ml

Dokath 5513



530 ml

Lurok 6582



Flaber 6870

600 ml

Flaber 6870



Bottle. Glas. 600 ml. Soft Shell Pouch.
Trinkflasche. Glas. 600 ml. Soft Shell Etui.
Bidon. Verre. 600 ml. Etui Soft Shell.
Fles. Glas. 600 ml. Soft Shell Zakje.

Ø 8.5 × 16 cm 40 Print Code: G(1), L2, N(8), R

Lurok 6582



Bottle. Glas/ Bamboe. 530 ml. Soft Shell Pouch.
Trinkflasche. Glas/ Bambus. 530 ml. Soft Shell Etui.
Bidon. Verre/ Bamboe. 530 ml. Etui Soft Shell.
Fles. Glas/ Bamboe. 530 ml. Soft Shell Zakje.

Ø 6.3 × 22.5 cm 30 Print Code: G(1), L2, N(8), R



19

21



01

02

04

370 ml

Katsur 20724

Bottle. RPET. 370 ml.
Trinkflasche. RPET. 370 ml.
Bidon. RPET. 370 ml.
Fles. RPET. 370 ml.

☞ Ø 6.5 x 16.1 cm ☞ 50 ☞ Print Code: F(1)



03



01



04

03

07

350 ml

Dokmo 20389

Bottle. RPET/ Stainless Steel. 350 ml.
Trinkflasche. RPET/ Rostfreier Stahl. 350 ml.
Bidon. RPET/ Acier Inox. 350 ml.
Fles. RPET/ Roestvrij Staal. 350 ml.

☞ Ø 6.5 x 16.3 cm ☞ 50 ☞ Print Code: F(1), L1



19



05

03

440 ml

Deldye 5560

Bottle. Tritan. 440 ml.
Trinkflasche. Tritan. 440 ml.
Bidon. Tritan. 440 ml.
Fles. Tritan. 440 ml.

☞ Ø 7 x 16 cm ☞ 50 ☞ Print Code: F(1)



19



19



01

03

09

350 ml



Barns 20710



Insulated Bottle. Stainless Steel/ Wood. 350 ml.
Wärme Flasche. Rostfreier Stahl/ Holz. 350 ml.
Bidon Thermique. Acier Inox/ Bois. 350 ml.
Thermoskan-Fles. Roestvrij Staal/ Hout. 350 ml.

☞ Ø 6.6 x 17.5 cm ☞ 50
☞ Print Code: F(1), L2, L3, WR



02

Fully customized bottles



Choose the capacity, accessories, colors, designs and packaging for your water bottles.



Customized
mug

360° designs
in full color



Bespoke mugs:
Create a color combination,
add your logo and choose
packaging



07 MUGS & CUPS









RECYCLED STAINLESS STEEL



Dione 20783



Insulated Cup. Recycled Stainless Steel/ PP. 600 ml.
Wärme Trinkbecher. Recycling Rostfreier Stahl/ PP. 600 ml.
Verre Thermique. Acier Inox Recyclé/ PP. 600 ml.
Beker-Fles. Gerecycled Roestvrij Staal/ PP. 600 ml.

 Ø 8.7 × 17.8 cm  50  Print Code: F(1), L1, WR



Suprax 20784



Insulated Mug. Recycled Stainless Steel/ PP. 400 ml.
Wärme Tasse. Recycling Rostfreier Stahl/ PP. 400 ml.
Tasse Thermique. Acier Inox Recyclé/ PP. 400 ml.
Thermoskan-Mok. Gerecycled Roestvrij Staal/ PP. 400 ml.

 Ø 8.8 × 12 cm  50  Print Code: F(1), L1



New



New



400 ml



600 ml

New



300 ml



Korpla 20706

Mug. Recycled Stainless Steel/ PP. 300 ml.
Tasse. Recycling Rostfreier Stahl/ PP. 300 ml.
Tasse. Acier Inox Recyclé/ PP. 300 ml.
Mok. Gerecycled Roestvrij Staal/ PP. 300 ml.

 Ø 7.6 × 8.8 cm  50  Print Code: F(1), L1



02

09

01

New



400 ml



Garfun 20703

Mug. Recycled Stainless Steel/ Wood. 400 ml.
Tasse. Recycling Rostfreier Stahl/ Holz. 400 ml.
Tasse. Acier Inox Recyclé/ Bois. 400 ml.
Mok. Gerecycled Roestvrij Staal/ Hout. 400 ml.

 Ø 8.7 × 8.2 cm  40  Print Code: F(1), L1



09

06

RECYCLED STAINLESS STEEL

327

MUGS & CUPS

New

New



New

01

01



330 ml



06

08

02



06

08

02

Claire 20257



Insulated Mug, Recycled Stainless Steel/ Bamboo. 330 ml.
Wärme Tasse, Recycling Rostfreier Stahl/ Bambus. 330 ml.
Tasse Thermique, Acier Inox Recyclé/ Bambou. 330 ml.
Thermoskan-Mok, Gerecycled Roestvrij Staal/ Bamboe. 330 ml.

☞ Ø 8.8 x 9.4 cm ☞ 36 ☞ Print Code: F(1), L2

Paster 20705



Insulated Mug, Recycled Stainless Steel. 600 ml.
Wärme Tasse, Recycling Rostfreier Stahl. 600 ml.
Tasse Thermique, Acier Inox Recyclé. 600 ml.
Thermoskan-Mok, Gerecycled Roestvrij Staal. 600 ml.

☞ Ø 8.8 x 18 cm ☞ 25 ☞ Print Code: F(1), L1

Tobey 20704



Insulated Mug, Recycled Stainless Steel. 600 ml.
Wärme Tasse, Recycling Rostfreier Stahl. 600 ml.
Tasse Thermique, Acier Inox Recyclé. 600 ml.
Thermoskan-Mok, Gerecycled Roestvrij Staal. 600 ml.

☞ Ø 8.8 x 17.5 cm ☞ 25 ☞ Print Code: F(1), L1

**Frilan 20707**

Insulated Mug. Recycled Stainless Steel/ Cork. 450 ml.
 Wärme Tasse. Recycling Rostfreier Stahl/ Kork. 450 ml.
 Tasse Thermique. Acier Inox Recyclé/ Liège. 450 ml.
 Thermoskan-Mok. Gerecycled Roestvrij Staal/ Kurk. 450 ml.

Ø 7.9 × 17.6 cm 30 Print Code: F(1), L1



350 ml

Sarski 21026

New



450 ml

Frilan 20707

Sarski 21026

Insulated Cup. Recycled Stainless Steel/ Cork. 350 ml.
 Wärme Trinkbecher. Recycling Rostfreier Stahl/ Kork. 350 ml.
 Verre Thermique. Acier Inox Recyclé/ Liège. 350 ml.
 Beker-Fles. Gerecycled Roestvrij Staal/ Kurk. 350 ml.

Ø 8.7 × 13.2 cm 25 Print Code: F(1), L1, WR



New

800 ml

**Atinger 21029**

Insulated Cup. Recycled Stainless Steel. 800 ml.
 Wärme Trinkbecher. Recycling Rostfreier Stahl. 800 ml.
 Verre Thermique. Acier Inox Recyclé. 800 ml.
 Beker-Fles. Gerecycled Roestvrij Staal. 800 ml.

Ø 10 × 20 cm 25 Print Code: F(1), L1



New

340 ml

**Yarton 21028**

Insulated Cup. Recycled Stainless Steel. 340 ml.
 Wärme Trinkbecher. Recycling Rostfreier Stahl. 340 ml.
 Verre Thermique. Acier Inox Recyclé. 340 ml.
 Beker-Fles. Gerecycled Roestvrij Staal. 340 ml.

Ø 8.7 × 11.8 cm 50 Print Code: F(1), L1



New

370 ml

**Doverly 21030**

Insulated Mug. Recycled Stainless Steel. 370 ml.
 Wärme Tasse. Recycling Rostfreier Stahl. 370 ml.
 Tasse Thermique. Acier Inox Recyclé. 370 ml.
 Thermoskan-Mok. Gerecycled Roestvrij Staal. 370 ml.

Ø 8.8 × 12.1 cm 25 Print Code: F(1), L1



COOPER VACUUM INSULATED

420 ml



02

Hanna 1046



Insulated Mug. Stainless Steel. 420 ml. Copper Vacuum Insulated.
Wärme Tasse. Rostfreier Stahl. 420 ml. Kupfer Vakuumisoliert.
Tasse Thermique. Acier Inox. 420 ml. Isolation sous Vide en Cuivre.
Thermoskan-Mok. Roestvrij Staal. 420 ml. Koperen Vacuum Geïsoleerd.

Ø 8.5 x 10.1 cm 40 Print Code: F(1), L1



06



01

350 ml



23

Blur 6860



Insulated Cup. Stainless Steel. 350 ml. Copper Vacuum Insulated.
Wärme Trinkbecher. Rostfreier Stahl. 350 ml. Kupfer Vakuumisoliert.
Verre Thermique. Acier Inox. 350 ml. Isolation sous Vide en Cuivre.
Beker-Fles. Roestvrij Staal. 350 ml. Koperen Vacuum Geïsoleerd.

Ø 8.5 x 12.4 cm 30 Print Code: F(1), L1, WR



02



09



01

ANTONIO MIRO



Antonio Miró is currently a benchmark in the increasingly demanding fashion industry. Worldwide renowned and consolidated in showcases such as Paris, Milan, New York and Tokyo, with prestige earned by collections based on simplicity and perfection, being these his personal hallmarks. Minimalist like few others, Antonio Miró devotes his success to elegance, an objective he has never renounced.

ANTONIO MIRO

450 ml



Reley 7376



Insulated Cup. Stainless Steel. 450 ml.
Wärme Trinkbecher. Rostfreier Stahl. 450 ml.
Verre Thermique. Acier Inox. 450 ml.
Beker-Fles. Roestvrij Staal. 450 ml.

Ø 7.7 x 22.2 cm 25 Print Code: F(1), L1

New

400 ml



03

Drury 20701

Insulated Cup, Stainless Steel. 400 ml.
 Wärme Trinkbecher. Rostfreier Stahl. 400 ml.
 Verre Thermique. Acier Inox. 400 ml.
 Beker-Fles. Roestvrij Staal. 400 ml.

Ø 8.9 × 15.6 cm 30
 Print Code: F(1)



350 ml



08

Vicuit 1796

Insulated Cup, Stainless Steel. 350 ml.
 Wärme Trinkbecher. Rostfreier Stahl. 350 ml.
 Verre Thermique. Acier Inox. 350 ml.
 Beker-Fles. Roestvrij Staal. 350 ml.

Ø 9 × 14.4 cm 40
 Print Code: F(1), L1, WR



New

380 ml



06

Jorlens 21172

Insulated Cup, Stainless Steel. 380 ml.
 Wärme Trinkbecher. Rostfreier Stahl. 380 ml.
 Verre Thermique. Acier Inox. 380 ml.
 Beker-Fles. Roestvrij Staal. 380 ml.

Ø 7.8 × 17.4 cm 50
 Print Code: F(1), L1



350 ml



Bobby 1047

Insulated Cup, Stainless Steel. 350 ml.
 Wärme Trinkbecher. Rostfreier Stahl. 350 ml.
 Verre Thermique. Acier Inox. 350 ml.
 Beker-Fles. Roestvrij Staal. 350 ml.

Ø 8.9 × 12 cm 50
 Print Code: F(1), L1



02

350 ml



02

Harbin 1797

Insulated Cup, Stainless Steel/ PP. 350 ml.
 Wärme Trinkbecher. Rostfreier Stahl/ PP. 350 ml.
 Verre Thermique. Acier Inox/ PP. 350 ml.
 Beker-Fles. Roestvrij Staal/ PP. 350 ml.

Ø 8.9 × 12.5 cm 50
 Print Code: F(1)



01



450 ml



03



02

16



19

11

07

Fresno 5100



Insulated Cup. Stainless Steel. 450 ml.
Wärme Trinkbecher. Rostfreier Stahl. 450 ml.
Verre Thermique. Acier Inox. 450 ml.
Beker-Fles. Roestvrij Staal. 450 ml.

Ø 8.6 × 18 cm 50 Print Code: F(1), L1, WR



350 ml



02



19

01

03

04

Ripon 6283



Insulated Cup. Stainless Steel. 350 ml.
Wärme Trinkbecher. Rostfreier Stahl. 350 ml.
Verre Thermique. Acier Inox. 350 ml.
Beker-Fles. Roestvrij Staal. 350 ml.

Ø 8.3 × 12 cm 50 Print Code: F(1), L1, WR



310 ml



09



04

23

01

02

03

19

Dritox 5806



Insulated Cup. Stainless Steel. 310 ml.
Wärme Trinkbecher. Rostfreier Stahl. 310 ml.
Verre Thermique. Acier Inox. 310 ml.
Beker-Fles. Roestvrij Staal. 310 ml.

Ø 7.2 × 16.7 cm 50 Print Code: F(1), L1, WR

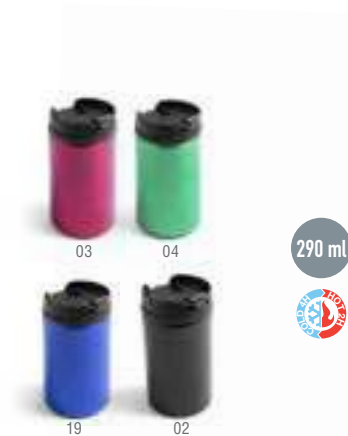

290 ml



03

04

19

02

Citrox 4880



Insulated Cup. Stainless Steel. 290 ml.
Wärme Trinkbecher. Rostfreier Stahl. 290 ml.
Verre Thermique. Acier Inox. 290 ml.
Beker-Fles. Roestvrij Staal. 290 ml.

Ø 7.3 × 14.4 cm 50 Print Code: F(1), L1, L3, WR



Special size for
espresso machines.
Ideal for office and take
away



160 ml



Zirgul 1050



Insulated Cup. Stainless Steel. 160 ml.
Wärme Trinkbecher. Rostfreier Stahl. 160 ml.
Verre Thermique. Acier Inox. 160 ml.
Beker-Fles. Roestvrij Staal. 160 ml.

Ø 7.2 × 10 cm 50 Print Code: F(1), L1, WR



09



01

02

09

STAINLESS STEEL & CORK

MUGS & CUPS

380 ml



330 ml



650 ml



01

09

02

Nerux 6298



DOUBLE WALL

Insulated Cup, Stainless Steel/ Cork, 380 ml.
Wärme Trinkbecher, Rostfreier Stahl/ Kork, 380 ml.
Verre Thermique, Acier Inox/ Liège, 380 ml.
Beker-Fles, Roestvrij Staal/ Kurk, 380 ml.

☞ Ø 8.7 x 13.4 cm ☞ 30 ☞ Print Code: F(1), L1, WR



Barker 1777



DOUBLE WALL



SUBLIMATION

Sublimation Insulated Cup, Stainless Steel/ Cork, 330 ml.
Sublimations Wärme Trinkbecher, Rostfreier Stahl/ Kork, 330 ml.
Verre Thermique Sublimation, Acier Inox/ Liège, 330 ml.
Sublimatie Beker-Fles, Roestvrij Staal/ Kurk, 330 ml.

☞ Ø 8.6 x 12.4 cm ☞ 50 ☞ Print Code: L1, Q



Kallum 1791



DOUBLE WALL



SUBLIMATION

Sublimation Insulated Cup, Stainless Steel, 650 ml.
Sublimations Wärme Trinkbecher, Rostfreier Stahl, 650 ml.
Verre Thermique Sublimation, Acier Inox, 650 ml.
Sublimatie Beker-Fles, Roestvrij Staal, 650 ml.

☞ Ø 7.8 x 18.7 cm ☞ 50 ☞ Print Code: L3, Q



New

540 ml



New

480 ml

333

MUGS & CUPS



280 ml



STAINLESS STEEL & BAMBOO



09

03

02

19



09

03

02

19



Arlene 20210

Cup, Aluminium. 540 ml.
Weinglas, Aluminium. 540 ml.
Verre à Vin, Aluminium. 540 ml.
Wijn glas, Aluminium. 540 ml.

📏 Ø 9.2 × 21.4 cm 📦 50 🖨️ Print Code: F(1), L1

Amely 20212

Cup, Aluminium. 480 ml.
Trinkbecher, Aluminium. 480 ml.
Verre, Aluminium. 480 ml.
Beker, Aluminium. 480 ml.

📏 Ø 8.5 × 10 cm 📦 50 🖨️ Print Code: F(1), L1

Zasel 1068



Insulated Cup, Stainless Steel/ Bamboo. 280 ml.
Wärme Trinkbecher, Rostfreier Stahl/ Bambus. 280 ml.
Verre Thermique, Acier Inox/ Bambou. 280 ml.
Beker-Fles, Roestvrij Staal/ Bamboe. 280 ml.

📏 Ø 7.8 × 9.5 cm 📦 50 🖨️ Print Code: F(1), L1

ELECTROPLATING
COOPER COATING

Recubrimiento de cobre galvanizado

New

270 ml

400 ml



Riberton 1459

Cup. Stainless Steel. 400 ml.
Trinkbecher. Rostfreier Stahl. 400 ml.
Verre. Acier Inox. 400 ml.
Beker. Roestvrij Staal. 400 ml.

Ø 8.4 x 10.8 cm 50
Print Code: F(1), L1



Duglas 1762



Insulated Cup. Stainless Steel. 350 ml.
Wärme Trinkbecher. Rostfreier Stahl. 350 ml.
Verre Thermique. Acier Inox. 350 ml.
Beker-Fles. Roestvrij Staal. 350 ml.

Ø 8.9 x 12 cm 50 Print Code: F(1), L1

350 ml



Gagax 20129

Flute Glass Set. Stainless Steel. 2 Pieces. 270 ml.
Glas Set. Rostfreier Stahl. 2 Stück. 270 ml.
Set Verres. Acier Inox. 2 Pièces. 270 ml.
Glas Set. Roestvrij Staal. 2 Stuks. 270 ml.

13.5 x 25.5 x 7 cm 80 Print Code: F(1), L1



ELECTROPLATING COOPER COATING

Recubrimiento de cobre galvanizado

335

MUGS & CUPS



280 ml

Belon 20153



Mug. Stainless Steel. 280 ml.
Tasse. Rostfreier Stahl. 280 ml.
Tasse. Acier Inox. 280 ml.
Mok. Roestvrij Staal. 280 ml.



📏 Ø 7.6 x 8.9 cm 📦 50 🖨️ Print Code: F(1), L1



500 ml

Keynes 1458



Mug. Stainless Steel. 500 ml.
Tasse. Rostfreier Stahl. 500 ml.
Tasse. Acier Inox. 500 ml.
Mok. Roestvrij Staal. 500 ml.

📏 Ø 9.3 x 10 cm 📦 50 🖨️ Print Code: F(1), L1



500 ml

Indya 20152



Mug. Stainless Steel. 500 ml.
Tasse. Rostfreier Stahl. 500 ml.
Tasse. Acier Inox. 500 ml.
Mok. Roestvrij Staal. 500 ml.

📏 Ø 9.3 x 10 cm 📦 50 🖨️ Print Code: F(1), L1

STAINLESS STEEL
&
BAMBOO

300 ml



500 ml



300 ml

**Lubon 6875**

Insulated Cup, Bamboo/ Stainless Steel, 300 ml.
Wärme Trinkbecher, Bambus/ Rostfreier Stahl, 300 ml.
Verre Thermique, Bambou/ Acier Inox, 300 ml.
Beker-Fles, Bamboe/ Roestvrij Staal, 300 ml.

☞ Ø 8 x 10.5 cm ☞ 50 ☞ Print Code: F(1), L2

**Ariston 6170**

Insulated Cup, Bamboo/ Stainless Steel, 500 ml.
Wärme Trinkbecher, Bambus/ Rostfreier Stahl, 500 ml.
Verre Thermique, Bambou/ Acier Inox, 500 ml.
Beker-Fles, Bamboe/ Roestvrij Staal, 500 ml.

☞ Ø 8.2 x 17.5 cm ☞ 50 ☞ Print Code: F(1), L2

**Vanatin 6876**

Insulated Mug, Bamboo/ Stainless Steel, 300 ml.
Wärme Tasse, Bambus/ Rostfreier Stahl, 300 ml.
Tasse Thermique, Bambou/ Acier Inox, 300 ml.
Thermoskan-Mok, Bamboe/ Roestvrij Staal, 300 ml.

☞ Ø 8 x 10.5 cm ☞ 50 ☞ Print Code: F(1), L2



**FOOD
GRADE**

quality certified

Products of food grade
quality certified.

NATURAL CORK

337

500 ml



Borio 2715



350 ml



Rugrat 2716



Borio 2715



Insulated Cup, Cork/ PP, 500 ml.
Wärme Trinkbecher, Kork/ PP, 500 ml.
Verre Thermique, Liège/ PP, 500 ml.
Beker-Fles, Kurk/ PP, 500 ml.

Made in Europe

Ø 8.3 x 15.5 cm 50 Print Code: F(1), L1

MUGS & CUPS



Rugrat 2716



Insulated Cup, Cork/ PP, 350 ml.
Wärme Trinkbecher, Kork/ PP, 350 ml.
Verre Thermique, Liège/ PP, 350 ml.
Beker-Fles, Kurk/ PP, 350 ml.

Made in Europe

Ø 8.3 x 12.2 cm 50 Print Code: F(1), L1



350 ml

Tarkol 6918

Cup, Borosilicate Glass/ Cork, 350 ml.
Trinkbecher, Borosilikat Glas/ Kork, 350 ml.
Verre, Verre Borosilicate/ Liège, 350 ml.
Beker, Borosilicate Glas/ Kurk, 350 ml.

Ø 9 x 12.8 cm 30 Print Code: F(1), L1



350 ml



Plibun 6562



Insulated Cup, Cork/ PP, 350 ml.
Wärme Trinkbecher, Kork/ PP, 350 ml.
Verre Thermique, Liège/ PP, 350 ml.
Beker-Fles, Kurk/ PP, 350 ml.

Ø 9.2 x 14.5 cm 30 Print Code: F(1), L1





Products of food grade
quality certified.



New

made of recycled PP

300 ml



450 ml



450 ml

Double Wall

Holwe 20196



02

08

01

Insulated Cup, Recycled PP, 300 mL.
Warme Trinkbecher, PP Recycling, 300 mL.
Verre Thermique, PP Recyclé, 300 mL.
Beker-Fles, Gerecycled PP, 300 mL.

☞ Ø 8.9 x 12.6 cm ☞ 100 ☞ Print Code: F(1), WR

Koton 6707



Antibacterial Cup, PP, 450 mL.
Antibakteriell Trinkbecher, PP, 450 mL.
Verre Antibacterienne, PP, 450 mL.
Antibacterieel Beker, PP, 450 mL.

☞ Ø 9.3 x 13.4 cm ☞ 50 ☞ Print Code: F(1), WR

Petel 6676



Cup, PLA 100% Compostable, 450 mL.
Trinkbecher, PLA 100% Kompostierbar, 450 mL.
Verre, PLA 100% Compostable, 450 mL.
Beker, PLA 100% Composteerbaar, 450 mL.

☞ Ø 9.3 x 13.4 cm ☞ 50 ☞ Print Code: F(1), WR





Products of food grade quality certified.



300 ml



08

Double Wall

Manyuk 1799

Insulated Cup, PP, 300 ml.
Wärme Trinkbecher, PP, 300 ml.
Verre Thermique, PP, 300 ml.
Beker-Fles, PP, 300 ml.



06



13



02

☞ Ø 9.4 × 12.4 cm ☞ 100 ☞ Print Code: F(1), WR



350 ml

Fredy 1157

Cup, PP/ Bamboo/ Cork, 350 ml.
Trinkbecher, PP/ Bambus/ Kork, 350 ml.
Verre, PP/ Bambou/ Liège, 350 ml.
Beker, PP/ Bamboe/ Kurk, 350 ml.

☞ Ø 8.7 × 10.8 cm ☞ 50 ☞ Print Code: F(1), L2



350 ml

Melpak 1159

Cup, PP/ TPR, 350 ml.
Trinkbecher, PP/ TPR, 350 ml.
Verre, PP/ TPR, 350 ml.
Beker, PP/ TPR, 350 ml.

☞ Ø 9.5 × 11.4 cm ☞ 100 / 10 ☞ Print Code: F(1)

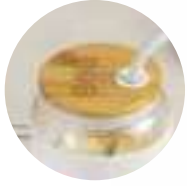

New



1,6 L

Jacin 20204

Jar. Glas/ Bamboe. 1,6 L. Silicone Pouch.
Krug. Glas/ Bambus. 1,6 L. Silikon Etui.
Pot. Verre/ Bamboe. 1,6 L. Étui Silicone.
Pot. Glas/ Bamboe. 1,6 L. Siliconen Zakje.

☰ Ø 12 × 19 cm 📦 15
🔗 Print Code: F(1), L2



New



1,1 L

Namun 20205

Jar. Glas/ Bamboe. 1,1 L. Silicone Pouch.
Krug. Glas/ Bambus. 1,1 L. Silikon Etui.
Pot. Verre/ Bamboe. 1,1 L. Étui Silicone.
Pot. Glas/ Bamboe. 1,1 L. Siliconen Zakje.

☰ Ø 10 × 22,3 cm 📦 15
🔗 Print Code: F(1), L2



500 ml



Tromury 1790

Cup. Borosilicate Glas/ Bamboe. 500 ml. Cork Pouch.
Trinkbecher. Borosilikat Glas/ Bambus. 500 ml. Kork Etui.
Verre. Verre Borosilicate/ Bamboe. 500 ml. Étui Liège Naturel.
Beker. Borosilicate Glas/ Bamboe. 500 ml. Kurk Zakje.

☰ Ø 7 × 22,2 cm 📦 30 🔗 Print Code: F(1), L1



New

450 ml



Zilber 20164

Cup. Borosilicate Glas/ Bamboe. 450 ml. Felt RPET Pouch.
Trinkbecher. Borosilikat Glas/ Bambus. 450 ml. Filz RPET Etui.
Verre. Verre Borosilicate/ Bamboe. 450 ml. Étui Feutrine RPET.
Beker. Borosilicate Glas/ Bamboe. 450 ml. Vilt RPET Zakje.

☰ Ø 6,7 × 20,5 cm 📦 30 🔗 Print Code: G(1), L1, N(8)



500 ml

11

Heisond 5494

Jar. Glass. 500 ml.
Krug. Glas. 500 ml.
Pot. Verre. 500 ml.
Pot. Glas. 500 ml.

7.6 x 13.4 x 7.3 cm 36
Print Code: F(1), L2



New

430 ml

Audrey 20208

Cup. Recycled Aluminium/ Bamboe. 430 ml.
Trinkbecher. Recycling Aluminium/ Bambou. 430 ml.
Verre. Aluminium Recyclé/ Bamboe. 430 ml.
Beker. Gerecycled Aluminium/ Bamboe. 430 ml.

7.3 x 12.8 cm 50 Print Code: F(1), L1



New

400 ml



Fonix 20514

Sublimation Jar. Glass/ Bamboe. 400 ml.
Sublimations Krug. Glas/ Bamboe. 400 ml.
Pot Sublimation. Verre/ Bamboe. 400 ml.
Sublimatie Pot. Glas/ Bamboe. 400 ml.

7.7 x 12.5 cm 30 Print Code: L1, Q



600 ml



Double Wall

Moder 20163

Insulated Cup. Stainless Steel. 600 ml.
Wärme Trinkbecher. Rostfreier Stahl. 600 ml.
Verre Thermique. Acier Inox. 600 ml.
Beker-Flies. Roestvrij Staal. 600 ml.

10 x 17.5 cm 30 Print Code: F(1), L1



750 ml

Trinox 4874

Cup. PS. 750 ml.
Trinkbecher. PS. 750 ml.
Verre. PS. 750 ml.
Beker. PS. 750 ml.

10 x 17.5 cm 20 Print Code: F(1)



FOOD GRADE
quality certified.



Products of food grade
quality certified.

100% COMPOSTABLE
BIODEGRADABLE

PLA

USE ME,
I AM ECO-FRIENDLY



350 ml

Pioka 6677

Mug, PLA 100% Compostable, 350 ml.
Tasse, PLA 100% Komposterbar, 350 ml.
Tasse, PLA 100% Compostable, 350 ml.
Mok, PLA 100% Composteerbaar, 350 ml.

☒ Ø 7.9 x 8.8 cm ☒ 100 / 50 ☒ Print Code: F(4)



350 ml



Plantex 6706

Antibacterial Mug, PP, 350 mL.
Antibakteriell Tasse, PP, 350 ml.
Tasse Antibacterienne, PP, 350 ml.
Antibacterieel Mok, PP, 350 ml.

☒ Ø 7.9 x 8.8 cm ☒ 100 / 50 ☒ Print Code: F(4)



350 ml

Esprit 1160

Mug, PP, 350 mL.
Tasse, PP, 350 ml.
Tasse, PP, 350 ml.
Mok, PP, 350 ml.

☒ Ø 7.9 x 8.8 cm ☒ 100 / 50 ☒ Print Code: F(4)



made of PP
**FOOD
 GRADE**
 quality certified
 Products of food grade
 quality certified.



220 ml

New

02



220 ml



Jado 20197

Foldable Cup. Recycled PP. 220 ml.
 Faltbarer Trinkbecher. PP Recycling. 220 ml.
 Verre Pliable. PP Recyclé. 220 ml.
 Opvouwbare Beker. Gerecycled PP. 220 ml.

☞ Ø 6.8 x 9 cm ☞ 100 / 50 ☞ Print Code: D(4), W



08

01

06

Sainod 1161

Foldable Cup. PP. 220 ml.
 Faltbarer Trinkbecher. PP. 220 ml.
 Verre Pliable. PP. 220 ml.
 Opvouwbare Beker. PP. 220 ml.

☞ Ø 6.8 x 9 cm ☞ 100 / 50 ☞ Print Code: D(4), W



220 ml

Daibak 1730

Foldable Cup. Stainless Steel. 220 ml.
 Faltbarer Trinkbecher. Rostfreier Stahl. 220 ml.
 Verre Pliable. Acier Inox. 220 ml.
 Opvouwbare Beker. Roestvrij Staal. 220 ml.

☞ Ø 7.8 x 8 cm ☞ 100 / 50
 ☞ Print Code: E(1), L1



160 ml

New

Klimt 20702

Foldable Cup. Silicone. 160 ml.
 Faltbarer Trinkbecher. Silikon. 160 ml.
 Verre Pliable. Silicone. 160 ml.
 Opvouwbare Beker. Siliconen. 160 ml.

☞ Ø 7.3 x 8.6 cm ☞ 200 / 100
 ☞ Print Code: F(1)



02

01

19

REUSABLE CUPS

Special Events



Hesun 2760

Cup. PP. 1,2 L.
Trinkbecher. PP. 1,2 L.
Verre. PP. 1,2 L.
Beker. PP. 1,2 L.

Ø 10,7 x 19 cm 400
Print Code: C(1)

12 L



Raxon 2751

Cup. PP. 600 ml.
Trinkbecher. PP. 600 ml.
Verre. PP. 600 ml.
Beker. PP. 600 ml.

Ø 8,8 x 12 cm 450 / 25
Print Code: C(1)

600 ml



Ginbert 2494

Cup. PP. 500 ml.
Trinkbecher. PP. 500 ml.
Verre. PP. 500 ml.
Beker. PP. 500 ml.

Ø 9,2 x 11,6 cm 500 / 25
Print Code: C(1)

500 ml



Colorbert 2752

Cup. PP. 500 ml.
Trinkbecher. PP. 500 ml.
Verre. PP. 500 ml.
Beker. PP. 500 ml.

Ø 8,9 x 11 cm 450 / 25
Print Code: C(1)

500 ml



04

Combi 2753

Cup. PP. 450 ml.
Trinkbecher. PP. 450 ml.
Verre. PP. 450 ml.
Beker. PP. 450 ml.

Ø 8 x 13,3 cm 500 / 25
Print Code: C(1)

450 ml



Cuvak 2754

Cup. PP. 400 ml.
Trinkbecher. PP. 400 ml.
Verre. PP. 400 ml.
Beker. PP. 400 ml.

Ø 8 x 11,5 cm 500 / 25
Print Code: C(1)

400 ml



Tanpil 2759

Cup. PP. 330 ml.
Trinkbecher. PP. 330 ml.
Verre. PP. 330 ml.
Beker. PP. 330 ml.

Ø 7,8 x 7,8 cm 320
Print Code: C(1)

330 ml



Chiquito 2755

Cup. PP. 220 ml.
Trinkbecher. PP. 220 ml.
Verre. PP. 220 ml.
Beker. PP. 220 ml.

Ø 7,9 x 5,5 cm 480
Print Code: C(1)

220 ml



Chupito 2756

Cup. PP. 35 ml.
Trinkbecher. PP. 35 ml.
Verre. PP. 35 ml.
Beker. PP. 35 ml.

Ø 3,9 x 4,6 cm 1000
Print Code: B(1)

35 ml



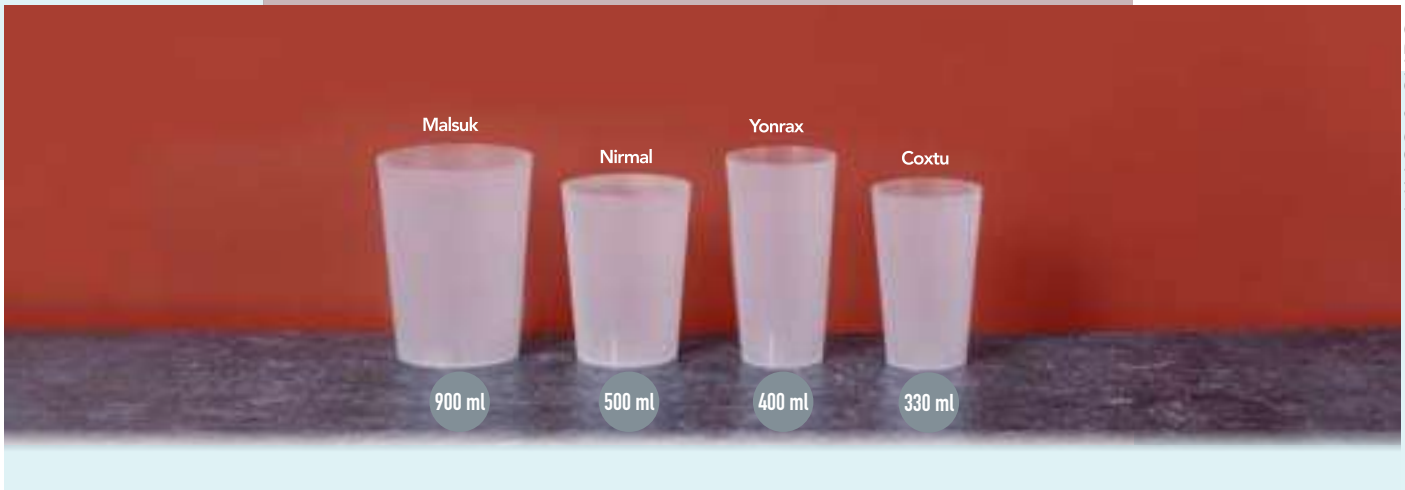

Special Events

Malsuk 2757

Cup, PP, 900 mL.
Trinkbecher, PP, 900 mL.
Verre, PP, 900 mL.
Beker, PP, 900 mL.

☞ Ø 10,5 x 13,6 cm

📦 150

🖨️ Print Code: C(1)

900 ml



Nirmal 2554

Cup, PP, 500 mL.
Trinkbecher, PP, 500 mL.
Verre, PP, 500 mL.
Beker, PP, 500 mL.

☞ Ø 8,7 x 11,8 cm

📦 384 / 16

🖨️ Print Code: C(1)

500 ml



Yonrax 2555

Cup, PP, 400 mL.
Trinkbecher, PP, 400 mL.
Verre, PP, 400 mL.
Beker, PP, 400 mL.

☞ Ø 7,5 x 14 cm

📦 490 / 14

🖨️ Print Code: C(1)

400 ml



Coxtu 2758

Cup, PP, 330 mL.
Trinkbecher, PP, 330 mL.
Verre, PP, 330 mL.
Beker, PP, 330 mL.

☞ Ø 7 x 12 cm

📦 360

🖨️ Print Code: C(1)

330 ml



New 450 ml



Bixlo 20525

Cup. Borosilicate Glass/ Cork. 450 mL.
 Trinkbecher. Borosilikat Glas/ Kork. 450 mL.
 Verre. Verre Borosilicate/ Liège. 450 mL.
 Beker. Borosilicate Glas/ Kurk. 450 mL.

Ø 8.5 x 11 cm 50 Print Code: F(1), L1



350 ml

350 ml



02



16

Durnox 6869

Cup. Glass/ Silicone. 350 mL.
 Trinkbecher. Glas/ Silikon. 350 mL.
 Verre. Verre/ Silicone. 350 mL.
 Beker. Glas/ Siliconen. 350 mL.



01



19



03

Ø 9.5 x 12.4 cm 30 Print Code: F(1)



250 ml



Tobby 1072



Insulated Cup. Borosilicate Glass/ Bamboo. 350 mL.
 Wärme Trinkbecher. Borosilikat Glas/ Bambus. 350 mL.
 Verre Thermique. Verre Borosilicate/ Bambou. 350 mL.
 Beker-Fles. Borosilicate Glas/ Bamboe. 350 mL.

Ø 8.8 x 13.5 cm 40 Print Code: F(1), L2

Nystre 1071



Insulated Cup. Borosilicate Glass/ Bamboo. 250 mL.
 Wärme Trinkbecher. Borosilikat Glas/ Bambus. 250 mL.
 Verre Thermique. Verre Borosilicate/ Bambou. 250 mL.
 Beker-Fles. Borosilicate Glas/ Bamboe. 250 mL.

Ø 8.8 x 10.8 cm 40 Print Code: F(1), L2



19

01

03

02

Saryne 20524

Mug. Borosilicate Glass/ Cork. 450 ml.
Tasse. Borosilikat Glas/ Kork. 450 ml.
Tasse. Verre Borosilicate/ Liège. 450 ml.
Mok. Borosilicate Glas/ Kurk. 450 ml.

📏 Ø 8.5 x 11 cm 📦 50 🖨️ Print Code: F(1), L1

New

450 ml



450 ml

Masty 1073

Tea Mug. Borosilicate Glass/ Bamboo. 450 ml. Infuser Included.
Tee Tasse. Borosilikat Glas/ Bambus. 450 ml. Inklusive Teesieb.
Tasse à Thé. Verre Borosilicate/ Bambou. 450 ml. Infuseur Inclusé.
Thee Mok. Borosilicate Glas/ Bamboe. 450 ml. Thee-Ei Inclusief.

📏 Ø 8 x 12.5 cm 📦 30 🖨️ Print Code: F(1), L2



370 ml

Laik 1702

Insulated Mug. Borosilicate Glass/ Bamboo. 370 ml.
Wärme Tasse. Borosilikat Glas/ Bambus. 370 ml.
Tasse Thermique. Verre Borosilicate/ Bambou. 370 ml.
Thermoskan-Mok. Borosilicate Glas/ Bamboe. 370 ml.

📏 Ø 8.4 x 11.6 cm 📦 30 🖨️ Print Code: F(1), L2



450 ml

Hindras 6865

Mug. Borosilicate Glass/ Cork. 450 ml.
Tasse. Borosilikat Glas/ Kork. 450 ml.
Tasse. Verre Borosilicate/ Liège. 450 ml.
Mok. Borosilicate Glas/ Kurk. 450 ml.

📏 Ø 8 x 11.8 cm 📦 36 🖨️ Print Code: F(1)



420 ml

Kipal 6481

Mug. Borosilicate Glass/ Bamboo. 420 ml.
Tasse. Borosilikat Glas/ Bambou. 420 ml.
Tasse. Verre Borosilicate/ Bambou. 420 ml.
Mok. Borosilicate Glas/ Bamboe. 420 ml.

Ø 8.7 × 10.6 cm 50 Print Code: F(1), C(4), L1, L2



420 ml

Yirax 1216

Mug. Glass/ Bamboo. 420 ml.
Tasse. Glas/ Bambou. 420 ml.
Tasse. Verre/ Bambou. 420 ml.
Mok. Glas/ Bamboe. 420 ml.

13.3 × 10.7 × 13 cm 20 Print Code: F(1), C(4), L1, L2



90 ml

Gladen 1701

DOUBLE WALL

Mugs Set. 2 Mugs Borosilicate Glass 90 ml. 2 Coasters Bamboo.
Tassen Set. 2 Tassen Borosilikat Glas 90 ml. 2 Untersetzer Bambou.
Set Tasses. 2 Tasses Verre Borosilicate 90 ml. 2 Sous-Verre Bambou.
Mokken Set. 2 Mokken Borosilicate Glas 90 ml. 2 Onderzetter Bamboe.

18.8 × 6.5 × 10 cm 25 Print Code: E(1), L2



400 ml

Chantir 2651

♻️ Made in Europe

Mug. Recycled Glass. 400 ml.
Tasse. Recycling Glas. 400 ml.
Tasse. Verre Recyclé. 400 ml.
Mok. Gerecycled Glas. 400 ml.

Ø 8.8 × 10.2 cm 24 Print Code: F(1), L2



100% Recycled GLASS



300 ml

Rawlin 2650

♻️ Made in Europe

Cup. Recycled Glass. 300 ml.
Trinkbecher. Recycling Glas. 300 ml.
Verre. Verre Recyclé. 300 ml.
Beker. Gerecycled Glas. 300 ml.

Ø 8 × 12.5 cm 24 Print Code: F(1), L2





1.35 L

320 ml

Malister 1704

Set. Glass. 4 Cups Glass 320 ml. Jug 1,35 L.
 Set. Glas. 4 Trinkbecher Glas 320 ml. Krug 1,35 L.
 Set. Verre. 4 Verres 320 ml. Carafe 1,35 L.
 Set. Glas. 4 Beker Glas 320 ml. Kan 1,35 L.

📏 26.4 x 28 x 9.7 cm 📦 8 🔄 Print Code: F(1)



Hernan 1070

500 ml

Cup. Glass. 500 ml.
 Trinkbecher. Glas. 500 ml.
 Verre. Verre. 500 ml.
 Beker. Glas. 500 ml.

📏 Ø 6.4 x 11.8 cm 📦 50 🔄 Print Code: F(1), L2



Merzex 1254

320 ml

Cup. Glass. 320 ml.
 Trinkbecher. Glas. 320 ml.
 Verre. Verre. 320 ml.
 Beker. Glas. 320 ml.

📏 Ø 7.3 x 9.6 cm 📦 50 🔄 Print Code: F(1), L2



Brant 6999

350 ml

Mug. Glass. 350 ml. Not suitable for sublimation.
 Tasse. Glas. 350 ml. Nicht geeignet für sublimation.
 Tasse. Verre. 350 ml. Ne convient pas à la sublimation.
 Mok. Glas. 350 ml. Niet geschikt voor sublimatie.

📏 Ø 8 x 9.6 cm 📦 36 🔄 Print Code: F(1)

330 ml



DOUBLE WALL



New



Bokat 20709

Insulated Mug, Stainless Steel. 330 ml.
Wärme Tasse, Rostfreier Stahl. 330 ml.
Tasse Thermique, Acier Inox. 330 ml.
Thermoskan-Mok, Roestvrij Staal. 330 ml.

☰ Ø 9.6 x 12.4 cm ☑ 50 ☎ Print Code: F(1), L1



09

Loret 1771



Insulated Mug, Stainless Steel/ Cork. 330 ml.
Wärme Tasse, Rostfreier Stahl/ Kork. 330 ml.
Tasse Thermique, Acier Inox/ Liège. 330 ml.
Thermoskan-Mok, Roestvrij Staal/ Kurk. 330 ml.

☰ Ø 8.8 x 11.7 cm ☑ 30 ☎ Print Code: F(1), L1



01

02



06

NEW COLOR



01



02

Tikam 1798



Insulated Mug, Stainless Steel/ PP. 350 ml.
Wärme Tasse, Rostfreier Stahl/ PP. 350 ml.
Tasse Thermique, Acier Inox/ PP. 350 ml.
Thermoskan-Mok, Roestvrij Staal/ PP. 350 ml.

☰ Ø 8.7 x 11.7 cm ☑ 30 ☎ Print Code: F(1)



08



06

NEW COLOR



19

03

16

11



07

Carson 5101



Insulated Mug, Stainless Steel. 450 ml.
Wärme Tasse, Rostfreier Stahl. 450 ml.
Tasse Thermique, Acier Inox. 450 ml.
Thermoskan-Mok, Roestvrij Staal. 450 ml.

☰ Ø 8.6 x 18 cm ☑ 50 ☎ Print Code: F(1), L1

450 ml



02

350 ml



Ricaly 1069



Insulated Mug, Stainless Steel/ Bamboo. 350 ml.
Wärme Tasse, Rostfreier Stahl/ Bambus. 350 ml.
Tasse Thermique, Acier Inox/ Bambou. 350 ml.
Thermoskan-Mok, Roestvrij Staal/ Bamboe. 350 ml.

☰ Ø 8.5 x 11.9 cm ☑ 40 ☎ Print Code: F(1), L1, L2



New



540 ml



09 03 02 19

Ashley 20211

Mug, Aluminium, 540 ml.
Tasse, Aluminium, 540 ml.
Tasse, Aluminium, 540 ml.
Mok, Aluminium, 540 ml.

☞ Ø 9.1 x 10.2 cm ☞ 50 ☞ Print Code: F(1), L1

VINTAGE DESIGN
IMPERFECT FINISH



350 ml

08



380 ml

02



380 ml

19



06

01

02



19

03

01

NEW
COLOR



03

05

04

02

01

Shirley 1048



Mug, Stainless Steel, 350 ml.
Tasse, Rostfreier Stahl, 350 ml.
Tasse, Acier Inox, 350 ml.
Mok, Roestvrij Staal, 350 ml.

☞ Ø 8.5 x 8 cm ☞ 50 ☞ Print Code: F(1), L1

Kirpal 6861

Mug, Stainless Steel, 380 ml.
Tasse, Rostfreier Stahl, 380 ml.
Tasse, Acier Inox, 380 ml.
Mok, Roestvrij Staal, 380 ml.

☞ Ø 8.8 x 7.9 cm ☞ 50 ☞ Print Code: F(1), L1



04

05

06

Wilem 5571

Mug, Metal, 380 ml.
Tasse, Metall, 380 ml.
Tasse, Métal, 380 ml.
Mok, Metaal, 380 ml.

☞ Ø 8.8 x 7.9 cm ☞ 50 ☞ Print Code: F(4)

280 ml



19

Yozax 4656

Mug. Stainless Steel. 280 ml.
Tasse. Rostfreier Stahl. 280 ml.
Tasse. Acier Inox. 280 ml.
Mok. Roestvrij Staal. 280 ml.



Ø 7.6 x 8.9 cm 50 Print Code: F(1), L1

New

145 ml



Melbour 20457

Mug. Stainless Steel. 145 ml.
Tasse. Rostfreier Stahl. 145 ml.
Tasse. Acier Inox. 145 ml.
Mok. Roestvrij Staal. 145 ml.



Ø 7 x 7.2 cm 50 Print Code: F(1), L1

New

300 ml



03

Lecrer 20456

Mug. Recycled Stainless Steel. 300 ml.
Tasse. Recycling Rostfreier Stahl. 300 ml.
Tasse. Acier Inox Recyclé. 300 ml.
Mok. Gerecycled Roestvrij Staal. 300 ml.



Ø 7.6 x 9 cm 50 Print Code: F(1), L1

210 ml



19

Bastic 4509

Mug. Stainless Steel. 210 ml.
Tasse. Rostfreier Stahl. 210 ml.
Tasse. Acier Inox. 210 ml.
Mok. Roestvrij Staal. 210 ml.



Ø 7 x 8 cm 50 Print Code: F(1), L1

SPECIAL Sublimation

353

MUGS & CUPS

Kantol 6359



Sublimation Mug, Metal, 380 ml.
Sublimations Tasse, Metall, 380 ml.
Tasse Sublimation, Métal, 380 ml.
Sublimatie Mok, Metaal, 380 ml.

☞ Ø 8.8 x 7.9 cm ☞ 50 ☞ Print Code: L1, Q

Neyms 6111



Sublimation Mug, Metal, 380 ml.
Sublimations Tasse, Metall, 380 ml.
Tasse Sublimation, Métal, 380 ml.
Sublimatie Mok, Metaal, 380 ml.

☞ Ø 8.8 x 7.9 cm ☞ 50 ☞ Print Code: Q



650 ml



Kallum 1791



Sublimation Insulated Cup, Stainless Steel, 650 ml.
Sublimations Wärme Trinkbecher, Rostfreier Stahl, 650 ml.
Verre Thermique Sublimation, Acier Inox, 650 ml.
Sublimatie Beker-Fles, Roestvrij Staal, 650 ml.

☞ Ø 7.8 x 18.7 cm ☞ 50 ☞ Print Code: L3, Q

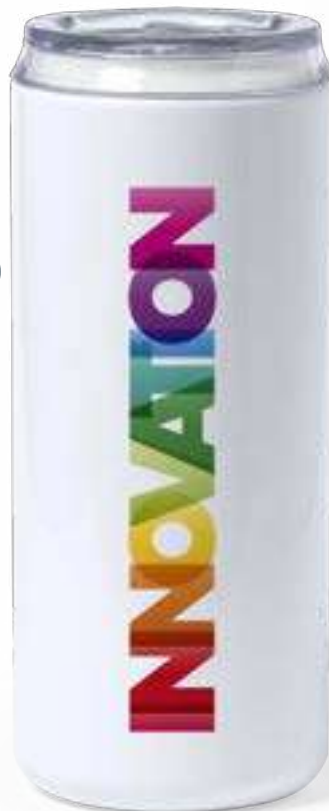

330 ml



Wifly 1776



Sublimation Insulated Mug, Stainless Steel/ Cork, 330 ml.
Sublimations Wärme Tasse, Rostfreier Stahl/ Kork, 330 ml.
Tasse Thermique Sublimation, Acier Inox/ Liège, 330 ml.
Sublimatie Thermoskan-Mok, Roestvrij Staal/ Kurk, 330 ml.

☞ Ø 8.8 x 11.7 cm ☞ 30 ☞ Print Code: L1, Q





19



20



02



Lanteira 21092

Sublimation Mug, Ceramic, 350 ml.
Sublimations Tasse, Keramik, 350 ml.
Tasse Sublimation, Céramique, 350 ml.
Sublimatie Mok, Keramiek, 350 ml.

Ø 8 x 9.8 cm 36
Print Code: Q



04

05

Orchix 20509

Sublimation Mug, Ceramic, 350 ml.
Sublimations Tasse, Keramik, 350 ml.
Tasse Sublimation, Céramique, 350 ml.
Sublimatie Mok, Keramiek, 350 ml.

Ø 8.2 x 9.6 cm 36
Print Code: Q



04

02

06

08

Harnet 3894

Sublimation Mug, Ceramic, 350 ml.
Sublimations Tasse, Keramik, 350 ml.
Tasse Sublimation, Céramique, 350 ml.
Sublimatie Mok, Keramiek, 350 ml.

Ø 8.2 x 9.6 cm 36
Print Code: Q



04

07

19

03

05



350 ml



Bornel 3893

Sublimation Mug, Ceramic, 350 ml.
Sublimations Tasse, Keramik, 350 ml.
Tasse Sublimation, Céramique, 350 ml.
Sublimatie Mok, Keramiek, 350 ml.

Ø 8.2 x 9.6 cm 36
Print Code: Q



250 ml



Dolten 5183

Sublimation Mug, Ceramic, 250 ml.
Sublimations Tasse, Keramik, 250 ml.
Tasse Sublimation, Céramique, 250 ml.
Sublimatie Mok, Keramiek, 250 ml.

Ø 7.4 x 8.4 cm 48
Print Code: Q



350 ml



Kaffir 5184

Sublimation Mug, Ceramic, 350 ml.
Sublimations Tasse, Keramik, 350 ml.
Tasse Sublimation, Céramique, 350 ml.
Sublimatie Mok, Keramiek, 350 ml.

Ø 9 x 10 cm 36
Print Code: Q





Roset 1778

Sublimation Mug. Ceramic/ Cork. 420 ml.
 Sublimations Tasse. Keramik/ Kork. 420 ml.
 Tasse Sublimation. Céramique/ Liège. 420 ml.
 Sublimatie Mok. Keramiek/ Kurk. 420 ml.

📏 Ø 9 x 11 cm 📦 36 🖨️ Print Code: Q



Nala 20522

Sublimation Mug. Ceramic/ Cork. 350 ml.
 Sublimations Tasse. Keramik/ Kork. 350 ml.
 Tasse Sublimation. Céramique/ Liège. 350 ml.
 Sublimatie Mok. Keramiek/ Kurk. 350 ml.

📏 Ø 8.2 x 10.2 cm 📦 36 🖨️ Print Code: Q



Robleda 21091

Sublimation Mug. Ceramic. 350 ml.
 Sublimations Tasse. Keramik. 350 ml.
 Tasse Sublimation. Céramique. 350 ml.
 Sublimatie Mok. Keramiek. 350 ml.

📏 Ø 8.2 x 9.6 cm 📦 36 🖨️ Print Code: Q



Gover 6287

Sublimation Mug. Ceramic. 300 ml.
 Sublimations Tasse. Keramik. 300 ml.
 Tasse Sublimation. Céramique. 300 ml.
 Sublimatie Mok. Keramiek. 300 ml.

📏 Ø 8.6 x 8.5 cm 📦 36 🖨️ Print Code: Q



02

19

350 ml



Amira 1759

Sublimation Mug. Glas. 350 ml.
 Sublimations Tasse. Glas. 350 ml.
 Tasse Sublimation. Verre. 350 ml.
 Sublimatie Mok. Glas. 350 ml.

Ø 8 x 9.6 cm 36 Print Code: F(1), L1, Q



New

330 ml



Loter 20511

Sublimation Cup. Glas. 330 ml.
 Sublimations Trinkbecher. Glas. 330 ml.
 Verre Sublimation. Verre. 330 ml.
 Sublimatie Beker. Glas. 330 ml.

Ø 8.1 x 10 cm 36 Print Code: L1, Q



New

350 ml



Cervan 20516

Sublimation Mug. Glas. 350 ml.
 Sublimations Tasse. Glas. 350 ml.
 Tasse Sublimation. Verre. 350 ml.
 Sublimatie Mok. Glas. 350 ml.

Ø 8 x 9.6 cm 36 Print Code: L1, Q



New

350 ml



Osaka 20512

Sublimation Mug. Glas. 350 ml.
 Sublimations Tasse. Glas. 350 ml.
 Tasse Sublimation. Verre. 350 ml.
 Sublimatie Mok. Glas. 350 ml.

Ø 8 x 9.6 cm 36 Print Code: L1, Q



New

500 ml



Oxia 20510

Sublimation Jug. Glass. 500 ml.
Sublimations Krug. Glas. 500 ml.
Carafe Sublimation. Verre. 500 ml.
Sublimatie Kan. Glas. 500 ml.

Ø 8 x 15 cm 20 Print Code: L1, Q



New

700 ml



Heim 20513

Sublimation Jug. Ceramic. 700 ml.
Sublimations Krug. Keramik. 700 ml.
Carafe Sublimation. Céramique. 700 ml.
Sublimatie Kan. Keramiek. 700 ml.

Ø 10.3 x 13.8 cm 20 Print Code: Q



350 ml



Bardot 5837

Sublimation Mug. Ceramic. 350 ml.
Sublimations Tasse. Keramik. 350 ml.
Tasse Sublimation. Céramique. 350 ml.
Sublimatie Mok. Keramiek. 350 ml.

Ø 8.2 x 9.6 cm 36 Print Code: F(1), Q



HOT LIQUID



MAGIC MUG SUBLIMATION

This mug has an outer coating specially designed for sublimation printing, its marking will be imperceptible by the black coating and will magically appear on contact with the hot liquid, wow!

New

400 ml



Fonix 20514

Sublimation Jar. Glass/ Bamboo. 400 ml.
Sublimations Krug. Glas/ Bambus. 400 ml.
Pot Sublimation. Verre/ Bambou. 400 ml.
Sublimatie Pot. Glas/ Bamboe. 400 ml.

Ø 7.7 x 12.5 cm 30 Print Code: L1, Q

480 ml



Mystral 20523

Mug. Ceramic/ Bamboo. 480 ml.
Tasse. Keramik/ Bambus. 480 ml.
Tasse. Céramique/ Bambou. 480 ml.
Mok. Keramiek/ Bamboe. 480 ml.

📏 Ø 8.8 x 11.5 cm 📦 24 🖨️ Print Code: F(4), L1



New

500 ml



Beverly 20235

Mug. Ceramic. 500 ml. Extendable Stainless Steel/ Cork Drink Stirrer Included.
Tasse. Keramik. 500 ml. Ausziehbares Rostfreier Stahl/ Kork Drink Rührer Inklusiv.
Tasse. Céramique. 500 ml. Agitateur Extensible Acier Inox/ Liège Inclusif.
Mok. Keramiek. 500 ml. Verlengbare Roerstaafje Roestvrij Staal/ Kurk Inclusief.

📏 Ø 9 x 11.5 cm 📦 24 🖨️ Print Code: F(4), L1



LIMITED
edition
EXPERIENCE

350 ml

Haruncal 1358

Mug. Ceramic/ Wood. 350 ml.
Tasse. Keramik/ Holz. 350 ml.
Tasse. Céramique/ Bois. 350 ml.
Mok. Keramiek/ Hout. 350 ml.

📏 Ø 8.5 x 11 cm 📦 30 🖨️ Print Code: F(4), L2





Bokun 6585

01

Mug. Ceramic/ Cork. 420 ml.
Tasse. Keramik/ Kork. 420 ml.
Tasse. Céramique/ Liège. 420 ml.
Mok. Keramik/ Kurk. 420 ml.

☰ Ø 9 x 11 cm 📖 36 🔄 Print Code: F(4)



02



Melmak 20520

04

Mug. Ceramic/ Cork. 350 ml.
Tasse. Keramik/ Kork. 350 ml.
Tasse. Céramique/ Liège. 350 ml.
Mok. Keramik/ Kurk. 350 ml.

☰ Ø 8.2 x 10.2 cm 📖 36 🔄 Print Code: F(4)



01

13



06

03

02



Yotel 6586

Mug. Ceramic/ Bamboo. 370 ml.
Tasse. Keramik/ Bambus. 370 ml.
Tasse. Céramique/ Bambou. 370 ml.
Mok. Keramik/ Bamboe. 370 ml.

☰ Ø 8.2 x 10.5 cm 📖 36 🔄 Print Code: F(4), L2



Zenara 20521

02

Mug. Ceramic/ Bamboo. 350 ml.
Tasse. Keramik/ Bambus. 350 ml.
Tasse. Céramique/ Bambou. 350 ml.
Mok. Keramik/ Bamboe. 350 ml.

☰ Ø 8.6 x 9.1 cm 📖 36 🔄 Print Code: F(4), L2



01



300 ml

470 ml

370 ml

Byren 1758

Mug. Ceramic. 300 ml.
Tasse. Keramik. 300 ml.
Tasse. Céramique. 300 ml.
Mok. Keramiek. 300 ml.

📏 Ø 8.6 x 8.5 cm 📦 36 🔄 Print Code: F(4)

Leslie 1757

Mug. Ceramic. 470 ml.
Tasse. Keramik. 470 ml.
Tasse. Céramique. 470 ml.
Mok. Keramiek. 470 ml.

📏 Ø 9.6 x 10.5 cm 📦 36 🔄 Print Code: F(4)

Malik 1756

Mug. Ceramic. 370 ml.
Tasse. Keramik. 370 ml.
Tasse. Céramique. 370 ml.
Mok. Keramiek. 370 ml.

📏 Ø 8.2 x 9.8 cm 📦 36 🔄 Print Code: F(4)

330 ml

🇪🇺 Made in Europe

Sintax 2659

Mug. Clay. 330 ml.
Tasse. Schlamm. 330 ml.
Tasse. Argile. 330 ml.
Mok. Modder. 330 ml.

📏 Ø 8.1 x 9.8 cm 📦 36 🔄 Print Code: F(4)

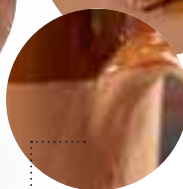

HAND MADE,
IMPERFECT FINISH

330 ml

🇪🇺 Made in Europe

Lixus 2660

Mug. Clay. 330 ml.
Tasse. Schlamm. 330 ml.
Tasse. Argile. 330 ml.
Mok. Modder. 330 ml.

📏 Ø 8.3 x 10.4 cm 📦 36 🔄 Print Code: F(4)





New

420 ml

04

Kubaya 20518

Mug. Ceramic. 420 ml.
Tasse. Keramik. 420 ml.
Tasse. Céramique. 420 ml.
Mok. Keramiek. 420 ml.



13

06

08

02

01

☞ Ø 8.2 x 11 cm ☞ 36 ☞ Print Code: F(4)



New

300 ml

06

Hilman 20519

Mug. Ceramic. 300 ml.
Tasse. Keramik. 300 ml.
Tasse. Céramique. 300 ml.
Mok. Keramiek. 300 ml.



01

13

08

02

04

☞ Ø 8.6 x 8.7 cm ☞ 36 ☞ Print Code: F(4)



330 ml

Larray 1281

Mug. Ceramic/ Bamboo. 330 ml.
Tasse. Keramik/ Bambou. 330 ml.
Tasse. Céramique/ Bambou. 330 ml.
Mok. Keramiek/ Bamboe. 330 ml.

☞ Ø 9.1 x 9.1 cm ☞ 36 ☞ Print Code: F(4)



350 ml

01

Lanay 1256

Mug. Ceramic. 350 ml.
Tasse. Keramik. 350 ml.
Tasse. Céramique. 350 ml.
Mok. Keramiek. 350 ml.

☞ Ø 9.2 x 8.5 cm ☞ 36 ☞ Print Code: F(4)



18

04

New

300 ml



300 ml



21

Maiba 20517

Mug. Ceramic. 300 ml.
Tasse. Keramik. 300 ml.
Tasse. Céramique. 300 ml.
Mok. Keramiek. 300 ml.



02

04

01

13

☞ Ø 8.6 × 9.3 cm ☞ 36 ☞ Print Code: F(4)

Sinor 5685

Mug. Ceramic. 300 ml.
Tasse. Keramik. 300 ml.
Tasse. Céramique. 300 ml.
Mok. Keramiek. 300 ml.



01

02

03

16

☞ Ø 8.6 × 8.5 cm ☞ 36 ☞ Print Code: F(4)

470 ml



02

Mabery 5686

Mug. Ceramic. 470 ml.
Tasse. Keramik. 470 ml.
Tasse. Céramique. 470 ml.
Mok. Keramiek. 470 ml.



01

03

19

05

04

☞ Ø 9.6 × 10.5 cm ☞ 36 ☞ Print Code: F(4)

350 ml



08

Kario 1255

Mug. Ceramic. 350 ml.
Tasse. Keramik. 350 ml.
Tasse. Céramique. 350 ml.
Mok. Keramiek. 350 ml.



02

06

03

☞ Ø 9.8 × 8.4 cm ☞ 36 ☞ Print Code: F(4)

Impex 3144

Mug. Ceramic. 370 ml.
Tasse. Keramik. 370 ml.
Tasse. Céramique. 370 ml.
Mok. Keramiek. 370 ml.

☞ Ø 8.2 × 9.8 cm ☞ 36 ☞ Print Code: F(4)



Daimy 5182

Mug. Ceramic. 250 ml.
Tasse. Keramik. 250 ml.
Tasse. Céramique. 250 ml.
Mok. Keramiek. 250 ml.

☞ Ø 7.4 × 8.4 cm ☞ 48 ☞ Print Code: F(4)



Tarbox 4749

Mug. Ceramic. 380 ml.
Tasse. Keramik. 380 ml.
Tasse. Céramique. 380 ml.
Mok. Keramiek. 380 ml.

☞ Ø 9.1 × 8.6 cm ☞ 36 ☞ Print Code: F(4)



Zifor 3963

Mug. Ceramic. 370 ml.
Tasse. Keramik. 370 ml.
Tasse. Céramique. 370 ml.
Mok. Keramiek. 370 ml.

☞ Ø 8.2 × 9.8 cm ☞ 36 ☞ Print Code: F(4)



Matt

FINISH



300 ml

Bercom 6312

Mug, Ceramic, 300 ml.
Tasse, Keramik, 300 ml.
Tasse, Céramique, 300 ml.
Mok, Keramiek, 300 ml.

📏 Ø 8.6 × 8.5 cm 📦 36 🖨️ Print Code: F(4)



350 ml



SUBLIMATION

Talmex 6286

Sublimation Mug, Ceramic, 350 ml.
Sublimations Tasse, Keramik, 350 ml.
Tasse Sublimation, Céramique, 350 ml.
Sublimatie Mok, Keramiek, 350 ml.

📏 Ø 8.2 × 9.6 cm 📦 36 🖨️ Print Code: Q



480 ml



Korpus 6311

Mug, Ceramic, 480 ml.
Tasse, Keramik, 480 ml.
Tasse, Céramique, 480 ml.
Mok, Keramiek, 480 ml.

📏 Ø 8.8 × 14.9 cm 📦 20 🖨️ Print Code: F(4)



23

Renkur 5984

Mug. Ceramic. 350 ml.
Tasse. Keramik. 350 ml.
Tasse. Céramique. 350 ml.
Mok. Keramiek. 350 ml.

☞ Ø 8.2 x 9.6 cm ☞ 36 ☞ Print Code: F(4), L2



09

SPECIAL LASER ENGRAVING

These mugs have an outer coating especially designed for laser engraving. This will ensure that your advertising or brand is perfectly engraved to match the interior colour of your chosen mug.

Estas tazas tienen un recubrimiento especialmente diseñado para grabado láser, con el que conseguirá que su publicidad o marca quede perfectamente grabada a juego con el color del interior de la taza elegida.



350 ml

11

Lousa 5291

Mug. Ceramic. 350 ml.
Tasse. Keramik. 350 ml.
Tasse. Céramique. 350 ml.
Mok. Keramiek. 350 ml.

☞ Ø 8.2 x 9.6 cm ☞ 36 ☞ Print Code: F(1), L2



350 ml

05

Bafy 5290

Mug. Ceramic. 350 ml.
Tasse. Keramik. 350 ml.
Tasse. Céramique. 350 ml.
Mok. Keramiek. 350 ml.

☞ Ø 8.2 x 9.6 cm ☞ 36 ☞ Print Code: F(1), L2



07

16

22

03



350 ml

19

Kulmer 5836

Mug. Ceramic. 350 ml.
Tasse. Keramik. 350 ml.
Tasse. Céramique. 350 ml.
Mok. Keramiek. 350 ml.

☞ Ø 8.2 x 9.6 cm ☞ 36 ☞ Print Code: F(4), L2



05

07

03

02

01

04





350 ml

03

Cotes 9459

Mug. Ceramic. 350 ml.
Tasse. Keramik. 350 ml.
Tasse. Céramique. 350 ml.
Mok. Keramiek. 350 ml.

☞ 8.5 x 10.5 cm ☞ 36
☞ Print Code: F(4)



19



04



07



Samay 5688

Mug. Ceramic. 300 ml.
Tasse. Keramik. 300 ml.
Tasse. Céramique. 300 ml.
Mok. Keramiek. 300 ml.

☞ 8.3 x 10.2 cm ☞ 36 ☞ Print Code: F(4)

300 ml



Solara 20808

Jug, Stainless Steel. 450 ml.
Krug, Rostfreier Stahl. 450 ml.
Carafe, Acier Inox. 450 ml.
Kan, Roestvrij Staal. 450 ml.

Print Code: F(1), L1

450 ml



350 ml

Brant 6999

GLASS

Mug, Glass. 350 ml. Not suitable for sublimation.
Tasse, Glas. 350 ml. Nicht geeignet für sublimation.
Tasse, Verre. 350 ml. Ne convient pas à la sublimation.
Mok, Glas. 350 ml. Niet geschikt voor sublimatie.

Print Code: F(1)

Tilton 6313

Mug, Ceramic. 700 ml.
Krug, Keramik. 700 ml.
Carafe, Céramique. 700 ml.
Kan, Keramiek. 700 ml.

Print Code: F(4)

700 ml



Tilton 6313

Lutin 5194

Mug, Ceramic. 80 ml.
Tasse, Keramik. 80 ml.
Tasse, Céramique. 80 ml.
Mok, Keramiek. 80 ml.

Print Code: F(4)

80 ml



Lutin 5194

08 TO GO





**REUSABLE,
PRACTICAL,
LIFESTYLE**



New

1.4L

Glaxia 20610

Cool Bag, Polyester 600D RPET/ Aluminium, Lunch Box Recycled PP, 2 Compartments 700 ml Included.
 Kühltasche, Polyester 600D RPET/ Aluminium, Lunch Box PP Recycling, 2 Abteilungen 700 ml inklusive.
 Glacière, Polyester 600D RPET/ Aluminium, Gamelle PP Recyclé, 2 Compartiments 700 ml Inclusie.
 Koeltas, Polyester 600D RPET/ Aluminium, Lunch Box Gerecycled PP, 2 Compartimenten 700 ml Inclusief.
 25 x 15 x 15 cm 20 Print Code: G(1), N(8), W



New

4L



Vilan 20619

Cool Bag, PP, 4 L.
 Kühltasche, PP, 4 L.
 Glacière, PP, 4 L.
 Koeltas, PP, 4 L.
 27 x 18.5 x 16 cm 4 Print Code: K(1)



1L

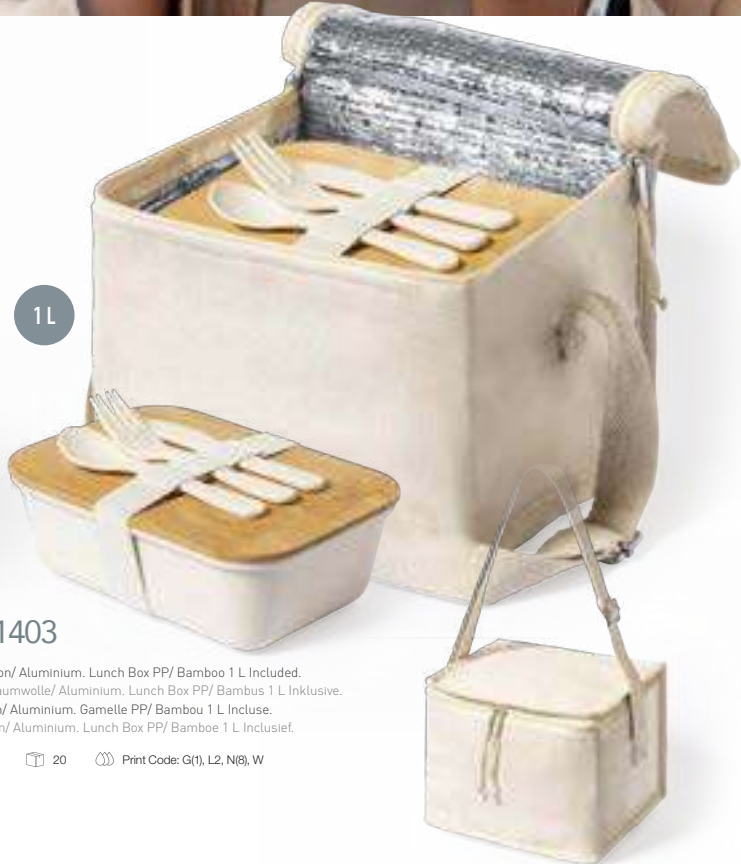

Parum 1403

Cool Bag, 100% Cotton/ Aluminium, Lunch Box PP/ Bamboo 1 L Included.
 Kühltasche, 100% Baumwolle/ Aluminium, Lunch Box PP/ Bambus 1 L inklusive.
 Glacière, 100% Coton/ Aluminium, Gamelle PP/ Bambou 1 L Inclusie.
 Koeltas, 100% Katoen/ Aluminium, Lunch Box PP/ Bamboe 1 L Inclusief.
 22 x 17 x 17 cm 20 Print Code: G(1), L2, N(8), W

**FOOD
GRADE**
quality certified
**CERTIFIED FOOD-GRADE
PRODUCTS**

371

TOGO

1.4L



Graftan 1479

Lunch Box, PP/ Bambou. 2 Compartments 700 ml.
Lunch Box, PP/ Bambou. 2 Abteilungen 700 ml.
Gamelle, PP/ Bambou. 2 Compartiments 700 ml.
Lunch Box, PP/ Bamboe. 2 Compartimenten 700 ml.

18.3 x 10.5 x 9.6 cm 30
Print Code: F(1), L2, W



1.4L

13



02



Bawar 1126

Lunch Box, PP/ Bambou. 2 Compartments 700 ml.
Lunch Box, PP/ Bambou. 2 Abteilungen 700 ml.
Gamelle, PP/ Bambou. 2 Compartiments 700 ml.
Lunch Box, PP/ Bamboe. 2 Compartimenten 700 ml.

18 x 9.6 x 10.6 cm 30
Print Code: F(1), L2, W



1L

13



02

Thadan 1125

Lunch Box, PP/ Bambou. 1 L.
Lunch Box, PP/ Bambou. 1 L.
Gamelle, PP/ Bambou. 1 L.
Lunch Box, PP/ Bamboe. 1 L.

20 x 7 x 14 cm 20
Print Code: F(1), L2, W



Weaver 1739

Lunch Box. PP. 1 L.
Lunch Box. PP. 1 L.
Gamelle. PP. 1 L.
Lunch Box. PP. 1 L.

1 L

19.8 x 6.8 x 13.7 cm 20 Print Code: E(1), W



700 ml

Harxem 1124

Lunch Box. PP. 700 ml.
Lunch Box. PP. 700 ml.
Gamelle. PP. 700 ml.
Lunch Box. PP. 700 ml.

16.5 x 5 x 11.2 cm 50 Print Code: E(1)



New

450 ml

Tixor 20612

Sandwich Lunch Box. PP. 450 ml.
Sandwich Lunch Box. PP. 450 ml.
Gamelle Sandwich. PP. 450 ml.
Boterhammen-Lunchbox. PP. 450 ml.

13 x 5 x 13.5 cm 160 / 40 Print Code: E(1)



Dranel 1725

Cutlery Set. PP. 3 Pieces.
Besteckset. PP. 3 Stück.
Set Couverts. PP. 3 Pièces.
Bestek Set. PP. 3 Stuks.

16.5 x 2.5 x 5 cm 100 / 50 Print Code: E(1), B(4), W



Sainod 1161

Foldable Cup. PP. 220 ml.
Faltbarer Trinkbecher. PP. 220 ml.
Verre Pliable. PP. 220 ml.
Opvouwbare Beker. PP. 220 ml.

220 ml

6.8 x 9 cm 100 / 50 Print Code: D(4), W



600 ml

Sariul 6695

Lunch Box. Stainless Steel/ Bamboo. 600 ml.
Lunch Box. Rostfreier Stahl/ Bambus. 600 ml.
Gamelle. Acier Inox/ Bambou. 600 ml.
Lunch Box. Roestvrij Staal/ Bamboe. 600 ml.

16.4 x 5.6 x 11.5 cm 30 Print Code: F(1), L1, L2



700 ml

Bejar 6799

Lunch Box. Glass/ Bamboo. 700 ml.
Lunch Box. Glas/ Bambus. 700 ml.
Gamelle. Verre/ Bambou. 700 ml.
Lunch Box. Glas/ Bamboe. 700 ml.

17.2 x 6.7 x 12.7 cm 20 Print Code: F(1), L1, L2



Glass

LIMITED
edition
EXPERIENCE



1L

Lanrok 1337

Lunch Box. Stainless Steel/ Bamboo/ Cork. 1 L.
Lunch Box. Rostfreier Stahl/ Bambus/ Kork. 1 L.
Gamelle. Acier Inox/ Bambou/ Liège. 1 L.
Lunch Box. Roestvrij Staal/ Bamboe/ Kurk. 1 L.

18.5 x 7.7 x 13.8 cm 15 Print Code: F(1), L2, W



LIMITED
edition
EXPERIENCE



730 ml

Crisbut 1338

Lunch Box. Borosilicate Glass/ Bamboo/ Cork. 730 ml.
Lunch Box. Borosilikat Glas/ Bambus/ Kork. 730 ml.
Gamelle. Verre Borosilikate/ Bambou/ Liège. 730 ml.
Lunch Box. Borosilikate Glas/ Bamboe/ Kurk. 730 ml.

19.8 x 7 x 15 cm 10 Print Code: F(1), L2, W





CERTIFIED FOOD-GRADE
PRODUCTS

Chosal 2633

Noix 2500

Travil 2634

Zenex 2635

Made in Europe

Chosal 2633

Lunch Box. PP. 1 L.
Lunch Box. PP. 1 L.
Gamelle. PP. 1 L.
Lunch Box. PP. 1 L.

19.6 x 6.5 x 16 cm 60 Print Code: E(1)



1L

Noix 2500

Sandwich Lunch Box. PP. 450 mL.
Sandwich Lunch Box. PP. 450 mL.
Gamelle Sandwich. PP. 450 mL.
Boterhammen-Lunchbox. PP. 450 mL.

13 x 5 x 13.5 cm 160 / 40 Print Code: E(1)



450 ml

Made in Europe

Travil 2634

Lunch Box. PP. 1 L.
Lunch Box. PP. 1 L.
Gamelle. PP. 1 L.
Lunch Box. PP. 1 L.

17.3 x 6 x 17.3 cm 60 Print Code: E(1)



1L

Made in Europe

Zenex 2635

Lunch Box. PP. 1 L.
Lunch Box. PP. 1 L.
Gamelle. PP. 1 L.
Lunch Box. PP. 1 L.

22.5 x 6.2 x 13.7 cm 60 Print Code: E(1)



1L



Vilma 1740

Lunch Box, PP, 2 Compartments 700 ml.
Lunch Box, PP, 2 Abteilungen 700 ml.
Gamelle, PP, 2 Compartiments 700 ml.
Lunch Box, PP, 2 Compartimenten 700 ml.

18.2 x 9.4 x 10.4 cm 30 Print Code: E(t), F(t), W

1.4 L



Sandix 1738

Lunch Box, PP, 1 L.
Lunch Box, PP, 1 L.
Gamelle, PP, 1 L.
Lunch Box, PP, 1 L.

19 x 11.5 x 6.7 cm 20 Print Code: E(t), W

1 L



1.4 L

Fandex 6708

Antibacterial Lunch Box, PP, 2 Compartments 700 ml.
Antibakteriell Lunch Box, PP, 2 Abteilungen 700 ml.
Gamelle Antibacterienne, PP, 2 Compartiments 700 ml.
Antibacterieel Lunch Box, PP, 2 Compartimenten 700 ml.

18.7 x 12.1 x 10.6 cm 30 Print Code: E(t), W



Molkas 6675

Lunch Box, PLA 100% Compostable, 1 L.
Lunch Box, PLA 100% Kompostierbar, 1 L.
Gamelle, PLA 100% Compostable, 1 L.
Lunch Box, PLA 100% Composteerbaar, 1 L.

19 x 8.5 x 11 cm 20 Print Code: E(t), W

1 L

100% COMPOSTABLE
BIODEGRADABLE



SE ME,
AM ECO-FRIENDLY



800 ml

Plastil 1938

Lunch Box. Stainless Steel/ Bamboo. 800 ml. Safety Catch.
Lunch Box. Rostfreier Stahl/ Bambus. 800 ml. Sicherheitsverschluss.
Gamelle. Acier Inox/ Bambou. 800 ml. Fermeture Sécurité.
Lunch Box. Roestvrij Staal/ Bamboe. 800 ml. Veiligheidsluiting.

17 x 12.1 x 6 cm 30 Print Code: F(1), L2



800 ml

Truit 1744

Lunch Box. Stainless Steel/ Bamboo. 800 ml.
Lunch Box. Rostfreier Stahl/ Bambus. 800 ml.
Gamelle. Acier Inox/ Bambou. 800 ml.
Lunch Box. Roestvrij Staal/ Bamboe. 800 ml.

Ø 16.5 x 7.5 cm 40 Print Code: F(1), L2, W



Tusvik 1745

Lunch Box. Stainless Steel/ Bamboo. 1.4 L.
Lunch Box. Rostfreier Stahl/ Bambus. 1.4 L.
Gamelle. Acier Inox/ Bambou. 1.4 L.
Lunch Box. Roestvrij Staal/ Bamboe. 1.4 L.

16.1 x 7.5 x 16.1 cm 20 Print Code: F(1), L2

1.4 L



220 ml

Daibak 1730

Foldable Cup. Stainless Steel. 220 ml.
 Faltbarer Trinkbecher. Rostfreier Stahl. 220 ml.
 Verre Pliable. Acier Inox. 220 ml.
 Opvouwbare Beker. Roestvrij Staal. 220 ml.

📏 Ø 7.8 × 8 cm 📦 100 / 50 🏷️ Print Code: E(1), L1



750 ml

Yalac 1123

Lunch Box. Stainless Steel. 750 ml. Safety Catch.
 Lunch Box. Rostfreier Stahl. 750 ml. Sicherheitsverschluss.
 Gamelle. Acier Inox. 750 ml. Fermeture Sécurité.
 Lunch Box. Roestvrij Staal. 750 ml. Veiligheidsluiting.

📏 17 × 5.7 × 11.9 cm 📦 30 🏷️ Print Code: F(1), L2



Glass



1 L

Tuber 6915

Lunch Box. Borosilicate Glass. 1 L.
 Lunch Box. Borosilikat Glas. 1 L.
 Gamelle. Verre Borosilicate. 1 L.
 Lunch Box. Borosilicate Glas. 1 L.

📏 20.2 × 6.7 × 15.2 cm 📦 15 🏷️ Print Code: F(1)



500 ml

Veket 1482

Thermal Lunch Box. PP/ Stainless Steel. 500 ml.
 Wärme Lunch Box. PP/ Rostfreier Stahl. 500 ml.
 Gamelle Thermique. PP/ Acier Inox. 500 ml.
 Thermo Lunch Box. PP/ Roestvrij Staal. 500 ml.

📏 21.3 × 6.4 × 11.3 cm 📦 30 🏷️ Print Code: F(1)



Electric Lunch Box

378

TO GO



1 L



Calpy 6724

Electric Lunch Box. ABS. 1 L.
Elektrische Lunch Box. ABS. 1 L.
Gamelle Électrique. ABS. 1 L.
Elektrische Lunch Box. ABS. 1 L.

23.5 x 16.5 x 11 cm 20 Print Code: F(1)



Thermal Lunch Box

850 ml



Dixier 6916

Thermal Lunch Box. PP/ Stainless Steel. 2 Compartments 350 and 500 mL.
Wärme Lunch Box. PP/ Rostfreier Stahl. 2 Abteilungen 350 und 500 mL.
Gamelle Thermique. PP/ Acier Inox. 2 Compartiments 350 et 500 mL.
Thermo Lunch Box. PP/ Roestvrij Staal. 2 Compartimenten 350 en 500 mL.

21.5 x 14 x 11.5 cm 20 Print Code: F(1)



INCREASES ITS
THERMAL ENDURANCE
CAPACITY BY ADDING
HOT WATER



06

750 ml



13



02



08

Shonka 1741

Lunch Box. Recycled Stainless Steel. 750 ml. Safety Catch.
Lunch Box. Recycling Rostfreier Stahl. 750 ml. Sicherheitsverschluss.
Gamelle. Acier Inox Recyclé. 750 ml. Fermeture Sécurité.
Lunch Box. Gerecycled Roestvrij Staal. 750 ml. Veiligheidsluiting.

☞ 17 x 5.7 x 11.9 cm ☞ 30 ☞ Print Code: F(1), L2



940 ml

Vickers 1742

Lunch Box. Recycled Stainless Steel/ Bamboe. 2 Compartments 340 and 600 ml. Safety Catch.
Lunch Box. Recycling Rostfreier Stahl/ Bambus. 2 Abteilungen 340 und 600 ml. Sicherheitsverschluss.
Gamelle. Acier Inox Recyclé/ Bamboe. 2 Compartiments 340 et 600 ml. Fermeture Sécurité.
Lunch Box. Gerecycled Roestvrij Staal/ Bamboe. 2 Compartimenten 340 en 600 ml. Veiligheidsluiting.

☞ 17 x 11.5 x 8.5 cm ☞ 30 ☞ Print Code: F(1), L2



made of recycled PP



New

08

01

06

220 ml

02

Jado 20197

Foldable Cup. Recycled PP. 220 ml.
Faltbarer Trinkbecher. PP Recycling. 220 ml.
Verre Pliable. PP Recyclé. 220 ml.
Opvouwbare Beker. Gerecycled PP. 220 ml.

☞ Ø 6.8 x 9 cm ☞ 100 / 50
☞ Print Code: D(4), W



New

08

Florax 20198

Cutlery Set. Recycled PP. 3 Pieces.
Besteckset. PP Recycling. 3 Stück.
Set Couverts. PP Recyclé. 3 Pièces.
Bestek Set. Gerecycled PP. 3 Stuks.

☞ 16.5 x 2.5 x 5 cm ☞ 100 / 50
☞ Print Code: B(4), E(1), W



06

01

02



New

01

900 ml

06

02

08

Alexia 20195

Lunch Box. Recycled PP. 900 ml. Safety Catch.
Lunch Box. PP Recycling. 900 ml. Sicherheitsverschluss.
Gamelle. PP Recyclé. 900 ml. Fermeture Sécurité.
Lunch Box. Gerecycled PP. 900 ml. Veiligheidsluiting.

☞ 21.5 x 6.4 x 11.9 cm ☞ 30 ☞ Print Code: F(1)

Lunch Box



New

600 ml



09

02

Zanka 20613

Lunch Box. Stainless Steel. 600 ml.
Lunch Box. Rostfreier Stahl. 600 ml.
Gamelle. Acier Inox. 600 ml.
Lunch Box. Roestvrij Staal. 600 ml.

Ø 8,7 × 14,5 cm 30 Print Code: F(1), L1

New

500 ml



Reuteman 20614

Lunch Box. PP/ Stainless Steel. 500 ml.
Lunch Box. PP/ Rostfreier Stahl. 500 ml.
Gamelle. PP/ Acier Inox. 500 ml.
Lunch Box. PP/ Roestvrij Staal. 500 ml.

Ø 9 × 12 cm 30 Print Code: F(1)

450 ml



Cambrix 1480

Lunch Box. Stainless Steel/ Bamboo/ Cork. 450 ml.
Lunch Box. Rostfreier Stahl/ Bambus/ Kork. 450 ml.
Gamelle. Acier Inox/ Bamboe/ Liège. 450 ml.
Lunch Box. Roestvrij Staal/ Bamboe/ Kurk. 450 ml.

Ø 10,1 × 15,4 cm 20 Print Code: F(1), L1

Reusable Cutlery set

381

TO GO



Tailung 1067

Cutlery Set. Stainless Steel. 5 Pieces. Polyester RPET Pouch.
Besteckset. Rostfreier Stahl. 5 Stück. Polyester RPET Etui.
Set Couverts. Acier Inox. 5 Pièces. Étui Polyester RPET.
Bestek Set. Roestvrij Staal. 5 Stuks. Polyester RPET Zakje.

7.5 x 24.5 x 2 cm 80 / 40 Print Code: G(1), L1, N(8)



Milner 20615

Cutlery Set. PP/ Bamboo. 5 Pieces.
Besteckset. PP/ Bambus. 5 Stück.
Set Couverts. PP/ Bambou. 5 Pièces.
Bestek Set. PP/ Bamboe. 5 Stuks.

16.5 x 2.7 x 4.5 cm 100 / 50
Print Code: E(1), B(4), L2, W



EXTENDABLE



Corpax 6887

Cutlery Set. Bamboo. 5 Pieces. Canvas Pouch.
Besteckset. Bambus. 5 Stück. Canvas Etui.
Set Couverts. Bambou. 5 Pièces. Étui Toile.
Bestek Set. Bamboe. 5 Stuks. Canvas Zakje.

6.5 x 22 x 2.5 cm 100 Print Code: N(8), C(4), L1



Plusin 6361

Cutlery Set. Bamboo. 3 Pieces. Cotton Pouch.
Besteckset. Bambus. 3 Stück. Baumwolle Etui.
Set Couverts. Bambou. 3 Pièces. Étui Coton.
Bestek Set. Bamboe. 3 Stuks. Katoen Zakje.

6.5 x 18 x 1 cm 300 / 100 Print Code: G(1), C(2), L1, N(8)



Basuky 1722

Cutlery Set. Stainless Steel/ Wood. 5 Pieces. Canvas Pouch.
Besteckset. Rostfreier Stahl/ Holz. 5 Stück. Canvas Etui.
Set Couverts. Acier Inox/ Bois. 5 Pièces. Étui Toile.
Bestek Set. Roestvrij Staal/ Hout. 5 Stuks. Canvas Zakje.

8.5 x 24 x 1.5 cm 100 / 50 Print Code: G(1), C(1), L1, N(8)



Socex 1063

Cutlery Set. Coconut. 3 Pieces. Cotton Pouch.
Besteckset. Kokosnuss. 3 Stück. Baumwolle Etui.
Set Couverts. Coco. 3 Pièces. Étui Coton.
Bestek Set. Kokosnoot. 3 Stuks. Katoen Zakje.

6.5 x 18 x 1 cm 300 / 100 Print Code: G(1), C(1), L1, N(8)



Malesh 1724

Cutlery Set. Stainless Steel. 5 Pieces. Velvet Pouch.
Besteckset. Rostfreier Stahl. 5 Stück. Wildleder Etui.
Set Couverts. Acier Inox. 5 Pièces. Étui Suédine.
Bestek Set. Roestvrij Staal. 5 Stuks. Fluweel Zakje.

8 x 23 x 1.5 cm 100 / 50 Print Code: G(1), C(1), L1, N(8)



Firux 1723

Straw Set. Stainless Steel. 2 Pieces. Reusable. Cleaner Included.
Velvet Pouch.
Strohalm Set. Rostfreier Stahl. 2 Stück. Wiederverwendbar.
Reiniger Inklusief. Wildleder Etui.
Set Paille. Acier Inox. 2 Pièces. Réutilisable. Nettoyant Inclusif.
Étui Suédine.
Rietjes Set. Roestvrij Staal. 2 Stuks. Herbruikbaar. Cleaner
Inclusief. Fluweel Zakje.

3.5 x 24.5 cm 400 / 100 Print Code: G(1), L1, N(8)





Jexor 20616

Straw, Stainless Steel, Extendable, Reusable, Cleaner Included.
 Strohhalm, Rostfreier Stahl, Ausziehbar, Wiederverwendbar, Reiniger Inklusive.
 Paille, Acier Inox, Extensible, Réutilisable, Nettoyant Inclusé.
 Rietje, Roestvrij Staal, Vertengbaar, Herbruikbaar, Cleaner Inclusief.

📏 Ø 1.4 × 12.3 cm 📦 300 / 50 🗑️ Print Code: E(1), L1

New



Ladix 6682

Antibacterial Straw, Silicone, Reusable.
 Antibakteriell Strohhalm, Silikon, Wiederverwendbar.
 Paille Antibacterienne, Silicone, Réutilisable.
 Antibacterieel Rietje, Siliconen, Herbruikbaar.

📏 Ø 5.4 × 2 cm 📦 500 / 100 🗑️ Print Code: C(4), W



Timex 6306

Straw, Stainless Steel/ Silicone, Extendable, Reusable, Cleaner Included.
 Strohhalm, Rostfreier Stahl/ Silikon, Ausziehbar, Wiederverwendbar, Reiniger Inklusive.
 Paille, Acier Inox/ Silicone, Extensible, Réutilisable, Nettoyant Inclusé.
 Rietje, Roestvrij Staal/ Siliconen, Verlengbaar, Herbruikbaar, Cleaner Inclusief.

📏 Ø 1.6 × 10.5 cm 📦 500 / 100 🗑️ Print Code: E(1), L1

Kalux 6282

Straw Set, Stainless Steel, 2 Pieces, Reusable, Cleaner Included, Cotton Pouch.
 Strohhalm Set, Rostfreier Stahl, 2 Stück, Wiederverwendbar, Reiniger Inklusive, Baumwolle Etui.
 Set Paille, Acier Inox, 2 Pièces, Réutilisable, Nettoyant Inclusé, Étui Coton.
 Rietjes Set, Roestvrij Staal, 2 Stuks, Herbruikbaar, Cleaner Inclusief, Katoen Zakje.

📏 3.5 × 24.5 cm 📦 400 / 100 🗑️ Print Code: G(1), L1, N(8)





Elendil 1095 08

Cool Bag. Polyester 600D RPET/ Aluminium.
Kühltasche. Polyester 600D RPET/ Aluminium.
Glacière. Polyester 600D RPET/ Aluminium.
Koelttas. Polyester 600D RPET/ Aluminium.

 25 x 15 x 15 cm  50  Print Code: G(1), N(8)

**NEW
COLOR**



02



06





Big Size



Botum 6849 08

Cool Bag. Polyester 600D RPET/ PEVA.
Kühltasche. Polyester 600D RPET/ PEVA.
Glacière. Polyester 600D RPET/ PEVA.
Koelttas. Polyester 600D RPET/ PEVA.

 31 x 24.5 x 20 cm  30  Print Code: G(1), N(8)

**NEW
COLOR**



02



06



Stacy 1247

Cool Bag. Polyester 600D RPET/ PEVA/ Aluminium. 2 Compartments.
Kühltasche. Polyester 600D RPET/ PEVA/ Aluminium. 2 Abteilungen.
Glacière. Polyester 600D RPET/ PEVA/ Aluminium. 2 Compartiments.
Koelttas. Polyester 600D RPET/ PEVA/ Aluminium. 2 Compartimenten.

 22 x 20 x 14 cm  50  Print Code: G(1), N(8)

COOL
COMPARTMENT

HEAT
COMPARTMENT





Hartman 20617

Cool Bag. Polyester 600D RPET/ Aluminium.
Kühltasche. Polyester 600D RPET/ Aluminium.
Glacière. Polyester 600D RPET/ Aluminium.
Koeltas. Polyester 600D RPET/ Aluminium.

 23 x 20.5 x 16 cm  50  Print Code: G(1), N(8)





06



08

Gunnur 1733

Cool Bag. Polyester 600D RPET/ PEVA.
Kühltasche. Polyester 600D RPET/ PEVA.
Glacière. Polyester 600D RPET/ PEVA.
Koeltas. Polyester 600D RPET/ PEVA.

 25 x 24 x 15 cm  20
 Print Code: G(1), N(8)



02



06



06

Teindor 1732

Cool Bag. Polyester 600D RPET/ PEVA.
Kühltasche. Polyester 600D RPET/ PEVA.
Glacière. Polyester 600D RPET/ PEVA.
Koeltas. Polyester 600D RPET/ PEVA.

 30 x 24 x 19.5 cm  30
 Print Code: G(1), N(8)



08

02



Chandak 1736

Cool Bag. Polyester 600D RPET/ PU/ Aluminium.
Kühltasche. Polyester 600D RPET/ PU/ Aluminium.
Glacière. Polyester 600D RPET/ Similicuir/ Aluminium.
Koelttas. Polyester 600D RPET/ PU/ Aluminium.

30 x 26 x 20 cm 30 Print Code: G(1), N(8)



Kumak 1735

Cool Bag. Polyester 600D RPET/ PU/ PEVA.
Kühltasche. Polyester 600D RPET/ PU/ PEVA.
Glacière. Polyester 600D RPET/ Similicuir/ PEVA.
Koelttas. Polyester 600D RPET/ PU/ PEVA.

20 x 27 x 13 cm 30 Print Code: G(1), N(8)

NATURAL CORK



Mathia 1092

Cool Bag. Cork/ Aluminium.
Kühltasche. Cork/ Aluminium.
Glacière. Liège/ Aluminium.
Koelttas. Kurk/ Aluminium.

21 x 18 x 18 cm 100/50 Print Code: G(1), N(8)



Lumilda 1091

Thermal Bag. Cork/ Aluminium.
Wärme Tasche. Cork/ Aluminium.
Sac Thermique. Liège/ Aluminium.
Thermo-Tasje. Kurk/ Aluminium.

20 x 32 x 8 cm 100/10
Print Code: G(1), N(8)





Bromir 1093

Thermal Bag. 100% Cotton/ Aluminium.
Wärme Tasche. 100% Baumwolle/ Aluminium.
Sac Thermique. 100% Coton/ Aluminium.
Thermo-Tasje. 100% Katoen/ Aluminium.

 19 x 32 x 12 cm  100 / 50  Print Code: G(1), N(8)



Lonfen 1094

Cool Bag. 100% Cotton/ Aluminium.
Kühltasche. 100% Baumwolle/ Aluminium.
Glacière. 100% Coton/ Aluminium.
Koeltas. 100% Katoen/ Aluminium.

 22 x 17 x 17 cm  50 / 25
 Print Code: G(1), N(8)



Trixen 20618

Cool Bag. 100% Recycled Cotton/ PEVA.
Kühltasche. 100% Recycling Baumwolle/ PEVA.
Glacière. 100% Coton Recyclé/ PEVA.
Koeltas. 100% Gerecycled Katoen/ PEVA.

 30 x 18 x 14 cm  50  Print Code: G(1), N(8)



Ponix 6816

Cool Bag. Laminated Jute/ Cotton/ Aluminium.
Kühltasche. Laminiertes Jutestoff/ Baumwolle/ Aluminium.
Glacière. Jute Laminé/ Coton/ Aluminium.
Koeltas. Gelamineerd Jute/ Katoen/ Aluminium.

 21 x 23 x 16 cm  50  Print Code: G(1), N(8)

Presli 20624

Cool Bag. Laminated Jute/ Cotton/ Aluminium.
Kühltasche. Laminiertes Jutestoff/ Baumwolle/ Aluminium.
Glacière. Jute Laminé/ Coton/ Aluminium.
Koeltas. Gelamineerd Jute/ Katoen/ Aluminium.

 43 x 34 x 20 cm  40  Print Code: G(1), N(8)

Linax 1100

Thermal Bag. 100% Cotton/ Laminated Jute/ Aluminium.
Wärme Tasche. 100% Baumwolle/ Laminiertes Jutestoff/ Aluminium.
Sac Thermique. 100% Coton/ Jute Laminé/ Aluminium.
Thermo-Tasje. 100% Katoen/ Gelamineerd Jute/ Aluminium.

 43 x 33 x 14 cm  50 / 10  Print Code: G(1), N(8)

Zayka 6812

Cool Bag. Laminated Recycled Paper/ Aluminium.
Kühltasche. Laminiertes Recycling Papier/ Aluminium.
Glacière. Papier Recyclé Laminé/ Aluminium.
Koeltas. Gelamineerd Gerecycled Papier/ Aluminium.

21 x 15 x 15 cm 200 / 25 Print Code: G(1)



Saban 6372

Thermal Bag. Laminated Recycled Paper/ Aluminium.
Wärme Tasche. Laminiertes Recycling Papier/ Aluminium.
Sac Thermique. Papier Recyclé Laminé/ Aluminium.
Thermo-Tasje. Gelamineerd Gerecycled Papier/ Aluminium.

43 x 33 x 14 cm 100 Print Code: G(1)



Saban 6372

Zayka 6812



Kasam 1090

Cool Bag. Laminated Recycled Paper/ Aluminium.
Kühltasche. Laminiertes Recycling Papier/ Aluminium.
Glacière. Papier Recyclé Laminé/ Aluminium.
Koeltas. Gelamineerd Gerecycled Papier/ Aluminium.

20 x 23 x 13 cm 100 / 50 Print Code: G(1)



Bapom 6064

Thermal Bag. Laminated Recycled Paper/ Aluminium.
Wärme Tasche. Laminiertes Recycling Papier/ Aluminium.
Sac Thermique. Papier Recyclé Laminé/ Aluminium.
Thermo-Tasje. Gelamineerd Gerecycled Papier/ Aluminium.

19 x 32 x 12 cm 100 / 50 Print Code: G(1)



03

Rumbix 6092

Thermal Bag. Laminated Recycled Paper/ Aluminium.
Wärme Tasche. Laminiertes Recycling Papier/ Aluminium.
Sac Thermique. Papier Recyclé Laminé/ Aluminium.
Thermo-Tasje. Gelamineerd Gerecycled Papier/ Aluminium.

20 x 25 x 10 cm 100 / 50
Print Code: G(1)

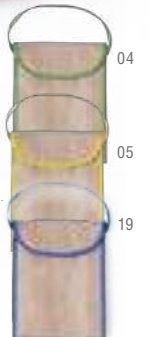

04

05

19



Akiles 1720

Thermal Snacks Holder. Laminated Recycled Paper/ PEVA.
 Wärme Lunch Box Tasche. Laminiertes Recycling Papier/ PEVA.
 Lunch-Box Thermique. Papier Recyclé Laminé/ PEVA.
 Thermo Boterhammentrommel. Gelamineerd Gerecycled Papier/ PEVA.

18 x 18 x 1 cm 500 / 50 Print Code: F(1)



Kalkin 1721

Thermal Snacks Holder. Polyester 600D RPET/ PEVA.
 Wärme Lunch Box Tasche. Polyester 600D RPET/ PEVA.
 Lunch-Box Thermique. Polyester 600D RPET/ PEVA.
 Thermo Boterhammentrommel. Polyester 600D RPET/ PEVA.

19 x 18.5 x 1 cm 100 / 50
 Print Code: F(1), N(8)



UNFOLDING



02



03

Batuk 1719

Thermal Sandwich Holder. Laminated Recycled Paper/ Aluminium.
 Wärme Lunch Box Tasche. Laminiertes Recycling Papier/ Aluminium.
 Lunch-Box Thermique. Papier Recyclé Laminé/ Aluminium.
 Thermo Boterhammentrommel. Gelamineerd Gerecycled Papier/ Aluminium.

21 x 8 x 7.5 cm 300 / 25
 Print Code: E(1), N(8)

Rufus 4028

Thermal Sandwich Holder. PVC/ Aluminium.
 Wärme Lunch Box Tasche. PVC/ Aluminium.
 Lunch-Box Thermique. PVC/ Aluminium.
 Thermo Boterhammentrommel. PVC/ Aluminium.

21 x 8 x 7.5 cm 300 / 25
 Print Code: E(1), N(8)



04

01

05

19



03

Bemel 4364

Cool Bag. Polyester 600D/ PEVA.
Kühltasche. Polyester 600D/ PEVA.
Glacière. Polyester 600D/ PEVA.
Koelttas. Polyester 600D/ PEVA.

25 x 24 x 15 cm 20
Print Code: G(1), N(8)



19



02



01

Kardil 6285

Cool Bag. Polyester 600D/ PEVA.
Kühltasche. Polyester 600D/ PEVA.
Glacière. Polyester 600D/ PEVA.
Koelttas. Polyester 600D/ PEVA.

31 x 24,5 x 20 cm 30
Print Code: G(1), N(8)



03



04



19



19

Aitanax 6988

Cool Bag. Polyester 600D RPET/ Aluminium.
Kühltasche. Polyester 600D RPET/ Aluminium.
Glacière. Polyester 600D RPET/ Aluminium.
Koelttas. Polyester 600D RPET/ Aluminium.

26 x 20 x 8,5 cm 50
Print Code: G(1), N(8)



02



03



04



02

Listak 5593

Cool Bag. Polyester 210D/ PEVA.
Kühltasche. Polyester 210D/ PEVA.
Glacière. Polyester 210D/ PEVA.
Koelttas. Polyester 210D/ PEVA.

20 x 27 x 13 cm 50
Print Code: G(1), N(8)



04



19



03



03

Artirian 5298

Cool Bag. Polyester 210D/ PEVA.
Kühltasche. Polyester 210D/ PEVA.
Glacière. Polyester 210D/ PEVA.
Koelttas. Polyester 210D/ PEVA.

26 x 27 x 17,5 cm 50
Print Code: G(1), N(8)

19



04



01



07



Daniels 3311

Cool Bag. Polyester 190T/ Aluminium. Foldable.
 Kühltasche. Polyester 190T/ Aluminium. Faltbar.
 Glacière. Polyester 190T/ Aluminium. Pliable.
 Koeltas. Polyester 190T/ Aluminium. Opvouwbaar.

45 x 36 x 9 cm 100 / 20 Print Code: G(1)



Hobart 4690

Cool Bag. Laminated Non-Woven/ Aluminium.
 Kühltasche. Laminiertes Non-Woven/ Aluminium.
 Glacière. T.N.T. Laminé/ Aluminium.
 Koeltas. Gelamineerd Non-Woven/ Aluminium.

37 x 34 x 15 cm 200 / 50 Print Code: G(1)



Lans 5173

Cool Bag. Non-Woven/ Aluminium.
 Kühltasche. Non-Woven/ Aluminium.
 Glacière. T.N.T./ Aluminium.
 Koeltas. Non-Woven/ Aluminium.

27 x 31 x 15 cm 100 / 25 Print Code: G(1), N(8)



Pabbie 1248

Cool Bag. Laminated Non-Woven/ Aluminium.
 Kühltasche. Laminiertes Non-Woven/ Aluminium.
 Glacière. T.N.T. Laminé/ Aluminium.
 Koeltas. Gelamineerd Non-Woven/ Aluminium.

23 x 29 x 14 cm 100 / 50 Print Code: G(1)



Saimons 21048

Cool Bag. Polyester/ Aluminium.
 Kühltasche. Polyester/ Aluminium.
 Glacière. Polyester/ Aluminium.
 Koeltas. Polyester/ Aluminium.

23 x 29 x 14 cm 100 / 50 Print Code: G(1), N(8)



New



Sirkin 20620

Cool Bottle. 100% Recycled Cotton/ Aluminium.
 Flaschenkühltasche. 100% Recycling Baumwolle/ Aluminium.
 Glacière Bouteille. 100% Coton Recyclé/ Aluminium.
 Flessenkoeler. 100% Gerecycled Katoen/ Aluminium.

📏 Ø 11 x 35 cm 📦 100 / 20 ♻️ Print Code: G(1), N(8)

New



Tukam 1098

Cool Bottle. Polyester 300D RPET/ Aluminium.
 Flaschenkühltasche. Polyester 300D RPET/ Aluminium.
 Glacière Bouteille. Polyester 300D RPET/ Aluminium.
 Flessenkoeler. Polyester 300D RPET/ Aluminium.

📏 Ø 11 x 35 cm 📦 100 / 20 ♻️ Print Code: G(1), N(8)



Rafle 20621

Bottle Holder. Soft Shell.
 Flaschenhalter. Soft Shell.
 Porte-Bouteilles. Soft Shell.
 Flessenhouder. Soft Shell.

📏 Ø 8.5 x 23 cm 📦 100 / 25 ♻️ Print Code: G(1), N(8)



02

01

Sindy 6813

Cool Bag. Polyester 420D/ PEVA.
Kühltasche. Polyester 420D/ PEVA.
Glacière. Polyester 420D/ PEVA.
Koeltas. Polyester 420D/ PEVA.

37 x 29 x 21 cm

20

Print Code: G(1), N(8)



04

03

19

05

Gaslin 20622

Cool Bag Backpack. Polyester 600D RPET/ PEVA. Padded Back and Shoulder Straps.
Kühltasche Rucksack. Polyester 600D RPET/ PEVA. Gepolsterter Rücken und Schultergurte.
Sac à Dos Glacière. Polyester 600D RPET/ PEVA. Dos et Bretelles Rembourrées.
Koeltas-Rugzak. Polyester 600D RPET/ PEVA. Gewatteerde Achterzijde en Schouderbanden.

31.5 x 44 x 19 cm

10

Print Code: G(1), N(8)



New



Howar 6596

Cool Bag Backpack. Polyester 600D/ PEVA. Padded Shoulder Straps.
Kühltasche Rucksack. Polyester 600D/ PEVA. Gepolsterter Schultergurte.
Sac à Dos Glacière. Polyester 600D/ PEVA. Bretelles Rembourrées.
Koeltas-Rugzak. Polyester 600D/ PEVA. Gewatteerde Schouderbanden.

30 x 62 x 13 cm

20

Print Code: G(1), N(8)



Yamir 1734

Cool Bag Backpack. Polyester 600D RPET/ Aluminium. Padded Shoulder Straps.
Kühltasche Rucksack. Polyester 600D RPET/ Aluminium. Gepolsterter Schultergurte.

Sac à Dos Glacière. Polyester 600D RPET/ Aluminium. Bretelles Rembourrées.
Koeltas-Rugzak. Polyester 600D RPET/ Aluminium. Gewatteerde Schouderbanden.

31 x 40 x 18.5 cm

40

Print Code: G(1), N(8)



RPET

Cool Bag

BACKPACK



Polys 5419

Cool Bag Backpack. Polyester 600D/ Aluminium. Padded Shoulder Straps.
Kühltasche Rucksack. Polyester 600D/ Aluminium. Gepolsterte Schultergurte.
Sac à Dos Glacière. Polyester 600D/ Aluminium. Bretelles Rembourrées.
Koeltas-Rugzak. Polyester 600D/ Aluminium. Gewatteerde Schouderbanden.

31 x 40 x 18,5 cm 50 Print Code: G(1), N(8)

Nipex 5234

Drawstring Cool Bag. Polyester 210D/ Aluminium.
Kühltasche Rucksack. Polyester 210D/ Aluminium.
Sac à Dos Glacière. Polyester 210D/ Aluminium.
Koeltas-Rugzak. Polyester 210D/ Aluminium.

32 x 42 cm 200 / 10 Print Code: G(1)

Tradan 5235

Drawstring Cool Bag. Polyester 210D/ Aluminium.
Kühltasche Rucksack. Polyester 210D/ Aluminium.
Sac à Dos Glacière. Polyester 210D/ Aluminium.
Koeltas-Rugzak. Polyester 210D/ Aluminium.

27 x 33 cm 200 / 10
Print Code: G(1)



KIDS

11
01
02
03
04
05
07



New



04

Vortex 21177

Cool Bag. Polyester 210D/ Aluminium.
Kühltasche. Polyester 210D/ Aluminium.
Glacière. Polyester 210D/ Aluminium.
Koeltas. Polyester 210D/ Aluminium.

23 x 20.5 x 16 cm 100 / 25
Print Code: F(1)

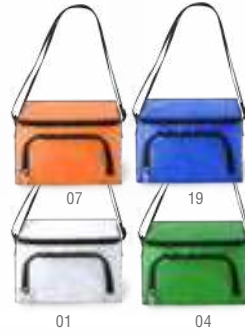

Radant 20623

Cool Bag. Polyester 210D/ Aluminium.
Kühltasche. Polyester 210D/ Aluminium.
Glacière. Polyester 210D/ Aluminium.
Koeltas. Polyester 210D/ Aluminium.

22 x 15 x 17.5 cm 100 / 20
Print Code: F(1), N(8)



New

03



03

04

Tivex 4147

Cool Bag. PVC/ Aluminium.
Kühltasche. PVC/ Aluminium.
Glacière. PVC/ Aluminium.
Koeltas. PVC/ Aluminium.

15 x 13 x 15 cm 200 / 25
Print Code: F(1), N(8)



01



Coolcan 3072

Cool Bag. PVC/ Aluminium.
Kühltasche. PVC/ Aluminium.
Glacière. PVC/ Aluminium.
Koeltas. PVC/ Aluminium.

21 x 15 x 15 cm 200 / 25
Print Code: F(1), N(8)



19

Hertum 5737

Cool Bag. Non-Woven/ Aluminium.
Kühltasche. Non-Woven/ Aluminium.
Glacière. T.N.T./ Aluminium.
Koeltas. Non-Woven/ Aluminium.

21 x 15 x 15 cm 200 / 25
Print Code: F(1), N(8)



09 BAGS





**REUSABLE,
FASHIONABLES,
MULTI-PURPOSES**

New

140 g/m²

Bestla 20770

Bag. 100% Recycled Cotton 140 g/ m².
Tasche. 100% Recycling Baumwolle 140 g/ m².
Sac. 100% Coton Recyclé 140 g/ m².
Tas. 100% Gerecycled Katoen 140 g/ m².

38 x 42 x 8 cm 100 / 20
Print Code: F(6), N(8), O, P

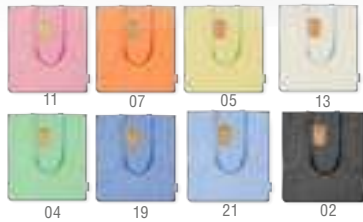

New

220 g/m²

Bonillo 20755

Bag. 100% Recycled Cotton 220 g/ m².
Tasche. 100% Recycling Baumwolle 220 g/ m².
Sac. 100% Coton Recyclé 220 g/ m².
Tas. 100% Gerecycled Katoen 220 g/ m².

50 x 36 x 12 cm 100 / 50
Print Code: F(6), N(8), O, P

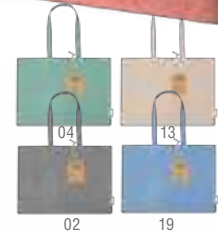

RECYCLED COTTON



New

240 g/m²

Framos 1816

Bag. 100% Recycled Cotton 240 g/ m².
Tasche. 100% Recycling Baumwolle 240 g/ m².
Sac. 100% Coton Recyclé 240 g/ m².
Tas. 100% Gerecycled Katoen 240 g/ m².

45 x 35 x 14 cm 100 / 10
Print Code: F(6), N(8), O, P



02

140 g/m²

Periad 1815

Bag. 100% Recycled Cotton 140 g/ m².
Tasche. 100% Recycling Baumwolle 140 g/ m².
Sac. 100% Coton Recyclé 140 g/ m².
Tas. 100% Gerecycled Katoen 140 g/ m².

50 x 38 x 15 cm 150 / 25
Print Code: F(6), N(8), O, P



04

19

NEW
COLOR300 g/m²

Yaponic 21134

Bag. 100% Recycled Cotton 300 g/ m².
Tasche. 100% Recycling Baumwolle 300 g/ m².
Sac. 100% Coton Recyclé 300 g/ m².
Tas. 100% Gerecycled Katoen 300 g/ m².

37 x 39 x 18 cm 50 / 10
Print Code: F(6), N(8), O, P

120 g/m²

Graket 6393

Bag. 100% Recycled Cotton 120 g/ m².
Tasche. 100% Recycling Baumwolle 120 g/ m².
Sac. 100% Coton Recyclé 120 g/ m².
Tas. 100% Gerecycled Katoen 120 g/ m².

 38 x 42 cm  250 / 50
 Print Code: F(6), N(8), O, P



140 g/m²

Rassel 1176

Bag. 100% Recycled Cotton 140 g/ m².
Tasche. 100% Recycling Baumwolle 140 g/ m².
Sac. 100% Coton Recyclé 140 g/ m².
Tas. 100% Gerecycled Katoen 140 g/ m².

 38 x 42 cm  250 / 50
 Print Code: F(6), N(8), O, P



NEW COLOR



120 g/m²

Biyon 1814

Foldable Bag. 100% Recycled Cotton 120 g/ m².
Faltbare Tasche. 100% Recycling Baumwolle 120 g/ m².
Sac Pliable. 100% Coton Recyclé 120 g/ m².
Opvouwbare Tas. 100% Gerecycled Katoen 120 g/ m².



 38 x 40 cm  200 / 10
 Print Code: F(6), N(8), O, P



140 g/m²

Fenin 6833

Drawstring Bag. 100% Recycled Cotton 140 g/ m².
Rucksack Tasche. 100% Recycling Baumwolle 140 g/ m².
Sac à Dos. 100% Coton Recyclé 140 g/ m².
Ruzsak Tas. 100% Gerecycled Katoen 140 g/ m².

 38 x 42 cm  100 / 50
 Print Code: F(6), N(8), O, P



NEW COLOR



DRAWSTRING BAG

New

140 g/m²

Talara 20774

02

Bag. 100% Recycled Cotton 140 g/ m²/ Jute.
 Tasche. 100% Recycling Baumwolle 140 g/ m²/ Jutestoff.
 Sac. 100% Coton Recyclé 140 g/ m²/ Jute.
 Tas. 100% Gerecycled Katoen 140 g/ m²/ Jutestoff.

36 x 45 x 11 cm 100 / 25
 Print Code: F(6), N(8), O, P



03

04

13

19



RECYCLED & COTTON JUTE

120 g/m²

Skadi 20771

Bag. 100% Recycled Cotton 120 g/ m².
 Tasche. 100% Recycling Baumwolle 120 g/ m².
 Sac. 100% Coton Recyclé 120 g/ m².
 Tas. 100% Gerecycled Katoen 120 g/ m².

38 x 42 cm 200 / 20 Print Code: F(6), N(8), O, P



19

03

13

02



04



04

13

03

02

Kauna 20772

120 g/m²

Bag. 100% Recycled Cotton 120 g/ m².
 Tasche. 100% Recycling Baumwolle 120 g/ m².
 Sac. 100% Coton Recyclé 120 g/ m².
 Tas. 100% Gerecycled Katoen 120 g/ m².

38 x 42 x 8 cm 100 / 20 Print Code: F(6), N(8), O, P

19

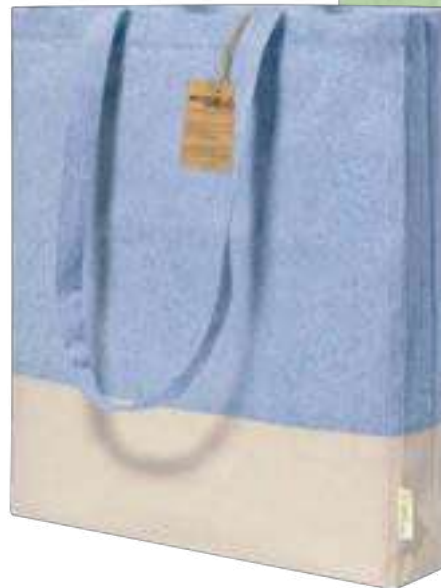



New

04

230 g/m²

Krinix 21132

Bag. Canvas 230 g/ m².
Tasche. Canvas 230 g/ m².
Sac. Tolle 230 g/ m².
Tas. Canvas 230 g/ m².

34 x 40 cm 200 / 50 Print Code: F(6), N(8), O, P



New

06

280 g/m²

Dretan 20757

Bag. 100% Cotton 280 g/ m².
Tasche. 100% Baumwolle 280 g/ m².
Sac. 100% Coton 280 g/ m².
Tas. 100% Katoen 280 g/ m².

53 x 38 x 17 cm 100 / 50
Print Code: F(6), N(8), O, P



02

03



New

Sakura 20781

Bag. Canvas 270 g/ m².
Tasche. Canvas 270 g/ m².
Sac. Tolle 270 g/ m².
Tas. Canvas 270 g/ m².

38 x 42 x 9 cm 100 / 50 Print Code: F(6), N(8), O, P

270 g/m²

Trokal 1822

Bag. 100% Cotton 310 g/ m².
Tasche. 100% Baumwolle 310 g/ m².
Sac. 100% Coton 310 g/ m².
Tas. 100% Katoen 310 g/ m².

33 x 40 x 7.5 cm 50 / 5 Print Code: F(6), N(8), O, P

310 g/m²

Sembak 1823

Bag. 100% Cotton 310 g/ m².
Tasche. 100% Baumwolle 310 g/ m².
Sac. 100% Coton 310 g/ m².
Tas. 100% Katoen 310 g/ m².

38 x 38 x 12 cm 50 / 5 Print Code: F(6), N(8), O, P

310 g/m²

Walvix 1821

Bag. 100% Cotton 310 g/ m².
Tasche. 100% Baumwolle 310 g/ m².
Sac. 100% Coton 310 g/ m².
Tas. 100% Katoen 310 g/ m².

36 x 42 x 20.5 cm 50 / 5 Print Code: F(6), N(8), O, P

310 g/m²



ORGANIC COTTON



Klimbou 1175

140 g/m²

Bag. 100% Organic Cotton 140 g/ m2.
Tasche. 100% Organische Baumwolle 140 g/ m2.
Sac. 100% Coton Organique 140 g/ m2.
Tas. 100% Organisch Katoen 140 g/ m2.

38 x 42 cm 200 / 50 Print Code: F(6), M, N(8), O, P

06

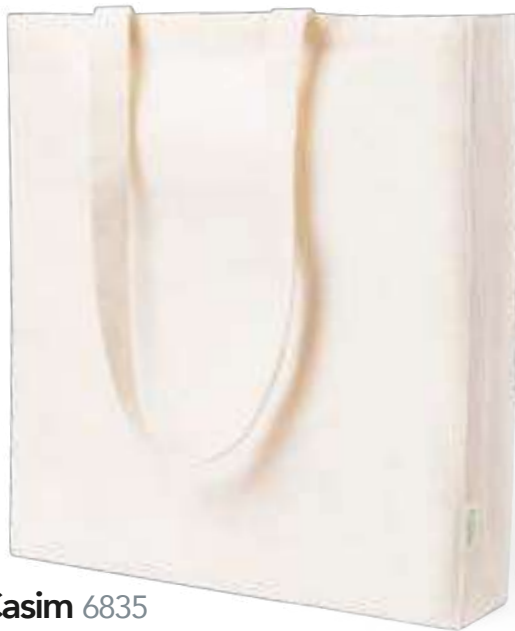

Casim 6835

Bag. 100% Organic Cotton 140 g/ m2.
Tasche. 100% Organische Baumwolle 140 g/ m2.
Sac. 100% Coton Organique 140 g/ m2.
Tas. 100% Organisch Katoen 140 g/ m2.

38 x 42 x 8 cm 150 / 50 Print Code: F(6), N(8), O, P

140 g/m²

Nepax 6391

Foldable Bag. 100% Organic Cotton 120 g/ m2.
Faltbare Tasche. 100% Organische Baumwolle 120 g/ m2.
Sac Pliable. 100% Coton Organique 120 g/ m2.
Opvouwbare Tas. 100% Organisch Katoen 120 g/ m2.

120 g/m²

38 x 42 cm 200 / 10 Print Code: F(6), G(6), N(6)





ORGANIC
COTTON



Fizzy 1174

180 g/m²

Bag. 100% Organic Cotton 180 g/ m².
Tasche. 100% Organische Baumwolle 180 g/ m².
Sac. 100% Coton Organique 180 g/ m².
Tas. 100% Organisch Katoen 180 g/ m².

38 x 42 cm 150 / 50 Print Code: F(6), N(8), O, P

Rumel 1173

140 g/m²

Bag. 100% Organic Cotton 140 g/ m².
Tasche. 100% Organische Baumwolle 140 g/ m².
Sac. 100% Coton Organique 140 g/ m².
Tas. 100% Organisch Katoen 140 g/ m².

38 x 42 cm 200 / 50 Print Code: F(6), N(8), O, P

Missam 6389

120 g/m²

Bag. 100% Organic Cotton 120 g/ m².
Tasche. 100% Organische Baumwolle 120 g/ m².
Sac. 100% Coton Organique 120 g/ m².
Tas. 100% Organisch Katoen 120 g/ m².

38 x 42 cm 250 / 50 Print Code: F(6), N(8), O, P



Flyca Fairtrade 1265

Bag. 100% Cotton 180 g/ m2.
Tasche. 100% Baumwolle 180 g/ m2.
Sac. 100% Coton 180 g/ m2.
Tas. 100% Katoen 180 g/ m2.

180 g/m²

37 x 41 cm 150 / 50 Print Code: F(6), N(8), O, P



Elatek Fairtrade 1266

Bag. 100% Cotton 180 g/ m2.
Tasche. 100% Baumwolle 180 g/ m2.
Sac. 100% Coton 180 g/ m2.
Tas. 100% Katoen 180 g/ m2.

180 g/m²

38 x 42 x 12 cm 150 / 50
Print Code: F(6), N(8), O, P



The Fairtrade Cotton label guarantees that the product comes from a traceable and sustainable sourcing chain and helps us to identify garments where 100% of the composition is traceable Fairtrade cotton. All of the cotton is Fairtrade certified, traded, audited and sourced from Fairtrade producers. Visit www.info.fairtrade.net

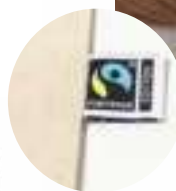

New

280 g/m²

Hexa Fairtrade 20780

Bag. 100% Cotton 280 g/m2.
Tasche. 100% Baumwolle 280 g/m2.
Sac. 100% Coton 280 g/m2.
Tas. 100% Katoen 280 g/m2.

45 x 38 x 10,5 cm 50
Print Code: F(6), N(8), O, P



02

140 g/m²

Annet Fairtrade 1753

Bag. 100% Cotton 140 g/ m2.
Tasche. 100% Baumwolle 140 g/ m2.
Sac. 100% Coton 140 g/ m2.
Tas. 100% Katoen 140 g/ m2.

37 x 41 cm 150 / 50
Print Code: F(6), N(8), O, P





The Fairtrade Cotton label guarantees that the product comes from a traceable and sustainable sourcing chain and helps us to identify garments where 100% of the composition is traceable Fairtrade cotton. All of the cotton is Fairtrade certified, traded, audited and sourced from Fairtrade producers. Visit www.info.fairtrade.net



03



140 g/m²

Riak Fairtrade 20776

Drawstring Bag. 100% Recycled Cotton 140 g/ m2.
 Rucksack Tasche. 100% Recycling Baumwolle 140 g/ m2.
 Sac à Dos. 100% Coton Recyclé 140 g/ m2.
 Ruzgak Tas. 100% Gerecycled Katoen 140 g/ m2.

38 x 42 cm 100 / 50 Print Code: F(6), N(8), O, P



19

120 g/m²

Lazar Fairtrade 20777

Bag. 100% Recycled Cotton 120 g/ m2.
 Tasche. 100% Recycling Baumwolle 120 g/ m2.
 Sac. 100% Coton Recyclé 120 g/ m2.
 Tas. 100% Gerecycled Katoen 120 g/ m2.

38 x 42 cm 150 / 50
 Print Code: F(6), N(8), O, P

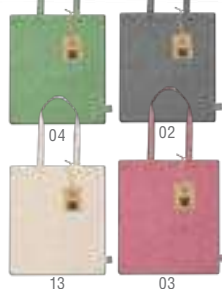

13

03

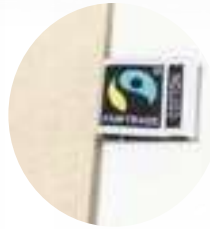

New

180 g/m²

Inova Fairtrade 20775

Bag. 100% Cotton 180 g/ m2.
 Tasche. 100% Baumwolle 180 g/ m2.
 Sac. 100% Coton 180 g/ m2.
 Tas. 100% Katoen 180 g/ m2.

38 x 42 cm 150 / 50
 Print Code: F(6), N(8), O, P



01

03

06

100% Cotton

Larsen 3322



Larsen 3322

105 g/m²

Bag. 100% Cotton 105 g/ m2.
Tasche. 100% Baumwolle 105 g/ m2.
Sac. 100% Coton 105 g/ m2.
Tas. 100% Katoen 105 g/ m2.

📏 37 x 41 cm 📦 250 / 50 🖨️ Print Code: F(6), N(8), O, P

Siltex 6048

140 g/m²

Bag. 100% Cotton 140 g/ m2.
Tasche. 100% Baumwolle 140 g/ m2.
Sac. 100% Coton 140 g/ m2.
Tas. 100% Katoen 140 g/ m2.

📏 37 x 41 cm 📦 250 / 50 🖨️ Print Code: F(6), N(8), O, P

Ponkal 6049

180 g/m²

Bag. 100% Cotton 180 g/ m2.
Tasche. 100% Baumwolle 180 g/ m2.
Sac. 100% Coton 180 g/ m2.
Tas. 100% Katoen 180 g/ m2.

📏 37 x 41 cm 📦 150 / 50 🖨️ Print Code: F(6), N(8), O, P

Chidel 1817



100% Cotton

**Trendik 1172**240 g/m²

Bag. 100% Cotton 240 g/ m2.
 Tasche. 100% Baumwolle 240 g/ m2.
 Sac. 100% Coton 240 g/ m2.
 Tas. 100% Katoen 240 g/ m2.

📏 37 x 41 cm 📦 100 / 50 🔄 Print Code: F(6), N(8), O, P

**Chidel 1817**280 g/m²

Bag. 100% Cotton 280 g/ m2.
 Tasche. 100% Baumwolle 280 g/ m2.
 Sac. 100% Coton 280 g/ m2.
 Tas. 100% Katoen 280 g/ m2.

📏 37 x 41 cm 📦 80 / 20 🔄 Print Code: F(6), N(8), O, P

**Emphy 1818**300 g/m²

Bag. 100% Cotton 300 g/ m2.
 Tasche. 100% Baumwolle 300 g/ m2.
 Sac. 100% Coton 300 g/ m2.
 Tas. 100% Katoen 300 g/ m2.

📏 37 x 41 cm 📦 80 / 20 🔄 Print Code: F(6), N(8), O, P



SPECIAL CONGRESS

Congres 1834

120 g/m²

Bag. 100% Cotton 120 g/ m2.
Tasche. 100% Baumwolle 120 g/ m2.
Sac. 100% Coton 120 g/ m2.
Tas. 100% Katoen 120 g/ m2.

25 x 30 cm 300 / 50 Print Code: F(6), N(8), O, P



03



Fuzox 4621

105 g/m²

Bag. 100% Cotton 105 g/ m2.
Tasche. 100% Baumwolle 105 g/ m2.
Sac. 100% Coton 105 g/ m2.
Tas. 100% Katoen 105 g/ m2.

37 x 41 cm 250 / 50
 Print Code: F(6), N(8), O, P

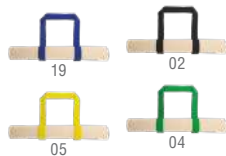

Daytona 3321

105 g/m²

Bag. 100% Cotton 105 g/ m2.
Tasche. 100% Baumwolle 105 g/ m2.
Sac. 100% Coton 105 g/ m2.
Tas. 100% Katoen 105 g/ m2.

37 x 41 cm 250 / 50 Print Code: F(6), N(8), O, P

Welrop 5738

105 g/m²

Bag. 100% Cotton 105 g/ m2.
Tasche. 100% Baumwolle 105 g/ m2.
Sac. 100% Coton 105 g/ m2.
Tas. 100% Katoen 105 g/ m2.

41.5 x 37 x 7 cm 200 / 10 Print Code: F(6), N(8), O, P

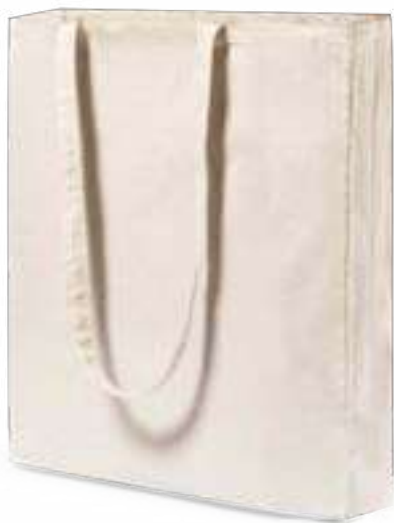

Dongay 1824

140 g/m²

Bag. 100% Cotten 140 g/ m2.
Tasche. 100% Baumwolle 140 g/ m2.
Sac. 100% Coton 140 g/ m2.
Tas. 100% Katoen 140 g/ m2.

35 x 40 x 11 cm 100 / 10 Print Code: F(6), N(8), O, P



Bidal 1941

220 g/m²

Bag. 100% Cotten 220 g/ m2.
Tasche. 100% Baumwolle 220 g/ m2.
Sac. 100% Coton 220 g/ m2.
Tas. 100% Katoen 220 g/ m2.

38 x 41 x 8.5 cm 100 / 10 Print Code: F(6), N(8), O, P



Helfy 6836

140 g/m²

Bag. 100% Cotten 140 g/ m2.
Tasche. 100% Baumwolle 140 g/ m2.
Sac. 100% Coton 140 g/ m2.
Tas. 100% Katoen 140 g/ m2.

45 x 38 x 11 cm 100 / 10 Print Code: F(6), N(8), O, P



01

Coina 5452

Bag. 100% Cotton 105 g/ m2.
Tasche. 100% Baumwolle 105 g/ m2.
Sac. 100% Coton 105 g/ m2.
Tas. 100% Katoen 105 g/ m2.

36 x 36 x 8 cm 200 / 50 Print Code: F(6), M, N(8), O, P

105 g/m²

Lakous 5451

105 g/m²

Bag. 100% Cotton 105 g/ m2.
Tasche. 100% Baumwolle 105 g/ m2.
Sac. 100% Coton 105 g/ m2.
Tas. 100% Katoen 105 g/ m2.

37 x 41 x 8 cm 200 / 50
 Print Code: F(6), N(8), O, P



Helakel 6118

105 g/m²

Foldable Bag. 100% Cotton 105 g/ m2.
Faltbare Tasche. 100% Baumwolle 105 g/ m2.
Sac Pliable. 100% Coton 105 g/ m2.
Opvouwbare Tas. 100% Katoen 105 g/ m2.

37 x 41 cm 200 / 10
 Print Code: F(6), G(6), N(8), P



BAGS



Geiser 3210

105 g/m²

Bag. 100% Cotton 105 g/ m².
Tasche. 100% Baumwolle 105 g/ m².
Sac. 100% Coton 105 g/ m².
Tas. 100% Katoen 105 g/ m².

36 x 40 cm 250 / 50
Print Code: F(6), M, N(8), O, P



Turkal 6050

140 g/m²

Bag. 100% Cotton 140 g/ m².
Tasche. 100% Baumwolle 140 g/ m².
Sac. 100% Coton 140 g/ m².
Tas. 100% Katoen 140 g/ m².

36 x 40 cm 250 / 50
Print Code: F(6), M, N(8), O, P



Xental 1820

240 g/m²

Bag. 100% Cotton 240 g/ m².
Tasche. 100% Baumwolle 240 g/ m².
Sac. 100% Coton 240 g/ m².
Tas. 100% Katoen 240 g/ m².

36 x 40 cm 100 / 20
Print Code: F(6), M, N(8), O, P



Kaiba 1819

180 g/m²

Bag. 100% Cotton 180 g/ m².
Tasche. 100% Baumwolle 180 g/ m².
Sac. 100% Coton 180 g/ m².
Tas. 100% Katoen 180 g/ m².

36 x 40 cm 150 / 50
Print Code: F(6), M, N(8), O, P



JUTE & COTTON



Lerkal 5983

120 g/m²

Bag. 100% Cotton 120 g/ m²/ Jute.
Tasche. 100% Baumwolle 120 g/ m²/ Jutestoff.
Sac. 100% Coton 120 g/ m²/ Jute.
Tas. 100% Katoen 120 g/ m²/ Jutestoff.

37 × 41 cm 200 / 10
Print Code: F(6), N(8), O, P



Suelva 20909

120 g/m²

Bag. 100% Cotton 120 g/ m²/ Jute.
Tasche. 100% Baumwolle 120 g/ m²/ Jutestoff.
Sac. 100% Coton 120 g/ m²/ Jute.
Tas. 100% Katoen 120 g/ m²/ Jutestoff.

38 × 42 cm 200 / 10
Print Code: F(6), N(8), O, P



Gaviar 21130

270 g/m²

Bag. Polyester 260 g/ m².
Tasche. Polyester 260 g/ m².
Sac. Polyester 260 g/ m².
Tas. Polyester 260 g/ m².

36 × 38 × 10 cm 100 / 10
Print Code: N(8), P



BAGS

Rotin 6387

Bag. Laminated Jute/ Laminated Cotton.
Tasche. Laminiertes Jutestoff/ Laminiertes Baumwolle.
Sac. Jute Laminé/ Coton Laminé.
Tas. Gelamineerd Jute/ Gelamineerd Katoen.

39 × 31.5 × 16 cm 50 / 10
Print Code: F(6), N(8)

110 g/m²

Dylan 6727

Foldable Bag. 100% Cotton 110 g/ m²/ Jute.
Faltbare Tasche. 100% Baumwolle 110 g/ m²/ Jutestoff.
Sac Pliable. 100% Coton 110 g/ m²/ Jute.
Opvouwbare Tas. 100% Katoen 110 g/ m²/ Jutestoff.

34.5 × 39 × 10 cm 100 / 10
Print Code: G(6), H(6), N(8)



Rotin 6387

Dylan 6727

13

04

06

05

Natural Cork & COTTON



New

Lyrixon 21136

Bag. Cork.
Tasche. Kork.
Sac. Liège.
Tas. Kurk.

35 x 40 cm 200 / 50 Print Code: F(1), N(8)



Yulia 6829

180 g/m²

Bag. 100% Cotton 180 g/ m2/ Cork.
Tasche. 100% Baumwolle 180 g/ m2/ Kork.
Sac. 100% Coton 180 g/ m2/ Liège.
Tas. 100% Katoen 180 g/ m2/ Kurk.

37 x 41 cm 100 / 10 Print Code: F(6), N(8), O, P



Tarlam 5831

145 g/m²

Bag. 100% Cotton 145 g/ m2/ Cork.
Tasche. 100% Baumwolle 145 g/ m2/ Kork.
Sac. 100% Coton 145 g/ m2/ Liège.
Tas. 100% Katoen 145 g/ m2/ Kurk.

35 x 40 cm 100 / 10 Print Code: F(6), N(8), O, P



Charel 6726

Tuarey 6830

180 g/m²

Bag. 100% Cotton 180 g/ m2/ Cork.
Tasche. 100% Baumwolle 180 g/ m2/ Kork.
Sac. 100% Coton 180 g/ m2/ Liège.
Tas. 100% Katoen 180 g/ m2/ Kurk.

45 x 40 x 9 cm 100 / 10 Print Code: F(6), N(8), O, P



Charel 6726

Foldable Bag. 100% Cotton 110 g/ m2/ Cork.
Faltbare Tasche. 100% Baumwolle 110 g/ m2/ Kork.
Sac Pliable. 100% Coton 110 g/ m2/ Liège.
Opvouwbare Tas. 100% Katoen 110 g/ m2/ Kurk.

34.5 x 39 x 10 cm 100 / 10 Print Code: G(6), N(8), H(6)

110 g/m²



ONE FLAT SIDE
FOR PRINTING

Tolmen 6625

Bag. 100% Cotton 120 g/ m².
Tasche. 100% Baumwolle 120 g/ m².
Sac. 100% Coton 120 g/ m².
Tas. 100% Katoen 120 g/ m².

120 g/m²

25 x 30 cm 250 / 50 Print Code: F(6), N(8), P

Nacry 6577

Foldable Bag. 100% Cotton.
Faltbare Tasche. 100% Baumwolle.
Sac Pliable. 100% Coton.
Opvouwbare Tas. 100% Katoen.

44 x 33 cm 200 / 10
Print Code: F(6), N(8)



Trobax 6572

220 g/m²

Bag. 100% Cotton 220 g/ m².
Tasche. 100% Baumwolle 220 g/ m².
Sac. 100% Coton 220 g/ m².
Tas. 100% Katoen 220 g/ m².

41 x 45 cm 100 / 10 Print Code: F(6), N(8), P



20

04

18



ZIPPER

02



02

01

07

19

03

Shop 6106

Bag. Non-Woven.
Tasche. Non-Woven.
Sac. T.N.T..
Tas. Non-Woven.

33 x 38 x 25 cm 200 / 10
Print Code: F(1)



04

Bread 9728

Bag. 100% Cotton 105 g/ m².
Tasche. 100% Baumwolle 105 g/ m².
Sac. 100% Coton 105 g/ m².
Tas. 100% Katoen 105 g/ m².

20 x 58 cm 500 / 10
Print Code: F(1), N(8), O, P



RECYCLED PAPER

140 g/m²**Kolsar 6175**

Bag. Recycled Paper 140 g/ m².
Tasche. Recycling Papier 140 g/ m².
Sac. Papier Recyclé 140 g/ m².
Tas. Gerecycled Papier 140 g/ m².

40 x 30.5 x 15.5 cm 100 / 10 Print Code: F(1)

105 g/m²**Curiel 6821**

Bag. Laminated Recycled Paper 105 g/ m²/ Cotton.
Tasche. Laminiertes Recycling Papier 105 g/ m²/ Baumwolle.
Sac. Papier Recyclé Laminé 105 g/ m²/ Coton.
Tas. Gelamineerd Gerecycled Papier 105 g/ m²/ Katoen.

37 x 41 cm 100 / 10 Print Code: F(1)



01

Kiarax 6767

Antibacterial Bag. Laminated Non-Woven.
Antibakteriell Tasche. Laminiertes Non-Woven.
Sac Antibacterienne. T.N.T. Laminé.
Antibacterieel Tas. Gelamineerd Non-Woven.

38 x 40 x 12 cm 200 / 10
 Print Code: F(1)

02



03



19

**Maxcron 2607**

Antibacterial Bag. Polyester.
Antibakteriell Tasche. Polyester.
Sac Antibacterienne. Polyester.
Antibacterieel Tas. Polyester.

37 x 41 cm 300 / 10
 Print Code: F(1), N(8), R



ANTIBACTERIAL AND WATER
RESISTANT FABRIC

PLA

**Moltux 6438**

Bag. PLA 100% Compostable.
Tasche. PLA 100% Kompostierbar.
Sac. PLA 100% Compostable.
Tas. PLA 100% Composteerbaar.

36 x 40 cm 200 / 50 Print Code: F(1)



FELT RPET



Biggy 1250

Bag, Felt RPET.
Tasche, Filz RPET.
Sac, Feutrine RPET.
Tas. Vilt RPET.

40 x 42 x 15 cm 50 / 5 Print Code: F(1), N(8)



Flavux 1249

Bag, Felt RPET.
Tasche, Filz RPET.
Sac, Feutrine RPET.
Tas. Vilt RPET.

42 x 31 x 11.5 cm 50 / 5 Print Code: F(1), N(8)



Kompul 1813

Bag, Felt RPET/ PU.
Tasche, Filz RPET/ PU.
Sac, Feutrine RPET/ Similicuir.
Tas. Vilt RPET/ PU.

42 x 30 x 10 cm 50 Print Code: F(1), N(8)



Kalkut 5808

Bag. Jute/ Cotton.
Tasche. Jutestoff/ Baumwolle.
Sac. Jute/ Coton.
Tas. Jute/ Katoen.

38 x 41 cm 100 / 10
 Print Code: F(1), N(8)



13



Brios 1166

Bag. Jute/ Cotton.
Tasche. Jutestoff/ Baumwolle.
Sac. Jute/ Coton.
Tas. Jute/ Katoen.

38 x 42 cm 100 / 20
 Print Code: F(1), N(8)



04



13

Dhar 3047

Bag. Jute/ Cotton.
Tasche. Jutestoff/ Baumwolle.
Sac. Jute/ Coton.
Tas. Jute/ Katoen.

38 x 42 cm 100 / 20
 Print Code: F(1), N(8)



04



Flobux 1165

Bag. Jute/ Cotton.
Tasche. Jutestoff/ Baumwolle.
Sac. Jute/ Coton.
Tas. Jute/ Katoen.

38 x 42 cm 100 / 20 Print Code: F(1), N(8)



13

Misix 1153

Bag. 100% Hemp Fabric 200 g/ m2.
Tasche. 100% Hanf-Stoff 200 g/ m2.
Sac. 100% Tissu de Chanvre 200 g/ m2.
Tas. 100% Hennep Stof 200 g/ m2.

37 x 41 cm 150 / 50
 Print Code: F(1), N(8)



04

NEW
COLOR

Cekon 5725

Bag. Laminated Jute/ Cotton.
Tasche. Laminiertes Jutestoff/ Baumwolle.
Sac. Jute Laminé/ Coton.
Tas. Gelamineerd Jute/ Katoen.

44.5 x 34 x 15 cm 50 / 10
Print Code: F(6), N(8)



JUTE & COTTON

417

BAGS

Solux 5736

Bag. Laminated Jute/ Cotton.
Tasche. Laminiertes Jutestoff/ Baumwolle.
Sac. Jute Laminé/ Coton.
Tas. Gelamineerd Jute/ Katoen.

38 x 42 x 16 cm 50 / 10
Print Code: F(1), N(8)



Solux 5736

13

Cekon 5725



13



Hintol 4883

Bag. Laminated Jute/ Cotton.
Tasche. Laminiertes Jutestoff/ Baumwolle.
Sac. Jute Laminé/ Coton.
Tas. Gelamineerd Jute/ Katoen.

44.5 x 35 x 14 cm 60 / 5
Print Code: F(1), N(8)



Triex 6820

Bag. Laminated Jute/ Cotton.
Tasche. Laminiertes Jutestoff/ Baumwolle.
Sac. Jute Laminé/ Coton.
Tas. Gelamineerd Jute/ Katoen.

44.5 x 35 x 14 cm 50 / 10
Print Code: F(1), N(8)

Farus 5726

Bag. Jute/ Cotton.
Tasche. Jutestoff/ Baumwolle.
Sac. Jute/ Coton.
Tas. Jute/ Katoen.

48 x 35 x 15 cm 100 / 10
Print Code: F(6), N(8)



04

Falyan 20773

Drawstring Bag, Polyester RPET.
Rucksack Tasche, Polyester RPET.
Sac à Dos, Polyester RPET.
Rugzak Tas, Polyester RPET.

34 x 42 cm 300 / 50
Print Code: F(1), N(8), R



SUBLIMATION

SUBLIMATION

SUBLIMATION

SUBLIMATION

SUBLIMATION

SUBLIMATION

SUBLIMATION

SUBLIMATION

SUBLIMATION

SUBLIMATION

SUBLIMATION

SUBLIMATION

SUBLIMATION

SUBLIMATION

SUBLIMATION

SUBLIMATION

SUBLIMATION

SUBLIMATION

SUBLIMATION

SUBLIMATION

SUBLIMATION

SUBLIMATION

SUBLIMATION

SUBLIMATION

SUBLIMATION

SUBLIMATION

SUBLIMATION

SUBLIMATION

SUBLIMATION

SUBLIMATION

SUBLIMATION

SUBLIMATION

SUBLIMATION

SUBLIMATION

SUBLIMATION

SUBLIMATION

SUBLIMATION

SUBLIMATION

SUBLIMATION

SUBLIMATION

SUBLIMATION

SUBLIMATION

SUBLIMATION

SUBLIMATION

SUBLIMATION

SUBLIMATION

SUBLIMATION

SUBLIMATION

SUBLIMATION

SUBLIMATION

SUBLIMATION

SUBLIMATION

SUBLIMATION

SUBLIMATION

SUBLIMATION

SUBLIMATION

SUBLIMATION

SUBLIMATION

SUBLIMATION

SUBLIMATION

SUBLIMATION

SUBLIMATION

SUBLIMATION

SUBLIMATION

SUBLIMATION

SUBLIMATION

SUBLIMATION

SUBLIMATION

SUBLIMATION

SUBLIMATION

SUBLIMATION

SUBLIMATION

SUBLIMATION

SUBLIMATION

SUBLIMATION

SUBLIMATION

SUBLIMATION

SUBLIMATION

SUBLIMATION

SUBLIMATION

SUBLIMATION

SUBLIMATION

SUBLIMATION

SUBLIMATION

SUBLIMATION

SUBLIMATION

SUBLIMATION

SUBLIMATION

SUBLIMATION

SUBLIMATION

SUBLIMATION

SUBLIMATION

SUBLIMATION

SUBLIMATION

SUBLIMATION

SUBLIMATION

SUBLIMATION

SUBLIMATION

SUBLIMATION

SUBLIMATION

SUBLIMATION

SUBLIMATION

SUBLIMATION

SUBLIMATION

SUBLIMATION

SUBLIMATION

SUBLIMATION

SUBLIMATION

SUBLIMATION

SUBLIMATION

SUBLIMATION

SUBLIMATION

SUBLIMATION

SUBLIMATION

SUBLIMATION

SUBLIMATION

SUBLIMATION

SUBLIMATION

SUBLIMATION

SUBLIMATION

SUBLIMATION

SUBLIMATION

SUBLIMATION

SUBLIMATION

SUBLIMATION

SUBLIMATION

SUBLIMATION

SUBLIMATION

SUBLIMATION

SUBLIMATION

SUBLIMATION

SUBLIMATION

SUBLIMATION

SUBLIMATION

SUBLIMATION

SUBLIMATION

SUBLIMATION

SUBLIMATION

SUBLIMATION

SUBLIMATION

SUBLIMATION

SUBLIMATION

SUBLIMATION

SUBLIMATION

SUBLIMATION

SUBLIMATION

SUBLIMATION

SUBLIMATION

SUBLIMATION

SUBLIMATION

SUBLIMATION

SUBLIMATION

SUBLIMATION

SUBLIMATION

SUBLIMATION

SUBLIMATION

SUBLIMATION

SUBLIMATION

SUBLIMATION

SUBLIMATION

SUBLIMATION

SUBLIMATION

SUBLIMATION

SUBLIMATION

SUBLIMATION

SUBLIMATION

RPET



04

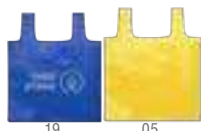

19

05



01

02



03



07

06

05



01

02

04

03



19

Restun 6422

Foldable Bag, Polyester RPET.
Faltbare Tasche, Polyester RPET.
Sac Pliable, Polyester RPET.
Opvouwbare Tas, Polyester RPET.

45 x 38.5 cm 400 / 20
Print Code: F(1), G(1), R



FOLDABLE



SUBLIMATION

SUBLIMATION

SUBLIMATION

SUBLIMATION

SUBLIMATION

SUBLIMATION

SUBLIMATION

SUBLIMATION

SUBLIMATION

SUBLIMATION

SUBLIMATION

SUBLIMATION

SUBLIMATION

SUBLIMATION

SUBLIMATION

SUBLIMATION

SUBLIMATION

SUBLIMATION

SUBLIMATION

SUBLIMATION

SUBLIMATION

SUBLIMATION

SUBLIMATION

SUBLIMATION

SUBLIMATION

Lulu 1825

Foldable Bag, Polyester RPET.
Faltbare Tasche, Polyester RPET.
Sac Pliable, Polyester RPET.
Opvouwbare Tas, Polyester RPET.

38 x 42 cm 400 / 20
Print Code: F(1), G(1), R

FOLDABLE

Okada 1826

Bag. Laminated Polyester RPET.
Tasche. Laminiertes Polyester RPET.
Sac. Polyester RPET Laminé.
Tas. Gelamineerd Polyester RPET.

35 x 40 x 15 cm 200 / 10 Print Code: F(1)



Okada 1826



Kaiso 6341

Bag. Laminated Polyester RPET.
Tasche. Laminiertes Polyester RPET.
Sac. Polyester RPET Laminé.
Tas. Gelamineerd Polyester RPET.

42 x 35 x 15 cm 200 / 10 Print Code: F(1)

Kaiso 6341



Recycle 9771

Bag. Biodegradable.
Tasche. Kompostierbar.
Sac. Biodégradable.
Tas. Biologisch Afbreekbaar.

38 x 38 x 12.5 cm 100 / 20 Print Code: F(1)



RPET



Frilend 6340

Bag. Laminated Polyester RPET.
Tasche. Laminiertes Polyester RPET.
Sac. Polyester RPET Laminé.
Tas. Gelamineerd Polyester RPET.

37 x 41 cm 250 / 10 Print Code: F(1)



02



RPET
Non-Woven



18



06



01

Mariek 1827

Bag, Non-Woven RPET.
Tasche, Non-Woven RPET.
Sac. T.N.T. RPET.
Tas. Non-Woven RPET.



06 02 01

36 x 40 cm 250 / 25 Print Code: F(1)

Raduin 1829

Bag, Non-Woven RPET.
Tasche, Non-Woven RPET.
Sac. T.N.T. RPET.
Tas. Non-Woven RPET.



02 18 01

38 x 35 cm 250 / 50 Print Code: F(1)

Dromeda 1828

Bag, Non-Woven RPET.
Tasche, Non-Woven RPET.
Sac. T.N.T. RPET.
Tas. Non-Woven RPET.

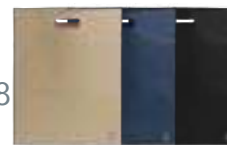

18 06 02

34 x 43 cm 400 / 20 Print Code: F(1)

Foldable Bag



Karent 6123

Foldable Bag, Polyester 190T.
 Faltbare Tasche, Polyester 190T.
 Sac Pliable, Polyester 190T.
 Opvouwbare Tas, Polyester 190T.

46 x 33 x 8 cm 400 / 20
 Print Code: F(1), G(1), R



Dayfan 6122

Foldable Bag, Polyester 190T.
 Faltbare Tasche, Polyester 190T.
 Sac Pliable, Polyester 190T.
 Opvouwbare Tas, Polyester 190T.

40 x 38 cm 400 / 20
 Print Code: F(1), G(1), R



Corni 3365

Foldable Bag, Polyester 190T.
 Faltbare Tasche, Polyester 190T.
 Sac Pliable, Polyester 190T.
 Opvouwbare Tas, Polyester 190T.

40 x 38 cm 400 / 10
 Print Code: F(1), G(1)



Conel 4781

Foldable Bag, Polyester 190T.
 Faltbare Tasche, Polyester 190T.
 Sac Pliable, Polyester 190T.
 Opvouwbare Tas, Polyester 190T.

38 x 41 cm 400 / 20
 Print Code: F(1), G(1), R





23

09

Poznan 5938

Bag. Laminated Non-Woven.
Tasche. Laminiertes Non-Woven.
Sac. T.N.T. Laminé.
Tas. Gelamineerd Non-Woven.

45 x 44 cm 200 / 10 Print Code: F(t)



22



05

Flubber 3306

Bag. Laminated Non-Woven.
Tasche. Laminiertes Non-Woven.
Sac. T.N.T. Laminé.
Tas. Gelamineerd Non-Woven.

40 x 35 x 11.5 cm 200 / 20 Print Code: F(t)



07

13

02



01

04

19

03



02

19

03

Pabbie 1248

Cool Bag. Laminated Non-Woven/ Aluminium.
Kühltasche. Laminiertes Non-Woven/ Aluminium.
Glacière. T.N.T. Laminé/ Aluminium.
Koeltas. Gelamineerd Non-Woven/ Aluminium.

23 x 29 x 14 cm 100 / 50 Print Code: G(t)



01

Laminated Non-woven



Fimel 5376

Bag. Laminated Non-Woven.
Tasche. Laminiertes Non-Woven.
Sac. T.N.T. Laminé.
Tas. Gelamineerd Non-Woven.

35 x 40 x 15 cm 200 / 10 Print Code: F(1)



Kustal 5375

Bag. Laminated Non-Woven.
Tasche. Laminiertes Non-Woven.
Sac. T.N.T. Laminé.
Tas. Gelamineerd Non-Woven.

30 x 34 x 12 cm 300 / 10 Print Code: F(1)



Natia 4775

Bag. Laminated Non-Woven.
Tasche. Laminiertes Non-Woven.
Sac. T.N.T. Laminé.
Tas. Gelamineerd Non-Woven.

38 x 38 x 12.5 cm 200 / 10 Print Code: F(1)



Divia 4422

Bag. Laminated Non-Woven.
Tasche. Laminiertes Non-Woven.
Sac. T.N.T. Laminé.
Tas. Gelamineerd Non-Woven.

38 x 40 x 12 cm 200 / 10 Print Code: F(1)



HEAT SEALED



19

Cattyr 5252

Bag, Non-Woven.
Tasche, Non-Woven.
Sac, T.N.T..
Tas, Non-Woven.

32 x 49 x 15 cm 200 / 10 Print Code: F(1)



03 04 11 02 07 05 01



11

Karean 5253

Bag, Non-Woven.
Tasche, Non-Woven.
Sac, T.N.T..
Tas, Non-Woven.

52 x 40.5 x 15 cm 200 / 10 Print Code: F(1)



07 19 04 05 02 03 01



02

Tucson 3209

Bag, Thick Non-Woven.
Tasche, Dicks Non-Woven.
Sac, T.N.T. Épais.
Tas, Dikke Non-Woven.

40 x 32 x 11 cm 200 / 50 Print Code: F(1)



07 19 03 04



02

Shopper 3244

Bag, Non-Woven.
Tasche, Non-Woven.
Sac, T.N.T..
Tas, Non-Woven.

40 x 35 x 10 cm 200 / 10 Print Code: F(1)

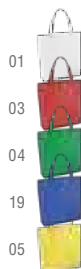
01
03
04
19
05

19

Blastar 5448

Foldable Bag, Non-Woven.
Faltbare Tasche, Non-Woven.
Sac Pliable, T.N.T..
Opvouwbare Tas, Non-Woven.

36 x 40 x 8 cm 200 / 10 Print Code: G(1), H(1)



02 11 03 05 16

Foldable
Bag

03

Konsum 3299

Foldable Bag, Non-Woven.
Faltbare Tasche, Non-Woven.
Sac Pliable, T.N.T..
Opvouwbare Tas, Non-Woven.

38 x 42 cm 200 / 50 Print Code: F(1), G(1), H(1)

19
02
01
07
04

Non-woven Bags



HEAT SEALED



21 04 05 07 03 11 17 06

425

BAGS

Jazzin 4622

Bag. Non-Woven.
Tasche. Non-Woven.
Sac. T.N.T.
Tas. Non-Woven.



36 x 40 cm 250 / 25 Print Code: F(1) 02 01 19



HEAT SEALED



HEAT SEALED

02

01 03 19 06

NEW COLOR

Desmond 3307

Bag. Non-Woven.
Tasche. Non-Woven.
Sac. T.N.T.
Tas. Non-Woven.

23 x 35 cm 400 / 20 Print Code: F(1)



HEAT SEALED

02

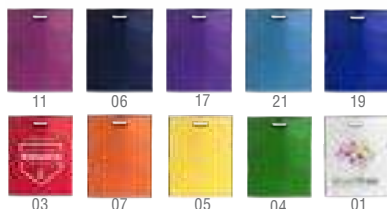

11 06 17 21 19
03 07 05 04 01

Blaster 3200

Bag. Non-Woven.
Tasche. Non-Woven.
Sac. T.N.T.
Tas. Non-Woven.

34 x 43 cm 400 / 20 Print Code: F(1)



01 02 19 04 05
07 03 06 17 21

Nox 4170

Bag. Non-Woven.
Tasche. Non-Woven.
Sac. T.N.T.
Tas. Non-Woven.

38 x 35 cm 250 / 50 Print Code: F(1)



Nazzer 6434

Bag, Non-Woven.
Tasche, Non-Woven.
Sac, T.N.T.
Tas, Non-Woven.

36 x 40 cm 250 / 25 Print Code: F(1)



Fesor 6437

Foldable Bag, Non-Woven.
Faltbare Tasche, Non-Woven.
Sac Pliable, T.N.T.
Opvouwbare Tas, Non-Woven.

38 x 42 cm 200 / 50 Print Code: F(1), G(1)



FOLDABLE



Bayson 6435

Bag, Non-Woven.
Tasche, Non-Woven.
Sac, T.N.T.
Tas, Non-Woven.

40 x 32 x 11 cm 200 / 50 Print Code: F(1)



Kinam 6436

Bag, Non-Woven.
Tasche, Non-Woven.
Sac, T.N.T.
Tas, Non-Woven.

25 x 31 x 11 cm 200 / 25 Print Code: F(1)

Recycled
Non Woven



02

Prastol 2625



01

Suntek 2624



02

Planet 2623



01

Tribus 2626



01

Liyen 2627

Planet 2623

Bag. Recycled Non-Woven.
Tasche. Recycling Non-Woven.
Sac. T.N.T. Recyclé.
Tas. Gerecycled Non-Woven.

30 x 40 x 10 cm 200 Print Code: F(1)



01

BAGS

427

Suntek 2624

Bag. Recycled Non-Woven.
Tasche. Recycling Non-Woven.
Sac. T.N.T. Recyclé.
Tas. Gerecycled Non-Woven.

38 x 42 cm 200 Print Code: F(1)



02

Prastol 2625

Bag. Recycled Non-Woven.
Tasche. Recycling Non-Woven.
Sac. T.N.T. Recyclé.
Tas. Gerecycled Non-Woven.

48 x 36.5 x 12 cm 200 Print Code: F(1)



01

Liyen 2627

Bag. Laminated Recycled Non-Woven.
Tasche. Laminiertes Recycling Non-Woven.
Sac. T.N.T. Recyclé Laminé.
Tas. Gelamineerd Gerecycled Non-Woven.

35 x 40 x 12 cm 150 Print Code: F(1)



02

Tribus 2626

Bag. Laminated Recycled Non-Woven.
Tasche. Laminiertes Recycling Non-Woven.
Sac. T.N.T. Recyclé Laminé.
Tas. Gelamineerd Gerecycled Non-Woven.

40 x 35 x 12 cm 150 Print Code: F(1)



02

SUBLIMATION

Mirtal 4478



Sublimation Bag, Non-Woven.
Sublimations Tasche, Non-Woven.
Sac Sublimation, T.N.T.
Sublimatie Tas, Non-Woven.

36 x 40 cm 400 / 20
Print Code: F(1), N(8), R



Wercal 6115



Sublimation Bag, Non-Woven.
Sublimations Tasche, Non-Woven.
Sac Sublimation, T.N.T.
Sublimatie Tas, Non-Woven.

34 x 43 cm 400 / 20
Print Code: F(1), N(8), R



Godon 1831

Sublimation Bag, Non-Woven.
Sublimations Tasche, Non-Woven.
Sac Sublimation, T.N.T.
Sublimatie Tas, Non-Woven.

35 x 40 x 15 cm 200 / 10
Print Code: F(1), N(8), R



Gwen 1830

Sublimation Bag, Non-Woven.
Sublimations Tasche, Non-Woven.
Sac Sublimation, T.N.T.
Sublimatie Tas, Non-Woven.

38 x 35 cm 250 / 50
Print Code: F(1), N(8), R

SOFT TOUCH



Prosum 6431

Sublimation Bag, Polyester.
Sublimations Tasche, Polyester.
Sac Sublimation, Polyester.
Sublimatie Tas, Polyester.

38 x 42 cm 100 / 10
Print Code: F(1), N(8), R



RECYCLED PAPER Bags



REINFORCEMENT
HANDLE



Drimul 2630

Bag, Recycled Paper 80 g/ m².
Tasche, Recycling Papier 80 g/ m².
Sac, Papier Recyclé 80 g/ m².
Tas, Gerecycled Papier 80 g/ m².

30 x 36 x 18 cm 400 Print Code: E(1)



Haspun 2629

Bag, Recycled Paper 80 g/ m².
Tasche, Recycling Papier 80 g/ m².
Sac, Papier Recyclé 80 g/ m².
Tas, Gerecycled Papier 80 g/ m².

26 x 36 x 12 cm 500 Print Code: E(1)



Collins 2628

Bag, Recycled Paper 80 g/ m².
Tasche, Recycling Papier 80 g/ m².
Sac, Papier Recyclé 80 g/ m².
Tas, Gerecycled Papier 80 g/ m².

22 x 27 x 11 cm 500 Print Code: E(1)



Cynthia 2720

Bag. Recycled Paper 100 g/ m2.
Tasche. Recycling Papier 100 g/ m2.
Sac. Papier Recyclé 100 g/ m2.
Tas. Gerecycled Papier 100 g/ m2.

32 x 40 x 12 cm 200 Print Code: F(1)

Taurel 2719

Bag. Recycled Paper 100 g/ m2.
Tasche. Recycling Papier 100 g/ m2.
Sac. Papier Recyclé 100 g/ m2.
Tas. Gerecycled Papier 100 g/ m2.

25 x 31 x 11 cm 200 Print Code: F(1)

Yeman 2721

Bag. Recycled Paper 100 g/ m2.
Tasche. Recycling Papier 100 g/ m2.
Sac. Papier Recyclé 100 g/ m2.
Tas. Gerecycled Papier 100 g/ m2.

22 x 23 x 9 cm 200 Print Code: F(1)

Mepus 2730

Bag. Recycled Paper 100 g/ m2.
Tasche. Recycling Papier 100 g/ m2.
Sac. Papier Recyclé 100 g/ m2.
Tas. Gerecycled Papier 100 g/ m2.

32 x 40 x 12 cm 200 Print Code: F(1)

Linel 2729

Bag. Recycled Paper 100 g/ m2.
Tasche. Recycling Papier 100 g/ m2.
Sac. Papier Recyclé 100 g/ m2.
Tas. Gerecycled Papier 100 g/ m2.

25 x 31 x 11 cm 200 Print Code: F(1)

Fortis 2731

Bag. Recycled Paper 100 g/ m2.
Tasche. Recycling Papier 100 g/ m2.
Sac. Papier Recyclé 100 g/ m2.
Tas. Gerecycled Papier 100 g/ m2.

22 x 23 x 9 cm 200 Print Code: F(1)

Cynthia 2720

Taurel 2719

Yeman 2721

Mepus 2730

Linel 2729

Fortis 2731



Nauska 5485

Bag. Recycled Paper 100 g/ m2.
Tasche. Recycling Papier 100 g/ m2.
Sac. Papier Recyclé 100 g/ m2.
Tas. Gerecycled Papier 100 g/ m2.

 32 x 40 x 12 cm  200  Print Code: F(1)



Nauska 5485

Loiles 5484

Bag. Recycled Paper 100 g/ m2.
Tasche. Recycling Papier 100 g/ m2.
Sac. Papier Recyclé 100 g/ m2.
Tas. Gerecycled Papier 100 g/ m2.

 25 x 31 x 11 cm  200  Print Code: F(1)



Loiles 5484

Cention 5483

Bag. Recycled Paper 100 g/ m2.
Tasche. Recycling Papier 100 g/ m2.
Sac. Papier Recyclé 100 g/ m2.
Tas. Gerecycled Papier 100 g/ m2.

 22 x 23 x 9 cm  200  Print Code: F(1)



Cention 5483

Tobin 5486

Bag. Recycled Paper 100 g/ m2.
Tasche. Recycling Papier 100 g/ m2.
Sac. Papier Recyclé 100 g/ m2.
Tas. Gerecycled Papier 100 g/ m2.

 41 x 32 x 15 cm  200  Print Code: F(1)



Tobin 5486

Take Away 5482

Bag. Recycled Paper 80 g/ m2.
Tasche. Recycling Papier 80 g/ m2.
Sac. Papier Recyclé 80 g/ m2.
Tas. Gerecycled Papier 80 g/ m2.

 30 x 29 x 18 cm  200  Print Code: F(1)



Take Away 5482

Ragnar 5487

Bag. Recycled Paper 100 g/ m2.
Tasche. Recycling Papier 100 g/ m2.
Sac. Papier Recyclé 100 g/ m2.
Tas. Gerecycled Papier 100 g/ m2.

 11 x 36 x 10 cm  500 / 100  Print Code: F(1)



Ragnar 5487



FOLDABLE

03

Daniels 3311

Cool Bag. Polyester 190T/ Aluminium. Foldable.
Kühltasche. Polyester 190T/ Aluminium. Faltbar.
Glacière. Polyester 190T/ Aluminium. Pliable.
Koeltas. Polyester 190T/ Aluminium. Opvouwbaar.

45 x 36 x 9 cm 100 / 20 Print Code: G(1)



02

05



04

19



19



02



03

Yonner 6277

Thermal Picnic Basket. Polyester 600D/ Aluminium. Foldable.
Wärme Tasche. Polyester 600D/ Aluminium. Faltbar.
Sac Thermique. Polyester 600D/ Aluminium. Pliable.
Thermo-Tasje. Polyester 600D/ Aluminium. Opvouwbaar.

47 x 25 x 28 cm 20 Print Code: H(1), N(8)



FOLDABLE

RECYCLED
PAPER



RECYCLED
PAPER

Saban 6372

Thermal Bag. Laminated Recycled Paper/ Aluminium.
Wärme Tasche. Laminiertes Recycling Papier/ Aluminium.
Sac Thermique. Papier Recyclé Laminé/ Aluminium.
Thermo-Tasje. Gelamineerd Gerecycled Papier/ Aluminium.

43 x 33 x 14 cm 100 Print Code: G(1)



ZIPPER



Dorothy 1731

Basket. Polyester 600D RPET. Foldable.
Tasche. Polyester 600D RPET. Faltbar.
Sac. Polyester 600D RPET. Pliable.
Tasje. Polyester 600D RPET. Opvouwbaar.

46 x 26 x 29 cm 10 Print Code: H(1), N(8)



FOLDABLE



JUTE

Benorax 1117

Shopping Trolley. Jute. Foldable.
Einkaufstrolley. Jutestoff. Faltbar.
Caddie Course. Jute. Pliable.
Inkoopwagentje. Jute. Opvouwbaar.

30 x 52 x 20 cm 10 Print Code: H(1), N(8)



RPET

Daggio 1118

Shopping Trolley. Polyester 600D RPET. Foldable.
Einkaufstrolley. Polyester 600D RPET. Faltbar.
Caddie Course. Polyester 600D RPET. Pliable.
Inkoopwagentje. Polyester 600D RPET. Opvouwbaar.

30 x 52 x 20 cm 10 Print Code: H(1), N(8)



04



06



19

FOLDABLE

Fasty 4612

Shopping Trolley. Polyester 600D. Foldable.
Einkaufstrolley. Polyester 600D. Faltbar.
Caddie Course. Polyester 600D. Pliable.
Inkoopwagentje. Polyester 600D. Opvouwbaar.

32 x 54 x 13.5 cm 30 Print Code: H(1), N(8)



03



02



03

Max 3228

Shopping Trolley. Polyester 600D. Foldable.
Einkaufstrolley. Polyester 600D. Faltbar.
Caddie Course. Polyester 600D. Pliable.
Inkoopwagentje. Polyester 600D. Opvouwbaar.

30 x 52 x 20 cm 6 Print Code: H(1), N(8)



19



Fully customized bags.
Create your own design.



10 LET'S WRITE





**IMAGINE,
WRITE,
CREATE**

NATURAL STONE

extract



Zircon 6949

Pen. Natural Stone Extracts/ PP. Jumbo Refill.
Kugelschreiber. Natursteinextrakte/ PP. Jumbo Mine.
Stylo. Extraits de Pierre Naturelle/ PP. Recharge Jumbo.
Pen. Extracten van Natuursteen/ PP. Jumbo Refill.

Ø 1.1 x 13.8 cm 1000/50 Print Code: B(4)



MADE FROM COFFEE -FIBER-



! +10.000 uds
PRINTING 12% Dto.

Bropex 1678

Pen. Coffee Fibre/ ABS.
Kugelschreiber. Kaffeeleaser/ ABS.
Stylo. Fibre de café/ ABS.
Pen. Koffievezel/ ABS.

Ø 1 x 14.1 cm 1000/50 Print Code: B(1)



MADE FROM -RECYCLED- MILK CARTON



**NEW
COLOR**

Roliok 1677

Pen. Recycled Milk Cartons.
Kugelschreiber. Recycelte Milchkartons.
Stylo. Cartons de Lait Recyclés.
Pen. Gerecycleerde Melkpakken.

Ø 1 x 14 cm 1000/50 Print Code: B(4)

01



**SUGAR
CANE
FIBER**

New



! +10.000 uds
PRINTING 12% Dto.

Perte 20641

Pen. Sugar Cane/ ABS.
Kugelschreiber. Zuckerrohr/ ABS.
Stylo. Canne à Sucre/ ABS.
Pen. Suikerriet/ ABS.

Ø 0.8 x 12.9 cm 1000 / 50 Print Code: A(4)

**WHEAT
STRAW**

New

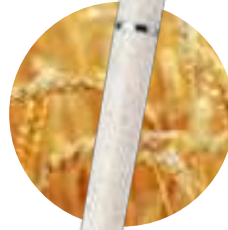

! +10.000 uds
PRINTING 12% Dto.

Rafton 20640

Pen. Wheat Straw/ ABS.
Kugelschreiber. Weizenstroh/ ABS.
Stylo. Paille de Blé/ ABS.
Pen. Tarwestro/ ABS.

Ø 0.8 x 12.9 cm 1000 / 50 Print Code: A(4)

**COFFEE
-FIBER-**

New



! +10.000 uds
PRINTING 12% Dto.

Trall 20642

Pen. Coffee Fibre/ ABS.
Kugelschreiber. Kaffeefaser/ ABS.
Stylo. Fibre de café/ ABS.
Pen. Koffievezel/ ABS.

Ø 0.8 x 12.9 cm 1000 / 50 Print Code: A(4)

BAMBOO

New



! +5.000 uds
PRINTING 12% Dto.

Stenson 20643

Pen. Bamboo.
Kugelschreiber. Bambus.
Stylo. Bambou.
Pen. Bamboe.

Ø 1.1 x 13.7 cm 1000 / 50
Print Code: A(4), L1

AL
RECYCLED

New



! +5.000 uds
PRINTING 12% Dto.

Reist 20644

Pen. Recycled Aluminium.
Kugelschreiber. Recycling Aluminium.
Stylo. Aluminium Recyclé.
Pen. Gerecycled Aluminium.

Ø 0.8 x 12.9 cm 1000 / 50
Print Code: B(4), L1

**NATURAL
CORK**

New



! +5.000 uds
PRINTING 12% Dto.

Milwaky 20645

Pen. Cork.
Kugelschreiber. Kork.
Stylo. Liège.
Pen. Kurk.

Ø 1.1 x 13.7 cm 1000 / 50
Print Code: A(4), L1



05 19 04 13 03 02

Desok 6773

Pen. Recycled Cardboard/ Wheat Straw/ ABS.
Kugelschreiber. Recycling Pappé/ Weizenstroh/ ABS.
Stylo. Carton Recyclé/ Paille de Blé/ ABS.
Pen. Gerecycled Karton/ Tarwestro/ ABS.

Ø 0.9 × 13.7 cm 1000 / 50 Print Code: A(4), W



07



19 13 04 02

Cezon 20226

Pen. Recycled Cardboard/ Wheat Straw/ ABS.
Kugelschreiber. Recycling Pappé/ Weizenstroh/ ABS.
Stylo. Carton Recyclé/ Paille de Blé/ ABS.
Pen. Gerecycled Karton/ Tarwestro/ ABS.

Ø 1 × 13.7 cm 1000 / 50 Print Code: A(4)

New



03



19 03 02

Salcen 6496

Pen. Recycled Cardboard/ Wheat Straw/ ABS.
Kugelschreiber. Recycling Pappé/ Weizenstroh/ ABS.
Stylo. Carton Recyclé/ Paille de Blé/ ABS.
Pen. Gerecycled Karton/ Tarwestro/ ABS.

Ø 1 × 14 cm 1000 / 50 Print Code: A(4), W



13



02 01 04 05 07 03 11

Tori 3564

Pen. Recycled Cardboard.
Kugelschreiber. Recycling Pappé.
Stylo. Carton Recyclé.
Pen. Gerecycled Karton.

Ø 0.9 × 13.7 cm 1000 / 50 Print Code: A(4), W



19



02 19 07 03 01

Compo 9696

Pen. Recycled Cardboard. Black Ink.
Kugelschreiber. Recycling Pappé. Schwarze Tinte.
Stylo. Carton Recyclé. Encre Noire.
Pen. Gerecycled Karton. Zwartte Inkt.

Ø 1 × 14 cm 1000 / 50 Print Code: A(4), W



04



03 04 02 01

Than 4903

Stylus Touch Ball Pen. Recycled Cardboard.
Kugelschreiber Pointer. Recycling Pappé.
Styler Bille. Carton Recyclé.
Touch-Screen Balpen. Gerecycled Karton.

Ø 1 × 13.8 cm 1000 / 50 Print Code: A(4), W



19



New

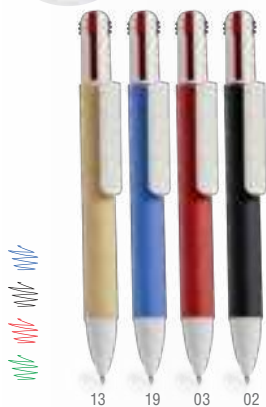

13 19 03 02

Surtum 21076

Pen. Recycled Paper/ Wheat Straw/ ABS. 4 Ink Colours.
Kugelschreiber. Recycling Papier/ Weizenstroh/ ABS. 4
Farben Tinte.

Stylo. Papier Recyclé/ Paille de Blé/ ABS. Écriture 4 Couleurs.
Pen. Gerecycled Papier/ Tarwestro/ ABS. 4 Kleuren Inkt.

Ø 1.4 x 14.4 cm 1000 / 50 Print Code: A(4), W

04

New



01 02 03 04 06 13

Uzor 20646

Pen. Recycled Paper. Jumbo Refill.
Kugelschreiber. Recycling Papier. Jumbo Mine.
Stylo. Papier Recyclé. Recharge Jumbo.
Pen. Gerecycled Papier. Jumbo Refill.

Ø 1 x 13.8 cm 1000 / 50 Print Code: A(4)

RECYCLED PAPER

New

! +5.000 uds
PRINTING 12% Dto.



19 01 02 03 04 06

Dynix 20647

Pen. Recycled Paper.
Kugelschreiber. Recycling Papier.
Stylo. Papier Recyclé.
Pen. Gerecycled Papier.

Ø 1.1 x 13.9 cm 1000 / 50
Print Code: A(4)

13



01 03 19 04

Valvek 6321

Pen. Recycled Paper.
Kugelschreiber. Recycling Papier.
Stylo. Papier Recyclé.
Pen. Gerecycled Papier.

Ø 0.8 x 14.2 cm 1000 / 50 Print Code: A(4), W

13



Nazgun 1228

Pen. Recycled Cardboard/ Wood/ Wheat Straw/ ABS.
Kugelschreiber. Recycling Papper/ Holz/ Weizenstroh/ ABS.
Stylo. Carton Recyclé/ Bois/ Paille de Blé/ ABS.
Pen. Gerecycled Karton/ Hout/ Tarwestro/ ABS.

Ø 1 x 14 cm 1000 / 50 Print Code: A(4), L1, W



01 07 04 19 02

Vatum 6770

Pen. Recycled Cardboard/ PLA 100% Compostable.
Kugelschreiber. Recycling Papper/ PLA 100% Kompostierbar.
Stylo. Carton Recyclé/ PLA 100% Compostable.
Pen. Gerecycled Karton/ PLA 100% Composteerbaar.

Ø 0.9 x 13.7 cm 1000 / 50 Print Code: A(4), W

03

PLA



19

04

02

03

Sydor 6495



! +10.000 uds
PRINTING 12% Dto.

Pen. Bamboo/ Wheat Straw/ ABS.
Kugelschreiber. Bambus/ Weizenstroh/ ABS.
Stylo. Bambou/ Paille de Blé/ ABS.
Pen. Bamboe/ Tarwestro/ ABS.

Ø 1.1 x 14 cm 1000 / 50 Print Code: B(4)



13



02

19

03

01

Heloix 6771



Pen. Bamboo/ PLA 100% Compostable.
Kugelschreiber. Bambus/ PLA 100% Kompostierbar.
Stylo. Bambou/ PLA 100% Compostable.
Pen. Bamboe/ PLA 100% Composteerbaar.

Ø 1.1 x 14 cm 1000 / 50 Print Code: B(4)



04

PLA

New



Loev 20651



Stylus Touch Ball Pen. Bamboo.
Kugelschreiber Pointer. Bambus.
Stylet Bille. Bambou.
Touch-Screen Balpen. Bamboe.

Ø 1 x 14.6 cm 1000 / 50 Print Code: B(4), L1



01

22

Bracing 1672



Pen.
Kugelschreiber.
Stylo.
Pen.

Ø 1.7 x 10 cm 1000 / 50 Print Code: B(4)





13 02 04 19

Melky 20649

Pen. Bamboo/ Wheat Straw/ ABS. Jumbo Refill.
 Kugelschreiber. Bambus/ Weizenstroh/ ABS. Jumbo Mine.
 Stylo. Bambou/ Paille de Blé/ ABS. Recharge Jumbo.
 Pen. Bamboe/ Tarwestro/ ABS. Jumbo Refill.

Ø 1.2 x 14.3 cm 1000 / 50 Print Code: A(4), L1



03



01 02 03 04 08

Renol 20648

Pen. Bamboo.
 Kugelschreiber. Bambus.
 Stylo. Bambou.
 Pen. Bamboe.

Ø 1 x 14.3 cm 500 / 50 Print Code: B(4), L1



06



Clarion 6614

Holder Pen. Bamboo/ Wheat Straw/ ABS. Jumbo Refill.
 Kugelschreiber Halter. Bambus/ Weizenstroh/ ABS. Jumbo Mine.
 Stylo Support. Bambou/ Paille de Blé/ ABS. Recharge Jumbo.
 Pen-Houder. Bamboe/ Tarwestro/ ABS. Jumbo Refill.

Ø 1.1 x 14.2 cm 1000 / 50 Print Code: B(4)



02 03 04 13

Zonta 20650

Holder Pen. Bamboo/ Wheat Straw/ ABS. Jumbo Refill.
 Kugelschreiber Halter. Bambus/ Weizenstroh/ ABS. Jumbo Mine.
 Stylo Support. Bambou/ Paille de Blé/ ABS. Recharge Jumbo.
 Pen-Houder. Bamboe/ Tarwestro/ ABS. Jumbo Refill.

Ø 1.1 x 14.8 cm 1000 / 50 Print Code: A(4), L1





Heleon 5262

Set. Bamboe. Jumbo Refill Pen. Mechanical Pencil; 0,7 mm Leads Included.
 Set. Bambus. Kugelschreiber Jumbo Mine. Bleistift; Minen 0,7 mm Inklusive.
 Set. Bamboe. Stylo Recharge Jumbo. Portemines; Mines 0,7 mm Incluses.
 Set. Bamboe. Jumbo Refill Pen. Vulpotlood; 0,7 mm Stifjes Inclusief.

Ø 1.1 x 13.8 cm 300 / 25 Print Code: D(1), B(4)



+10.000 uds
 PRINTING 12% Dto.

Yiagan 5260

Pen. Bamboe. Jumbo Refill.
 Kugelschreiber. Bambus. Jumbo Mine.
 Stylo. Bamboe. Recharge Jumbo.
 Pen. Bamboe. Jumbo Refill.

Ø 1.1 x 13.8 cm 1000 / 50 Print Code: B(4)

Sirim 5261

Stylus Touch Ball Pen. Bamboe. Jumbo Refill.
 Kugelschreiber Pointer. Bambus. Jumbo Mine.
 Stylet Bille. Bamboe. Recharge Jumbo.
 Touch-Screen Balpen. Bamboe. Jumbo Refill.

Ø 1.1 x 13.8 cm 1000 / 50 Print Code: B(4)

Tamirox 6940

Roller. Bamboe. Jumbo Refill.
 Roller Pen. Bambus. Jumbo Mine.
 Roller. Bamboe. Recharge Jumbo.
 Roller. Bamboe. Jumbo Refill.

Ø 1.1 x 13.8 cm 1000 / 50 Print Code: B(4), L1

BAMBOO

New

Zharu 6886

Stylus Touch Ball Pen. Bamboo. Jumbo Refill.
Kugelschreiber Pointer. Bambus. Jumbo Mine.
Stylét Bille. Bambou. Recharge Jumbo.
Touch-Screen Balpen. Bamboe. Jumbo Refill.

Ø 1.1 × 14.1 cm 1000 / 50 Print Code: B(4)

**Clixo 20652**

Stylus Touch Ball Pen. Bamboo.
Kugelschreiber Pointer. Bambus.
Stylét Bille. Bambou.
Touch-Screen Balpen. Bamboe.

Ø 1.1 × 15.1 cm 500 / 50 Print Code: A(4)

**Lobart 6036**

Pen. Wood.
Kugelschreiber. Holz.
Stylo. Bois.
Pen. Hout.

Ø 1.1 × 13.8 cm 500 / 50 Print Code: B(1), L1

**Reycan 6612**

Pen. Bamboo.
Kugelschreiber. Bambus.
Stylo. Bambou.
Pen. Bamboe.

Ø 1.1 × 13.9 cm 1000 / 50 Print Code: B(4)



+5.000 uds
PRINTING 12% Dto.

Nikox 6072

Pen. Bamboo. Jumbo Refill. Black Ink.
Kugelschreiber. Bambus. Jumbo Mine. Schwarze Tinte.
Stylo. Bambou. Recharge Jumbo. Encre Noire.
Pen. Bamboe. Jumbo Refill. Zwarte Inkt.

Ø 1.1 × 13.9 cm 1000 / 50 Print Code: B(4)





WHEAT STRAW

New



Stello 20227



Pen. Cork/ Wheat Straw/ ABS. 4 Ink Colours.
Kugelschreiber. Kork/ Weizenstroh/ ABS. 4 Farben Tinte.
Stylo. Liège/ Paille de Blé/ ABS. Écriture 4 Couleurs.
Pen. Kurk/ Tarwestro/ ABS. 4 Kleuren Inkt.

 Ø 1.4 x 14.4 cm  1000 / 50  Print Code: B(4), L1



New

NEW COLOR





21 02 13

Yarden 6774



Pen. Cork/ Wheat Straw/ ABS.
Kugelschreiber. Kork/ Weizenstroh/ ABS.
Stylo. Liège/ Paille de Blé/ ABS.
Pen. Kurk/ Tarwestro/ ABS.

 Ø 0.9 x 13.7 cm  1000 / 50  Print Code: A(4), L1



04

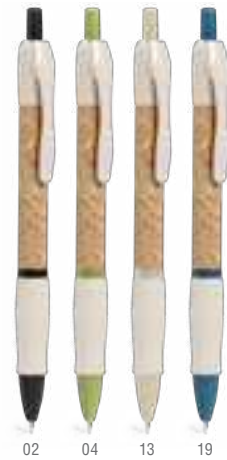

02 04 13 19

! +10.000 uds
PRINTING 12% Dto.

Ankor 20225



Pen. Cork/ Wheat Straw/ ABS.
Kugelschreiber. Kork/ Weizenstroh/ ABS.
Stylo. Liège/ Paille de Blé/ ABS.
Pen. Kurk/ Tarwestro/ ABS.

 Ø 1.1 x 14.5 cm  1000 / 50  Print Code: A(4), L1



03



04

Clover 6332



Pen. Cork/ Wheat Straw/ ABS.
Kugelschreiber. Kork/ Weizenstroh/ ABS.
Stylo. Liège/ Paille de Blé/ ABS.
Pen. Kurk/ Tarwestro/ ABS.

 Ø 1 x 13.5 cm  1000 / 50  Print Code: A(4), W



13

ETERNAL Writing

No need to sharpen



New



3 in 1
MULTI-FUNCTION

02 01 06



ERASER

02 01 08



02 01

+5.000 uds
PRINTING 12% Dto.



02 01 09 04 19 06

Teluk 1680

Multifunction Eternal Pencil. Recycled Aluminium. 3 Functions.
Multifunktion Ewiger Bleistift. Recycling Aluminium. 3 Funktionen.
Crayon Éternel Multifonction. Aluminium Recyclé. 3 Fonctions.
Multifunctioneel Bleistift. Gerecycled Aluminium. 3 Functies.

1.4 x 14.8 x 1.4 cm 500 / 50
Print Code: B(4), L1

Gosfor 1489

Eternal Stylus Touch Pencil. Aluminium.
Ewiger Bleistift Pointer. Aluminium.
Stylét Crayon Éternel. Aluminium.
Touch-Screen Bleistift. Aluminium.

Ø 0.9 x 14.3 cm 500 / 50
Print Code: B(4), L1

Holwick 1455

Eternal Pencil Pen. Metal. Jumbo Refill.
Ewiger Bleistift Kugelschreiber. Metall. Jumbo Mine.
Stylo Crayon Éternel. Métal. Recharge Jumbo.
Bleistift Pen. Metaal. Jumbo Refill.

Ø 1 x 13.7 cm 300 / 50
Print Code: D(1), B(4), L1

May 20182

Eternal Pencil Pen.
Ewiger Bleistift Kugelschreiber.
Stylo Crayon Éternel.
Bleistift Pen.

Ø 1 x 14 cm 1000 / 50 Print Code: A(4)

+5.000 uds
PRINTING 12% Dto.



Seryi 20146

Eternal Pencil. Bamboo. File Included.
Ewiger Bleistift. Bambus. Feile inklusive.
Crayon Éternel. Bambou. Lime Incluse.
Bleistift. Bamboe. Vjfl Inclusief.

Ø 0.8 × 15 cm 200 / 50 Print Code: C(4), L1

ETERNAL Writing

ERASER AND HOLDER



02



13

Soiny 20680

Eternal Pencil. Recycled Cardboard.
Ewiger Bleistift. Recycling Pappe.
Crayon Éternel. Carton Recyclé.
Bleistift. Gerecycled Karton.

Ø 3 × 13.8 cm 200 / 50 Print Code: C(4)

New



02 04 13 19

New



03

Depex 21077

Eternal Pencil. Recycled Cardboard.
Ewiger Bleistift. Recycling Pappe.
Crayon Éternel. Carton Recyclé.
Bleistift. Gerecycled Karton.

Ø 0.9 × 15.8 cm 1000 / 50
Print Code: A(4)



Yeidy 1288

Eternal Pencil. Recycled Cardboard/ Wheat Straw/ ABS.
Ewiger Bleistift. Recycling Pappe/ Weizenstroh/ ABS.
Crayon Éternel. Carton Recyclé/ Paille de Blé/ ABS.
Bleistift. Gerecycled Karton/ Tarwestro/ ABS.

Ø 0.8 × 13.9 cm 1000 / 50
Print Code: A(4), W



19 01 02 03 05 07

Baxter 20374

Eternal Pencil. Recycled ABS.
Ewiger Bleistift. Recycling Pappe.
Crayon Éternel. ABS Recyclé.
Bleistift. Gerecycled ABS.

Ø 0.8 × 15.3 cm 1000 / 100
Print Code: A(4)

New



04



01 02 03 04 05 07

Astril 20375

Eternal Pencil.
Ewiger Bleistift.
Crayon Éternel.
Bleistift.

Ø 0.9 × 14.4 cm 2000 / 100
Print Code: A(4)

New



19

New

! +5.000 uds
PRINTING 12% Dto.

Chidex 20147

Eternal Pencil. Bamboo.
Ewiger Bleistift. Bambus.
Crayon Éternel. Bambou.
Bleistift. Bamboe.

Ø 1.1 x 13.5 cm 1000 / 50
Print Code: B(4)



Zack 20183

Eternal Pencil Pen. Bamboo. Jumbo Refill.
Cotton Pouch.
Ewiger Bleistift Kugelschreiber. Bambus.
Jumbo Mine. Baumwolle. Étui.
Stylo Crayon Éternel. Bambou. Recharge
Jumbo. Étui Coton.
Bleistift Pen. Bamboo. Jumbo Refill. Katoen
Zakje.

Ø 1 x 15 cm 1000 / 50
Print Code: B(4), F(1), L1, N(8)

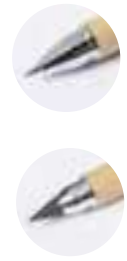

ERASER



STYLUS
TOUCH

Grabit 21078

Eternal Pencil. Cork.
Ewiger Bleistift. Kork.
Crayon Éternel. Liège.
Bleistift. Kurk.

Ø 0.9 x 15.8 cm 1000 / 50
Print Code: A(4), L1



Suriak 1580

Multifunction Eternal Pencil. Bamboo. 3 Functions.
Multifunktion Ewiger Bleistift. Bambus. 3 Funktionen.
Crayon Éternel Multifonction. Bambou. 3 Fonctions.
Multifunctioneel Bleistift. Bamboe. 3 Functies.

Ø 1 x 14.8 cm 500 / 50
Print Code: B(4), L1



Billy 20145

Eternal Pencil. Bamboo.
Ewiger Bleistift. Bambus.
Crayon Éternel. Bambou.
Bleistift. Bamboe.

Ø 0.8 x 15.4 cm 1000 / 50
Print Code: A(4), L1



Tebel 1289

Eternal Pencil. Bamboo.
Ewiger Bleistift. Bambus.
Crayon Éternel. Bambou.
Bleistift. Bamboe.

Ø 0.8 x 13.7 cm 1000 / 50
Print Code: A(4), L1





Arvonix 21080

Pen. Bamboo/ Paper. Jumbo Refill.
Kugelschreiber. Bambus/ Papier. Jumbo Mine.
Stylo. Bambou/ Papier. Recharge Jumbo.
Pen. Bamboe/ Papier. Jumbo Refill.

Ø 1.1 x 14.1 cm 1000 / 50
Print Code: B(4)

03



Filipo 21081

Stylus Touch Ball Pen. Bamboo/ Paper.
Kugelschreiber Pointer. Bambus/ Papier.
Styler Bille. Bambou/ Papier.
Touch-Screen Balpen. Bamboe/ Papier.

Ø 1.1 x 15.2 cm 1000 / 50
Print Code: B(4)

03



Lantasker 21079

Pen. Aluminium/ Bamboo. Jumbo Refill.
Kugelschreiber Aluminium/ Bambus. Jumbo Mine.
Stylo. Aluminium/ Bambou. Recharge Jumbo.
Pen. Aluminium/ Bamboe. Jumbo Refill.

Ø 1 x 14 cm 500 / 50
Print Code: L1

06



Berget 20655

Stylus Touch Ball Pen. Aluminium/ Bamboo.
Kugelschreiber Pointer. Aluminium/ Bambus.
Styler Bille. Aluminium/ Bambou.
Touch-Screen Balpen. Aluminium/ Bamboe.

Ø 1 x 14.6 cm 500 / 50
Print Code: B(1), L1

19



Piket 20656

Stylus Touch Ball Pen. Aluminium/ Bamboo.
Kugelschreiber Pointer. Aluminium/ Bambus.
Styler Bille. Aluminium/ Bambou.
Touch-Screen Balpen. Aluminium/ Bamboe.

Ø 1 x 14.5 cm 500 / 50
Print Code: B(1), L1

03



! +5.000 uds
PRINTING 12% Dto.



Weler 20654

Pen. Aluminium/ Bamboo.
Kugelschreiber. Aluminium/ Bambus.
Stylo. Aluminium/ Bambou.
Pen. Aluminium/ Bamboe.

Ø 1 x 14.3 cm 500 / 50 Print Code: B(1), L1



03



Chiatox 6939

Pen. Aluminium/ Bamboo.
Kugelschreiber. Aluminium/ Bambus.
Stylo. Aluminium/ Bambou.
Pen. Aluminium/ Bamboe.

Ø 1 x 14.2 cm 500 / 50 Print Code: L1



06



Zenet 20653

Pen. Aluminium/ Cork.
Kugelschreiber. Aluminium/ Kork.
Stylo. Aluminium/ Liège.
Pen. Aluminium/ Kurk.

Ø 1 x 14.3 cm 500 / 50 Print Code: B(1), L1

! +5.000 uds
PRINTING 12% Dto.



02



Moson 21075

Stylus Touch Ball Pen. Aluminium/ Cork.
Kugelschreiber Pointer. Aluminium/ Kork.
Styleret Bille. Aluminium/ Liège.
Touch-Screen Balpen. Aluminium/ Kurk.

Ø 1 x 15 cm 500 / 50 Print Code: B(1), L1



08



RUBBER FINISH

SPECIAL LASER ENGRAVING SILVER LOGO

These pens have an outer coating specially designed for laser engraving, which will ensure that your advertising or brand is perfectly engraved in a shining silver colour.



NEW COLOR



06 01 02 03 04 07 19

Lekor 6367

Stylus Touch Ball Pen. Aluminium. Jumbo Refill.
Kugelschreiber Pointer. Aluminium. Jumbo Mine.
Stylt Bille. Aluminium. Recharge Jumbo.
Touch-Screen Balpen. Aluminium. Jumbo Refill.

Ø 1 x 14.5 cm 500 / 50
Print Code: L1

NEW COLOR



06 01 03 19 02 05 07

Zromen 6366

Pen. Aluminium. Jumbo Refill.
Kugelschreiber. Aluminium. Jumbo Mine.
Stylo. Aluminium. Recharge Jumbo.
Pen. Aluminium. Jumbo Refill.

Ø 1 x 13.9 cm 500 / 50
Print Code: B(4), L1



06 01 19 02 03

Blavix 6368

Pen. Aluminium. Jumbo Refill.
Kugelschreiber. Aluminium. Jumbo Mine.
Stylo. Aluminium. Recharge Jumbo.
Pen. Aluminium. Jumbo Refill.

Ø 1 x 13.7 cm 500 / 50
Print Code: B(4), L1

New



09 19 04

Piklam 21083

Pen. Aluminium/ Bamboe.
Kugelschreiber. Aluminium/ Bambus.
Stylo. Aluminium/ Bamboe.
Pen. Aluminium/ Bamboe.

Ø 1.1 x 14.4 cm 500 / 50
Print Code: L1



03 07 09 19

Yaret 5975

Stylus Touch Ball Pen. Aluminium. Jumbo Refill.
Kugelschreiber Pointer. Aluminium. Jumbo Mine.
Stylt Bille. Aluminium. Recharge Jumbo.
Touch-Screen Balpen. Aluminium. Jumbo Refill.

Ø 1 x 14.2 cm 500 / 50
Print Code: L1



04



02 04 05 07 09 19

Woner 6078

Stylus Touch Ball Pen. Aluminium. Jumbo Refill.
Kugelschreiber Pointer. Aluminium. Jumbo Mine.
Stylt Bille. Aluminium. Recharge Jumbo.
Touch-Screen Balpen. Aluminium. Jumbo Refill.

Ø 1 x 14.2 cm 500 / 50
Print Code: B(4), L1



03



SPECIAL LASER ENGRAVING MATCHING COLOUR

These pens with colour interior have an outer coating specially designed for laser engraving, which will ensure that your advertising or brand is perfectly in the same colour as the inside of your chosen pen.



RUBBER FINISH



SPECIAL LASER ENGRAVING SILVER LOGO

These pens have an outer coating specially designed for laser engraving, which will ensure that your advertising or brand is perfectly engraved in a shining silver colour.



08 02 01 06 03
Zabox 6938 

Stylus Touch Ball Pen. Aluminium/ Bamboe.
Kugelschreiber Pointer. Aluminium/ Bambus.
Stylt Bille. Aluminium/ Bamboe.
Touch-Screen Balpen. Aluminium/ Bamboe.

 Ø 1 × 14,5 cm  500 / 50
 Print Code: L1





04



08 02 01 03 04
Logard 20149 

Pen. Cork/ Aluminium.
Kugelschreiber: Kork/ Aluminium.
Stylo. Liège/ Aluminium.
Pen. Kurk/ Aluminium.

 Ø 1 × 14,1 cm  500 / 50
 Print Code: B(4), L1





06



08 02 01 06 04
Kolka 20148 

Pen. Bamboe/ Aluminium.
Kugelschreiber. Bamboe/ Aluminium.
Stylo. Bamboe/ Aluminium.
Pen. Bamboe/ Aluminium.

 Ø 1 × 14,1 cm  500 / 50
 Print Code: B(4), L1



03

New

New

SPECIAL LASER ENGRAVING ROSE GOLD LOGO

These pens have an outer coating specially designed for laser engraving, which will ensure that your advertising or brand is perfectly engraved in a shining rose gold colour.



Taufl 20180

Stylus Touch Ball Pen. Aluminium. Jumbo Refill.
Kugelschreiber Pointer. Aluminium. Jumbo Mine.
Stylt Bille. Aluminium. Recharge Jumbo.
Touch-Screen Balpen. Aluminium. Jumbo Refill.

Ø 1 x 14,2 cm 500 / 50 Print Code: D(1), L1



Lance 20184

Pen. Aluminium. Jumbo Refill.
Kugelschreiber. Aluminium. Jumbo Mine.
Stylo. Aluminium. Recharge Jumbo.
Pen. Aluminium. Jumbo Refill.

Ø 1,2 x 14,1 cm 250 / 50 Print Code: D(1), L1



Kasey 20185

Roller. Aluminium. Jumbo Refill.
Roller. Aluminium. Jumbo Mine.
Roller. Aluminium. Recharge Jumbo.
Roller. Aluminium. Jumbo Refill.

Ø 1,2 x 13,6 cm 250 / 50 Print Code: D(1), L1



Noril 20660

Pen. Aluminium.
Kugelschreiber. Aluminium.
Stylo. Aluminium.
Pen. Aluminium.

Ø 0.8 x 12.9 cm 1000 / 50 Print Code: B(1), L1



Raitox 20659

Pen. Aluminium. Jumbo Refill.
Kugelschreiber. Aluminium. Jumbo Mine.
Stylo. Aluminium. Recharge Jumbo.
Pen. Aluminium. Jumbo Refill.

Ø 1 x 13.8 cm 500 / 50 Print Code: B(1), L1



Lixor 20658

Stylus Touch Ball Pen. Aluminium.
Kugelschreiber Pointer. Aluminium.
Stylet Bille. Aluminium.
Touch-Screen Balpen. Aluminium.

Ø 1 x 14.5 cm 500 / 50 Print Code: B(1), L1

! +5.000 uds
PRINTING 12% Dto.



19 02 04 09

! +5.000 uds
PRINTING 12% Dto.

Patrezen 20663

Pen. Recycled Aluminium. Jumbo Refill.
Kugelschreiber. Recycling Aluminium. Jumbo Mine.
Stylo. Aluminium Recyclé. Recharge Jumbo.
Pen. Gerecycled Aluminium. Jumbo Refill.

Ø 1 x 13.6 cm 500 / 50 Print Code: B(1), L1

New

RECYCLED AL
Aluminium



03



19 09 03 01

! +5.000 uds
PRINTING 12% Dto.

Brincio 1485

Pen. Recycled Aluminium. Jumbo Refill.
Kugelschreiber. Recycling Aluminium. Jumbo Mine.
Stylo. Aluminium Recyclé. Recharge Jumbo.
Pen. Gerecycled Aluminium. Jumbo Refill.

Ø 1 x 13.6 cm 500 / 50 Print Code: B(4), L1



02



09 03 02 01

Paterson 1484

Pen. Recycled Aluminium.
Kugelschreiber. Recycling Aluminium.
Stylo. Aluminium Recyclé.
Pen. Gerecycled Aluminium.

Ø 0.9 x 14 cm 500 / 50 Print Code: B(4), L1



19



19 09 02

Luggins 1675

Pen. Recycled Aluminium. Jumbo Refill.
Kugelschreiber. Recycling Aluminium. Jumbo Mine.
Stylo. Aluminium Recyclé. Recharge Jumbo.
Pen. Gerecycled Aluminium. Jumbo Refill.

Ø 1 x 13.7 cm 500 / 50 Print Code: B(4), L1

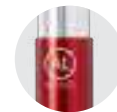

03

RECYCLED (AL) Aluminium



Fobox 20662

Stylus Touch Ball Pen. Recycled Aluminium/ Cork. Jumbo Refill.
 Kugelschreiber Pointer. Recycling Aluminium/ Kork. Jumbo Mine.
 Stylet Bille. Aluminium Recyclé/ Liège. Recharge Jumbo.
 Touch-Screen Balpen. Gerecycled Aluminium/ Kurk. Jumbo Refill.

Ø 1.1 x 14.1 cm 500 / 50 Print Code: B(1), L1

New

New



Fobox 20662

Deimox 20661

Deimox 20661

Stylus Touch Ball Pen. Recycled Aluminium/ Bamboo. Jumbo Refill.
 Kugelschreiber Pointer. Recycling Aluminium/ Bambus. Jumbo Mine.
 Stylet Bille. Aluminium Recyclé/ Bambou. Recharge Jumbo.
 Touch-Screen Balpen. Gerecycled Aluminium/ Bamboe. Jumbo Refill.

Ø 1.1 x 14.1 cm 500 / 50 Print Code: B(1), L1



02

01



New



08

02

01



Brilen 1676

Pen. Recycled Aluminium. Jumbo Refill.
 Kugelschreiber. Recycling Aluminium. Jumbo Mine.
 Stylo. Aluminium Recyclé. Recharge Jumbo.
 Pen. Gerecycled Aluminium. Jumbo Refill.

Ø 1.1 x 13.9 cm 500 / 50 Print Code: B(4), L1

Adam 20181

Pen. Recycled Aluminium/ Bamboo. Jumbo Refill.
 Kugelschreiber. Recycling Aluminium/ Bambus. Jumbo Mine.
 Stylo. Aluminium Recyclé/ Bambou. Recharge Jumbo.
 Pen. Gerecycled Aluminium/ Bamboe. Jumbo Refill.

Ø 1.1 x 14.3 cm 500 / 50 Print Code: B(4), L1



06



06

MADE FROM
-RECYCLED
LEATHER



Rayulk 1683

Pen. Recycled Leather/ Metal.
Kugelschreiber. Recycling Leder/ Metall.
Stylo. Cuir Recyclé/ Métal.
Pen. Gerecycled Leer/ Metaal.

Ø 1.2 x 14.1 cm 200 / 50 Print Code: B(4), D(1), L1



Rpet



Higolf 1681

Pen. Polyester RPET/ Metal.
Kugelschreiber. Polyester RPET/ Metall.
Stylo. Polyester RPET/ Métal.
Pen. Polyester RPET/ Metaal.

Ø 1 x 13.1 cm 200 / 50 Print Code: B(4), D(1), L1

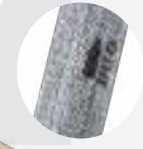

Wutax 1682

Pen. Recycled Stainless Steel. Jumbo Refill.
Kugelschreiber. Recycling Rostfreier Stahl. Jumbo Mine.
Stylo. Acier Inox Recyclé. Recharge Jumbo.
Pen. Gerecycled Roestvrij Staal. Jumbo Refill.

Ø 1 x 13.6 cm 200 / 50 Print Code: B(1), D(1), L1



RECYCLED
STAINLESS
STEEL

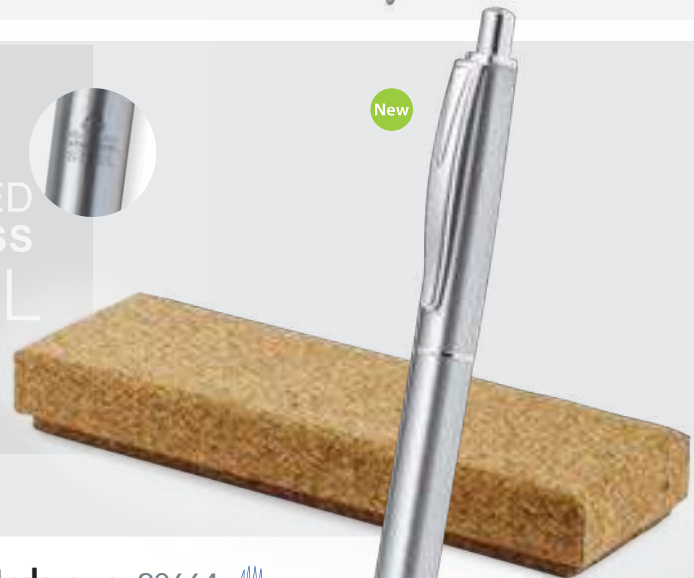

Lukonen 20664

Pen. Recycled Stainless Steel. Jumbo Refill.
Kugelschreiber. Recycling Rostfreier Stahl. Jumbo Mine.
Stylo. Acier Inox Recyclé. Recharge Jumbo.
Pen. Gerecycled Roestvrij Staal. Jumbo Refill.

Ø 1 x 14 cm 100 / 50
Print Code: B(1), D(1), L1

New





Gutier 20665

Pen. Metal/ Bamboo.
Kugelschreiber. Metall/ Bambus.
Stylo. Métal/ Bambou.
Pen. Metaal/ Bamboe.

Ø 1.2 × 13.6 cm 100 / 50 Print Code: B(1), L1



New

Jarviner 20667

Set. Metal/ Bamboo. Card Holder 1 Compartment. Pen.
Set. Metal/ Bambus. Visitenkartenetui 1 Abteilung. Kugelschreiber.
Set. Métal/ Bambou. Porte-Cartes 1 Compartiment. Stylo.
Set. Metaal/ Bamboe. Kaartjeshouder 1 Compartment. Pen.

17.1 × 2.6 × 12.7 cm 100 / 25 Print Code: D(1), E(1), L1, W



Siliax 6728

Pen. Cork/ Metal.
Kugelschreiber. Kork/ Metall.
Stylo. Liège/ Métal.
Pen. Kurk/ Metaal.

Ø 1.2 × 13.7 cm 300 / 50
Print Code: B(4), L1



Vamet 6333

Pen. Cork/ Metal.
Kugelschreiber. Kork/ Metall.
Stylo. Liège/ Métal.
Pen. Kurk/ Metaal.

Ø 1 × 13.5 cm 100 / 50
Print Code: B(4), D(1), L1



Fitin 20666

Pen. Metal/ Cork.
Kugelschreiber. Metall/ Kork.
Stylo. Métal/ Liège.
Pen. Metaal/ Kurk.

Ø 1.2 × 13.6 cm 100 / 50
Print Code: B(1), D(1), L1



RECYCLED
STAINLESS
STEEL

New



Rodrix 20685

Set. Recycled Stainless Steel. Pen and Roller. Jumbo Refill.

Set. Recycling Rostfreier Stahl. Kugelschreiber und Roller Pen. Jumbo Mine.

Set. Acier Inox Recyclé. Stylo et Roller. Recharge Jumbo.

Set. Gerecycled Roestvrij Staal. Pen en Roller. Jumbo Refill.

Ø 1 x 13.1 cm 100 / 25

Print Code: B(1), D(1), L1

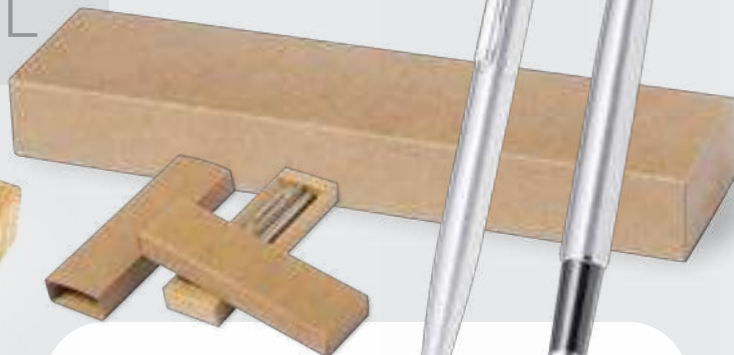

Kaylax 1684

Set. Recycled Stainless Steel. Pen and Roller. Jumbo Refill.

Set. Recycling Rostfreier Stahl. Kugelschreiber und Roller Pen. Jumbo Mine.

Set. Acier Inox Recyclé. Stylo et Roller. Recharge Jumbo.

Set. Gerecycled Roestvrij Staal. Pen en Balpen. Jumbo Refill.

Ø 1 x 13.8 cm 100 / 25 Print Code: B(1), D(1), L1



New

AL
RECYCLED



Darma 20686

Set. Recycled Aluminium. Pen and Roller. Jumbo Refill.

Set. Recycling Aluminium. Kugelschreiber und Roller Pen. Jumbo Mine.

Set. Aluminium Recyclé. Stylo et Roller. Recharge Jumbo.

Set. Gerecycled Aluminium. Pen en Roller. Jumbo Refill.

Ø 1 x 14 cm 100 / 50 Print Code: B(1), D(1), L1



MADE FROM
-RECYCLED-
LEATHER



Vincen 1686

Set. Recycled Leather/ Metal. Pen and Roller. Jumbo Refill.

Set. Recycling Leder/ Metall. Kugelschreiber und Roller Pen. Jumbo Mine.

Set. Cuir Recyclé/ Métal. Stylo et Roller. Recharge Jumbo.

Set. Gerecycled Leer/ Metaal. Pen en Balpen. Jumbo Refill.

Ø 1 x 13.6 cm 100 / 25 Print Code: B(1), D(1), L1



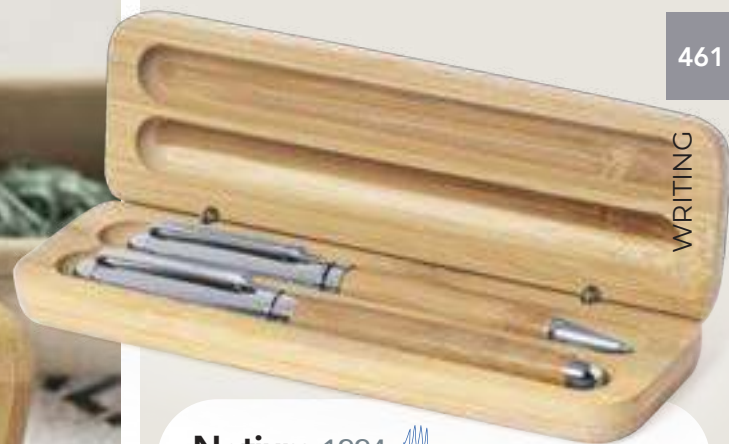

Notium 1224

Set. Bamboe/ Metaal. Pen and Roller. Jumbo Refill.
 Set. Bambou/ Métal. Kugelschreiber und Roller Pen. Jumbo Mine.
 Set. Bamboe/ Métal. Stylo et Roller. Recharge Jumbo.
 Set. Bamboe/ Metaal. Pen en Roller. Jumbo Refill.

 Ø 1.2 × 14.4 cm  100 / 50  Print Code: B(1), D(1), L1



Odegor 1223

Set. Cork/ Metal. Pen and Roller. Jumbo Refill.
 Set. Kork/ Métal. Kugelschreiber und Roller Pen. Jumbo Mine.
 Set. Liège/ Métal. Stylo et Roller. Recharge Jumbo.
 Set. Kurk/ Metaal. Pen en Roller. Jumbo Refill.

 Ø 1.1 × 13.4 cm  100 / 50  Print Code: B(1), D(1), L1





1 6

Xaba 16GB 1593

USB Stylus Touch Ball Pen. Aluminium. Jumbo Refill.
Kugelschreiber Pointer USB. Aluminium. Jumbo Mine.
Styllet Bille USB. Aluminium. Recharge Jumbo.
USB Touch-Screen Balpen. Aluminium. Jumbo Refill.

Ø 1.1 x 14.7 cm 200 / 50 Print Code: B(4), D(1), L1

PERMANENT STOCK



1 6

Rond 16GB 1614

USB Ball Pen. Jumbo Refill.
Kugelschreiber USB. Jumbo Mine.
Stylo USB. Recharge Jumbo.
USB Balpen. Jumbo Refill.

Ø 1.2 x 14.5 cm 200 / 50 Print Code: B(4), D(1)



07 02 19 04 05 11 03

1 6

Sivart 16GB 5849

USB Stylus Touch Ball Pen. Metal.
Kugelschreiber Pointer USB. Metall.
Styllet Bille USB. Métal.
USB Touch-Screen Balpen. Metaal.

Ø 1.4 x 14 cm 100 / 20
Print Code: D(1), B(4), L1



1 6

Kornon 16GB 1235

USB Ball Pen. Wood.
Kugelschreiber USB. Holz.
Stylo USB. Bois.
USB Balpen. Hout.

Ø 1.8 x 14.5 cm 200 / 20 Print Code: D(1), B(4), L1



Elegant Set

Okonel 21064

Set. Metal. Pen and Roller. Jumbo Refill.
 Set. Metall. Kugelschreiber und Roller Pen. Jumbo Mine.
 Set. Métal. Stylo et Roller. Recharge Jumbo.
 Set. Metaal. Pen en Roller. Jumbo Refill.

Ø 1.2 x 14 cm 100 / 50
 Print Code: D(1), L1



Williams 1277

Set. Metal. Pen and Roller. Jumbo Refill.
 Set. Metall. Kugelschreiber und Roller Pen. Jumbo Mine.
 Set. Métal. Stylo et Roller. Recharge Jumbo.
 Set. Metaal. Pen en Roller. Jumbo Refill.

Ø 1.1 x 13.7 cm 40 / 20 Print Code: D(1), L1



Yodel 5385

Pen. Metal. Jumbo Refill.
 Kugelschreiber. Metall. Jumbo Mine.
 Stylo. Métal. Recharge Jumbo.
 Pen. Metaal. Jumbo Refill.

Ø 1 x 14.1 cm 40 Print Code: D(1), L1



Darius 5384

Set. Metal. Pen and Roller. Jumbo Refill.
 Set. Metall. Kugelschreiber und Roller Pen. Jumbo Mine.
 Set. Métal. Stylo et Roller. Recharge Jumbo.
 Set. Metaal. Pen en Roller. Jumbo Refill.

Ø 1.3 x 14 cm 40 Print Code: D(1), L1



Niveum 1278

Set. PU/ Metal. Pen and Roller. Jumbo Refill.
 Set. PU/ Metall. Kugelschreiber und Roller Pen. Jumbo Mine.
 Set. Similicuir/ Métal. Stylo et Roller. Recharge Jumbo.
 Set. PU/ Metaal. Pen en Roller. Jumbo Refill.

Ø 1 x 13.6 cm 100 / 50 Print Code: D(1), L1





03



01

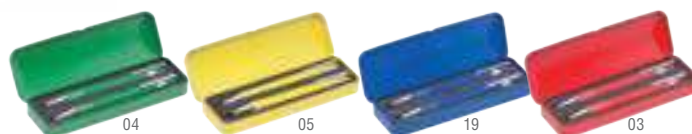

04

05

19

03

Bostit 21082

Set. Aluminium. Pen and Roller. Jumbo Refill.
 Set. Aluminium. Kugelschreiber und Roller Pen. Jumbo Mine.
 Set. Aluminium. Stylo et Roller. Recharge Jumbo.
 Set. Aluminium. Pen en Roller. Jumbo Refill.

Ø 1.1 x 15.2 cm 200 / 50
 Print Code: D(1), L1

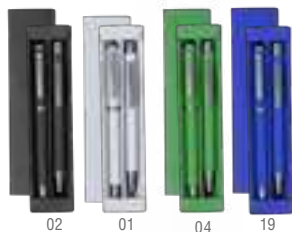

02

01

04

19

Sheridan 3338

Set. Aluminium. Jumbo Refill Pen. Mechanical Pencil; 0,7 mm Leads Included.
 Set. Aluminium. Kugelschreiber Jumbo Mine. Bleistift; Minen 0,7 mm Inklusiv.
 Set. Aluminium. Stylo Recharge Jumbo. Portemines; Mines 0,7 mm Incluses.
 Set. Aluminium. Jumbo Refill Pen. Vulpotlood; 0,7 mm Stiftees Inclusief.

Ø 1.1 x 13.2 cm 100 / 50 Print Code: B(1), D(1), L1



08



01



02

Lumix 4348

Set. Aluminium. Pen and Roller. Jumbo Refill.
 Set. Aluminium. Kugelschreiber und Roller Pen. Jumbo Mine.
 Set. Aluminium. Stylo et Roller. Recharge Jumbo.
 Set. Aluminium. Pen en Roller. Jumbo Refill.

Ø 1.1 x 14 cm 100 / 25 Print Code: B(4), D(1), L1



Dacox 4349

Pen. Metal. Jumbo Refill. Refill Included.
 Kugelschreiber. Metall. Jumbo Mine. Ersatzmine Inklusiv.
 Stylo. Métal. Recharge Jumbo. Recharge Inclusive.
 Pen. Metaal. Jumbo Refill. Refill Inclusief.

Ø 1.2 x 13.8 cm 100 / 25 Print Code: B(4), D(1), L1

**WHEAT
STRAW**

Bruneok 1245

Set. Bamboo/ Wheat Straw/ PP. Pen. Mechanical Pencil: 0,5 mm Leads Included.
 Set. Bambus/ Weizenstroh/ PP. Kugelschreiber. Bleistift: Minen 0,5 mm Inklusive.
 Set. Bamboo/ Paille de Blé/ PP. Stylo. Portemines: Mines 0,5 mm Inclusive.
 Set. Bamboe/ Tarwestro/ PP. Pen. Vulpotlood: 0,5 mm Stifjes Inclusief.

📏 Ø 1 x 14 cm 📦 300 / 25 ♻️ Print Code: B(4), D(1), L1

Onyx 20683

Set. Wheat Straw/ PP. Pen. Mechanical Pencil: 0,7 mm Leads Included.
 Set. Weizenstroh/ PP. Kugelschreiber. Bleistift: Minen 0,7 mm Inklusive.
 Set. Paille de Blé/ PP. Stylo. Portemines: Mines 0,7 mm Inclusive.
 Set. Tarwestro/ PP. Pen. Vulpotlood: 0,7 mm Stifjes Inclusief.

📏 Ø 1 x 14 cm 📦 200 / 100 ♻️ Print Code: B(4), D(1), L1



Harzur 1685

Set. Recycled Aluminium/ Recycled ABS. Pen and Roller. Jumbo Refill.
 Set. Recycling Aluminium/ Recycling ABS. Kugelschreiber und Roller Pen. Jumbo Mine.
 Set. Aluminium Recyclé/ ABS Recyclé. Stylo et Roller. Recharge Jumbo.
 Set. Gerecycled Aluminium/ Gerecycled ABS. Pen en Balpen. Jumbo Refill.

📏 Ø 1 x 13,8 cm 📦 100 / 25 ♻️ Print Code: B(4), D(1), L1



Proston 20684

Set. Coffee Fibre/ PP. 4 Pieces.
 Set. Kaffeefaser/ PP. 4 Stück.
 Set. Fibre de café/ PP. 4 Pièces.
 Set. Koffievezel/ PP. 4 Stuks.

📏 3,4 x 16,5 x 1,5 cm 📦 300 / 50 ♻️ Print Code: D(1), B(1), W





PARKER

Vector XL 7386

Urban Twist 7391

IM Essential 7387

Vector XL 7386

09 02

Roller. Stainless Steel. Jumbo Refill. Black Ink.
Roller Pen. Rostfreier Stahl. Jumbo Mine. Schwarze Tinte.
Roller. Acier Inox. Recharge Jumbo. Encre Noire.
Roller. Roestvrij Staal. Jumbo Refill. Zwarte Inkt.

Ø 1.2 × 13.5 cm 50 Print Code: D(4), L1

Urban Twist 7391

09 02

Pen. Metal. Jumbo Refill.
Kugelschreiber. Metall. Jumbo Mine.
Stylo. Métal. Recharge Jumbo.
Pen. Metaal. Jumbo Refill.

Ø 1.5 × 13.6 cm 50 Print Code: D(4), L1

IM Essential 7387

Roller. Metal. Jumbo Refill. Black Ink.
Roller Pen. Metall. Jumbo Mine. Schwarze Tinte.
Roller. Métal. Recharge Jumbo. Encre Noire.
Roller. Metaal. Jumbo Refill. Zwarte Inkt.

Ø 1.3 × 13.8 cm 50 Print Code: D(4), L1





PARKER



IM Achromatic 7388



IM Achromatic 7389



IM Achromatic 7390



IM Achromatic 7388

Pen. Stainless Steel. Jumbo Refill.
Kugelschreiber. Rostfreier Stahl. Jumbo Mine.
Stylo. Acier Inox. Recharge Jumbo.
Pen. Roestvrij Staal. Jumbo Refill.

Ø 1.1 x 13.5 cm 50 Print Code: D(4), L1



IM Achromatic 7389

Roller. Stainless Steel. Jumbo Refill. Black Ink.
Roller Pen. Rostfreier Stahl. Jumbo Mine. Schwarze Tinte.
Roller. Acier Inox. Recharge Jumbo. Encre Noire.
Roller. Roestvrij Staal. Jumbo Refill. Zwarte Inkt.

Ø 1.3 x 13.8 cm 50 Print Code: D(4), L1



IM Achromatic 7390

Fountain Pen. Stainless Steel. Jumbo Refill.
Füllfederhalter. Rostfreier Stahl. Jumbo Mine.
Stylo-Plume. Acier Inox. Recharge Jumbo.
Vulpen. Roestvrij Staal. Jumbo Refill.

Ø 1.3 x 13.8 cm 50 Print Code: D(4), L1





JOTTER RECYCLED



01

02

19

Jotter Recycled 7394

Pen. Recycled Stainless Steel/ Recycled ABS. Jumbo Refill. Black Ink.
 Kugelschreiber. Recycling Rostfreier Stahl/ Recycling ABS. Jumbo Mine. Schwarze Tinte.
 Stylo. Acier Inox Recyclé/ ABS Recyclé. Recharge Jumbo. Encre Noire.
 Pen. Gerecycled Roestvrij Staal/ Gerecycled ABS. Jumbo Refill. Zwarte Inkt.

UNEP Ø 1 x 12,9 cm 100 Print Code: D(4), L1



01

02

19

Jotter Recycled 7395

Pen. Recycled Stainless Steel/ Recycled ABS. Jumbo Refill.
 Kugelschreiber. Recycling Rostfreier Stahl/ Recycling ABS. Jumbo Mine.
 Stylo. Acier Inox Recyclé/ ABS Recyclé. Recharge Jumbo.
 Pen. Gerecycled Roestvrij Staal/ Gerecycled ABS. Jumbo Refill.

UNEP Ø 1 x 12,9 cm 100 Print Code: D(4), L1





PARKER

JOTTER

Original

Jotter Original 7382



02

01

Jotter Original 7382

Pen. Stainless Steel/ ABS. Jumbo Refill. Black Ink.
 Kugelschreiber. Rostfreier Stahl/ ABS. Jumbo Mine. Schwarze Tinte.
 Stylo. Acier Inox/ ABS. Recharge Jumbo. Encre Noire.
 Pen. Roestvrij Staal/ ABS. Jumbo Refill. Zwarte Inkt.

Ø 1 × 12.9 cm 100 Print Code: D(4), L1



Jotter Original 7383

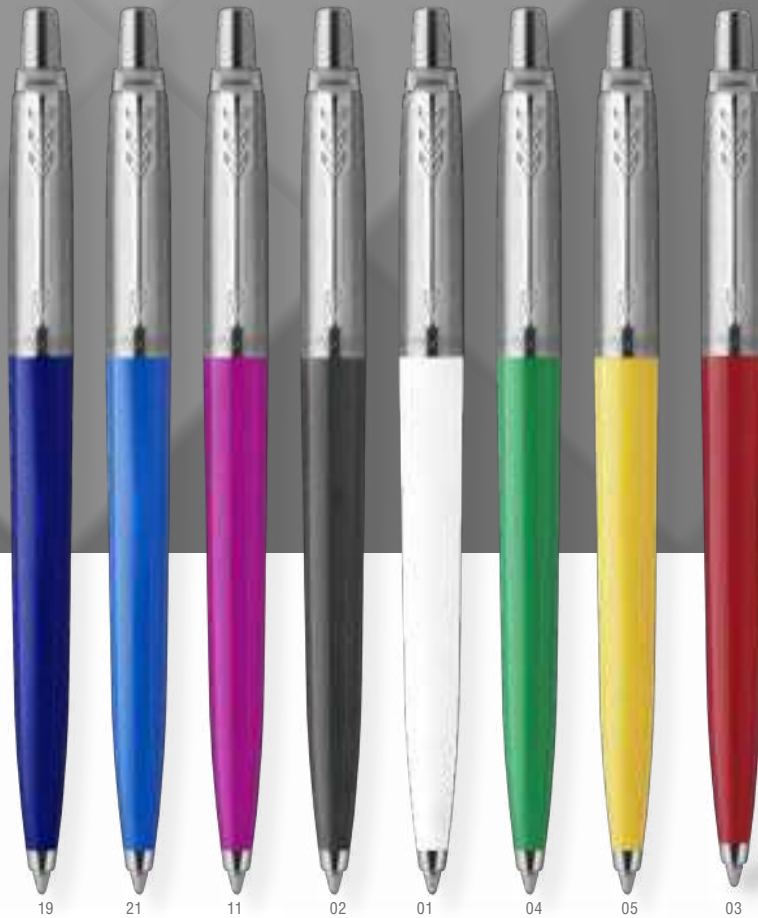

19

21

11

02

01

04

05

03

Jotter Original 7383

Pen. Stainless Steel/ ABS. Jumbo Refill.
 Kugelschreiber. Rostfreier Stahl/ ABS. Jumbo Mine.
 Stylo. Acier Inox/ ABS. Recharge Jumbo.
 Pen. Roestvrij Staal/ ABS. Jumbo Refill.

Ø 1 × 12.9 cm 100 Print Code: D(4), L1



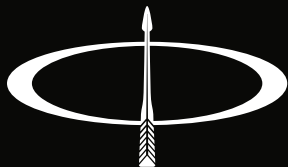

PARKER



Jotter Core 7384

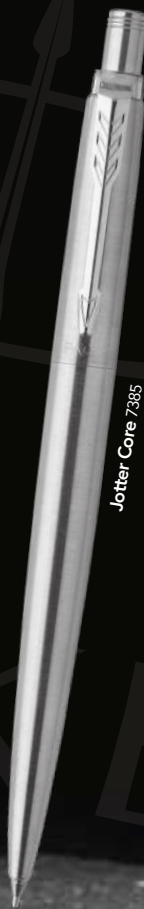

Jotter Core 7385

Jotter Core 7384

Pen, Stainless Steel. Jumbo Refill.
Kugelschreiber. Rostfreier Stahl. Jumbo Mine.
Stylo. Acier Inox. Recharge Jumbo.
Pen. Roestvrij Staal. Jumbo Refill.

Ø 1 x 13.8 cm 50 Print Code: D(4), L1



Jotter Core 7385

Mechanical Pencil, Stainless Steel, 0,5 mm Leads Included.
Mechanischer Bleistift. Rostfreier Stahl. Minen 0,5 mm Inklusiv.
Portemines. Acier Inox. Mines 0,5 mm Inclusives.
Vulpotlood. Roestvrij Staal. 0,5 mm Stijfjes Inclusief.

Ø 1 x 13.8 cm 50 Print Code: D(4), L1





09

02



Lierok 32GB 7378

USB Ball Pen. Metal/ ABS.
Kugelschreiber USB. Metall/ ABS.
Stylo USB. Métal/ ABS.
USB Balpen. Metaal/ ABS.

Ø 1.3 × 14.5 cm 200 / 50 Print Code: D(4), L1

32GB



Latrex 32GB 7359

USB Stylus Touch Ball Pen. Metal. Black Ink.
Kugelschreiber Pointer USB. Metall. Schwarze Tinte.
Stylet Bille USB. Métal. Encre Noir.
USB Touch-Screen Balpen. Metaal. Zwarte Inkt.

Ø 1.4 × 13.8 cm 100 / 20 Print Code: D(4), L1

32GB



Tengluk 7370

Set. Metal. Pen and Roller. Jumbo Refill.
Set. Metall. Kugelschreiber und Roller Pen. Jumbo Mine.
Set. Métal. Stylo et Roller. Recharge Jumbo.
Set. Metaal. Pen en Balpen. Jumbo Refill.

Ø 1.1 × 13.3 cm 100 / 50
Print Code: D(4), L1



Fakul 7371

Roller. Metal. Jumbo Refill.
Roller Pen. Metall. Jumbo Mine.
Roller. Métal. Recharge Jumbo.
Roller. Metaal. Jumbo Refill.

Ø 1.1 × 13.5 cm 100 / 50
Print Code: D(4), L1



09

02

Gordon 7372

Pen. Metal.
Kugelschreiber. Metall.
Stylo. Métal.
Pen. Metaal.

Ø 1 × 13.6 cm 100 / 50
Print Code: D(4), L1



08

ANTONIO MIRO



Antonio Miró is currently a benchmark in the increasingly demanding fashion industry. Worldwide renowned and consolidated in showcases such as Paris, Milan, New York and Tokyo, with prestige earned by collections based on simplicity and perfection, being these his personal hallmarks. Minimalist like few others, Antonio Miró devotes his success to elegance, an objective he has never renounced.



Helox 7166

Roller. Metal. Jumbo Refill.
Roller Pen. Metall. Jumbo Mine.
Roller. Métal. Recharge Jumbo.
Roller. Metaal. Jumbo Refill.

Ø 1.3 x 13.8 cm 100 / 25 Print Code: D(4), L1

Dayo 7163

Pen. Metal. Jumbo Refill.
Kugelschreiber. Metall. Jumbo Mine.
Stylo. Métal. Recharge Jumbo.
Pen. Metaal. Jumbo Refill.

Ø 1.3 x 13.5 cm 100 / 25 Print Code: D(4), L1



Helmor 7335

Pen. Aluminium.
Kugelschreiber. Aluminium.
Stylo. Aluminium.
Pen. Aluminium.

Ø 1 x 14 cm 200 / 50 Print Code: D(4), L1



02



Nilka 7294

Set. Metal. Pen and Roller.
Set. Metall. Kugelschreiber und Roller Pen.
Set. Métal. Stylo et Roller.
Set. Metaal. Pen en Roller.

Ø 1.2 x 14.1 cm 100 / 50 Print Code: D(4), L1





Norey 7311

Stylus Touch Ball Pen. Metal. Jumbo Refill.
Kugelschreiber Pointer. Metall. Jumbo Mine.
Stylét Bille. Métal. Recharge Jumbo.
Touch-Screen Balpen. Metaal. Jumbo Refill.

Ø 1.1 x 14 cm 200 / 100 Print Code: L1



Yago 7160

Stylus Touch Ball Pen. Metal.
Kugelschreiber Pointer. Metall.
Stylét Bille. Métal.
Touch-Screen Balpen. Metaal.

Ø 1 x 14 cm 200 / 100 Print Code: D(4), L1



The Italian designer Alexluca has earned a place among the leading trend designers by means of well-worked proposals. This new and exclusive collection of gifts has been developed with the most demanding companies in mind. Alexluca brand items always come with an added value of style, elegance and design, guaranteeing the satisfaction of those who receive them.

Alexluca
Italy

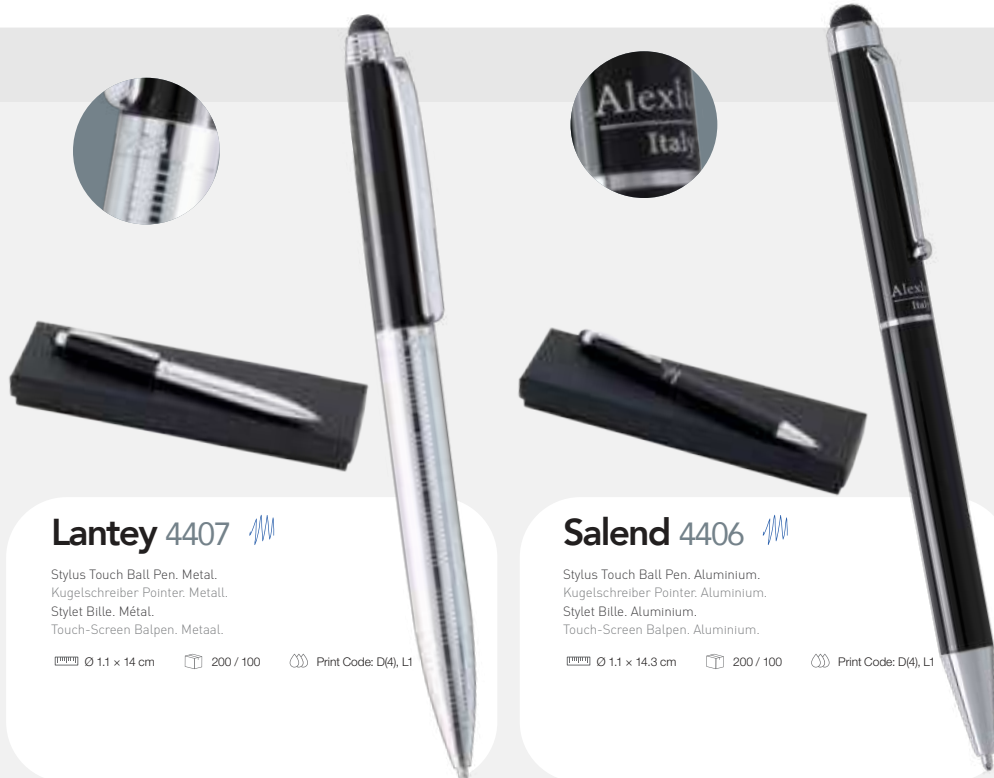

Lantey 4407

Stylus Touch Ball Pen. Metal.
Kugelschreiber Pointer. Metall.
Stylét Bille. Métal.
Touch-Screen Balpen. Metaal.

Ø 1.1 x 14 cm 200 / 100 Print Code: D(4), L1

Salend 4406

Stylus Touch Ball Pen. Aluminium.
Kugelschreiber Pointer. Aluminium.
Stylét Bille. Aluminium.
Touch-Screen Balpen. Aluminium.

Ø 1.1 x 14.3 cm 200 / 100 Print Code: D(4), L1



02 09 01 03 04 05 07 11 19

Zardox 5255

Pen. Aluminium.
Kugelschreiber. Aluminium.
Stylo. Aluminium.
Pen. Aluminium.

! +5.000 uds
PRINTING 12% Dto.

Ø 0.8 × 12.9 cm 1000 / 50 Print Code: B(4), L1



23



22 02 01 09

Mulent 6019

Stylus Touch Ball Pen. Aluminium.
Kugelschreiber Pointer. Aluminium.
Styler Bille. Aluminium.
Touch-Screen Balpen. Aluminium.

Ø 0.9 × 14.1 cm 500 / 50 Print Code: B(4), L1



23



01 02 04 05 07 11 19

! +5.000 uds
PRINTING 12% Dto.

Minox 3960

Stylus Touch Ball Pen. Aluminium.
Kugelschreiber Pointer. Aluminium.
Styler Bille. Aluminium.
Touch-Screen Balpen. Aluminium.

Ø 0.9 × 12.5 cm 1000 / 50
Print Code: B(4), L1



03



19 01 04 05 07 03 11

! +5.000 uds
PRINTING 12% Dto.

Byzar 4660

Stylus Touch Ball Pen. Aluminium.
Kugelschreiber Pointer. Aluminium.
Styler Bille. Aluminium.
Touch-Screen Balpen. Aluminium.

Ø 0.7 × 13.7 cm 1000 / 50 Print Code: B(4), L1



02



02 16 05 03

Duser 5575

Stylus Touch Ball Pen. Aluminium.
Kugelschreiber Pointer. Aluminium.
Styler Bille. Aluminium.
Touch-Screen Balpen. Aluminium.

Ø 0.7 × 13.7 cm 1000 / 50
Print Code: B(4), L1



19

NEW
COLORS

01 02 03 04 09 07 08 11 23 06 21 16

Trocum 5418

Pen. Aluminium. Jumbo Refill.
Kugelschreiber. Aluminium. Jumbo Mine.
Stylo. Aluminium. Recharge Jumbo.
Pen. Aluminium. Jumbo Refill.

Ø 1 x 13.7 cm 500 / 50 Print Code: B(4), L1

19

New



08 02 04 09 19

Mafei 20668

Pen. Aluminium.
Kugelschreiber. Aluminium.
Stylo. Aluminium.
Pen. Aluminium.

Ø 1 x 13.9 cm 500 / 50 Print Code: B(1), L1

03



11 03 07 21 19 01 09 02 23

Mitch 5121

Stylus Touch Ball Pen. Aluminium. Jumbo Refill.
Kugelschreiber Pointer. Aluminium. Jumbo Mine.
Stylo Bille. Aluminium. Recharge Jumbo.
Touch-Screen Balpen. Aluminium. Jumbo Refill.

Ø 1 x 13.9 cm 500 / 50
Print Code: B(4), L1

04

New



08 02 03 04 19 09

Suton 20669

Roller. Aluminium. Jumbo Refill.
Roller Pen. Aluminium. Jumbo Mine.
Roller. Aluminium. Recharge Jumbo.
Roller. Aluminium. Jumbo Refill.

Ø 1.1 x 13.5 cm 500 / 50
Print Code: B(1), L1

New



09 02 06



23

Uplex 21118

Holder Pen. Aluminium.
Kugelschreiber Halter. Aluminium.
Stylo Support. Aluminium.
Pen-Houder. Aluminium.

Ø 1.1 x 14 cm 1000 / 50
Print Code: B(1), L1



02 03 04 05 13 19

Latif 20671

Pen. Wheat Straw/ ABS.
Kugelschreiber. Weizenstroh/ ABS.
Stylo. Paille de Blé/ ABS.
Pen. Tarwestro/ ABS.

1,2 x 14,4 x 1 cm 1000 / 50
Print Code: A(4)

New



07



13 07 03 05 04

! +10.000 uds
PRINTING 12% Dto.

Rosdy 6334

Pen. Wheat Straw/ ABS.
Kugelschreiber. Weizenstroh/ ABS.
Stylo. Paille de Blé/ ABS.
Pen. Tarwestro/ ABS.

1 x 14,5 cm 1000 / 50
Print Code: A(4)



19



02 13 19 04

Lileo 20228

Pen. Wheat Straw/ ABS.
Kugelschreiber. Weizenstroh/ ABS.
Stylo. Paille de Blé/ ABS.
Pen. Tarwestro/ ABS.

0,8 x 14,2 cm 1000 / 50
Print Code: A(4)

New



03

New



02 04 05 07 13 19

! +10.000 uds
PRINTING 12% Dto.

Peters 21127

Pen. Wheat Straw/ ABS.
Kugelschreiber. Weizenstroh/ ABS.
Stylo. Paille de Blé/ ABS.
Pen. Tarwestro/ ABS.

0,9 x 13,9 cm 1000 / 50
Print Code: A(4)



03



03 04 19

Radun 6567

Mini Pen. Wheat Straw/ ABS.
Mini Kugelschreiber. Weizenstroh/ ABS.
Mini Stylo. Paille de Blé/ ABS.
Minipen. Tarwestro/ ABS.

1 x 9,2 cm 2000 / 50 Print Code: A(4), W



13

Yusin 6937

Pen. Bamboo/ Wheat Straw/ PP.
Kugelschreiber. Bambus/ Weizenstroh/ PP.
Stylo. Bambou/ Paille de Blé/ PP.
Pen. Bamboe/ Tarwestro/ PP.

1 x 14 cm 1000 / 50
Print Code: B(4), L1





13 07 03 02 19



+10.000 uds
PRINTING 12% Dto.

Harry 6772

Pen. Wheat Straw/ PP.
Kugelschreiber. Weizenstroh/ PP.
Stylo. Paille de Blé/ PP.
Pen. Tarwestro/ PP.

Ø 1 x 14 cm 1000 / 50
Print Code: A(4)



04

WHEAT
STRAW



02 03 05 07 13 19



+10.000 uds
PRINTING 12% Dto.

Wipper 6605

Pen. Wheat Straw/ ABS.
Kugelschreiber. Weizenstroh/ ABS.
Stylo. Paille de Blé/ ABS.
Pen. Tarwestro/ ABS.

Ø 1 x 13.8 cm 1000 / 50
Print Code: A(4)



04



13 19 07 04 03



+10.000 uds
PRINTING 12% Dto.

Prodox 6213

Pen. Wheat Straw/ ABS. Jumbo Refill.
Kugelschreiber. Weizenstroh/ ABS. Jumbo Mine.
Stylo. Paille de Blé/ ABS. Recharge Jumbo.
Pen. Tarwestro/ ABS. Jumbo Refill.

Ø 1.3 x 14 cm 1000 / 50
Print Code: A(4)



05



13 07 03 05 19



+10.000 uds
PRINTING 12% Dto.

Nukot 6335

Pen. Wheat Straw/ ABS. Jumbo Refill.
Kugelschreiber. Weizenstroh/ ABS. Jumbo Mine.
Stylo. Paille de Blé/ ABS. Recharge Jumbo.
Pen. Tarwestro/ ABS. Jumbo Refill.

Ø 1 x 13.7 cm 1000 / 50
Print Code: A(4)



04



New

Kinun 20672

Pen. Wheat Straw/ ABS. Marker Included.
Kugelschreiber. Weizenstroh/ ABS. Textmarker Inklusiv.
Stylo. Paille de Blé/ ABS. Marqueur Inclusif.
Pen. Tarwestro/ ABS. Marker Inclusief.

Ø 1.4 x 14.6 cm 1000 / 50
Print Code: A(4)

R ABS RECYCLED ABS



01 03 04 19

Storm 21125

Pen. Recycled ABS/ Bamboo. Jumbo Refill.
Kugelschreiber. Recycling ABS/ Bambus. Jumbo Mine.
Stylo. ABS Recyclé/ Bambou. Recharge Jumbo.
Pen. Gerecycled ABS/ Bamboe. Jumbo Refill.

Ø 1.2 x 14.3 cm 1000 / 50
Print Code: B(1), L1



New

02



01 19 04 02

Synex 20673

Pen. Recycled ABS.
Kugelschreiber. Recycling ABS.
Stylo. ABS Recyclé.
Pen. Gerecycled ABS.

Ø 1 x 14.5 cm 1000 / 50 Print Code: A(4)



New

03



03 07 04 02 01

Caleb 20187

Pen. Recycled ABS.
Kugelschreiber. Recycling ABS.
Stylo. ABS Recyclé.
Pen. Gerecycled ABS.

Ø 1.1 x 14.1 cm 1000 / 50 Print Code: A(4)

New

19



19 07 04 02 01

Budox 20186

Pen. Recycled ABS.
Kugelschreiber. Recycling ABS.
Stylo. ABS Recyclé.
Pen. Gerecycled ABS.

Ø 1 x 14 cm 1000 / 50 Print Code: A(4)

New

03



! +10.000 uds
PRINTING 12% Dto.



RPET



04 19 01

Surten 20675

Pen. RPET.
Kugelschreiber. RPET.
Stylo. RPET.
Pen. RPET.

Ø 1.1 x 13.8 cm 1000 / 50
Print Code: A(4)

New



03

! +10.000 uds
PRINTING 12% Dto.



02 04 07 19 01

Groslin 20674

Pen. RPET.
Kugelschreiber. RPET.
Stylo. RPET.
Pen. RPET.

Ø 1 x 14.1 cm 1000 / 50
Print Code: A(4)

New



03



01 04 03 02

Lester 1290

Pen. RPET.
Kugelschreiber. RPET.
Stylo. RPET.
Pen. RPET.

Ø 1 x 14.7 cm 1000 / 50
Print Code: B(4)



19



01 03 19

Hispar 6731

Pen. RPET.
Kugelschreiber. RPET.
Stylo. RPET.
Pen. RPET.

Ø 1 x 13.6 cm 1000 / 50
Print Code: A(4)



04



01 02 04 19

Dontiox 20287

Pen. RPET.
Kugelschreiber. RPET.
Stylo. RPET.
Pen. RPET.

Ø 1.1 x 13.9 cm 1000 / 50
Print Code: A(4)

New



03



02

04

19

05

! +10.000 uds
PRINTING 12% Dto.

01

03

Licter 6659

Antibacterial Pen.
Antibakteriell Kugelschreiber.
Stylo Antibacterienne.
Antibacterieel Pen.

Ø 1 x 13.8 cm 1000 / 50 Print Code: B(4)



! +10.000 uds
PRINTING 12% Dto.

Flom 6640

Antibacterial Pen.
Antibakteriell Kugelschreiber.
Stylo Antibacterienne.
Antibacterieel Pen.

Ø 1.3 x 14 cm 1000 / 50
Print Code: B(4)



! +10.000 uds
PRINTING 12% Dto.

Ramix 6692

Antibacterial Pen.
Antibakteriell Kugelschreiber.
Stylo Antibacterienne.
Antibacterieel Pen.

Ø 1.1 x 14 cm 1000 / 50
Print Code: B(4)



3 ml

LIQUID NOT INCLUDED/
REFILLABLE

ANTIBACTERIAL
FORMULA

Yak 6656

Multifunction Antibacterial Pen. 3 ml. Liquid Not Included.
Multifunktion Antibakteriell Kugelschreiber. 3 ml. Flüssigkeit Nicht im Lieferumfang.
Stylo Antibacterienne Multifonction. 3 ml. Liquide Non Inclusive.
Multifunctioneel Antibacterieel Balpen. 3 ml. Vloeistof Niet Inclusief.

Ø 1.4 x 15.7 cm 1000 / 50 Print Code: B(4)



Doret 6721

Antibacterial Pen. Thermometer Function.
Antibakteriell Kugelschreiber. Thermometer Funktion.
Stylo Antibacterienne. Fonction Thermomètre.
Antibacterieel Pen. Thermometer Functie.

Ø 1.1 x 14.5 cm 1000 / 50 Print Code: B(4)

BODY
TEMPERATURE



Lecon 20677

Pen. 2 Ink Colours and Mechanical Pencil. 0,7 mm Lead Included.

Kugelschreiber. 2 Farben Tinte und Bleistift. Mine 0,7 mm Inklusive.

Stylo. Écriture 2 Couleurs et Portemines. Mine 0,7 mm Incluse.

Pen. 2 Kleuren Inkt en Vulpotlood. 0,7 mm Stiftpje Inclusief.

Ø 1.1 x 14.5 cm 1000 / 50 Print Code: B(4)

! +10.000 uds
PRINTING 12% Dto.



Betsi 5120

Stylus Touch Ball Pen. 3 Ink Colours.

Kugelschreiber Pointer. 3 Farben Tinte.

Stylo Bille. Écriture 3 Couleurs.

Touch-Screen Balpen. 3 Kleuren Inkt.

Ø 1.1 x 14.8 cm 500 / 50
Print Code: A(4)

! +10.000 uds
PRINTING 12% Dto.



Milok 20676

Stylus Touch Ball Pen. ABS/ Bamboo. 3 Ink Colours.

Kugelschreiber Pointer. ABS/ Bambus. 3 Farben Tinte.

Stylo Bille. ABS/ Bambou. Écriture 3 Couleurs.

Touch-Screen Balpen. ABS/ Bamboe. 3 Kleuren Inkt.

Ø 1.1 x 14.8 cm 500 / 50
Print Code: B(4), L1



Multifour 3131

Pen. 4 Ink Colours.
Kugelschreiber. 4 Farben Tinte.

Stylo. Écriture 4 Couleurs.

Pen. 4 Kleuren Inkt.

Ø 1.2 x 14 cm 1000 / 50
Print Code: A(4)



Kiviuk 21085

Pen. 8 Ink Colours.

Kugelschreiber. 8 Farben Tinte.

Stylo. Écriture 8 Couleurs.

Pen. 8 Kleuren Inkt.

Ø 1.6 x 14 cm 500 / 100
Print Code: A(4)



! +10.000 uds
PRINTING 12% Dto.



Clessin 6336

Pen. 4 Ink Colours.

Kugelschreiber. 4 Farben Tinte.

Stylo. Écriture 4 Couleurs.

Pen. 4 Kleuren Inkt.

Ø 1.3 x 14.1 cm 1000 / 50
Print Code: A(4)



ROLLER PEN

WRITING



06 02 03 01



05

Leyco 4096

Roller. Jumbo Refill.
Roller Pen. Jumbo Mine.
Roller. Recharge Jumbo.
Roller. Jumbo Refill.

Ø 1.1 × 13.5 cm 1000 / 50 Print Code: B(4)



08 02



06

Bandax 1727

Roller. Jumbo Refill.
Roller Pen. Jumbo Mine.
Roller. Recharge Jumbo.
Roller. Jumbo Refill.

Ø 1.3 × 14 cm 1000 / 50 Print Code: L1



01 02 04 17 19 05

! +10.000 uds
PRINTING 12% Dto.

Kasty 6350

Roller. Jumbo Refill.
Roller Pen. Jumbo Mine.
Roller. Recharge Jumbo.
Roller. Jumbo Refill.

Ø 1 × 14.5 cm 1000 / 50 Print Code: A(4)



03

New

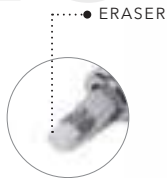

ERASER

Hadobex 21086

Mechanical Pencil. 0,7 mm Leads Included.
Mechanischer Bleistift. Minen 0,7 mm Inklusiv.
Portemines. Mines 0,7 mm Inclusives.
Vulpotlood. 0,7 mm Stiftjes Inclusief.

Ø 0.9 × 14.1 cm 1000 / 100
Print Code: A(1)



New

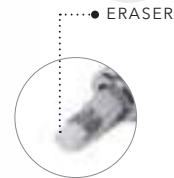

ERASER

Sofin 21183

Mechanical Pencil. Bamboo. 0,7 mm Leads Included.
Mechanischer Bleistift. Bambus. Minen 0,7 mm Inklusiv.
Portemines. Bamboe. Mines 0,7 mm Inclusives.
Vulpotlood. Bamboe. 0,7 mm Stiftjes Inclusief.

Ø 1.1 × 13.7 cm 1000 / 50
Print Code: B(4), L1



New

Binefar 21087

Mechanical Pencil. 0,7 mm Leads Included.
Mechanischer Bleistift. Minen 0,7 mm Inklusiv.
Portemines. Mines 0,7 mm Inclusives.
Vulpotlood. 0,7 mm Stiftjes Inclusief.

Ø 0.9 × 14 cm 1000 / 100
Print Code: A(1)



Mechanical Pencil



01 02 04 05 19

! +10.000 uds
PRINTING 12% Dto.

Vianox 21117

Pen.
Kugelschreiber.
Stylo.
Pen.

Ø 1 x 13.6 cm 1000 / 50
Print Code: A(4)



03



02 09 04 05 07 03 11

! +10.000 uds
PRINTING 12% Dto.

Sagur 4037

Stylus Touch Ball Pen.
Kugelschreiber Pointer.
Stylo Bille.
Touch-Screen Balpen.

Ø 1 x 13.5 cm 1000 / 50
Print Code: A(4)



19



07 01 02 04 19

! +10.000 uds
PRINTING 12% Dto.

Zadron 20657

Stylus Touch Ball Pen. ABS/ Bamboe.
Kugelschreiber Pointer. ABS/ Bambus.
Stylo Bille. ABS/ Bamboe.
Touch-Screen Balpen. ABS/ Bamboe.

Ø 1 x 13.5 cm 1000 / 50
Print Code: A(1), L1



03



07 05 04 19 11 02 01

! +10.000 uds
PRINTING 12% Dto.

Yomil 6073

Pen. Jumbo Refill.
Kugelschreiber. Jumbo Mine.
Stylo. Recharge Jumbo.
Pen. Jumbo Refill.

Ø 1 x 13.7 cm 1000 / 50
Print Code: B(4)



03



01 02 03 04 05 07

Parlex 6346

Stylus Touch Ball Pen. Jumbo Refill.
Kugelschreiber Pointer. Jumbo Mine.
Stylo Bille. Recharge Jumbo.
Touch-Screen Balpen. Jumbo Refill.

Ø 1 x 14.5 cm 1000 / 50
Print Code: A(4)



19



03 19 04 05 07

! +10.000 uds
PRINTING 12% Dto.

Laury 20224

Pen. Jumbo Refill.
Kugelschreiber. Jumbo Mine.
Stylo. Recharge Jumbo.
Pen. Jumbo Refill.

Ø 1 x 13.7 cm 1000 / 50
Print Code: A(4)



02



02

09

04

05

07

03

11

SCREEN
CLEANER

Finex 4972

Holder Pen. Black Ink. Screen Cleaner Included.
Kugelschreiber Halter. Schwarze Tinte. Displayreiner Inklusive.
Stylo Support. Encre Noire. Nettoyeur d'Écran Inclusif.
Pen-Houder. Zwarte Inkt. Screen Cleaner Inclusief.

Ø 1.1 × 14.6 cm 1000 / 50 Print Code: A(4)



19



02

03

19

04



Polus 20229

Holder Pen. Wheat Straw/ ABS.
Kugelschreiber Halter. Weizenstroh/ ABS.
Stylo Support. Paille de Blé/ ABS.
Pen-Houder. Tarwestro/ ABS.

Ø 1.2 × 14.5 cm 1000 / 50 Print Code: A(4)

New



13



19

02

01



ERASABLE INK

Ludrick 20150

Erasable Pen. Jumbo Refill.
Radierbarer Kugelschreiber. Jumbo Mine.
Stylo Effaçable. Recharge Jumbo.
Uitwisbare Pen. Jumbo Refill.

Ø 1.2 × 14.5 cm 1000 / 50
Print Code: A(4)



03



04

09

01

19

02

Alfil 5926

Stylus Touch Ball Pen.
Kugelschreiber Pointer.
Stylét Bille.
Touch-Screen Balpen.

Ø 0.8 × 13.2 cm 1000 / 50
Print Code: A(4)

! +10.000 uds
PRINTING 12% Dto.



03

Horten 3861

Pen. Jumbo Refill.
Kugelschreiber. Jumbo Mine.
Stylo. Recharge Jumbo.
Pen. Jumbo Refill.

Ø 1.1 × 14.2 cm 1000 / 50
Print Code: A(4)





Jeans 1674

Pen. Jumbo Refill.
Kugelschreiber. Jumbo Mine.
Stylo. Recharge Jumbo.
Pen. Jumbo Refill.

Ø 1.1 x 14.5 cm 1000 / 50
Print Code: B(4)



03



Yatson 20679

Pen.
Kugelschreiber.
Stylo.
Pen.

1.2 x 14.4 x 1 cm 1000 / 50 Print Code: A(4)

New

03



Klinch 3958

Pen.
Kugelschreiber.
Stylo.
Pen.

Ø 1.1 x 14.7 cm 1000 / 50 Print Code: A(4), W

! +10.000 uds
PRINTING 12% Dto.



05



Hurban 5574

Pen.
Kugelschreiber.
Stylo.
Pen.

Ø 1.1 x 14 cm 1000 / 50 Print Code: A(4)

! +10.000 uds
PRINTING 12% Dto.



05



02 04 21 16 05 07 03 11 01

Clexton 5014

! +10.000 uds
PRINTING 12% Dto.

Pen.
Kugelschreiber.
Stylo.
Pen.

Ø 1.3 x 14 cm 1000 / 50 Print Code: A(4)



19



21 19 01 02 04 05 07 11

Skipper 21126

! +10.000 uds
PRINTING 12% Dto.

Pen.
Kugelschreiber.
Stylo.
Pen.

Ø 0.9 x 13.9 cm 1000 / 50 Print Code: A(4)

New



03



02 03 21 05 07 11 19

Tinkin 6074

! +10.000 uds
PRINTING 12% Dto.

Pen.
Kugelschreiber.
Stylo.
Pen.

Ø 1.3 x 14 cm 1000 / 50 Print Code: A(4)



04



02 01 19 04 05 07 11

Zeril 6075

! +10.000 uds
PRINTING 12% Dto.

Stylus Touch Ball Pen.
Kugelschreiber Pointer.
Stylolet Bille.
Touch-Screen Balpen.

Ø 1.3 x 14 cm 1000 / 50 Print Code: A(4)



03

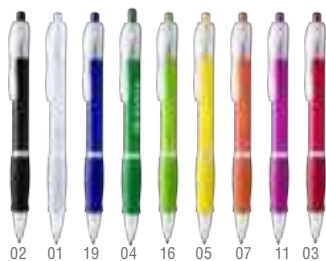

02 01 19 04 16 05 07 11 03

! +10.000 uds
PRINTING 12% Dto.

Zonet 3523

Pen.
Kugelschreiber.
Stylo.
Pen.

Ø 1 x 14,5 cm 1000 / 50
Print Code: A(4)

21



17 17 11 21 07 05 04 19 01 02

! +10.000 uds
PRINTING 12% Dto.

Blacks 5557

Pen.
Kugelschreiber.
Stylo.
Pen.

Ø 1 x 13,8 cm 1000 / 50
Print Code: A(4)

03



21 19 02 01 05 07 04 11

! +10.000 uds
PRINTING 12% Dto.

Xylander 21084

Pen.
Kugelschreiber.
Stylo.
Pen.

Ø 1 x 14,2 cm 1000 / 50
Print Code: A(4)

03



New



21 17 02 01 11 04 05 07 03

Zufer 4345

! +10.000 uds
PRINTING 12% Dto.

Pen.
Kugelschreiber.
Stylo.
Pen.

Ø 1 x 14,5 cm 1000 / 50
Print Code: A(4)

19



02 03 04 05 07 19 17

Kific 6410

! +10.000 uds
PRINTING 12% Dto.

Pen.
Kugelschreiber.
Stylo.
Pen.

Ø 1 x 13,8 cm 1000 / 50
Print Code: A(4)

11





MINI PEN

Hall 3147

Mini Pen.
Mini Kugelschreiber.
Mini Stylo.
Minipen.

01

Ø 1 x 9.6 cm 2000 / 100 Print Code: A(4), W

CARIOCA
Made in Italy



Universal 2469

Pen.
Kugelschreiber.
Stylo.
Pen.

Ø 0.8 x 14.5 cm 1200 / 50
Print Code: Consultar



03



Ricen 1671

Pen. Gel Ink.
Kugelschreiber. Gel Tinte.
Stylo. Encre Gel.
Pen. Gel Inkt.

Ø 1 x 14.8 cm 1000 / 50
Print Code: A(4)

Gel Ink



19



Elky 4355

Pen.
Kugelschreiber.
Stylo.
Pen.

Ø 0.8 x 14.6 cm 2000 / 50
Print Code: Consultar



03



09 01 02 03

Sauris 4402

5 in 1
MULTI-FUNCTION

Multifunction Pen. 1 Accessorie. 5 Functions.
Multifunktion Kugelschreiber. 1 Teil. 5 Funktionen.
Stylo Multifonction. 1 Accessoire. 5 Fonctions.
Multifunctioneel Pen. 1 Accessoire. 5 Functies.

Ø 1 x 14.9 cm 1000 / 50
Print Code: B(4)



19



09 04 02 03

Payro 5791

7 in 1
MULTI-FUNCTION

7 in 1 Multifunction Pen. 1 Accessorie. 7 Functions.
7 in 1 Multifunktion Kugelschreiber. 1 Teil. 7 Funktionen.
Stylo Multifonction 7 en 1. 1 Accessoire. 7 Fonctions.
7 in 1 Multifunctioneel Pen. 1 Accessoire. 7 Functies.

1.6 x 15.5 x 1.2 cm 500 / 50
Print Code: B(4)



19



Gobit 20749

4 in 1
MULTI-FUNCTION

Cleaner Pen. 4 Functions.
Reinigungs Kugelschreiber. 4 Funktionen.
Stylo Nettoyeur. 4 Fonctions.
Reinigings Pen. 4 Functies.

Ø 1.2 x 14 cm 400 / 100
Print Code: B(4)

02

01



Contal 5119

3 in 1
MULTI-FUNCTION

Multifunction Pen. 3 Functions.
Multifunktion Kugelschreiber. 3 Funktionen.
Stylo Multifonction. 3 Fonctions.
Multifunctioneel Pen. 3 Functies.

Ø 1.1 x 14.8 cm 1000 / 50
Print Code: B(4)

3 in 1



6 in 1
MULTI-FUNCTION

Rakars 1581

Multifunction Pen. Bamboo. 1 Accessorie. 6 Functions.
Multifunktion Kugelschreiber. Bambus. 1 Teil. 6 Funktionen.
Stylo Multifonction. Bambou. 1 Accessoire. 6 Fonctions.
Multifunctioneel Pen. Bamboe. 1 Accessoire. 6 Functies.

Ø 1.2 x 15.1 cm 500 / 50
Print Code: B(4), L1

WOOD



Tulix 20504

8 in 1
MULTI-FUNCTION

Multifunction Pen. Stainless Steel. 1 Accessorie. 8 Functions.
Multifunktion Kugelschreiber. Rostfreier Stahl. 1 Teil. 8 Funktionen.
Stylo Multifonction. Acier Inox. 1 Accessoire. 8 Fonctions.
Multifunctioneel Pen. Roestvrij Staal. 1 Accessoire. 8 Functies.

1.3 x 16.3 x 1.3 cm 200 / 50
Print Code: C(1), L1

New



8 in 1

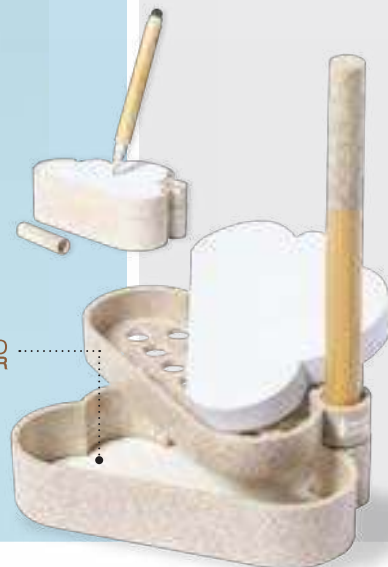

SEED PAPER

Lezo 1679

Seeds Notepad Holder. Wheat Straw/ ABS. 80 Sheets. Wildflowers. Bamboo Stylus Touch Ball Pen Included.

Samen Notizzettelbox. Weizenstroh/ ABS. 80 Blätter. Wilde Blumen. Bambus Kugelschreiber Pointer Inklusive.

Porte Notes Ensemencé. Paille de Blé/ ABS. 80 Feuilles. Fleurs Sauvages. Stylet Bille Bambou Incluse.

Zaad Notitieblokjezshouder. Tarwestro/ ABS. 80 Blaadjes. Wilde Bloemen. Bamboe Touch Bal Pen Inclusief.

10 x 14 x 6.5 cm 100 / 25 Print Code: D(1), L1



Mastor 1673

Pen. Bamboo. Adhesive Base.
Kugelschreiber. Bambus. Klebesocket.
Stylo. Bambou. Base Adhésive.
Pen. Bamboe. Zelfklevende Basis.

Ø 5.6 x 19 cm 200 / 50 Print Code: C(4), L1



Pontux 1227

Pen. Recycled Cardboard. Adhesive Base.
Kugelschreiber. Recycling Pappe. Klebesocket.
Stylo. Carton Recyclé. Base Adhésive.
Pen. Gerecycled Karton. Zelfklevende Basis.

Ø 5.3 x 15.5 cm 100 / 50 Print Code: C(4)





Medic 3708

Pen.
Kugelschreiber.
Stylo.
Pen.

 Ø 1.1 x 12.7 cm  1000 / 50  Print Code: B(4)

19



Tib 3715

Pen.
Kugelschreiber.
Stylo.
Pen.

 Ø 1.8 x 12 cm  1000 / 50  Print Code: B(4)



Tormil 6082

Pocket Protector. PVC.
Taschenschütz. PVC.
Protecteur de Poche. PVC.
Zakbeschermer. PVC.

 8.5 x 15 cm  1000 / 50
 Print Code: C(1)



Senter 3714

Pen Torch. 1 Led. Button Batteries Included.
Kugelschreiber Lampe. 1 Led. Knopfzellen Inklusive.
Stylo Lampe. 1 Led. Piles Bouton Incluses.
Pen-Zaklamp. 1 Led. Knooppcel Batterij Inclusief.

 Ø 1.5 x 12.7 cm  500 / 50  Print Code: B(4)



Velvex 4223

Pen Pouch. Velvet.
Kugelschreiber Hülle. Wildleder.
Étui Stylo. Suédine.
Pennehoes. Fluweel.

2.5 x 15.5 cm 8000 / 200 Print Code: B(1), N(8)



Recycard 3340

Pen Pouch. Recycled Cardboard.
Kugelschreiber Hülle. Recycling Pappe.
Étui Stylo. Carton Recyclé.
Pennehoes. Gerecycled Karton.

4 x 15.5 cm 4000 / 400 Print Code: B(4)

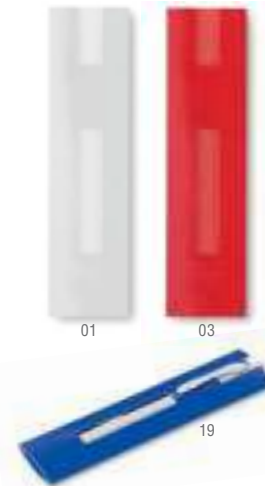

Menit 4222

Pen Pouch. Cardboard.
Kugelschreiber Hülle. Pappe.
Étui Stylo. Carton.
Pennehoes. Karton.

4 x 15.5 cm 4000 / 400 Print Code: B(4)



Locen 6611

Pen Pouch. Cardboard.
Kugelschreiber Hülle. Pappe.
Étui Stylo. Carton.
Pennehoes. Karton.

4 x 15.5 cm 4000 / 400 Print Code: B(4)



Brunia 1229

Pen Pouch. Cork.
Kugelschreiber Hülle. Kork.
Étui Stylo. Liège.
Pennehoes. Kurk.

4 x 16 cm 4000 / 400 Print Code: B(4), L1, N(8), W





Krujer 5035

Pen Torch. 1 Led. Button Batteries Included.
Kugelschreiber Lampe. 1 Led. Knopfzellen Inklusive.
Stylo Lampe. 1 Led. Piles Bouton Incluses.
Pen-Zaklamp. 1 Led. Knoopcel Batterijen Inclusief.

Ø 1 x 11 cm 500 / 50 Print Code: C(4)



Gradox 5735

Pen.
Kugelschreiber.
Stylo.
Pen.

Ø 2.3 x 17.5 cm 1000 / 50
Print Code: B(4)



Solek 5048

Felt Tip Pen. Magnetic.
Filzstift. Magnetisch.
Feutre. Magnétique.
Felt Tip Pen. Magnetisch.

Ø 1 x 11.4 cm 2000 / 50 Print Code: B(4)



Nicky 4707

Pen. Multicolour Led Lights. Button Batteries Included.
Kugelschreiber. Mehrfarbige Led Lichten. Knopfzellen Inklusive.
Stylo. Lumières Led Multicolores. Piles Bouton Incluses.
Pen. Meerkleurige Led Lichten. Knoopcel Batterijen Inclusief.

Ø 2.8 x 18.5 cm 500 / 50 Print Code: B(1)





Etesio 20970



Seeds Pencil. Wood. Pine Seeds Included.
Samen Bleistift. Holz. Piniensamen Inklusive.
Crayon Ensemencé. Bois. Graines de Pin Incluses.
Zaad Potlood. Hout. Pijnboom Zaden Inclusief.

Ø 0.7 × 17.5 cm 200 / 50
Print Code: B(4)

Tundra 9885



Pencil. Recycled Paper.
Bleistift. Recycling Papier.
Crayon. Papier Recyclé.
Potlood. Gerecycled Papier.

Ø 0.7 × 17.5 cm 2000 / 100
Print Code: A(4), W

Dengal 1276



Pencil. Recycled Paper.
Bleistift. Recycling Papier.
Crayon. Papier Recyclé.
Potlood. Gerecycled Papier.

Ø 0.7 × 17.5 cm 2000 / 100
Print Code: A(4), W

Recycled Cardboard

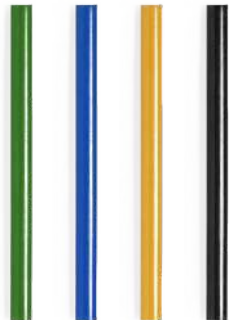

04 19 05 02

! +5.000 uds
PRINTING 12% Dto.

Miniature 9607



Pencil. Wood.
Bleistift. Holz.
Crayon. Bois.
Potlood. Hout.

Ø 0.5 × 10 cm 2000 / 100
Print Code: A(4), L1



04

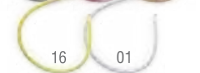

Carpintero 8876



Pencil. Wood.
Bleistift. Holz.
Crayon. Bois.
Potlood. Hout.

Ø 1.2 × 17.6 cm 1000 / 100
Print Code: A(1), L1, W



03

Ramsy 5440



Pencil. Wood.
Bleistift. Holz.
Crayon. Bois.
Potlood. Hout.

Ø 0.7 × 8.7 cm 3000 / 100
Print Code: A(4), L1



04

Flexi 3095



Pencil. PVC. Flexible.
Bleistift. PVC. Flexibel.
Crayon. PVC. Flexible.
Potlood. PVC. Flexibel.

Ø 0.6 × 32 cm 1000 / 100 Print Code: B(1)



! +10.000 uds
PRINTING 12% Dto.

Melart 5643



Pencil. Wood.
Bleistift. Holz.
Crayon. Bois.
Potlood. Hout.

Ø 0.7 × 18.6 cm 2000 / 100
Print Code: A(4), L1

21



! +10.000 uds
PRINTING 12% Dto.

Togi 4173



Pencil. Wood.
Bleistift. Holz.
Crayon. Bois.
Potlood. Hout.

Ø 0.7 × 19 cm 2000 / 100
Print Code: A(4), L1

04



! +10.000 uds
PRINTING 12% Dto.

Godiva 8587



Pencil. Wood.
Bleistift. Holz.
Crayon. Bois.
Potlood. Hout.

Ø 0.7 × 18.6 cm 2000 / 100
Print Code: A(4), L1

NEW COLOR

17



! +10.000 uds
PRINTING 12% Dto.

Krako 1933



Pencil. Wood.
Bleistift. Holz.
Crayon. Bois.
Potlood. Hout.

Ø 0.7 × 17.5 cm 2000 / 100
Print Code: A(1), L1

Nexio 1934



Pencil. Wood.
Bleistift. Holz.
Crayon. Bois.
Potlood. Hout.

Ø 0.7 × 19 cm 2000 / 100
Print Code: A(1), L1



! +10.000 uds
PRINTING 12% Dto.

Crespok 21088



Pencil. Wood.
Bleistift. Holz.
Crayon. Bois.
Potlood. Hout.

Ø 0.7 × 19 cm 2000 / 100
Print Code: A(4), L1

! +10.000 uds
PRINTING 12% Dto.

Vexor 20681



Pencil. Wood.
Bleistift. Holz.
Crayon. Bois.
Potlood. Hout.

Ø 0.7 × 10 cm 2000 / 100
Print Code: A(1), L1



New

New



03

05

19



04

Baby 9162

Set. Recycled Cardboard. 7 Pieces.
Set. Recycling Pappé. 7 Stück.
Set. Carton Recyclé. 7 Pièces.
Set. Gerecycled Karton. 7 Pottloden.

Ø 2.7 x 10.2 cm

400 / 50

Print Code: B(4), W



Boys 8584

Pencil Set. Recycled Cardboard. 12 Pencils.
Bleistiftbox. Recycling Pappé. 12 Stifte.
Boîte Crayons. Carton Recyclé. 12 Crayons.
Pottlood Set. Gerecycled Karton. 12 Pottloden.

9 x 9 x 1 cm

250 / 25

Print Code: B(4), W



Girls 8585

Pencil Set. Recycled Cardboard. 6 Pencils.
Bleistiftbox. Recycling Pappé. 6 Stifte.
Boîte Crayons. Carton Recyclé. 6 Crayons.
Pottlood Set. Gerecycled Karton. 6 Pottloden.

4.5 x 9 x 0.8 cm

500 / 25

Print Code: B(4)



Tynie 4456

Pencil Set. Recycled Cardboard. 4 Pencils.
Bleistiftbox. Recycling Pappé. 4 Stifte.
Boîte Crayons. Carton Recyclé. 4 Crayons.
Pottlood Set. Gerecycled Karton. 4 Pottloden.

3 x 9 x 0.8 cm

1000 / 50

Print Code: B(4)

Seed Paper

WRITING



Elaris 20372

Seeds Set. Seed Paper. 8 Pieces. 20 Sheets Notepad. Petunia Seeds Included. Assorted Coloured Flowers.

Samen Set. Samenpapier. 8 Stuk. 20 Blätter Notizblock. Petuniensamen Inklusief. In verschillende Farben.

Set Ensemencé. Papier Ensemencé. 8 Pièces. Bloc 20 Feuilles. Graines de Pétunia Incluses. Fleurs Couleurs Diverses.

Zaad Set. Zaadpapier. 8 Stuks. 20 Blaadjes Notepad. Petunia Zaden Inclusief. Assortiment van Gekleurde Bloemen.

7.4 x 9 x 1.5 cm 400 / 50 Print Code: B(4)



Fyser 20371

Seeds Crayon Set. Seed Paper. 6 Crayons. Petunia Seeds Included. Assorted Coloured Flowers.

Samen Wachsmalstifte Set. Samenpapier. 6 Wachsmalstifte. Petuniensamen Inklusief. In verschillende Farben.

Boîte Crayons Ensemencé. Papier Ensemencé. 6 Crayons. Graines de Pétunia Incluses. Fleurs Couleurs Diverses.

Zaad Wasco Set. Zaadpapier. 6 Krijtjes. Petunia Zaden Inclusief. Assortiment van Gekleurde Bloemen.

5.3 x 9 x 0.9 cm 250 / 25 Print Code: B(4)



Delar 20370

Seeds Pencil Set. Seed Paper. 6 Pencils. Petunia Seeds Included. Assorted Coloured Flowers.

Samen Bleistiftbox. Samenpapier. 6 Stifte. Petuniensamen Inklusief. In verschillende Farben.

Boîte Crayons Ensemencé. Papier Ensemencé. 6 Crayons. Graines de Pétunia Incluses. Fleurs Couleurs Diverses.

Zaad Potlood Set. Zaadpapier. 6 Potloden. Petunia Zaden Inclusief. Assortiment van Gekleurde Bloemen.

4.5 x 9 x 0.8 cm 500 / 25 Print Code: B(4)



Lameiro 21090

Pencil Set. Recycled Cardboard. 6 Pencils.

Bleistiftbox. Recycling Pappe. 6 Stifte.

Boîte Crayons. Carton Recyclé. 6 Crayons.

Potlood Set. Gerecycled Karton. 6 Potloden.

4.5 x 9 x 0.8 cm 500 / 25 Print Code: B(1)

Recycled Cardboard Black Line

New



Durcax 21089

Set. Recycled Cardboard. 7 Pieces.

Set. Recycling Pappe. 7 Stuk.

Set. Carton Recyclé. 7 Pièces.

Set. Gerecycled Karton. 7 Potloden.

Ø 2.7 x 10.6 cm 400 / 50 Print Code: B(1)



Recycled Cardboard



Aladín 8722

Set. Recycled Cardboard. 19 Pieces.
Set. Recycling Papper. 19 Stück.
Set. Carton Recyclé. 19 Pièces.
Set. Gerecycled Karton. 19 Stuks.

7.8 x 18.5 x 1.2 cm 200 / 25
 Print Code: B(4)



Pichi 8719

Crayon Set. Recycled Cardboard. 6 Crayons.
Wachsmalstifte Set. Recycling Papper. 6 Wachsmalstifte.
Boîte Crayons. Carton Recyclé. 6 Crayons.
Wasco Set. Gerecycled Karton. 6 Krijtjes.

5.3 x 9 x 0.9 cm 250 / 25 Print Code: B(4)

Pixi 3641

Set. Recycled Cardboard. 13 Pieces.
Set. Recycling Papper. 13 Stück.
Set. Carton Recyclé. 13 Pièces.
Set. Gerecycled Karton. 13 Stuks.

Ø 4.6 x 10 cm 200 / 10 Print Code: B(4), W



Remix 6083

Chalk Set. Recycled Cardboard. 4 Chalks.
Kreiden Set. Recycling Papper. 4 Kreiden.
Set Craies. Carton Recyclé. 4 Craies.
Krijtjes Set. Gerecycled Karton. 4 Krijtjes.

9.5 x 11 x 2.5 cm 100 / 50 Print Code: B(4)



04

03

19



SHARPENED

Gabon 5647

Set. Recycled Cardboard. 5 Pieces.
Set. Recycling Pappé. 5 Stück.
Set. Carton Recyclé. 5 Pièces.
Set. Gerecycled Karton. 5 Stuks.

4.5 x 17.7 x 1.5 cm 400 / 50
Print Code: B(4), W



05



Dony 3643

Set. Recycled Cardboard. 6 Pieces.
Set. Recycling Pappé. 6 Stück.
Set. Carton Recyclé. 6 Pièces.
Set. Gerecycled Karton. 6 Stuks.

4.5 x 17.7 x 1.3 cm 240 / 20
Print Code: B(4), W



Dragon 3386

Pencil Set. Wood. 6 Pencils.
Bleistiftbox. Holz. 6 Stifte.
Boîte Crayons. Bois. 6 Crayons.
Potlood Set. Hout. 6 Potloden.

20.5 x 2.5 x 3.5 cm 200 / 50
Print Code: D(2), L2



UNSHARPENED

Dernel 6607

Set. 5 Pieces.
Set. 5 Stück.
Set. 5 Pièces.
Set. 5 Stuks.

Ø 3.5 x 19 cm 200 / 50
Print Code: B(4), W

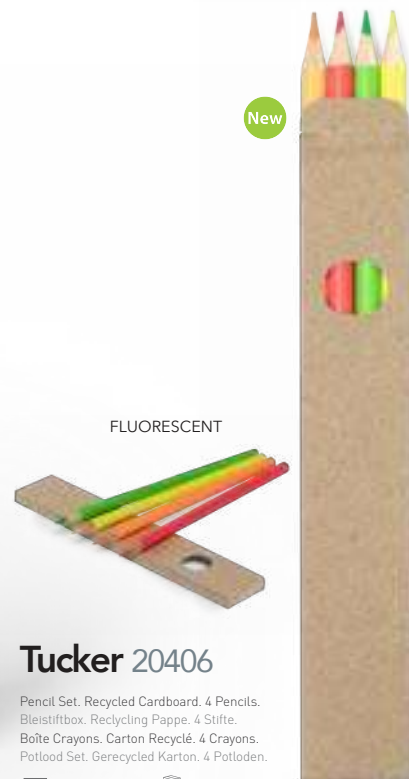

New

FLUORESCENT

Tucker 20406

Pencil Set. Recycled Cardboard. 4 Pencils.
Bleistiftbox. Recycling Pappé. 4 Stifte.
Boîte Crayons. Carton Recyclé. 4 Crayons.
Potlood Set. Gerecycled Karton. 4 Potloden.

3 x 18 x 0.9 cm 300 / 50
Print Code: B(4), W



Tune 9831

Crayon Set. Cardboard. 6 Crayons.
Wachsmalstifte Set. Pappe. 6 Wachsmalstifte.
Boîte Crayons. Carton. 6 Crayons.
Wasco Set. Karton. 6 Krijtjes.

5 x 8.3 x 0.8 cm 400 / 50 Print Code: B(4), W



19



Garten 9830

Pencil Set. Cardboard. 6 Pencils.
Bleistiftbox. Pappe. 6 Stifte.
Boîte Crayons. Carton. 6 Crayons.
Potlood Set. Karton. 6 Potloden.

5 x 9.3 x 0.8 cm 500 / 50 Print Code: B(4), W



05



Migal 5139

Pencil Case. Polyester 420D. 10 Pieces.
Federmappe. Polyester 420D. 10 Stück.
Trousse. Polyester 420D. 10 Pièces.
Etui. Polyester 420D. 10 Stuks.

4.5 x 10 x 4 cm 400 / 10 Print Code: F(1), N(8)



01 05 03 04



Boltex 5645

Mandala Set. Cardboard. 12 Pencils and 12 Sheets Included.
Mandala Set. Pappe. 12 Stifte und 12 Seiten Inklusiv.
Set Mandala. Carton. 12 Crayons et 12 Feuilles Incluses.
Mandala Set. Karton. 12 Potloden en 12 Blaadjes Inclusief.

9 x 9 x 1 cm 300 / 20 Print Code: B(4), W





Kinsky 6121

Pencil Case. 100% Cotton.
 Federmappe. 100% Baumwolle.
 Trousse. 100% Coton.
 Etui. 100% Katoen.

📏 7 x 22 cm 📦 500 / 50 🗑️ Print Code: F(1), N(8), O



13

Laybox 1668

Pencil Case. 100% Recycled Cotton.
 Federmappe. 100% Recycling Baumwolle.
 Trousse. 100% Coton Recyclé.
 Etui. 100% Gerecycled Katoen.

📏 22 x 11.5 cm 📦 300 / 50 🗑️ Print Code: F(1), N(8), O

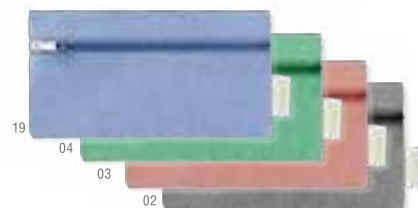

19

04

03

02



Sulpox 6166



Pencil Case. Jute/ Cotton. 5 Pieces.
 Federmappe. Jutestoff/ Baumwolle. 5 Stück.
 Trousse. Jute/ Coton. 5 Pièces.
 Etui. Jute/ Katoen. 5 Stuks.

📏 20 x 20 cm 📦 200 / 50 🗑️ Print Code: F(1), N(8)

Palermo 6942



Pencil Case. Wood. 5 Pieces.
 Federmappe. Holz. 5 Stück.
 Trousse. Bois. 5 Pièces.
 Etui. Hout. 5 Stuks.

📏 20 x 3.7 x 4.4 cm 📦 200 / 10 🗑️ Print Code: F(1), L1

Marfik 6167



Pencil Case. Jute/ Cotton. 5 Pieces.
 Federmappe. Jutestoff/ Baumwolle. 5 Stück.
 Trousse. Jute/ Coton. 5 Pièces.
 Etui. Jute/ Katoen. 5 Stuks.



📏 19 x 8.5 cm 📦 200 / 50 🗑️ Print Code: F(1), N(8)



Yeimy 6986

03

Pencil Case. Polyester 600D RPET.
 Federmappe. Polyester 600D RPET.
 Trousse. Polyester 600D RPET.
 Etui. Polyester 600D RPET.

 22 x 8 x 5 cm  300 / 50
 Print Code: F(1), N(8), O



19



02

04



Glaston 1481

Pencil Case. Felt RPET/ Bamboo.
 Federmappe. Filz RPET/ Bambus.
 Trousse. Feutrine RPET/ Bambou.
 Etui. Vilt RPET/ Bamboe.

 19.8 x 6.3 x 5.6 cm  50
 Print Code: F(1), L2

Bricex 1848

Multipurpose Bag. Felt RPET/ PU.
 Mehrzwecktasche. Filz RPET/ PU.
 Fourre-Tout. Feutrine RPET/ Similicuir.
 Multifunctioneel Tasje. Vilt RPET/ PU.

 21 x 12 x 4 cm  200 / 50
 Print Code: F(1), N(8)





Reiton 6943

Pencil Case. Cork/ Cotton.
 Federmappe. Kork/ Baumwolle.
 Trousse. Liège/ Coton.
 Etui. Kurk/ Katoen.

 20.5 x 6 x 6 cm  400 / 100  Print Code: F(1), N(8)

Bully 6039

Pencil Case. Cork.
 Federmappe. Kork.
 Trousse. Liège.
 Etui. Kurk.

 23 x 11 x 2 cm  200 / 50  Print Code: F(1), L1



03

Atecax 5514

Pencil Case. Polyester 600D.
 Federmappe. Polyester 600D.
 Trousse. Polyester 600D.
 Etui. Polyester 600D.

20 x 5 x 4.5 cm 500 / 10 Print Code: F(1), N(8), O, R



05



19



13



02



19

Celes 3987

Pencil Case. Polyester 600D.
 Federmappe. Polyester 600D.
 Trousse. Polyester 600D.
 Etui. Polyester 600D.

6.5 x 22.5 cm 250 / 10 Print Code: F(1), N(8), O



05



11



02



04



03



07

Pencil Case



05



03

Latber 4575

Pencil Case. PVC.
 Federmappe. PVC.
 Trousse. PVC.
 Etui. PVC.

24.5 x 11.5 cm 500 / 10 Print Code: F(1)



19



07

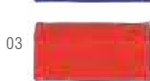

03



11



04



13



02



19



04



05

Tage 9976

Pencil Case. Polyester 600D.
 Federmappe. Polyester 600D.
 Trousse. Polyester 600D.
 Etui. Polyester 600D.

22 x 11.5 cm 500 / 10 Print Code: F(1), N(8), O

1 1 SPORT & FITNESS









Elisian 20432

Reflective Vest. Polyester. One Size. Adult. Homologated. Adjustable.
Warnweste. Polyester. Einheitsgröße. Erwachsene. Zugelassen. Verstellbar.
Gilet Réfléchissant. Polyester. Taille Unique. Adulte. Homologué. Ajustable.
Reflectorend Vest. Polyester. Eén Maat. Volwassen. Gehomologiseerd. Aanpasbaar.

 50 x 55 cm  100 / 50  Print Code: F(1)



05F



02



07F

Picton 6402

Reflective Armband. Polyester/ Elastane. Adjustable.
Reflektierend Armband. Polyester/ Elasthan. Verstellbar.
Bracelet Réfléchissant. Polyester/ Élasthanne. Ajustable.
Reflectorend Armband. Polyester/ Elastaan. Aanpasbaar.

 35 x 5 cm  500 / 50  Print Code: E(1), N(8)



03



19

02

01

04

Vilox 6246

Torch. 8 COB Lights. 3 Light Modes, Fixed and Flashing. 3 Batteries AAA Not Included.
Lampe. 8 COB Lichter. 3 Lichtpositionen, Festes und Blinkendes. 3 AAA Batterien Nicht im Lieferumfang.
Lampe. 8 Lumières COB. 3 Modes de Lumière, Fixe et Clignotante. 3 Piles AAA Non Incluses.
Zaklamp. 8 COB Lichter. 3 Licht Posities, Vast en Knipperend. 3 Batterijen AAA Niet Inclusief.

 6.1 x 4 x 1.7 cm  500 / 100  Print Code: E(1)





Wally 20179

Massager. 2 Modes. Battery 800 mAh. Polyester RPET Pouch.
 Massagegerät. 2 Positionen. Batterie 800 mAh. Polyester RPET Etui.
 Masseur. 2 Modes. Batterie 800 mAh. Étui Polyester RPET.
 Massage-Vorm. 2 Posities. Batterij 800 mAh. Polyester RPET Zakje.

11.3 x 10.2 x 5 cm 50 Print Code: E(1), F(1), N(8)



Owura 20452

Massager. 4 Accessories. 6 Modes. Battery 1200 mAh.
 Massagegerät. 4 Teile. 6 Positionen. Batterie 1200 mAh.
 Masseur. 4 Accessoires. 6 Modes. Batterie 1200 mAh.
 Massage-Vorm. 4 Accessoires. 6 Posities. Batterij 1200 mAh.

21 x 18.5 x 5.5 cm 10 Print Code: I(1)



Franium 20553

Hot-Cold Pack. Cold and Warm. Reusable.
 Wärme-Kälte Pflaster. Kalt und Warm. Wiederverwendbar.
 Patch Chaud-Froid. Chaud et Froid. Réutilisable.
 Thermisch Pakket. Koud en Warm. Herbruikbaar.

Ø 12.5 x 1.5 cm 100 / 50 Print Code: N(8)



Keinar 20552

Hot-Cold Pack. Cold and Warm. Reusable.
 Wärme-Kälte Pflaster. Kalt und Warm. Wiederverwendbar.
 Patch Chaud-Froid. Chaud et Froid. Réutilisable.
 Thermisch Pakket. Koud en Warm. Herbruikbaar.

20 x 12.5 x 1.5 cm 50 / 25 Print Code: N(8)



Nodal 6373

Mat. PVC.
Matte. PVC.
Natte. PVC.
Mat. PVC.

03

60 x 180 cm 20 Print Code: G(1)

02

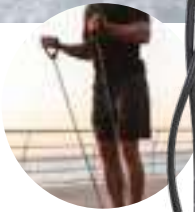

Rayden 6979

Exercise Band. TPE/ EVA. Resistance Medium. Polyester RPET Pouch.
Gummiband. TPE/ EVA. Widerstand Mittel. Polyester RPET Etui.
Bande de Résistance. TPE/ EVA. Résistance Moyenne. Étui Polyester RPET.
Fitness-Band. TPE/ EVA. Weerstand Gemiddeld. Polyester RPET Zakje.

25 x 49 x 6 cm 40 Print Code: G(1), N(8)



Turkol 1565

Exercise Ring. Fibreglass/ EVA/ ABS. Non-Woven RPET Pouch.
Übungsring. Fiberglass/ EVA/ ABS. Non-Woven RPET Etui.
Anneau d'Exercice. Fibre de Verre/ EVA/ ABS. Étui T.N.T. RPET.
Oefeningring. Glasvezel/ EVA/ ABS. Non-Woven Zakje RPET.

41 x 37 x 5.5 cm 15 Print Code: G(1)



Yum 1293

Glide Disk. ABS/ EVA. 2 Pieces. Polyester Pouch.
Gletscheiben. ABS/ EVA. 2 Stück. Polyester Etui.
Disques Derrapant. ABS/ EVA. 2 Pièces. Étui Polyester.
Glijdende Schijven. ABS/ EVA. 2 Stuks. Polyester Zakje.

Ø 17.5 x 0.8 cm 50 Print Code: F(1), G(1), N(8)



Resistance Band



Bork 6789

Exercise Bands Set. TPE. 3 Pieces. Resistance Light, Medium and Heavy. Polyester Pouch.
 Gummiband Set. TPE. 3 Stück. Widerstand Leicht, Mittel und Schwer. Polyester Etui.
 Set Bandes de Résistance. TPE. 3 Pièces. Résistance Faible, Moyenne et Élevée. Étui Polyester.
 Fitness-Band Set. TPE. 3 Stuks. Weerstand Licht, Gemiddeld en Zwaar. Polyester Zakje.

9 × 22 × 1 cm 200 / 100 Print Code: F(1), N(8)



Zhiax 6790

Fitness Set. TPE/ EVA. 2 Pieces. Band Resistance Medium. Polyester Pouch.
 Fitness Set. TPE/ EVA. 2 Stück. Gummiband Widerstand Mittel. Polyester Etui.
 Set Fitness. TPE/ EVA. 2 Pièces. Bande Résistance Moyenne. Étui Polyester.
 Fitness Set. TPE/ EVA. 2 Stuks. Band Weerstand Gemiddeld. Polyester Zakje.

11.5 × 22 × 6 cm 100 Print Code: F(1), N(8)



19

03

08

Vainen 1564

Exercise Band. Polyester/ Latex. Resistance Medium. Polyester Pouch.
 Gummiband. Polyester/ Latex. Widerstand Mittel. Polyester Etui.
 Bande de Résistance. Polyester/ Latex. Résistance Moyenne. Étui Polyester.
 Fitness-Band. Polyester/ Latex. Weerstand Gemiddeld. Polyester Zakje.

38 × 8 cm 100 / 50 Print Code: F(1), N(8)



100 x 50 cm

03

Gymnasio 4567

Absorbent Towel. Microfibre 185 g/ m2. Polyester Pouch.
 Saugfähiges Handtuch. Mikrofaser 185 g/ m2. Polyester Etui.
 Serviette Absorbante. Microfibre 185 g/ m2. Étui Polyester.
 Absorbierende Handdoek. Microfibre 185 g/ m2. Polyester Zakje.

📏 9 x 17 cm 📦 100 🖨️ Print Code: F(1), N(8), P, R



02



Kefan 5920

90 x 40 cm

Absorbent Towel. Microfibre 160 g/ m2.
 Saugfähiges Handtuch. Mikrofaser 160 g/ m2.
 Serviette Absorbante. Microfibre 160 g/ m2.
 Absorbierende Handdoek. Microfibre 160 g/ m2.

📏 90 x 40 cm 📦 100 🖨️ Print Code: F(1), N(8), P, R



03



SOFT-COOL EXTREME



New fabric SoftCool Extreme with UV protection. Quick and instant cooling at contact with moisture and movement.

HOW DOES IT WORK? DISCOVER MORE!!!



Rikat 5510

90 x 30 cm

Towel. 55% Nylon/ 45% Polyester 160 g/ m2. UV50 Protection.
 Handtuch. 55% Nylon/ 45% Polyester 160 g/ m2. UV50 Schutz.
 Serviette. 55% Nylon/ 45% Polyester 160 g/ m2. Protection UV50.
 Handdoek. 55% Nylon/ 45% Polyester 160 g/ m2. UV50 Bescherming.

📏 6.5 x 16.8 cm 📦 100 🖨️ Print Code: F(1), G(1), N(8)



Kotto 4554

45 x 30 cm

Absorbent Towel. Microfibre 345 g/ m2.
 Saugfähiges Handtuch. Mikrofaser 345 g/ m2.
 Serviette Absorbante. Microfibre 345 g/ m2.
 Absorbierende Handdoek. Microfibre 345 g/ m2.

📏 45 x 30 cm 📦 100 🖨️ Print Code: F(1), N(8), P, R





03





19

02

01

Slash 6980

Absorbent Towel. Polyester RPET 160 g/ m². Polyester RPET Pouch.
Saugfähiges Handtuch. Polyester RPET 160 g/ m². Polyester RPET Etui.
Serviette Absorbante. Polyester RPET 160 g/ m². Étui Polyester RPET.
Absorbierende Handdoek. Polyester RPET 160 g/ m². Polyester RPET Zakje.

 12 x 16 x 6 cm  100  Print Code: F(1), N(8), P, R



12 x 16 cm



New

03



19

08

07

04

Guds 20428

Absorbent Towel. Polyester RPET 160 g/ m². Polyester RPET Pouch.
Saugfähiges Handtuch. Polyester RPET 160 g/ m². Polyester RPET Etui.
Serviette Absorbante. Polyester RPET 160 g/ m². Étui Polyester RPET.
Absorbierende Handdoek. Polyester RPET 160 g/ m². Polyester RPET Zakje.

 12 x 16 x 6 cm  100/ 50  Print Code: F(1), N(8), P, R

100 x 50 cm



138 X 72 cm

19

Yarg 7065

Absorbent Towel. Microfibre 200 g/ m². Polyester Pouch.
Saugfähiges Handtuch. Mikrofaser 200 g/ m². Polyester Etui.
Serviette Absorbante. Microfibre 200 g/ m². Étui Polyester.
Absorbierende Handdoek. Microfibre 200 g/ m². Polyester Zakje.

 Ø9 x 17 cm  50  Print Code: F(1), N(8), P



11

04

03



800 ml

03

90 x 40 cm

Cloister 1410

Set. Bottle Aluminium 800 ml. Absorbent Towel Microfibre 160 g/ m².
Set. Trinkflasche Aluminium 800 ml. Saugfähiges Handtuch Mikrofaser 160 g/ m².
Set. Bidon Aluminium 800 ml. Serviette Absorbante Microfibre 160 g/ m².
Set. Fles Aluminium 800 ml. Absorbierende Handdoek Microfibre 160 g/ m².

 27.5 x 8.7 x 16 cm  20  Print Code: G(1), L2, L3, N(8), O, P, WR



01



19

06

SPORT
BOTTLE

01

Poel 20446

Foldable Bottle. TPU. 500 mL.
Faltbare Trinkflasche. TPU. 500 mL.
Bidon Pliable. TPU. 500 mL.
Opvouwbare Fles. TPU. 500 mL.

9.5 x 25 x 3.3 cm 250 / 50
Print Code: E(1)

500 ml

New



19



01

Sabik 20447

Foldable Cup. TPU. 230 mL.
Faltbarer Trinkbecher. TPU. 230 mL.
Verre Pliable. TPU. 230 mL.
Opvouwbare Beker. TPU. 230 mL.

Ø 7 x 11 cm 1000 / 50 Print Code: E(1)

230 ml

New



19

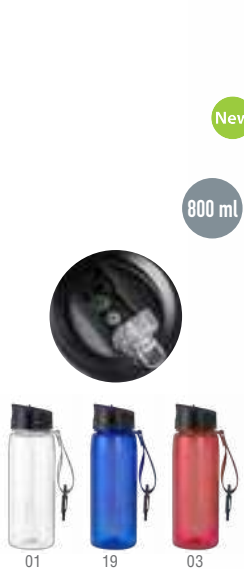

01

19

03

New

800 ml

Alborez 20448

Bottle. RPET. 800 mL.
Trinkflasche. RPET. 800 mL.
Bidon. RPET. 800 mL.
Fles. RPET. 800 mL.

Ø 7.5 x 23.5 cm 50 Print Code: F(1)

02



500 ml

03

02

05

19

07

11

01

Iskan 3837

Bottle. PE. 500 mL.
Trinkflasche. PE. 500 mL.
Bidon. PE. 500 mL.
Fles. PE. 500 mL.

Ø 6.5 x 19.5 cm 100 / 10 Print Code: F(1)

04



840 ml

03

02

05

04

07

11

01

Dumont 20449

Bottle. PE. 840 mL.
Trinkflasche. PE. 840 mL.
Bidon. PE. 840 mL.
Fles. PE. 840 mL.

Ø 7.5 x 25 cm 50 Print Code: F(1)

19



RECYCLED
aluminium



New

680 ml

Nolde 20722

Bottle. Recycled Aluminium. 680 ml.
Trinkflasche. Recycling Aluminium. 680 ml.
Bidon. Aluminium Recyclé. 680 ml.
Fles. Gerecycled Aluminium. 680 ml.

📏 Ø 7.3 x 22 cm 📦 50 🖨️ Print Code: F(1)



03

SPORT BOTTLE



02

New

1 L

Wanker 20720

Insulated Bottle. Stainless Steel. 1 L.
Wärme Flasche. Rostfreier Stahl. 1 L.
Bidon Thermique. Acier Inox. 1 L.
Thermoskan-Fles. Roestvrij Staal. 1 L.

📏 Ø 9 x 29.1 cm 📦 25 🖨️ Print Code: F(1)



01



03

02

New

600 ml

Fluxi 20736

Vaporizer Bottle. 600 ml.
Trinkflasche Zerstäuber. 600 ml.
Bidon Vaporisateur. 600 ml.
Fles Sproeier. 600 ml.

📏 Ø 8.2 x 25.2 cm 📦 30 🖨️ Print Code: F(1)



19



03

19

New

800 ml

Finterrix 21246

Bottle. PP. 800 ml.
Trinkflasche. PP. 800 ml.
Bidon. PP. 800 ml.
Fles. PP. 800 ml.

📏 Ø 9.4 x 22 cm 📦 50 🖨️ Print Code: E(1)



02



Kelan 5522

Armband. PU. Touch Screen. Reflective.
Armband. PU. Touch Screen. Reflektierend.
Bracelet. Similicuir. Écran Tactile. Réfléchissant.
Armband. PU. Touch Screen. Reflektierend.

11 x 17 cm 200 / 50 Print Code: F(1), N(8)

19



Wanel 5311

Waistbag. Lycra. Touch Screen. Reflective.
Gürteltasche. Lycra. Touch Screen. Reflektierend.
Banane. Lycra. Écran Tactile. Réfléchissant.
Heuptas. Lycra. Touch Screen. Reflektierend.

24 x 10.5 cm 100 / 50 Print Code: N(8)



03

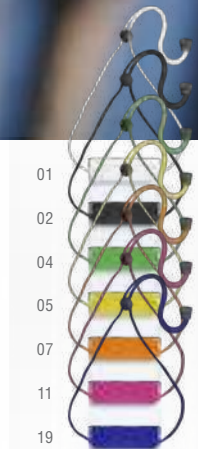

Rokdem 1610

Multipurpose Bag. PVC. Waterproof. Touch Screen.
Mehrzwecktasche. PVC. Wasserdicht. Touch Screen.
Fourre-Tout. PVC. Imperméable. Écran Tactile.
Multifunctioneel Tasje. PVC. Waterdicht. Touch Screen.

10 x 23.5 cm 500 / 50 Print Code: F(1)



03



Selasi 20903

Race Number Drawstring Bag. Polyester 210D.
 Startnummernrucksack. Polyester 210D.
 Sac à Dos avec Porte Numéro. Polyester 210D.
 Racenummerhouder Rugzak. Polyester 210D.

40 x 45 cm 200 / 50 Print Code: F(1), N(8), R



Basset 1620

Waistbag. Soft Shell. Reflective.
 Gürteltasche. Soft Shell. Reflektierender.
 Banane. Soft Shell. Réfléchissant.
 Heuptas. Soft Shell. Reflektierend.

38.5 x 9.5 cm 100 / 50 Print Code: N(8)

Rapik 4914

Race Number Holder Waistbag. Polyester/ Spandex.
 Startnummernträger. Polyester/ Spandex.
 Sac-Ceinture avec Porte Numéro. Polyester/ Spandex.
 Racenummerhouder Heuptas. Polyester/ Spandex.

22 x 3.5 cm 200 / 10 Print Code: N(8)



YOGA

Accessories



Natara 1075

Yoga Block. Cork.
Yoga-Block. Kork.
Bloc de Yoga. Liège.
Yoga Blok. Kurk.

22.5 x 7.5 x 15 cm 15 Print Code: F(1), G(1), L2



Padma 1077

Mat. Cork/ TPE.
Matte. Kork/ TPE.
Natte. Liège/ TPE.
Mat. Kurk/ TPE.

60 x 180 cm 10 Print Code: F(1), G(1), L2, N(8)



Wendy 1650

Massager. Bamboo.
Massagegerät. Bambus.
Masseur. Bambou.
Massage-Vorm. Bamboe.

11.3 x 8.6 x 1.4 cm 150 / 50 Print Code: C(4), L1

Tuduk 1251

Balls Set. Cork. 2 Pieces. Cotton Pouch.
Kugeln Set. Kork. 2 Stück. Baumwolle Etui.
Set Balles. Liège. 2 Pièces. Étui Coton.
Ballen Set. Kurk. 2 Stuks. Katoen Zakje.

Ø 6 cm 100 / 50 Print Code: G(1), L1, N(8)



Uttana 1076

Muscle Roller. Cork.
Muskelroller. Kork.
Rouleau Musculaire. Liège.
Spier Roller. Kurk.

Ø 9.5 x 30 cm 15 Print Code: F(1), G(1), L2



Lakex 1156

Skipping Rope. Adjustable. Polyester RPET Pouch.
Sprungseil. Einstellbar. Polyester RPET Etui.
Corde à Sauter. Réglable. Étui Polyester RPET.
Springtouw. Verstelbaar. Polyester RPET Zakje.

📏 Ø 0.3 x 300 cm 📦 100 🔄 Print Code: G(1), N(8)



Grimluck 1441



Digital Skipping Rope. Polyester RPET Pouch. Button Battery Included.
Digital Sprungseil. Polyester RPET Etui. Knopfzelle Inklusive.
Corde à Sauter Digitale. Étui Polyester RPET. Pile Bouton Inclusive.
Digitaal Springtouw. Polyester RPET Zakje. Knopcel Batterij Inclusief.

📏 17 x 21 x 3.5 cm 📦 100 / 50 🔄 Print Code: G(1), N(8)



Derix 4639

Skipping Rope.
Sprungseil.
Corde à Sauter.
Springtouw.

📏 Ø 0.7 x 257 cm 📦 200 / 50 🔄 Print Code: D(1)



Galtax 5904

Skipping Rope. Wood.
Sprungseil. Holz.
Corde à Sauter. Bois.
Springtouw. Hout.

📏 Ø 0.7 x 260 cm 📦 200 / 50 🔄 Print Code: D(1), L1



Panky 6978

Skipping Rope. Wood/ Cotton. Cotton Pouch.
Sprungseil. Holz/ Baumwolle. Baumwolle Etui.
Corde à Sauter. Bois/ Coton. Étui Coton.
Springtouw. Hout/ Katoen. Katoen Zakje.

📏 Ø 0.8 x 310 cm 📦 50 🔄 Print Code: G(1), D(1), L1, N(8)

RPET ♻️



03



Arilyn 20505

Headband. Polyester.
Stirnband. Polyester.
Bandeau Tête. Polyester.
Hoofdband. Polyester.



19

02

01

04

22.5 x 8 cm

300 / 10

Print Code: E(1), N(8), R



19



02

03

01

Micra 3572

Swim Hat. Polyester/ Spandex.
Badekappe. Polyester/ Spandex.
Bonnet de Piscine. Polyester/ Spandex.
Zwemmuts. Polyester/ Spandex.



Consult.

400 / 50

Print Code: E(1), N(8), R



New

Vitonok 20566

Set. PP. Ear Plugs and 5 Adhesive Nasal Strips.
Set. PP. Ohrstöpsel und 5 Nasenpflaster.
Set. PP. Bouchons d'oreilles et 5 Bandes Nasales Adhésives.
Set. PP. Oordopjes en 5 Plakneusstrips.

10.5 x 2.5 x 4.5 cm

200 / 50

Print Code: C(1), V



02



01



03



19

Tecnico Gerox 4472

Shorts. 100% Polyester 145 g/ m2. Breathable.
Shorts. 100% Polyester 145 g/ m2. Atmungsaktiv.
Shorts. 100% Polyester 145 g/ m2. Respirant.
Shorts. 100% Polyester 145 g/ m2. Ademend.

8-10, 12-14, S, M, L, XL

100 / 10

Print Code: F(6), N(8), O, P, R



TECHNICAL FABRIC



BREATHABLE



ACTION DRY



CREASE FREE



TECHNICAL FABRIC



BREATHABLE



ACTION DRY



WHITE COLOUR SUITABLE FOR SUBLIMATION



UNISEX

Duttier 5125

Arm Sleeves. Polyester/ Elastane.
Ärmelschoner. Polyester/ Elastan.
Manchon Bras. Polyester/ Élasthanne.
Arm Warmer. Polyester/ Elastaan.

43 cm

200 / 100

Print Code: F(1), N(8), R



01



05



02



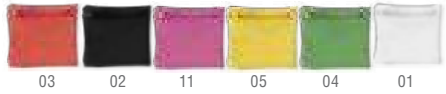

19



Oakley 3618

Wristband. Microfibre.
Armbandtasche. Mikrofaser.
Tour de Poignet. Microfibre.
Armband. Microfibre.

 10 x 9 cm  1000 / 100  Print Code: E(1), N(8), R



New

03



Kelsey 20445

Wristband. 80% Cotton/ 20% Elastane.
Armbandtasche. 80% Baumwolle/ 20% Elastan.
Tour de Poignet. 80% Coton/ 20% Élasthanne.
Armband. 80% Katoen/ 20% Elastaan.

 8 x 12 cm  500 / 10  Print Code: N(8)



New

03

Rolins 20430

Wristband. Polyester RPET.
Armbandtasche. Polyester RPET.
Tour de Poignet. Polyester RPET.
Armband. Polyester RPET.

 10.5 x 9.5 cm  500 / 100  Print Code: E(1), N(8)



08

19

Vanzox 5917

Touchscreen Sport Gloves. Polyester/ Lycra. One Size. Adult.
Touchpad Sport Handschuhe. Polyester/ Lycra. Einheitsgröße. Erwachsene.
Gant Sportif Tactile. Polyester/ Lycra. Taille Unique. Adulte.
Touchscreen Sport Handschoenen. Polyester/ Lycra. Eén Maat. Volwassen.

 Consult.  200 / 10  Print Code: E(1), N(8)



03

TWO TOUCH
SCREEN
FINGERTIPS

Scot 20450

Sport Gloves. Soft Shell.
Sport Handschuhe. Soft Shell.
Gant Sportif. Soft Shell.
Sport Handschoenen. Soft Shell.

 S-M, L- XL  50  Print Code: F(1), N(8)



New





03



Sporter 3316

Vest. Polyester 190T. One Size. Adult.
 Weste. Polyester 190T. Einheitsgröße. Erwachsene.
 Chasuble. Polyester 190T. Taille Unique. Adulte.
 Vest. Polyester 190T. Eén Maat. Volwassen.

52 x 63 cm 300 / 25 Print Code: F(1)



19



Cambex 4531

Vest. Non-Woven. One Size. Adult.
 Weste. Non-Woven. Einheitsgröße. Erwachsene.
 Chasuble. T.N.T. Taille Unique. Adulte.
 Vest. Non-Woven. Eén Maat. Volwassen.

53 x 66 cm 200 / 25 Print Code: F(1)



19



Wiki 3317

Vest. Polyester 190T. One Size. Kids.
 Weste. Polyester 190T. Einheitsgröße. Kinder.
 Chasuble. Polyester 190T. Taille Unique. Enfant.
 Vest. Polyester 190T. Eén Maat. Kind.

38 x 45 cm 600 / 50 Print Code: F(1)



07



Yopet 4649

Whistle.
 Pfeife.
 Sifflet.
 Fluitje.

1.9 x 5 x 2.4 cm 1000 / 250
 Print Code: C(1)



02

Zubigol 3115

Goal Post. Nylon. Foldable. Polyester Pouch.
 Strandfussballtor. Nylon. Faltbar. Polyester Etui.
 Cage de Buts. Nylon. Pliable. Étui Polyester.
 Doel. Nylon. Opvouwbaar. Polyester Zakje.

141 x 80 x 80 cm 20
 Print Code: I(6)



01

03

19





Horisun 20451

Ball. PU/ PVC. Size: 5.
Ball. PU/ PVC. Größe: 5.
Ballon. Similicuir/ PVC. Taille: 5.
Voetbal. PU/ PVC. Maat: 5.

Consult. 40 Print Code: G(1)



Dulsek 6967

Ball. PU/ PVC. Size: 5.
Ball. PU/ PVC. Größe: 5.
Ballon. Similicuir/ PVC. Taille: 5.
Voetbal. PU/ PVC. Maat: 5.

Consult. 40 Print Code: G(1)



Delko 4086

Ball. PU/ PVC. Size: 5.
Ball. PU/ PVC. Größe: 5.
Ballon. Similicuir/ PVC. Taille: 5.
Voetbal. PU/ PVC. Maat: 5.

Consult. 40 Print Code: G(1)



Lidok 6968

Ball. PU/ PVC. Size: 5.
Ball. PU/ PVC. Größe: 5.
Ballon. Similicuir/ PVC. Taille: 5.
Voetbal. PU/ PVC. Maat: 5.

Consult. 40 Print Code: G(1)



Lafin 20429

Ball Bag. Polyester 600D RPET.
Balltasche. Polyester 600D RPET.
Sac de Ballon. Polyester 600D RPET.
Balzak. Polyester 600D RPET.

25 x 24 x 30 cm 50 Print Code: G(1), N(B)



Shoe BAGS



02

06

Helanor 1563

Shoe Bag. Polyester 600D RPET.
Schuhtasche. Polyester 600D RPET.
Sac Chaussures. Polyester 600D RPET.
Schoenenentas. Polyester 600D RPET.

 18,5 x 37 x 12,5 cm  100 / 25
 Print Code: F(1), N(8), O



08



07

03

19

Pirlo 3250

Shoe Bag. Polyester 600D.
Schuhtasche. Polyester 600D.
Sac Chaussures. Polyester 600D.
Schoenenentas. Polyester 600D.

 35 x 16 x 15 cm  100 / 25
 Print Code: F(1), N(8), O





02



19

Paxer 6632

Drawstring Bag. Polyester 210D.
Rucksack. Polyester 210D.
Sac à Dos. Polyester 210D.
Rugzak. Polyester 210D.

 56 x 42 cm  300 / 10
 Print Code: F(1), N(8), R



04

03

01

07

02

05



SUBLIMATION



G

Naiper 5889

Drawstring Bag. Polyester 210D.
Rucksack. Polyester 210D.
Sac à Dos. Polyester 210D.
Rugzak. Polyester 210D.

 42 x 43 cm  300 / 20
 Print Code: F(1), N(8)



D

C



03



02



06

Dorian 4466

Backpack. Polyester 600D. Padded Back and Shoulder Straps. Shoe Compartment.

Rucksack. Polyester 600D. Gepolsterter Rücken und Schultergurte. Schuh Staufach.

Sac à Dos. Polyester 600D. Dos et Bretelles Rembourrées. Compartiment Porte-Chaussures.

Rugzak. Polyester 600D. Gewatteerde Achterzijde en Schouderbanden. Schoen Compartment.

📏 30 x 46 x 15 cm 📦 40 🖨️ Print Code: G(1), N(8)



19

04

05



03

New



Storil 20453

Backpack. Polyester 600D RPET. Padded Back and Shoulder Straps. Shoe Compartment.

Rucksack. Polyester 600D RPET. Gepolsterter Rücken und Schultergurte. Schuh Staufach.

Sac à Dos. Polyester 600D RPET. Dos et Bretelles Rembourrées. Compartiment Porte-Chaussures.

Rugzak. Polyester 600D RPET. Gewatteerde Achterzijde en Schouderbanden. Schoen Compartment.

📏 28 x 42 x 32 cm 📦 15

🖨️ Print Code: G(1), N(8)



19

02

04

RPET



06

Charmix 1042

Bag. Polyester 290T RPET.

Tasche. Polyester 290T RPET.

Sac. Polyester 290T RPET.

Tas. Polyester 290T RPET.

📏 Ø 23 x 48 cm 📦 100 / 25

🖨️ Print Code: G(1)



02



08



04



19



04



02

Wistol 20454

Bag. Polyester 600D RPET. Shoe Compartment.

Tasche. Polyester 600D RPET. Schuh Staufach.

Sac. Polyester 600D RPET. Compartiment Porte-Chaussures.

Tas. Polyester 600D RPET. Schoen Compartment.

📏 48 x 46 x 25 cm 📦 10

🖨️ Print Code: G(1), N(8)



03

New

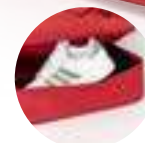



Helton 1960



Headphones. Bluetooth Connection. Battery 250 mAh.
Kopfhörer. Bluetooth Anschluss. Batterie 250 mAh.
Écouteurs. Connexion Bluetooth. Batterie 250 mAh.
Oordopjes. Bluetooth Verbinding. Batterij 250 mAh.

13 x 4.3 x 10.2 cm

50

Print Code: F(1)



04

19

Dragon 5313

Watch. Silicone Strap. Button Battery Included.
Uhr. Silikonarmband. Knopfzelle Inklusiv.
Montre. Bracelet Silicone. Pile Bouton Inclusive.
Horloge. Siliconen Band. Knoopcel Batterij Inclusief.

25 x 2.8 x 1.5 cm

100 / 50

Print Code: F(1)



02

01

05

03



05



03

Perch 4992



Holder. Adjustable.
Halter. Verstellbar.
Support. Adjustable.
Houder. Aanpasbaar.

7 x 2.7 x 4.8 cm

500 / 25

Print Code: D(1)



11

02



19

01



07

04



Fewil 1575

Scooter Bag. Polyester 600D RPET.
 Scootertasche. Polyester 600D RPET.
 Sac à Scooter. Polyester 600D RPET.
 Scootertas. Polyester 600D RPET.

 11 x 19.5 x 8.3 cm  100 / 20
 Print Code: G(1)



Nurbur 20439

Pouch. PVC. Touch Screen.
 Hülle. PVC. Touch Screen.
 Étui. PVC. Écran Tactile.
 Hoes. PVC. Touch Screen.

 10.5 x 21 cm  100 / 50  Print Code: F(1)



ADJUSTABLE



Lonter 5883

Holder. Adjustable.
 Halter. Verstellbar.
 Support. Ajustable.
 Houder. Aanpasbaar.

 10.8 x 9.9 x 12 cm  100 / 50  Print Code: E(1)



Rigon 5523

Bike Bag. Polyester 600D. Touch Screen. Reflective. Padded.
 Fahrradtasche. Polyester 600D. Touch Screen. Reflektierend. Gepolstert.
 Sac à Vélo. Polyester 600D. Écran Tactile. Réfléchissant. Rembourrée.
 Fietstas. Polyester 600D. Touch Screen. Reflecterend. Gewatteerd.

 19 x 10.5 x 9 cm  50 / 10  Print Code: N(8)



RPET 

Ritok 1576

Bike Bag. Polyester 600D RPET. Padded.
 Fahrradtasche. Polyester 600D RPET. Gepolstert.
 Sac à Vélo. Polyester 600D RPET. Rembourrée.
 Fietstas. Polyester 600D RPET. Gewatteerd.

 17 x 9.5 x 8 cm  100 / 20  Print Code: G(1), N(8)



Hydoria 20444

Bike Bag. PVC. Waterproof.
 Fahrrad Tasche. PVC. Wasserabweisende.
 Sac de Vélo. PVC. Imperméable.
 Fiets Tas. PVC. Waterdicht.

 18 x 24 x 6.5 cm  50 / 25  Print Code: G(1), N(8)

New



Leven 6725



Bike Bag. Polyester 600D.
 Fahrradtasche. Polyester 600D.
 Sac à Vélo. Polyester 600D.
 Fietstas. Polyester 600D.

 20 x 18 x 7.5 cm  100 / 10  Print Code: G(1), N(8)



Gerald 1218



Bike Repair Kit. Polyester 600D. 15 Accessories.
 Fahrrad-Reparaturset. Polyester 600D. 15 Teile.
 Kit de Réparation de Vélo. Polyester 600D. 15 Accessoires.
 Fiets Reparatie Set. Polyester 600D. 15 Accessoires.

 9.5 x 12 x 4 cm  40 / 20  Print Code: F(1), N(8)



Premoz 20431



Bike Repair Kit. PP. 15 Accessories.
 Fahrrad-Reparaturset. PP. 15 Teile.
 Kit de Réparation de Vélo. PP. 15 Accessoires.
 Fiets Reparatie Set. PP. 15 Accessoires.

 12 x 2.5 x 7.5 cm  50 / 25  Print Code: D(1)



Diede 20435

Mini Inflation Pump. 3 Accessories.
 Mini Luftpumpe. 3 Teile.
 Mini Pompe à Gonflage. 3 Accessoires.
 Mini Luchtpomp. 3 Accessoires.

 2.5 x 21 x 3.5 cm  100 / 50  Print Code: E(1)

New





New



Hoblak 20443

Bike Backpack. Polyester 600D RPET.
Padded Shoulder Straps.
Fahrrad Rucksack. Polyester 600D RPET.
Gepolsterte Schultergurte.
Sac à Dos de Vélo. Polyester 600D RPET.
Bretelles Rembourrées.
Fiets Rugzak. Polyester 600D RPET.
Gewatteerde Schouderbanden.

32 x 39 x 12 cm 20 Print Code: G(1), N(8)



New



Hulken 20442

Bike Bag. Polyester 600D RPET.
Fahrrad Tasche. Polyester 600D RPET.
Sac de Vélo. Polyester 600D RPET.
Fiets Tas. Polyester 600D RPET.

34 x 38 x 14 cm 20 Print Code: G(1), N(8)



15"
LAPTOP
COMPARTMENT

Halton 5972

Indicator Backpack. Polyester 600D. Flashing Led Lights. Padded Laptop Compartment. Padded Back and Shoulder Straps. USB Connection.
Rucksack-Anzeiger. Polyester 600D. Blinkendes Led Lichter. Gepolsterte Laptoflasche. Gepolsterter Rücken und Schultergurte. Anschluss USB.
Sac à Dos Indicateur. Polyester 600D. Lumières Led Clignotantes. Pochette Rembourrée pour Portable. Dos et Bretelles Rembourrées. Connexion USB.
Rugzak Richtingaangever. Polyester 600D. Knipperend Led Lichten. Gewatteerd Laptop Compartment. Gewatteerde Achterzijde en Schouderbanden. USB Connectie.

28 x 44 x 14 cm 15 Print Code: N(8)



Bike ACCESSORIES



Tolfen 1574

Bike Bell, Aluminium.
Fahrradklingel, Aluminium.
Sonnette Vélo, Aluminium.
Fietsbel, Aluminium.

7 x 5,4 x 5,3 cm 200 / 100
 Print Code: E(1), L1, V



Lespley 6172



Saddle Cover, Polyester 190T, Adjustable.
Fahrradsattel Hülle, Polyester 190T, Verstellbar.
Étui Selle, Polyester 190T, Ajustable.
Zadelt Hoes, Polyester 190T, Aanpasbaar.

Consult. 1000 / 500 Print Code: E(1), R

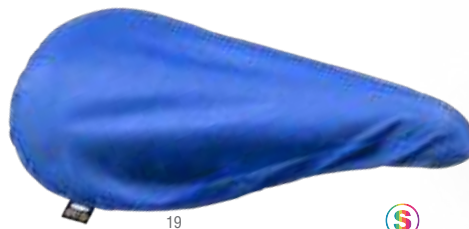

Mapol 6853



Saddle Cover, Polyester 190T RPET, Adjustable.
Fahrradsattel Hülle, Polyester 190T RPET, Verstellbar.
Étui Selle, Polyester 190T RPET, Ajustable.
Zadelt Hoes, Polyester 190T RPET, Aanpasbaar.

Consult. 1000 / 500
 Print Code: E(1), R



Triyo 6491

Padlock, PVC/ Metal.
Kofferschloss, PVC/ Metaal.
Antivol a Velo, PVC/ Métal.
Hangslot, PVC/ Metaal.

Ø 1.2 x 69 cm 100 / 50 Print Code: E(1)



RPET



Bike

Torch & Safety Light



Kups 20437

Bike Safety Light. 1 Led. Solar Charging. 3 Light Modes, Fixed and Flashing. Battery 1200 mAh.
 Sicherheitslicht. 1 Led. Solarladung. 3 Lichtpositionen, Festes und Blinkendes. Batterie 1200 mAh.
 Lumière de Sécurité. 1 Led. Charge Solaire. 3 Modes de Lumière, Fixe et Clignotante. Batterie 1200 mAh.
 Veiligheidslicht. 1 Led. Zonnelading. 3 Licht Posities, Vast en Knipperend. Batterij 1200 mAh.

13 x 9 x 5.5 cm 50 Print Code: E(t)



Remko 20438

Bike Safety Light Set. 2 Pieces. 3 Leds. 4 Light Modes, Fixed and Flashing. Battery 650 mAh.
 Sicherheitslicht Set. 2 Stück. 3 Leds. 4 Lichtpositionen, Festes und Blinkendes. Batterie 650 mAh.
 Set Lumière de Sécurité. 2 Pièces. 3 Leds. 4 Modes de Lumière, Fixe et Clignotante. Batterie 650 mAh.
 Veiligheidslicht Set. 2 Stuks. 3 Leds. 4 Licht Posities, Vast en Knipperend. Batterij 650 mAh.

10.7 x 3.5 x 4.7 cm 100 / 50 Print Code: E(t)



Myrto 3685

Torch. 2 Leds. 3 Light Modes, Fixed and Flashing. Button Batteries Included.
 Lampe. 2 Leds. 3 Lichtpositionen, Festes und Blinkendes. Knopfzellen Inklusiv.
 Lampe. 2 Leds. 3 Modes de Lumière, Fixe et Clignotante. Piles Bouton Incluses.
 Zaklamp. 2 Leds. 3 Licht Posities, Vast en Knipperend. Knopcel Batterijen Inclusief.

3.1 x 3.1 x 4.3 cm 500 / 50 Print Code: L1



Havu 20436

Bike Safety Light. 10 COB Lights. 5 Light Modes, Fixed and Flashing. Battery 500 mAh.
 Sicherheitslicht. 10 COB Lichten. 5 Lichtpositionen, Festes und Blinkendes. Batterie 500 mAh.
 Lumière de Sécurité. 10 Lumières COB. 5 Modes de Lumière, Fixe et Clignotante. Batterie 500 mAh.
 Veiligheidslicht. 10 COB Lichten. 5 Licht Posities, Vast en Knipperend. Batterij 500 mAh.

8.3 x 1.2 x 2.3 cm 200 / 100 Print Code: D(1)



Bowel 1217

Bike Safety Light Set. 2 Pieces. 1 Led. 2 Light Modes, Fixed and Flashing. Button Batteries Included.
 Sicherheitslicht. 2 Stück. 1 Led. 2 Lichtpositionen, Festes und Blinkendes. Knopfzellen Inklusiv.
 Lumière de Sécurité. 2 Pièces. 1 Led. 2 Modes de Lumière, Fixe et Clignotante. Piles Bouton Incluses.
 Veiligheidslicht. 2 Stuks. 1 Led. 2 Licht Posities, Vast en Knipperend. Knopcel Batterijen Inclusief.

9.5 x 2.1 x 4.2 cm 250 / 25 Print Code: D(4), C(1)



Hese 20426

Golf Ball Cleaning Pouch. Soft Shell.
Golfball Reinigungshülle. Soft Shell.
Étui Nettoyant Balle Golf. Soft Shell.
Golfbal Reinigingshoes. Soft Shell.

10 × 10 cm 500 / 100 Print Code: D(1), N(8)



01



03



05

Nessa 4410

Golf Ball.
Golfball.
Balle Golf.
Golfbal.

Ø 4.2 cm 300 / 10 Print Code: D(4)



Caddie 1566

Golf Set. 6 Accessoires.
Golf Set. 6 Teile.
Set Golf. 6 Accessoires.
Golf Set. 6 Accessoires.

Ø 4.6 × 14.8 cm 100 / 50
Print Code: E(1)



19 05 03 01

04

Ramsy 5440



Pencil. Wood.
Bleistift. Holz.
Crayon. Bois.
Potlood. Hout.

Ø 0.7 × 8.7 cm 3000 / 100 Print Code: A(4), L1



05 03 19

Hydor 4411

Golf Tee. Wood.
Golf Tee. Holz.
Tee Golf. Bois.
Golf Tee. Hout.

Ø 1.1 × 7 cm 10000 / 100 Print Code: A(4)



01



Tunker 5441

Golf Tee Card. 2 Pieces.
Golf Tee Karten. 2 Stück.
Carte Tee Golf. 2 Pièces.
Golf Tee Kaart. 2 Stuks.

5 × 9.5 × 0.2 cm 1000 / 100 Print Code: B(4), W



02 06

50 x 40 cm

Tarkyl 4403

Golf Towel. 100% Cotton 650 g/ m2.
 Golf Handtuch. 100% Baumwolle 650 g/ m2.
 Serviette Golf. 100% Coton 650 g/ m2.
 Golf Handdoek. 100% Katoen 650 g/ m2.

20 x 40 cm 100
 Print Code: F(1), N(8), P



04 06

60 x 40 cm

Brylix 20427

Golf Towel. Polyester RPET 200 g/ m2.
 Golf Handtuch. Polyester RPET 200 g/ m2.
 Serviette Golf. Polyester RPET 200 g/ m2.
 Golf Handdoek. Polyester RPET 200 g/ m2.

20 x 40 cm 200 / 50
 Print Code: F(1), N(8), P

New



02



Ø 135 cm

Budyx 4393

Golf Umbrella. Pongee 190T. Fiberglass Ribs. 31". Windproof.
 Golf Regenschirm. Pongee 190T. Fiberglass Rippen. 31".
 Antiwindsystem.
 Parapluie Golf. Pongée 190T. Tiges Fibre de Verre. 31".
 Système Anti-Vent.
 Golf Paraplu. Pongee 190T. Glasvezel Ribben. 31".
 Windbestendig.

Ø 135 cm 20 / 10 Print Code: H(1), N(8), R



Zebber 5442

Divot.
 Divot.
 Divot.
 Divot.

2,6 x 7 x 0,5 cm 2000 / 100 Print Code: C(4), W

Grent 5444

Golf Set. 4 Accessories.
 Golf Set. 4 Tette.
 Set Golf. 4 Accessoires.
 Golf Set. 4 Accessoires.

11,6 x 3 x 9,5 cm 50
 Print Code: B(4), D(4), L1

1 2 OUTDOOR & PICNIC





New



New



New

Demuth 20892

Waistbag. Polyester 800D.
Gürteltasche. Polyester 800D.
Banane. Polyester 800D.
Heuptas. Polyester 800D.

39 x 15 x 9.5 cm 30 Print Code: F(1), N(8)

Gertler 20893

Shoulder Bag. Polyester 800D.
Umhängetasche. Polyester 800D.
Bandoulière. Polyester 800D.
Schoudertas. Polyester 800D.

11 x 16 x 6.5 cm 50 Print Code: F(1), N(8)

Salced 20894

Backpack. Polyester 800D. Padded Back and Shoulder Straps.
Rucksack. Polyester 800D. Gepolsterter Rücken und Schultergurte.
Sac à Dos. Polyester 800D. Dos et Bretelles Rembourrées.
Rugzak. Polyester 800D. Gewatteerde Achterzijde en Schouderbanden.

31 x 44 x 20 cm 10 Print Code: G(1), N(8)

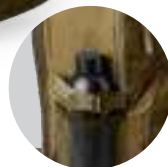



Kampasi 20455

Compass.
Kompass.
Boussole.
Kompas.

4,6 x 5,9 x 1,6 cm 500 / 50 Print Code: D(1), V



Clark 4439

Compass.
Kompass.
Boussole.
Kompas.

3 x 6,9 x 1,1 cm 1000 / 50 Print Code: C(1)



Kupra 6374

5in1
MULTI-FUNCTION

Multifunction Arm Strap. Nylon. 5 Functions.
Multifunktion Armband. Nylon. 5 Funktionen.
Bracelet Multifonction. Nylon. 5 Fonctions.
Multifunctioneel Armband. Nylon. 5 Functies.

25,5 x 3,4 x 1,1 cm 300 / 50 Print Code: L1



Saida 7286

Compass. Aluminium.
Kompass. Aluminium.
Boussole. Aluminium.
Kompas. Aluminium.

5,7 x 16 x 3 cm 100 / 10 Print Code: E(1), L1

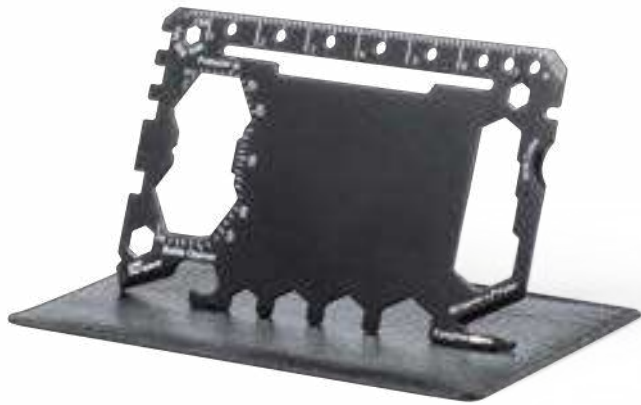

Frest 1592

Multitool. Stainless Steel. 17 Functions. PU Pouch.
 Multiwerkzeug. Rostfreier Stahl. 17 Funktionen. PU Etui.
 Multi Outils. Acier Inox. 17 Fonctions. Étui Similicuir.
 Multitool. Roestvrij Staal. 17 Functies. PU Zakje.

9.4 × 6.4 × 0.2 cm 400 / 100 Print Code: D(1), L1



Olexa 20458

Multitool. Stainless Steel. 16 Functions.
 Multiwerkzeug. Rostfreier Stahl. 16 Funktionen.
 Multi Outils. Acier Inox. 16 Fonctions.
 Multitool. Roestvrij Staal. 16 Functies.

4.2 × 12.7 × 0.9 cm 200 / 50 Print Code: D(1), L1



Argix 20486

Multitool. Aluminium. 20 COB Lights. 10 Functions.
 Magnetic. Battery 500 mAh.
 Multiwerkzeug. Aluminium. 20 COB Lichter. 10
 Funktionen. Magnetisch. Batterie 500 mAh.
 Multi Outils. Aluminium. 20 Lumières COB. 10
 Fonctions. Magnétique. Batterie 500 mAh.
 Multitool. Aluminium. 20 COB Lichten. 10 Functies.
 Magnetisch. Batterij 500 mAh.

5 × 9.5 × 3 cm 50 Print Code: E(1)



Skabix 6041

Snow Shovel. Carbon Steel. Foldable. Polyester Pouch.
 Schneeschaukel. Kohlenstoff Stahl. Faltbar. Polyester Etui.
 Pelle à Neige. Acier Carbone. Pliable. Étui Polyester.
 Sneeuwschep. Carbon-Staal. Opvouwbaar. Polyester Zakje.

11.5 × 46.5 × 5 cm 20 Print Code: I(8), L2



Demil 6250

Lamp. 30 COB Lights. 3 Batteries AAA Not Included.
Lampe. 30 COB Lichter. 3 AAA Batterien Nicht im Lieferumfang.
Lampe. 30 Lumières COB. 3 Piles AAA Non Incluses.
Lamp. 30 COB Lichten. 3 Batterijen AAA Niet Inclusief.

▮ 6.9 x 13.9 cm 📖 100 / 50 🗑️ Print Code: F(1)

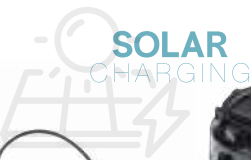

1200
mAh

Mufar 1573

Power Bank Lamp. 7 Leds. 1200 mAh. Solar Charging. USB Output. Micro USB Input.

Power Bank Lampe. 7 Leds. 1200 mAh. Solarladung. USB Ausgang. Micro USB Eingang.

Lampe Power Bank. 7 Leds. 1200 mAh. Charge Solaire. Sortie USB. Entrée Micro USB.

Power Bank Lamp. 7 Leds. 1200 mAh. Zonnelading. USB Output. Micro USB Input.

▮ 9.4 x 19.8 cm 📖 30 🗑️ Print Code: F(1)



Runix 1222

Table. Polyester 600D/ Metal. Foldable. Polyester Pouch.
Tisch. Polyester 600D/ Metall. Faltbar. Polyester Etui.
Table. Polyester 600D/ Métal. Pliable. Étui Polyester.
Tafel. Polyester 600D/ Metaal. Opvouwbaar. Polyester Zakje.

▮ 40 x 60 x 39 cm 📖 12 🗑️ Print Code: H(8)



02

Calix 4541

Sleeping Bag. Polyester. Polyester Pouch.
Schlafsack. Polyester. Polyester Etui.
Sac couchage. Polyester. Étui Polyester.
Slaapzak. Polyester. Polyester Zakje.

▮ 75 x 185 cm 📖 10 🗑️ Print Code: H(1), N(8)



04

19

03

RNYLON



Camping 1121

Hammock. Nylon Recycled. Nylon Recycled Pouch.
Hängematte. Recycling Nylon. Recycling Nylon Etui.
Hamac. Nylon Recyclé. Étui Nylon Recyclé.
Hangmat. Gerecycled Nylon. Gerecycled Nylon Zakje.

 270 x 140 cm  20  Print Code: G(1), K(8), N(8)

RPET

Daltom 1570

Sleeping Bag. Polyester 190T RPET. Polyester RPET Pouch.
Schlafsack. Polyester 190T RPET. Polyester RPET Etui.
Sac couchage. Polyester 190T RPET. Étui Polyester RPET.
Slaapzak. Polyester 190T RPET. Polyester RPET Zakje.

 75 x 190 cm  10  Print Code: H(1), N(8)

Rebrax 1569

Tent. Polyester 190T RPET. Automontable. Polyester Pouch RPET.
Zelt. Polyester 190T RPET. Automontierbar. Polyester Etui RPET.
Tente. Polyester 190T RPET. Automontable. Étui Polyester RPET.
Tent. Polyester 190T RPET. Automontabel. Polyester Zakje RPET.

 150 x 110 x 150 cm  10  Print Code: K(8)





19



02



03

Virtux 7295



Backpack. Polyester 420D. Padded Back and Shoulder Straps.
Rucksack. Polyester 420D. Gepolsterter Rücken und Schultergurte.
Sac à Dos. Polyester 420D. Dos et Bretelles Rembourrées.
Rugzak. Polyester 420D. Gewatteerde Achterzijde en Schouderbanden.

35 x 53 x 28 cm 20 Print Code: J(8)

swisent
ORIZONS
adventure



16



Densul 6168

Backpack. Polyester 210D/ Ripstop. Padded Back and Shoulder Straps.
Rucksack. Polyester 210D/ Ripstop. Gepolsterter Rücken und Schultergurte.
Sac à Dos. Polyester 210D/ Ripstop. Dos et Bretelles Rembourrées.
Rugzak. Polyester 210D/ Ripstop. Gewatteerde Achterzijde en Schouderbanden.

32 x 47 x 28 cm 20 Print Code: H(1), N(8)



03



19



SOLAR
CHARGING
STATION



03

Rasmus 6329

Charger Backpack. Ripstop. Solar Panel 6.5W. USB Connection. Padded Laptop Compartment. Padded Back and Shoulder Straps.
Ladegerät Rucksack. Ripstop. Sonnenkollektor 6,5W. USB Anschluss. Gepolsterter Laptoptasche. Gepolsterter Rücken und Schultergurte.
Sac à Dos Chargeur. Ripstop. Panneau Solaire 6,5W. Connexion USB. Pochette Rembourrée pour Portable. Dos et Bretelles Rembourrées.
Oplader Rugzak. Ripstop. Zonnepaneel 6,5W. USB Verbinding. Gewatteerd Laptop Compartment. Gewatteerde Achterzijde en Schouderbanden.

33 x 52 x 23 cm 10 Print Code: J(8)



04

19



TABLET COMPARTMENT



LAPTOP COMPARTMENT



WATER RESISTANT

New



Sagan 20459

Cool Bag Chair. Polyester 600D RPET/ PEVA.
Stuhl Kühltasche. Polyester 600D RPET/ PEVA.
Chaise Glacière. Polyester 600D RPET/ PEVA.
Stoel-koeltas. Polyester 600D RPET/ PEVA.

31 x 42 x 35 cm 6 Print Code: N(8)



RPET ♻️

WATERPROOF

Bag & Backpack



20 L

03



New

25 L

04

Tayrux 6513

Backpack. Ripstop. 20 L. Waterproof.
Rucksack. Ripstop. 20 L. Wasserabweisende.
Sac à Dos. Ripstop. 20 L. Imperméable.
Rugzak. Ripstop. 20 L. Waterdicht.

☞ 23 × 63 cm ☞ 20 ☞ Print Code: H(1)



01

05

19

Ardentix 20464

Backpack. Polyester 300D RPET. 25 L. Waterproof. Touch Screen.
Rucksack. Polyester 300D RPET. 25 L. Wasserabweisende. Touch Screen.
Sac à Dos. Polyester 300D RPET. 25 L. Imperméable. Ecran Tactile.
Rugzak. Polyester 300D RPET. 25 L. Waterdicht. Touch Screen.

☞ 37 × 55 × 13 cm ☞ 30 / 10
☞ Print Code: H(1), N(8)



03

02

19

WATERPROOF

Bag & Backpack



9 L



03



01

02

04

05

19

Tinsul 4848

Bag, Ripstop, 9 L, Waterproof.
Tasche, Ripstop, 9 L, Wasserabweisende.
Sac, Ripstop, 9 L, Imperméable.
Tas, Ripstop, 9 L, Waterdicht.

📏 Ø 18.5 x 36 cm 📦 100 / 10 🖨️ Print Code: H(1)

2.3 L



03



01

02

05

19

Kinser 4847

Bag, Ripstop, 2.3 L, Waterproof.
Tasche, Ripstop, 2.3 L, Wasserabweisende.
Sac, Ripstop, 2.3 L, Imperméable.
Tas, Ripstop, 2.3 L, Waterdicht.

📏 Ø 11.5 x 26 cm 📦 200 / 10 🖨️ Print Code: H(1)

2 L



03



01

05

19

Kambax 6564

Bag, Ripstop, 2 L, Waterproof, Touch Screen.
Tasche, Ripstop, 2 L, Wasserabweisende, Touch Screen.
Sac, Ripstop, 2 L, Imperméable, Écran Tactile.
Tas, Ripstop, 2 L, Waterdicht, Touch Screen.

📏 Ø 11 x 29.5 cm 📦 200 / 10 🖨️ Print Code: H(1)

WATERPROOF Bag & Backpack

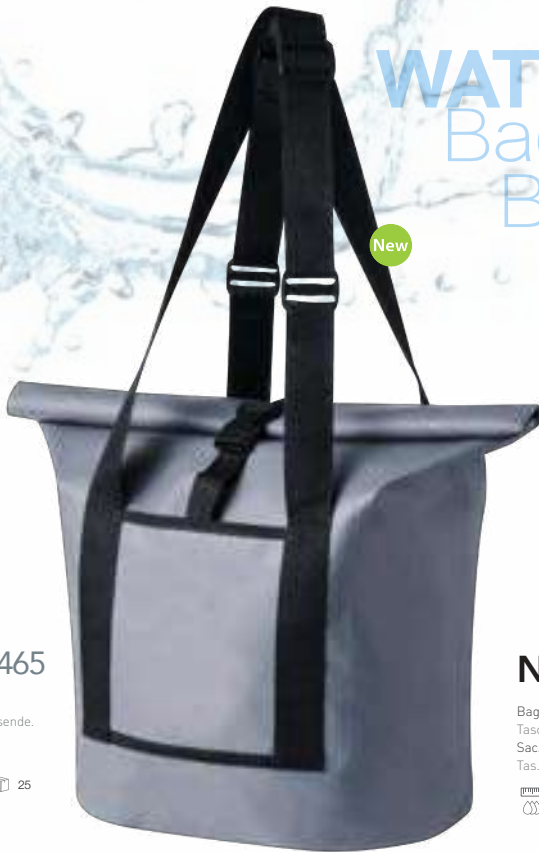

New

Jagsen 20465

Bag. PVC. Waterproof.
Tasche. PVC. Wasserabweisende.
Sac. PVC. Imperméable.
Tas. PVC. Waterdicht.

49 x 48 x 25 cm 25
Print Code: G(1)



New

Nandora 20466

Bag. PVC. Waterproof.
Tasche. PVC. Wasserabweisende.
Sac. PVC. Imperméable.
Tas. PVC. Waterdicht.

44.5 x 48 x 19 cm 25
Print Code: G(1)

WATERPROOF RPET



02 05 19

New

5 L



03

Veronia 20462

Bag. Polyester 300D RPET. 5 L. Waterproof.
Tasche. Polyester 300D RPET. 5 L. Wasserabweisende.
Sac. Polyester 300D RPET. 5 L. Imperméable.
Tas. Polyester 300D RPET. 5 L. Waterdicht.

17.5 x 35 cm 100 / 10
Print Code: G(1), N(8)

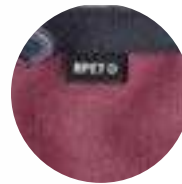

New

10 L



02 05 19

Kasolin 20463

Bag. Polyester 300D RPET. 10 L. Waterproof.
Tasche. Polyester 300D RPET. 10 L. Wasserabweisende.
Sac. Polyester 300D RPET. 10 L. Imperméable.
Tas. Polyester 300D RPET. 10 L. Waterdicht.

20 x 46 cm 50 / 10
Print Code: G(1), N(8)



03



03

Gimax 1663

Torch, Aluminium, 1 Led, 200 Lumens, Zoom, 3 Light Modes, Fixed and Flashing, 3 Batteries AA Not Included.

Lampe, Aluminium, 1 Led, 200 Lumen, Zoom, 3 Lichtpositionen, Festes und Blinkendes, 3 AA Batterien Nicht im Lieferumfang.

Lampe, Aluminium, 1 Led, 200 Lumens, Zoom, 3 Modes de Lumière, Fixe et Clignotante, 3 Piles AA Non Incluses.

Zaklamp, Aluminium, 1 Led, 200 Lumens, Zoom, 3 Licht Posities, Vast en Knipperend, 3 Batterijen AA Niet Inclusief.

📏 Ø 4.2 x 13.7 cm 📦 50 / 25 🖨️ Print Code: E(1), L1



Lumosh 7287

Torch, Aluminium, 9 Leds, 30 Lumens, 3 Batteries AAA Not Included.

Lampe, Aluminium, 9 Leds, 30 Lumen, 3 AAA Batterien Nicht im Lieferumfang.

Lampe, Aluminium, 9 Leds, 30 Lumens, 3 Piles AAA Non Incluses.

Zaklamp, Aluminium, 9 Leds, 30 Lumens, 3 Batterijen AAA Niet Inclusief.

📏 Ø 3.2 x 10 cm 📦 100 / 50 🖨️ Print Code: E(4), L1

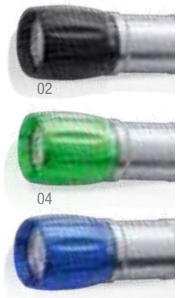

02

04

19



03



03

Vilox 6246

Torch, 8 COB Lights, 3 Light Modes, Fixed and Flashing, 3 Batteries AAA Not Included.

Lampe, 8 COB Lichter, 3 Lichtpositionen, Festes und Blinkendes, 3 AAA Batterien Nicht im Lieferumfang.

Lampe, 8 Lumières COB, 3 Modes de Lumière, Fixe et Clignotante, 3 Piles AAA Non Incluses.

Zaklamp, 8 COB Lichten, 3 Licht Posities, Vast en Knipperend, 3 Batterijen AAA Niet Inclusief.

📏 6.1 x 4 x 1.7 cm 📦 500 / 100 🖨️ Print Code: E(1)



19

02



01

04

Lokys 5148

Torch, Aluminium, 5 Leds, 3 Light Modes, Fixed and Flashing, 3 Batteries AAA Not Included.

Lampe, Aluminium, 5 Leds, 3 Lichtpositionen, Festes und Blinkendes, 3 AAA Batterien Nicht im Lieferumfang.

Lampe, Aluminium, 5 Leds, 3 Modes de Lumière, Fixe et Clignotante, 3 Piles AAA Non Incluses.

Zaklamp, Aluminium, 5 Leds, 3 Licht Posities, Vast en Knipperend, 3 Batterijen AAA Niet Inclusief.

📏 6 x 4.5 x 3.8 cm 📦 200 / 20 🖨️ Print Code: E(1)



09

19



IDEAL FOR
LASER ENGRAVING

Made in Europe

Tamdar 2688

Walking Pole. Wood.
Gehstock. Holz.
Bâton. Bois.
Wandelstok. Hout.

130 cm 50 / 25 Print Code: L2

Caterpil 1388

Walking Pole. Aluminium/ Cork. Foldable. Adjustable Height. Antishock. Snow Accessory. Non-Woven Pouch.
Gehstock. Aluminium/ Kork. Falten. Höhenverstellbar. AntiShock. Zubehör für Schnee. Non-Woven Etui Inklusiv.
Bâton. Aluminium/ Liège. Pliable. Hauteur Réglable. Antichoc. Accessoire Neige. Étui T.N.T.
Wandelstok. Aluminium/ Kurk. Opvouwbaar. Aanpasbaar Hoogte. Antishock. Sneeuw-Accessoir. Non-Woven Zakje.

135 cm 20 Print Code: G(1), L2, N(8)



TELESCOPIC

TELESCOPIC

Brulen 6492

Walking Poles Set. Aluminium. 2 Pieces. Foldable. Adjustable Height. Antishock. Snow Accessory. Polyester Pouch.
Wanderstöcke Set. Aluminium. 2 Stück. Faltbar. Höhenverstellbar. AntiShock. Zubehör für Schnee. Polyester Etui.
Set Bâtons. Aluminium. 2 Pièces. Pliable. Hauteur Réglable. Antichoc. Accessoire Neige. Étui Polyester.
Wandelstokken. Aluminium. 2 Stuks. Opvouwbaar. Aanpasbaar Hoogte. Antishock. Sneeuw-Accessoir. Polyester Zakje.

140 cm 20 Print Code: G(1), L2, N(8)



03

02



New

Neiru 20540

Emergency Kit. PP. 22 Accessories.
 Erste Hilfe Set. PP. 22 Teile.
 Kit Urgence. PP. 22 Accessoires.
 Ehbo-Set. PP. 22 Accessoires.

10 x 13.5 x 3 cm 100 Print Code: E(1)



New

Dorio 20541

Emergency Kit. PP. 7 Accessories.
 Erste Hilfe Set. PP. 7 Teile.
 Kit Urgence. PP. 7 Accessoires.
 Ehbo-Set. PP. 7 Accessoires.

5 x 9.5 x 2.5 cm 100 Print Code: D(1)



Redcross 9496

Emergency Kit. Polyester 600D. 17 Accessories.
 Erste Hilfe Set. Polyester 600D. 17 Teile.
 Kit Urgence. Polyester 600D. 17 Accessoires.
 Ehbo-Set. Polyester 600D. 17 Accessoires.

18 x 12 x 6 cm 100 / 20 Print Code: E(1)



02

Brinek 1478

Raincoat. LDPE. One Size. Adult. 127 x 102 cm. Polyester RPET Pouch.
 Poncho. LDPE. Einheitsgröße. Erwachsene. 127 x 102 cm. Polyester RPET Etui.
 Poncho. LDPE. Taille Unique. Adulte. 127 x 102 cm. Etui Polyester RPET.
 Regenjas. LDPE. Eén Maat. Volwassen. 127 x 102 cm. Polyester RPET Zakje.

8 x 8 x 2.5 cm 200 / 25 Print Code: E(1)



19

04



Quint 4915

Space Blanket. Metallized PET.
 Rettungsdecke. Aluminiumiertes PET.
 Couverture Thermique. PET Aluminisé.
 Heelal Deken. Aluminium Coated PET.

210 x 130 cm 200 / 50 Print Code: D(1)

210 ml



19

Bastic 4509

Mug. Stainless Steel. 210 mL.
Tasse. Rostfreier Stahl. 210 mL.
Tasse. Acier Inox. 210 mL.
Mok. Roestvrij Staal. 210 mL.

☞ Ø 7 x 8 cm ☞ 50
☞ Print Code: F(1), L1



New

300 ml



03

Lecrer 20456

Mug. Recycled Stainless Steel. 300 mL.
Tasse. Recycling Rostfreier Stahl. 300 mL.
Tasse. Acier Inox Recyclé. 300 mL.
Mok. Gerecycled Roestvrij Staal. 300 mL.

☞ Ø 7.6 x 9 cm ☞ 50 ☞ Print Code: F(1), L1



220 ml

New



145 ml

Daibak 1730

Foldable Cup. Stainless Steel. 220 mL.
Faltbarer Trinkbecher. Rostfreier Stahl. 220 mL.
Verre Pliable. Acier Inox. 220 mL.
Opvouwbare Beker. Roestvrij Staal. 220 mL.

☞ Ø 7.8 x 8 cm ☞ 100 / 50 ☞ Print Code: E(1), L1

Melbour 20457



Mug. Stainless Steel. 145 mL.
Tasse. Rostfreier Stahl. 145 mL.
Tasse. Acier Inox. 145 mL.
Mok. Roestvrij Staal. 145 mL.

☞ Ø 7 x 7.2 cm ☞ 50 ☞ Print Code: F(1), L1



Sondic 1571

Kitchenware Camping Set. Stainless Steel/ Aluminium. 5
Accessories. Polyester RPET Pouch.
Kochgeschirr Camping Set. Rostfreier Stahl/ Aluminium. 5 Teile.
Polyester RPET Etui.
Set Ustensiles Camping. Acier Inox/ Aluminium. 5 Accessoires. Étui
Polyester RPET.
Keukengerie Camping Set. Roestvrij Staal/ Aluminium. 5
Accessoires. Polyester RPET Zakje.

☞ Ø 13 x 15.3 cm ☞ 20 ☞ Print Code: G(1), L2



RPET



Zaralex 1114

Picnic Blanket. Polyester RPET 160 g/ m².
 Picnic Decke. Polyester RPET 160 g/ m².
 Couverture Picnic. Polyester RPET 160 g/ m².
 Picnic Deken. Polyester RPET 160 g/ m².

150 x 120 cm

150 x 120 cm 20 Print Code: F(1), N(8), P

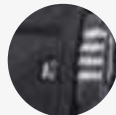

MADE FROM
 -RECYCLED-
 LEATHER RPET



Pirsoy 1567

Picnic Blanket. Recycled Leather/ PEVA/ Polyester RPET 160 g/ m².
 Picnic Decke. Recycling Leder/ PEVA/ Polyester RPET 160 g/ m².
 Couverture Picnic. Cuir Recyclé/ PEVA/ Polyester RPET 160 g/ m².
 Picnic Deken. Gerecycled Leer/ PEVA/ Polyester RPET 160 g/ m².

150 x 120 cm

150 x 120 cm 20 Print Code: F(1), N(8)

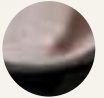

19

03

04

New

Zoran 20460

Picnic Blanket. Polyester 210D/ Polar Fleece 190 g/ m².
 Picnic Decke. Polyester 210D/ Polar Fleece 190 g/ m².
 Couverture Picnic. Polyester 210D/ Polaire 190 g/ m².
 Picnic Deken. Polyester 210D/ Polar Fleece 190 g/ m².

150 x 120 cm 20 Print Code: N(8), P



150 x 120 cm

RPET

New

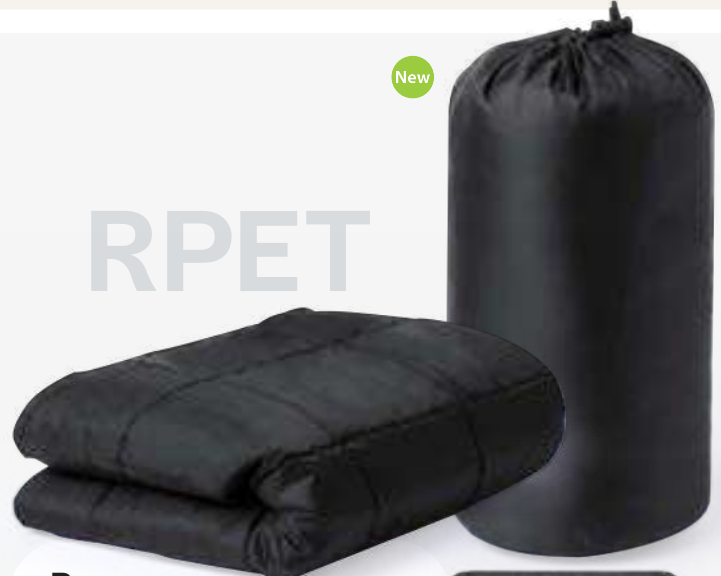

Barea 20461

Picnic Blanket. Polyester RPET 160 g/ m².
 Picnic Decke. Polyester RPET 160 g/ m².
 Couverture Picnic. Polyester RPET 160 g/ m².
 Picnic Deken. Polyester RPET 160 g/ m².

150 x 120 cm 20 Print Code: F(1), N(8), O, P



150 x 120 cm

RPET



Kazor 6917

Picnic Cool Bag Backpack. Polyester 600D RPET/ PEVA. 12 Pieces. 2 Services. Padded Back and Shoulder Straps.
 Picnic Kühltasche Rucksack. Polyester 600D RPET/ PEVA. 12 Stück. 2 Personen. Gepolsterter Rücken und Schultergurte.
 Sac à Dos Glacière Picnic. Polyester 600D RPET/ PEVA. 12 Pièces. 2 Services. Dos et Bretelles Rembourrées.
 Picnic Koeltas-Rugzak. Polyester 600D RPET/ PEVA. 12 Stuks. 2 Service. Gewatteerde Achterzijde en Schouderbanden.

📏 27 x 37 x 22 cm 📦 10 🖨️ Print Code: N(8)

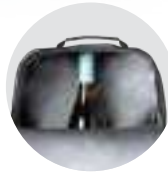

Shira 20467

Picnic Cool Bag Backpack. Polyester 600D RPET/ PEVA. 10 Pieces. 2 Services. Padded Back and Shoulder Straps.
 Picnic Mochila Nevera. Polyester 600D RPET/ PEVA. 10 Stück. 2 Personen. Gepolsterter Rücken und Schultergurte.
 Sac à Dos Glacière Picnic. Polyester 600D RPET/ PEVA. 10 Pièces. 2 Services. Dos et Bretelles Rembourrées.
 Picnic Koeltas-Rugzak. Polyester 600D RPET/ PEVA. 10 Stuks. 2 Service. Gewatteerde Achterzijde en Schouderbanden.

📏 29 x 44 x 23 cm 📦 5 🖨️ Print Code: N(8)



New

RPET

Cool Bag Backpack



Seyman 1568

Picnic Cool Bag Backpack. Polyester RPET/ PEVA. 32 Pieces. 4 Services. Padded Back and Shoulder Straps. Picnic Blanket Polyester 600D RPET 160 g/ m2 Included.
 Picnic Kühltasche Rucksack. Polyester RPET/ PEVA. 32 Stück. 4 Personen. Gepolsterter Rücken und Schultergurte. Picnic Decke Polyester 600D RPET 160 g/ m2 Inklusiv.
 Sac à Dos Glacière Picnic. Polyester RPET/ PEVA. 32 Pièces. 4 Services. Dos et Bretelles Rembourrées. Couverture Picnic Polyester 600D RPET 160 g/ m2 Incluse.
 Picnic Koeltas-Rugzak. Polyester RPET/ PEVA. 32 Stuks. 4 Service. Gewatteerde Achterzijde en Schouderbanden. Picnic Deken Polyester 600D RPET 160 g/ m2 Inclusief.

📏 29 x 40 x 26 cm 📦 5 🖨️ Print Code: I(8)



120 X 150 CM

Niobex 1120

Hammock. Canvas. Canvas Pouch.
Hängematte. Canvas. Canvas Etui.
Hamac. Toile. Étui Toile.
Hangmat. Canvas. Canvas Zakje.

190 x 80 cm 10 Print Code: G(1), K(8), N(8)

Laudan 20468

Picnic Basket. Cotton/ Wicker. 12 Pieces. 2 Services.
Picnic Tasche. Baumwolle/ Weide. 12 Stück. 2 Personen.
Sac Picnic. Coton/ Osier. 12 Pièces. 2 Services.
Picnic Tasje. Katoen/ Rieten. 12 Stuks. 2 Service.

35 x 42 x 21 cm 10 Print Code: I(8), L2

New

Midland 1490

Thermal Picnic Basket. Wicker/ Polyester/ Aluminium. 12 Pieces. 2 Services.
Picnic Wärme Tasche. Weide/ Polyester/ Aluminium. 12 Stück. 2 Personen.
Sac Thermique Picnic. Osier/ Polyester/ Aluminium. 12 Pièces. 2 Services.
Picnic Thermo-Tasje. Rieten/ Polyester/ Aluminium. 12 Stuks. 2 Service.

39 x 26 x 19 cm 4 Print Code: K(1), L2





Halbax 1772

Thermal Picnic Basket. Wicker/ Cotton/ Aluminium.
 Picnic Wärme Tasche. Weide/ Baumwolle/ Aluminium.
 Sac Thermique Picnic. Osier/ Coton/ Aluminium.
 Picnic Thermo-Tasje. Rieten/ Katoen/ Aluminium.

41 x 31.5 x 27 cm 4 Print Code: I(1), L2



Bubu 1729

Thermal Picnic Basket. Wicker/ Aluminium/ Bamboo.
 Picnic Wärme Tasche. Weide/ Aluminium/ Bambus.
 Sac Thermique Picnic. Osier/ Aluminium/ Bambou.
 Picnic Thermo-Tasje. Rieten/ Aluminium/ Bamboe.

Ø 32 x 25.5 cm 4 Print Code: I(1), L2



Zarbok 1232

Table. Bamboo. Foldable.
 Tisch. Bambus. Faltbar.
 Table. Bambou. Pliable.
 Tafel. Bamboe. Opvouwbaar.

40 x 29.5 x 18.5 cm 8 Print Code: J(1), L2



Scotty 1737

Picnic Set. Cotton. 12 Pieces. 2 Services.
 Picnic Set. Baumwolle. 12 Stück. 2 Personen.
 Set Picnic. Coton. 12 Pièces. 2 Services.
 Picnic Set. Katoen. 12 Stuks. 2 Service.

Ø 26.5 x 6 cm 10 Print Code: L1, N(8)





Tilken 1572

Picnic Set. Polyester 600D RPET. 13 Pieces. 2 Services.
 Picnic Set. Polyester 600D RPET. 13 Stück. 2 Personen.
 Set Picnic. Polyester 600D RPET. 13 Pièces. 2 Services.
 Picnic Set. Polyester 600D RPET. 13 Stuks. 2 Service.

24.5 x 24.5 x 4.5 cm 20 Print Code: F(1), N(8)



Tailung 1067

Cutlery Set. Stainless Steel. 5 Pieces. Polyester RPET Pouch.
 Besteckset. Rostfreier Stahl. 5 Stück. Polyester RPET Etui.
 Set Couverts. Acier Inox. 5 Pièces. Étui Polyester RPET.
 Bestek Set. Roestvrij Staal. 5 Stuks. Polyester RPET Zakje.

7.5 x 24.5 x 2 cm 80 / 40 Print Code: G(1), L1, N(8)



Dorothy 1731

Basket. Polyester 600D RPET. Foldable.
 Tasche. Polyester 600D RPET. Faltbar.
 Sac. Polyester 600D RPET. Pliable.
 Tasje. Polyester 600D RPET. Opvouwbaar.

46 x 26 x 29 cm 10 Print Code: H(1), N(8)



FOLDABLE



Kemper 1096

Cool Bag Backpack. Polyester 600D RPET/ PEVA. Padded.
 Kühltasche Rucksack. Polyester 600D RPET/ PEVA. Gepolstert.
 Sac à Dos Glacière. Polyester 600D RPET/ PEVA. Rembourré.
 Koeltas-Rugzak. Polyester 600D RPET/ PEVA. Gewatteerd.

21 x 38 x 17 cm 20 Print Code: G(1), N(8)





Briant 1800

Thermal Picnic Basket. PP. Foldable.
Picnic Wärme Tasche. PP. Faltbar.
Sac Thermique Picnic. PP. Pliable.
Picnic Thermo-Tasje. PP. Opvouwbaar.

47 x 24 x 29 cm 8 Print Code: K(1)



Flentul 5489

Chair. Polyester 600D. Foldable. Polyester Pouch.
Stuhl. Polyester 600D. Faltbar. Polyester Etui.
Chaise. Polyester 600D. Pliable. Étui Polyester.
Stoel. Polyester 600D. Opvouwbaar. Polyester Zakje.

45 x 70 x 45 cm 10
 Print Code: H(1), N(8)



Bonsix 5488

Chair. Polyester 600D. Foldable. Polyester Pouch.
Stuhl. Polyester 600D. Faltbar. Polyester Etui.
Chaise. Polyester 600D. Pliable. Étui Polyester.
Stoel. Polyester 600D. Opvouwbaar. Polyester Zakje.

83 x 79 x 49 cm 6 Print Code: H(1), N(8)



RPET



Arcadia 1491

Barbecue Set. Polyester 300D RPET/ PEVA. 3 Accessoires.
 Grillset. Polyester 300D RPET/ PEVA. 3 Teile.
 Set Barbecue. Polyester 300D RPET/ PEVA. 3 Accessoires.
 Barbecue Set. Polyester 300D RPET/ PEVA. 3 Accessoires.

25 x 38 x 20 cm 10 Print Code: N(8)



Hermut 1231

Barbecue. Metal. Foldable.
 Grill. Metall. Faltbar.
 Barbecue. Métal. Pliable.
 Barbecue. Metaal. Opvouwbaar.

44 x 28.5 x 36.7 cm 4 Print Code: J(1), L2



Priya 1392

Log Carrier. Polyester 600D.
 Holzträger. Polyester 600D.
 Porte Buches. Polyester 600D.
 Log Carrier. Polyester 600D.

46 x 99 cm 50 Print Code: G(1), N(8), O, P



Mayrax 1230

Barbecue. Metal.
 Grill. Metall.
 Barbecue. Métal.
 Barbecue. Metaal.

Ø 36 x 36 cm 4 Print Code: J(1)





Craxton 1112

Barbecue Set. Wood/ Stainless Steel/ Bamboo. 6 Accessoires. Polyester Pouch.

Grillset. Holz/ Rostfreier Stahl/ Bambus. 6 Teile. Polyester Etui.

Set Barbecue. Bois/ Acier Inox/ Bambou. 6 Accessoires. Étui Polyester.

Barbecue Set. Hout/ Roestvrij Staal/ Bamboe. 6 Accessoires. Polyester Zakje.

📏 36.8 x 24 x 4 cm 📦 10 🖨️ Print Code: N(8), L2



Estrol 20469

Barbecue Set. Stainless Steel/ Bamboo. 7 Accessoires. Polyester Pouch.

Grillset. Rostfreier Stahl/ Bambus. 7 Teile. Polyester Etui.

Set Barbecue. Acier Inox/ Bambou. 7 Accessoires. Étui Polyester.

Barbecue Set. Roestvrij Staal/ Bamboe. 7 Accessoires. Polyester Zakje.

📏 42 x 22 x 5 cm 📦 10 🖨️ Print Code: L2, N(8)



North 3382

Barbecue Set. Stainless Steel/ Polyester 600D. 7 Accessoires.

Grillset. Rostfreier Stahl/ Polyester 600D. 7 Teile.

Set Barbecue. Acier Inox/ Polyester 600D. 7 Accessoires.

Barbecue Set. Roestvrij Staal/ Polyester 600D. 7 Accessoires.

📏 43 x 60 cm 📦 20 🖨️ Print Code: I(8)



Raiken 20470

Barbecue Set. Stainless Steel. 11 Accessoires. Polyester Pouch.

Grillset. Rostfreier Stahl. 11 Teile. Polyester Etui.

Set Barbecue. Acier Inox. 11 Accessoires. Étui Polyester.

Barbecue Set. Roestvrij Staal. 11 Accessoires. Polyester Zakje.

📏 38 x 10 x 10 cm 📦 10

🖨️ Print Code: N(8), F(1)

Lenvit 1111



Barbecue Set. Bamboo/ Stainless Steel. 3 Accessoires.

Grillset. Bambus/ Rostfreier Stahl. 3 Teile.

Set Barbecue. Bambou/ Acier Inox. 3 Accessoires.

Barbecue Set. Bamboe/ Roestvrij Staal. 3 Accessoires.

📏 43 x 14.5 x 7 cm 📦 10 🖨️ Print Code: E(1), L2



13 URBAN TRAVEL





Jamet 21024

Hair Trimmer; 3 Accessories. 1 Battery AA Not Included.
Haarschneider; 3 Teile. 1 AA Batterie Nicht im Lieferumfang.
Tondeuse à Cheveux; 3 Accessoires. 1 Pile AA Non Inclusive.
Haartrimmer; 3 Accessoires. 1 Batterij AA Niet Inclusief.

3.2 x 10.5 x 4.3 cm 50 / 25 Print Code: F(4)



Kiop 20366

Iron. 25W. AC 220-240V.
Bügeleisen. 25W. AC 220-240V.
Fer à Repasser. 25W. AC 220-240V.
Strijkijzer. 25W. AC 220-240V.

10.6 x 6.5 x 6.3 cm 30 Print Code: F(1)



Guyit 20365

Lint Remover. 2 Batteries AA Not Included.
Flusen Entferner. 2 AA Batterien Nicht im Lieferumfang.
Rouleau Anti-Peluche. 2 Piles AA Non Inclusive.
Pluizenverwijderaar. 2 Batterijen AA Niet Inclusief.

7.3 x 15.3 x 7.1 cm 40 Print Code: F(4)



Cloris 3816

Luggage Tag.
Kofferanhänger.
Identificateur Valise.
Bagage Label.

27 x 13 cm 5.5 x 9.5 x 0.4 cm

400 / 50

Print Code: B(4)



19



06



19

Lisboa 9188

Travel Document Holder. Polyester 600D.
Reise Dokumententasche. Polyester 600D.
Porte-Documents Voyage. Polyester 600D.
Reisdocumentenhouder. Polyester 600D.

27 x 13 cm 400 / 40

Print Code: E(1), N(8)



Farrel 1626

Travel Document Holder. Polyester 600D/ PU.
Reise Dokumententasche. Polyester 600D/ PU.
Porte-Documents Voyage. Polyester 600D/ PU.
Reisdocumentenhouder. Polyester 600D/ PU.

25 x 13.5 cm 100 / 25

Print Code: E(1), N(8)



Luggage Tag



New

Filip 20349

Luggage Tag, Felt RPET.
Kofferanhänger, Filz RPET.
Identificateur Valise, Feutrine RPET.
Bagage Label, Vilt RPET.

6.3 x 11 x 0.6 cm 1000 / 100 Print Code: C(1), N(8)



New

Holda 20350

Luggage Tag, Bamboo/ Silicone.
Kofferanhänger, Bambus/ Silikon.
Identificateur Valise, Bambou/ Silicone.
Bagage Label, Bamboe/ Siliconen.

6 x 9 x 0.6 cm 500 / 50 Print Code: B(4), L1



Elwes 1625

Luggage Tag, Bamboo.
Kofferanhänger, Bambus.
Identificateur Valise, Bambou.
Bagage Label, Bamboe.

4.9 x 9 x 0.2 cm 1000 / 250 Print Code: B(4), L1



Cliffer 1623

Luggage Tag, Wheat Straw/ ABS.
Kofferanhänger, Weizenstroh/ ABS.
Identificateur Valise, Paille de Blé/ ABS.
Bagage Label, Tarwestro/ ABS.

5.5 x 9.5 x 0.4 cm 500 / 50 Print Code: B(4)

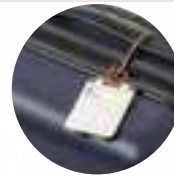

Dastin 1624

Luggage Tag, Cork.
Kofferanhänger, Kork.
Identificateur Valise, Liège.
Bagage Label, Kurk.

6.4 x 9.5 x 0.4 cm 500 / 50 Print Code: B(4), L1

SELF-INFLATABLE

New



Balum 20360

Pillow, Polyester, Self-Inflatable, Polyester RPET Pouch.
 Kissen, Polyester, Selbstaufblasbar, Polyester RPET Étui.
 Coussin, Polyester, Autogonflable, Étui Polyester RPET.
 Kussen, Polyester, Zelfopblaasbaar, Polyester RPET Zakje.

47 × 8 × 28.5 cm 50 Print Code: G(1), N(8)



RPET 

COMFORT



Blaiser 20351

Pillow, Polyester, Polyester RPET Pouch.
 Kissen, Polyester, Polyester RPET Étui.
 Coussin, Polyester, Étui Polyester RPET.
 Kussen, Polyester, Polyester RPET Zakje.

24.5 × 12 × 25 cm 20 Print Code: G(1), N(8)



RPET 



08



04



03



19

Condord 5556

Pillow, Polyester, EPS Filling.
 Kissen, Polyester, EPS-Füllung.
 Coussin, Polyester, Remplissage EPS.
 Kussen, Polyester, EPS-Vulling.

30 × 9.5 × 29 cm 20 Print Code: N(8)



RPET



New



Plonet 4171

Travel Set. Microfibre/ EVA. 3 Accessoires. Velvet Pouch.
Reise Set. Mikrofaser/ EVA. 3 Teile. Wildleder Etui.
Set Voyage. Microfibre/ EVA. 3 Accessoires. Étui Suééine.
Reis Set. Microfibre/ EVA. 3 Accessoires. Fluwel Zakje.

17,5 x 11 cm 100 / 20 Print Code: G(1), N(8)

Alkes 20361

Travel Set. Polyester. 3 Accessoires. Slippers Anti-Slip. One Size 36-43. Polyester RPET Pouch.
Reise Set. Polyester. 3 Teile. Pantoffeln Rutschfest. Einheitsgrösse 36-43. Polyester RPET Etui.
Set Voyage. Polyester. 3 Accessoires. Pantoufles Antidérapant. Taille Unique 36-43. Étui Polyester RPET.
Reis Set. Polyester. 3 Accessoires. Slippers Anti-Slip. Eén Maat 36-43. Polyester RPET Zakje.

12 x 18 x 8 cm 50 Print Code: G(1), N(8)





19

Traveller 8772

Pillow, Microfibre.
Kissen, Mikrofaser.
Coussin, Microfibre.
Kussen, Microfibre.

33 x 9 x 25 cm 200 / 20
Print Code: F(1), N(6)



RPET



06



08

Buxtok 1621

Travel Eye Mask, Polyester RPET, Polyester RPET Pouch.
Reise Augenmaske, Polyester RPET, Polyester RPET Etui.
Masque Voyage, Polyester RPET, Étui Polyester RPET.
Slapmasker, Polyester RPET, Polyester RPET Zakje.

18.5 x 9 cm 1000 / 100 Print Code: D(1), N(6)



08



02

Vildex 1622

Pillow, Polyester RPET, Polyester RPET Pouch.
Kissen, Polyester RPET, Polyester RPET Etui.
Coussin, Polyester RPET, Étui Polyester RPET.
Kussen, Polyester RPET, Polyester RPET Zakje.

17.5 x 11 cm 100 Print Code: F(1), N(6)



06

02



Brenda 1648

Eye Mask. Satin. Satin Pouch.
Augenmaske. Satin. Satin Etui.
Masque. Satiné. Étui Satiné.
Slaapmasker. Satijn. Satijn Zakje.

20 x 10 cm 500 / 50 Print Code: D(1), N(8)



06

Bezz 20352

Travel Eye Mask. Polyester.
Reise Augenmaske. Polyester.
Masque Voyage. Polyester.
Slaapmasker. Polyester.

23.5 x 8.5 cm 400 / 100 Print Code: D(1), N(8)



02



08



Asleep 9800

Travel Eye Mask. Microfibre.
Reise Augenmaske. Mikrofaser.
Masque Voyage. Microfibre.
Slaapmasker. Microfibre.

18.5 x 9 cm 1000 / 100 Print Code: D(1), N(8)

Yorder 4998

Travel Set. Microfibre/ EVA. 2 Accessories.
Reise Set. Mikrofaser/ EVA. 2 Teile.
Set Voyage. Microfibre/ EVA. 2 Accessoires.
Reis Set. Microfibre/ EVA. 2 Accessoires.

19 x 9 cm 500 / 100
Print Code: D(1), N(8)

Ranta 20740

Sublimation Travel Eye Mask. Soft Shell.
Sublimations Reise Augenmaske. Soft Shell.
Masque Voyage Sublimation. Soft Shell.
Sublimatie Slaapmasker. Soft Shell.

18.5 x 8 cm 1000 / 50 Print Code: R

Check for more than one color printing
Consultar impresión a más de un color



Panoss 4677

Earplugs. EVA.
Ohrstopfeln. EVA.
Bouchons Antibruit. EVA.
Oordopjes. EVA.

📏 Ø 2.2 x 6.4 cm 📦 1000 / 200 🖨️ Print Code: C(1)



19



Flaut 6104

Beauty Bag Travel. PVC/ PP. 5 Accessories.
Reise Kosmetik Tasche. PVC/ PP. 5 Teile.
Nécessaire Voyage. PVC/ PP. 5 Accessoires.
Toilettas. PVC/ PP. 5 Accessoires.

📏 20 x 18 x 4 cm 📦 100 🖨️ Print Code: F(1)



100ML



Travel Set

New



Essential Kit 1643

Set. Comb Wheat Straw/ PP. Toothbrush Wheat Straw/ PP. Toothpaste 6 gr.
Bar Soap 20 gr.
Set. Kamm Weizenstroh/ PP. Zahnbürste Weizenstroh/ PP. Zahnpaste 6 gr.
Seifenstück 20 gr.
Set. Peigne Paille de Blé/ PP. Brosse à Dents Paille de Blé/ PP. Dentifrice 6 gr.
Savon 20 gr.
Set. Kam Tarwestro/ PP. Tandenborstel Tarwestro/ PP. Tandpasta 6 gr. Stuk
Zeep 20 gr.

📏 14.5 x 2.5 x 4.7 cm 📦 200 / 50 🖨️ Print Code: C(1), B(4)

Atriax 20353

Sewing Kit. Bamboo. Mirror Included.
Nähset Kit. Bambou. Spiegel Inklusiv.
Set Coûture. Bambou. Miroir Inclusie.
Naaiset. Bamboe. Spiegel Inclusief.

📏 Ø 7.4 x 2 cm 📦 200 / 50 🖨️ Print Code: E(4), L2, W

Aeron 20356

Shoe Cleaning Set. 5 Accessories. Polyester RPET Pouch.
Schuhputzset. 5 Teile. Polyester RPET Etui.
Set de cirage. 5 Accessoires. Étui Polyester RPET.
Schoonmaakset voor Schoenen. 5 Accessoires. Polyester RPET Zakje.

📏 16 x 5 x 8.5 cm 📦 50 / 25 🖨️ Print Code: E(1), N(8)

WHEAT
STRAW

New



New



Avery 20270

PD
POWER
DELIVERY

USB Charger. Wheat Straw/ ABS. Fast Charger. 1 USB Output and 1 Type C Output.
USB Ladegerät. Weizenstroh/ ABS. Schnelle Aufladung. 1 USB Ausgang und 1 Typ C Ausgang.
Chargeur USB. Paille de Blé/ ABS. Charge Rapide. 1 Sortie USB et 1 Sortie Type C.
USB Oplader. Tarwestro/ ABS. Snellader. 1 USB Output en 1 Typ C Output.

100/50 3.9 x 8 x 2.6 cm

100/50

Print Code: D(4), W

Pylot 20291

PD
POWER
DELIVERY

IN/OUT
TYPE C

2 in 1
MICRO USB &
LIGHTNING

Chargers Set. Wheat Straw/ ABS. USB Charger Fast Charger, 1 USB Output and 1 Type C Output. Charging Cable Suitable for data transfer, Extendable Cable, Micro USB, Type C and Lightning Connection 9V DC 2.1A. Cotton Pouch.

Ladegerät Set. Weizenstroh/ ABS. USB Ladegerät Schnelle Aufladung, 1 USB Ausgang und 1 Typ C Ausgang. Ladegerät kabel Geeignet für die datenübertragung, Ausziehbares Kabel, Anschluss Micro USB, Typ C und Lightning 9V DC 2.1A. Baumwolle Etui.

Set Chargeurs. Paille de Blé/ ABS. Chargeur USB Charge Rapide, 1 Sortie USB et 1 Sortie Type C. Câble de Charge Convient au transfert de données, Câble Extensible, Connexion Micro USB, Type C et Lightning 9V DC 2.1A. Étui Coton.

USB Opladers. Tarwestro/ ABS. USB Oplader Snellader, 1 USB Output en 1 Typ C Output. Oplaadkabel Geschikt voor data-overdracht, Verlengbare Kabel, Micro USB, Type C en Lightning Connectie 9V DC 2.1A. Katoen Zakje.

100/50 10 x 15 x 3 cm

100/50

Print Code: E(4), F(1), N(8), W

Universal Trip Adapter

6700
mAh

Teimpor 6141

Multifunction Travel Adapter. Wireless Charger 5W. Power Bank 6700 mAh. 2 USB Outputs and 1 Type C Output. Type C Input. USA, Europe, Asia, UK, Australia.
 Multifunktions Reise Adapter. Drahtlos Ladegerät 5W. Power Bank 6700 mAh. 2 USB Ausgänge und 1 Typ C Ausgang. Typ C Eingang. USA, Europa, Asien, UK, Australien.
 Adaptateur Voyage Multifonction. Chargeur Sans Fil 5W. Power Bank 6700 mAh. 2 Sorties USB et 1 Sortie Type C. Entrée Type C. USA, Europe, Asie, Royaume-Uni, Australie.
 Multifunctioneel Reis Adapter. Draadloos Oplader 5W. Power Bank 6700 mAh. 2 USB Outputs en 1 Typ C Output. Typ C Input. USA, Europa, Azië, UK, Australië.

2.9 x 8 x 8 cm 40 Print Code: E(4), W



New

10000
mAh

COMPATIBLE WITH
MAGSAFE & Qi
TECHNOLOGY

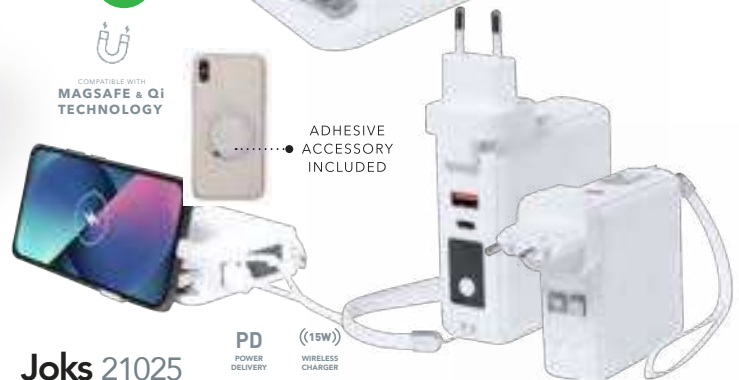

ADHESIVE
ACCESSORY
INCLUDED

PD
POWER
DELIVERY(15W)
WIRELESS
CHARGER

Joks 21025

Multifunction Travel Adapter. Wireless Charger 15W. Magnetic. Power Bank 10000 mAh. 2 Type C Outputs, 1 Micro USB/ Lightning Output and 1 USB Output. Type C Input. USA, Europe, Asia, UK, Australia.
 Multifunktions Reise Adapter. Drahtlos Ladegerät 15W. Magnetisch. Power Bank 10000 mAh. 2 Typ C Ausgänge, 1 Micro USB/ Lightning Ausgang und 1 USB Ausgang. Typ C Eingang. USA, Europa, Asien, UK, Australien.
 Adaptateur Voyage Multifonction. Chargeur Sans Fil 15W. Magnétique. Power Bank 10000 mAh. 2 Sorties Type C, 1 Sortie Micro USB/ Lightning et 1 Sortie USB. Entrée Type C. USA, Europe, Asie, Royaume-Uni, Australie.
 Multifunctioneel Reis Adapter. Draadloos Oplader 15W. Magnetisch. Power Bank 10000 mAh. 2 Typ C Outputs, 1 Micro USB/ Lightning Output en 1 USB Output. Typ C Input. USA, Europa, Azië, UK, Australië.

8.4 x 8.4 x 3.4 cm 40 / 20 Print Code: E(4), W



Universal Trip Adapter



New

Beigar 1627 PD POWER DELIVERY

Plug Adapter: 1 USB and 1 Type C Output. USA, Europe, Asia, UK, Australia. Velvet Pouch.
Steckeradapter: 1 USB und 1 Typ C Ausgänge. USA, Europa, Asien, UK, Australien. Wildleder Etui.
Adaptateur Prises: 1 Sortie USB et 1 Type C. USA, Europe, Asie, Royaume-Uni, Australie. Étui Suédoine.
Stekker Adapter: 1 USB en 1 Typ C Output. USA, Europa, Azië, UK, Australië. Fluweel Zakje.

5 × 6.1 × 5.7 cm 100 / 50 Print Code: E(4), N(8), W

Vlind 20364

Plug Adapter: USB and Type C Output. USA, Europe, Asia, UK, Australia.
Steckeradapter: USB und Typ C Ausgang. USA, Europa, Asien, UK, Australien.
Adaptateur Prises: Sortie USB et Type C. USA, Europe, Asie, Royaume-Uni, Australie.
Stekker Adapter: USB en Type C Output. USA, Europa, Azië, UK, Australië.

3 × 5.4 × 4.7 cm 100 / 50 Print Code: E(4), W

Explorer

discover

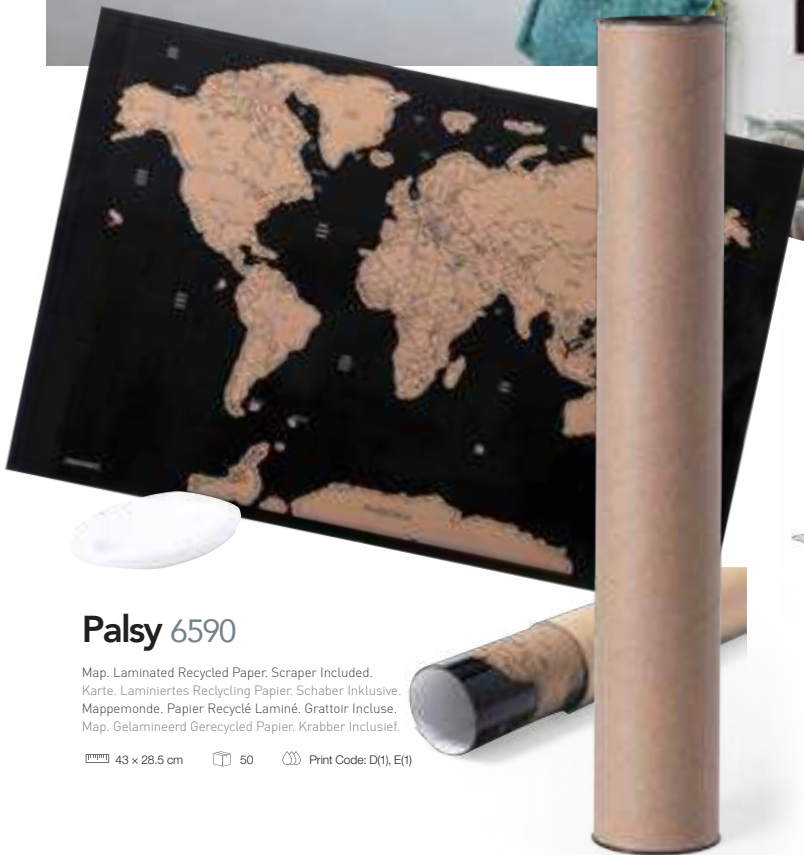

Palsy 6590

Map. Laminated Recycled Paper. Scraper Included.
Karte. Laminiertes Recycling Papier. Schaber Inklusiv.
Mappemonde. Papier Recyclé Laminé. Grattoir Inclusif.
Map. Gelamineerd Gerecycled Papier. Krabber Inclusief.

43 x 28.5 cm 50 Print Code: D(1), E(1)



Munds 6579

Globe. Cork/ Metal. 12 Markers Included.
Erdbugel. Kork/ Metall. 12 Marker Inklusiv.
Globe Terrestre. Liège/ Métal. 12 Marqueurs Incluses.
Wereldbol Globe. Kurk/ Staal. 12 Stiften inclusief.

Ø 15 x 20 cm 10 Print Code: G(1), L1



Blanax 4424

Luggage Scales. Max 40 Kg. Button Battery Included.
Gepäckwaage. Max 40 Kg. Knopfzelle Inklusive.
Pèse-Bagages. Max 40 Kg. Pile Bouton Incluse.
Bagage Weegschaal. Max 40 Kg. Knopcel Batterij Inclusief.

10 × 18 × 3.7 cm 150 / 50 Print Code: D(4)

03

19

01

05

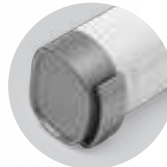

Daley 20363

Luggage Scales. Max 50 Kg. Button Battery Included.
Gepäckwaage. Max 50 Kg. Knopfzelle Inklusive.
Pèse-Bagages. Max 50 Kg. Pile Bouton Incluse.
Bagage Weegschaal. Max 50 Kg. Knopcel Batterij Inclusief.

3.4 × 13.5 × 2.6 cm 100 / 50 Print Code: E(4)

New



05



19



02

03

01

19



03

05

09

01

02

Ripley 5373

Luggage Strap. Polyester.
Koffer Band. Polyester.
Sangle Bagage. Polyester.
Koffer Riem. Polyester.

180 × 5 cm 100 / 20
Print Code: E(1)



Zanex 4377

Padlock. Metal.
Kofferschloss. Metall.
Cadenas. Métal.
Hangslot. Metaal.

2 × 6.5 × 0.8 cm 500 / 50
Print Code: D(4), L1

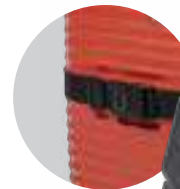
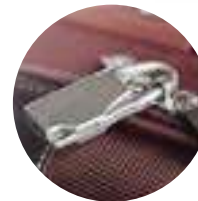

New



Chengu 20359

Luggage Strap. Polyester. Safety Catch.
Koffer Band. Polyester. Sicherheitsverschluss.
Sangle Bagage. Polyester. Fermeture Sécurité.
Koffer Riem. Polyester. Veiligheidsluiting.

200 × 6 cm 100 / 25 Print Code: E(1), V



02

08

06

New



Cyde 20362

Shoe Bag. Non-Woven.
Schuhtasche. Non-Woven.
Sac à Chaussures. T.N.T.
Schoenenzak. Non-Woven.

33 x 44 cm

300 / 10

Print Code: F(1)



11



19



03



05



Recco 4182

Shoe Bag. Non-Woven.
Schuhtasche. Non-Woven.
Sac Chaussures. T.N.T.
Schoenentas. Non-Woven.

42 x 20 x 14,5 cm

400 / 10

Print Code: F(1)



02



03

19

02

06



08

Tarok 6342

Bag. Polyester 600D.
Tasche. Polyester 600D.
Sac. Polyester 600D.
Tas. Polyester 600D.

42 x 34 x 16 cm

40

Print Code: G(1), N(8)



03



19

Kibix 4235

Garment Bag. PEVA.
Kleidertasche. PEVA.
Porte-Costumes. PEVA.
Kledinghoes. PEVA.

60 x 100 cm

100 / 25

Print Code: G(1)



02

RPET

569

URBAN TRAVEL



Holtrum 6841

Bag. Polyester 600D RPET.
Tasche. Polyester 600D RPET.
Sac. Polyester 600D RPET.
Tas. Polyester 600D RPET.

48.5 x 28 x 27.5 cm 30 Print Code: G(1), N(8)

RFID PROTECTION

Keep Your device Details Safe
With the **RFID** Protection System



Donatox 6043

Bag. Polyester 600D. USB Connection. Shoe Compartment.
Tasche. Polyester 600D. USB Anschluss. Schuh Staufach.
Sac. Polyester 600D. Connexion USB. Compartiment Porte-Chaussures.
Tas. Polyester 600D. USB Verbinding. Schoen Compartment.

50 x 30 x 28.5 cm 25 Print Code: G(1), N(8), P

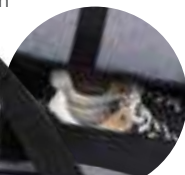

Kanit 6426

Bag. Polyester 600D. RFID Pocket Protection. Shoe Compartment.
Tasche. Polyester 600D. Tasche mit RFID Schutz. Schuh Staufach.
Sac. Polyester 600D. Poche avec Protecteur RFID. Compartiment Porte-Chaussures.
Tas. Polyester 600D. Zak met RFID Bescherming. Schoen Compartment.

50 x 38 x 24 cm 20 Print Code: G(1), N(8)

Travel Bags



New

Sharyl 20200

Bag. Canvas/ PU.
Tasche. Segeltuch/ PU.
Sac. Toile/ Similicuir.
Tas. Canvas/ PU.

70 x 36 x 24 cm 10 Print Code: H(1), N(8)



New

Denehy 20886

2in1
MULTI-FUNCTION

Backpack Bag. PU. Padded Back and Shoulder Straps. Shoe Compartment.
Rucksack Tasche. PU. Gepolsterter Rücken und Schultergurte. Schuh Staufach.
Sac à Dos. Similicuir. Dos et Bretelles Rembourrées. Compartment Porte-Chaussures.
Rugzak. PU. Gewatteerde Achterzijde en Schouderbanden. Schoen Compartment.

52 x 26 x 25 cm 10 Print Code: H(1)



19

13

Stariux 1446

Bag. Canvas/ PU.
Tasche. Segeltuch/ PU.
Sac. Toile/ Similicuir.
Tas. Canvas/ PU.

75 x 48 x 25 cm 10 Print Code: H(1), N(8)



Denver 1629

Bag. Felt RPET/ PU.
Tasche. Filz RPET/ PU.
Sac. Feutrine RPET/ Similicuir.
Tas. Vilt RPET/ PU.

53 x 30 x 26 cm 20 Print Code: H(1), N(8)

RPET



Tanen 20885

Document Bag Backpack. PU. Padded. Padded Laptop Compartment.
 Dokumententasche Rucksack. PU. Gepolstert. Gepolsterte Laptoptasche.
 Sac à Dos Porte-Documents. Similicuir. Rembourré. Pochette Rembourrée pour Portable.
 Aktentas Ruzgak. PU. Gewatteerd. Gewatteerd Laptop Compartment.

33 x 48 x 16 cm 10 Print Code: J(1)

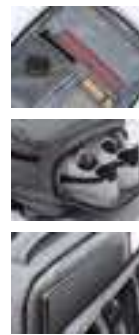

New



02

Myriax 20354

Backpack. Polyester 300D RPET. USB Connection. Padded. Padded Laptop Compartment. Shoe Compartment.
 Rucksack. Polyester 300D RPET. USB Anschluss. Gepolstert. Gepolsterte Laptoptasche. Schuh Staufach.
 Sac à Dos. Polyester 300D RPET. Connexion USB. Rembourré. Pochette Rembourrée pour Portable. Compartiment Porte-Chaussures.
 Ruzgak. Polyester 300D RPET. USB Verbinding. Gewatteerd. Gewatteerd Laptop Compartment. Schoen Compartment.

33 x 51 x 20 cm 10 Print Code: J(8)

17"

LAPTOP COMPARTMENT

08



TROLLEY LAPTOP BACKPACK



02

06



Haltrix 6047

Trolley Backpack. Polyester 300D. USB Connection. Padded Laptop Compartment. Padded Shoulder Straps.
 Trolley Rucksack. Polyester 300D. USB Anschluss. Gepolsterte Laptoptasche. Gepolsterte Schultergurte.
 Sac à Dos Trolley. Polyester 300D. Connexion USB. Pochette Rembourrée pour Portable. Bretelles Rembourrées.
 Trolley Ruzgak. Polyester 300D. USB Verbinding. Gewatteerd Laptop. Gewatteerde Schouderbanden.

33 x 47 x 22.5 cm 8 Print Code: J(8), L2



LAPTOP COMPARTMENT

Dancan 20895

Trolley Backpack. Polyester 300D. Padded Laptop Compartment. Padded Back and Shoulder Straps.
 Trolley Rucksack. Polyester 300D. Gepolsterte Laptoptasche. Gepolsteter Rücken und Schultergurte.
 Sac à Dos Trolley. Polyester 300D. Pochette Rembourrée pour Portable. Dos et Bretelles Rembourrées.
 Trolley Ruzgak. Polyester 300D. Gewatteerd Laptop. Gewatteerde Achterzijde en Schouderbanden.

33.5 x 51 x 21 cm 4 Print Code: J(8), L2

New





TSA COMBINATION LOCK



02



19



06

RPET 

03

01

02

Dacrus 6919

Trolley, RPET, Rigid, 4 Rotating Wheels, TSA Combination Lock.
 Trolley, RPET, Starre, 4 Drehende Räder, TSA Sicherheitsverschluss.
 Trolley, RPET, Rigide, 4 Roues Tournantes, Fermeture Sécurité TSA.
 Trolley, RPET, Hard, 4 Draaiende Wielen, TSA Veiligheidssluiting.

 35.5 x 53 x 23 cm  1  Print Code: J(1), L2

Kleintor 6044

Trolley, ABS, Rigid, 8 Rotating Wheels, Padded Laptop Compartment, TSA Combination Lock.
 Trolley, ABS, Starre, 8 Drehende Räder, Gepolsterte Laptoptasche, TSA Sicherheitsverschluss.
 Trolley, ABS, Rigide, 8 Roues Tournantes, Pochette Rembourrée pour Portable, Fermeture Sécurité TSA.

Trolley, ABS, Hard, 8 Draaiende Wielen, Gewatteerd Laptop Compartment, TSA Veiligheidssluiting.

 40 x 51 x 21.5 cm  1  Print Code: J(1)

Hessok 6556



Trolley, PC, Rigid, 8 Rotating Wheels, TSA Combination Lock.
 Trolley, PC, Starre, 8 Drehende Räder, TSA Sicherheitsverschluss.
 Trolley, PC, Rigide, 8 Roues Tournantes, Fermeture Sécurité TSA.
 Trolley, PC, Hard, 8 Draaiende Wielen, TSA Veiligheidssluiting.

 34 x 54 x 23 cm  1  Print Code: J(1), L2

Essentials Trolleys

TSA COMBINATION LOCK

573

URBAN TRAVEL



New



New



RPET



Chertan 20355

Trolley, Polyester 600D RPET, TSA Combination Lock.
Trolley, Polyester 600D RPET, TSA Sicherheitsverschluss.
Trolley, Polyester 600D RPET, Fermeture Sécurité TSA.
Trolley, Polyester 600D RPET, TSA Veiligheidsluiting.

33.5 x 53 x 23 cm 4 Print Code: J(8), L2



Dopkin 21129

Foldable Trolley, ABS, Rigid, 4 Rotating Wheels, Padded Laptop Compartment, TSA Combination Lock.

Faltbarer Trolley, ABS, Starre, 4 Drehende Räder, Gepolsterie Laptoptasche, TSA Sicherheitsverschluss.

Trolley Pliable, ABS, Rigide, 4 Roues Tournantes, Pochette Rembourrée pour Portable, Fermeture Sécurité TSA.

Opvouwbare Trolley, ABS, Hard, 4 Draaiende Wielen, Gewatteerd Laptop Compartment, TSA Veiligheidsluiting.

35 x 54 x 24.5 cm 1 Print Code: J(1), L2

10"
TABLET
COMPARTMENT

15"
LAPTOP
COMPARTMENT



Yacman 1628

Trolley, Polyester 300D RPET, TSA Combination Lock.
Trolley, Polyester 300D RPET, TSA Sicherheitsverschluss.
Trolley, Polyester 300D RPET, Fermeture Sécurité TSA.
Trolley, Polyester 300D RPET, TSA Veiligheidsluiting.

32.5 x 51 x 23 cm 4 Print Code: J(8)

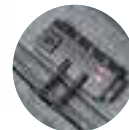

RPET



Alexluca

Italy



01

Rumax 7087

Trolley. ABS. Rigid. 4 Rotating Wheels. Combination Lock.
Trolley. ABS. Stærre. 4 Drehende Räder. Sicherheitsverschluss.
Trolley. ABS. Rigide. 4 Roues Tournantes. Fermeture Sécurité.
Trolley. ABS. Hard. 4 Draaiende Wielen. Veiligheidsluiting.

36 x 55 x 23 cm 3 Print Code: J(1), L2



02

03

11

ANTONIO MIRO



Tugart 7123

Trolley. ABS. Rigid. 4 Rotating Wheels.
Trolley. ABS. Stærre. 4 Drehende Räder.
Trolley. ABS. Rigide. 4 Roues Tournantes.
Trolley. ABS. Hard. 4 Draaiende Wielen.

36 x 60 x 22 cm 1 Print Code: J(1), L2



ANTONIO MIRO



Antonio Miró is currently a benchmark in the increasingly demanding fashion industry. Worldwide renowned and consolidated in showcases such as Paris, Milan, New York and Tokyo, with prestige earned by collections based on simplicity and perfection, being these his personal hallmarks. Minimalist like few others, Antonio Miró devotes his success to elegance, an objective he has never renounced.



Gibut 7373

2 in 1
MULTI-FUNCTION

Trolley Backpack. Polyester 300D. Padded Laptop Compartment. Padded Shoulder Straps.
Trolley Rucksack. Polyester 300D. Gepolsterte Laptoptasche. Gepolsterte Schultergurte.
Sac à Dos Trolley. Polyester 300D. Pochette Rembourrée pour Portable. Bretelles Rembourrées.
Trolley Rugzak. Polyester 300D. Gewatteerd Laptop. Gewatteerde Schouderbanden.

33 x 47 x 22,5 cm 8 Print Code: J(1), L2



11"
TABLET
COMPARTMENT



15"
LAPTOP
COMPARTMENT

575

URBAN TRAVEL



TROLLEY
STRAP

Jolens 7375

Backpack. Polyester 300D. Padded Laptop and Tablet Compartment. Padded Back and Shoulder Straps.
Rucksack. Polyester 300D. Gepolsterte Laptoptasche und Tablet. Gepolsterter Rücken und Schultergurte.
Sac à Dos. Polyester 300D. Pochette Rembourrée pour Portable et Tablette. Dos et Bretelles Rembourrées.
Rugzak. Polyester 300D. Gewatteerd Laptop en Tablet Compartment. Gewatteerde Achterzijde en Schouderbanden.

33 x 48 x 20 cm 20 Print Code: N(8)



10"
TABLET
COMPARTMENT



17"
LAPTOP
COMPARTMENT



Tronen 7374

Bag. Polyester 300D.
Tasche. Polyester 300D.
Sac. Polyester 300D.
Tas. Polyester 300D.

50 x 30 x 25 cm 30 Print Code: N(8)

14 DECO



TRENDS, COSY, COMFORT



APP
COMPATIBLE WITH
ANDROID & iOS

New

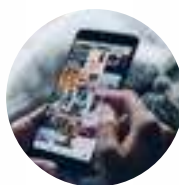

WEATHER



ALARM



TIME & DATE

Pictory 21017



TACTILE
DISPLAY



MUSIC
PLAYER



VIDEO
PLAYER



MICRO SD

Digital Photo Frame. 10,1". Wifi, 1280x800 IPS. AC 220-240V.
Digitaler Photoram. 10,1". Wifi, 1280x800 IPS. AC 220-240V.
Cadre Photos Digitales. 10,1". Wifi, 1280x800 IPS. AC 220-240V.
Digitale Fotolijst. 10,1". Wifi, 1280x800 IPS. AC 220-240V.

26.4 x 18.4 x 2.2 cm 10 Print Code: G(1)



New



New



Kyala 20608

Decorative Plant. Glas. 5 Leds. 3 Batteries AAA Not Included.
 Dekorpflanze. Glas. 5 Leds. 3 AAA Batterien Nicht im Lieferumfang.
 Plante Décorative. Verre. 5 Leds. 3 Piles AAA Non Incluses.
 Decorative Plant. Glas. 5 Leds. 3 Batterijen AAA Niet Inclusief.

Ø 8 x 14 cm 15 Print Code: E(1), L1, V



Rodina 20609

Lamp. Glas. 20 Leds. Solar Charging. Battery 300 mAh.
 Lampe. Glas. 20 Leds. Solartladung. Batterie 300 mAh.
 Lampe. Verre. 20 Leds. Charge Solaire. Batterie 300 mAh.
 Lamp. Glas. 20 Leds. Zonnelading. KabelBatterij 300 mAh.

Ø 7.8 x 13.5 cm 20 Print Code: F(1), L2



New



Joneson 20607

Lamp. Wood. 16 Leds. 2 Light Modes. Foldable. Battery 700 mAh.
 Lampe. Holz. 16 Leds. 2 Lichtpositionen. Faltbar. Batterie 700 mAh.
 Lampe. Bois. 16 Leds. 2 Modes de Lumière. Pliable. Batterie 700 mAh.
 Lamp. Hout. 16 Leds. 2 Licht Posities. Opvouwbaar. Batterij 700 mAh.

9 x 12 x 2.4 cm 50 Print Code: E(1), L2, W



Sarpal 1710

Lamp. Bamboo. Bulb 40W. Adjustable Brightness. AC 220-240V.
 Lampe. Bambou. Bulbe 40W. Einstellbare Lichtintensität. AC 220-240V.
 Lampe. Bambou. Bulbe 40W. Lumière à Intensité Réglable. AC 220-240V.
 Lamp. Bamboe. Bulb 40W. Lamp met Instelbare Lichtintensiteit. AC 220-240V.

14 x 15 x 8 cm 10 Print Code: E(4), L2





Huntan 20605

Water Fountain. 1 Led. 20 Pierre Inclusive. 3 Piles AA Non Included.
 Wasserquelle. 1 Led. 20 Steine Enthalten. 3 AA Batterien Nicht im Lieferumfang.
 Source d'eau. 1 Led. 20 Pierres Incluses. 3 Piles AA Non Inclus.
 Waterfontein. 1 Led. 20 Stenen Inbegrepen. 3 Batterijen AA Niet Inclusief.

11.3 x 15.3 x 8.5 cm 20 Print Code: E(1)



New

Sarenel 20699



Aromatic Diffuser. Glass. 10 Crystal Stones. Oil 10 ml. Lavender Aroma.
 Aromatischer Diffusor. Glas. 10 Kristallsteine. Öl 10 ml. Lavendel Aroma.
 Diffuseur Aromatique. Verre. 10 Pierres de Cristal. Huile 10 ml. Arôme Lavande.
 Luchtverfrisser. Glas. 10 Kristalstenen. Olie 10 ml. Lavendel Aroma.

Ø 8.8 x 5.1 cm 20 Print Code: E(1), L1



New

Boucher 20910



Aromatic Diffuser. Pink Himalayan Salt Stones. Oil 10 ml. Lavender Aroma. Multicolour Led Lights. 150 ml. 1 Steam Mode. USB Connection.
 Aromatischer Diffusor. Pink-Salzmühle Himalaya. Öl 10 ml. Lavendel Aroma. Led Lichten. Mehrfarbige Led Lichten. 150 ml. 1 Dampf Funktion. USB Anschluss.
 Diffuseur Aromatique. Pierres Roses de Sel de l'Himalaya. Huile 10 ml. Arôme Lavande. Lumières Led Multicolores. 150 ml. 1 Mode de Vapeur. Connexion USB.
 Luchtverfrisser. Roze Himalaya Zoutstenen. Olie 10 ml. Lavendel Aroma. Meerkleurige Led Lichten. 150 ml. 1 Stoom Positie. USB Verbinding.

Ø 9 x 9.7 cm 30 / 15 Print Code: E(1)



130 ml

Festok 6515

Humidifier. Multicolour Led Lights. 130 ml. 1 Steam Mode. USB Connection.
 Luftbefeuchter. Mehrfarbige Led Lichten. 130 ml. 1 Dampf Funktion. USB Anschluss.
 Humidificateur. Lumières Led Multicolores. 130 ml. 1 Mode de Vapeur. Connexion USB.
 Luchtbevochtiger. Meerkleurige Led Lichten. 130 ml. 1 Stoom Positie. USB Verbinding.



📏 Ø 10 x 9.5 cm 📦 50 🖨️ Print Code: E(1), L1



250 ml



Wicket 1147

Humidifier. PC/ Bamboo. Led Lights. 2 Light Modes, Fixed and Flashing. 250 ml. 1 Steam Mode. USB Connection.
 Luftbefeuchter. PC/ Bambus. Led Lichten. 2 Lichtpositionen, Festes und Blinkendes. 250 ml. 1 Dampf Funktion. USB Anschluss.
 Humidificateur. PC/ Bambou. Lumières Led. 2 Modes de Lumière, Fixe et Clignotante. 250 ml. 1 Mode de Vapeur. Connexion USB.
 Luchtbevochtiger. PC/ Bamboe. Led Lichten. 2 Licht Posities, Vast en Knipperend. 250 ml. 1 Stoom Positie. USB Verbinding.

📏 Ø 9 x 11.5 cm 📦 30 🖨️ Print Code: E(1), L1



200 ml



Krougax 1872

Humidifier. PP/ Cork. 200 ml. 2 Steam Modes. USB Connection.
 Luftbefeuchter. PP/ Kork. 200 ml. 2 Dampf Funktionen. USB Anschluss.
 Humidificateur. PP/ Liège. 200 ml. 2 Modes de Vapeur. Connexion USB.
 Luchtbevochtiger. PP/ Kurk. 200 ml. 2 Stoom Posities. USB Verbinding.

📏 Ø 7 x 17.3 cm 📦 30 🖨️ Print Code: E(4), L1



New

240 ml



Aurion 20576

Humidifier. Multicolour Led Lights. 240 ml. 2 Steam Modes. USB Connection. Fan Included.

Luftbefeuchter. Mehrfarbige Led Lichten. 240 ml. 2 Dampf Funktionen. USB Anschluss. Ventilator Inklusiv.

Humidificateur. Lumières Led Multicolores. 240 ml. 2 Modes de Vapeur. Connexion USB. Ventilateur Inclusif.

Luchtbevochtiger. Meerkleurige Led Lichten. 240 ml. 2 Stoom Posities. USB Verbinding. Ventilator Inklusief.

📏 6.5 x 16.2 x 6.5 cm 📦 40 🖨️ Print Code: E(4)



200 ml



Trudy 6127

Humidifier. Multicolour Led Lights. 200 ml. 2 Steam Modes. USB Connection.
 Luftbefeuchter. Mehrfarbige Led Lichten. 200 ml. 2 Dampf Funktionen. USB Anschluss.
 Humidificateur. Lumières Led Multicolores. 200 ml. 2 Modes de Vapeur. Connexion USB.
 Luchtbevochtiger. Meerkleurige Led Lichten. 200 ml. 2 Stoom Posities. USB Verbinding.

📏 Ø 6 x 14.9 cm 📦 50 🖨️ Print Code: E(1)



AROMATIC

02
SANDALWOOD01
JASMINE**Kenet 1689**

Aromatic Diffuser. Glass. 100 ml.
Aromatischer Diffusor. Glas. 100 ml.
Diffuseur Aromatique. Verre. 100 ml.
Luchtverfrisser. Glas. 100 ml.

100 ml
Ø 6.9 x 18.2 cm 20 Print Code: E(1), L1

100 ml



15 ml

JASMINE

Nailex 4840

Aromatic Diffuser. Jasmine Aroma. 15 ml.
Duft Diffusor. Jasmin Aroma. 15 ml.
Diffuseur Aromatique. Arôme Jasmin. 15 ml.
Luchtverfrisser. Jasmijn Aroma. 15 ml.

9 x 15.7 x 4.2 cm 100/50 Print Code: E(1)



JASMINE

50 ml

VANILLA

Hanks 1690

Aromatic Set. Aromatic Diffuser Glass Jasmine Aroma 50 ml. Candle Glass Vanilla Aroma.
Aromatischer Set. Aromatischer Diffusor Glas Jasmin Aroma 50 ml. Kerze Glas Vanille Aroma.
Set Aromatique. Diffuseur Aromatique Verre Arôme Jasmin 50 ml. Bougie Verre Arôme Vanille.
Aromatische Set. Luchtverfrisser Glas Jasmijn Aroma 50 ml. Kaars Glas Vanille Aroma.

18 x 8.5 x 5.5 cm 30 Print Code: E(1)



New

04



03



VANILLA



Elora 20600

Aromatic Candle. Ceramic. Vanilla Aroma.
 Duftkerze. Keramik. Vanille Aroma.
 Bougie Aromatique. Céramique. Arôme Vanille.
 Geurkaars. Keramiek. Vanille Aroma.

📏 Ø 7 x 7.8 cm 📖 20 🖨️ Print Code: E(1)



08



13

Lonka 1688

Aromatic Candle. Glass/ Bamboo. Cinnamon.
 Duftkerze. Glas/ Bambus.
 Bougie Aromatique. Verre/ Bambou.
 Geurkaars. Glas/ Bamboe.

📏 Ø 7 x 8.5 cm 📖 40 🖨️ Print Code: E(1), L1



04



02



01



Trivak 6792

Aromatic Candle. Glass/ Bamboo. Vanilla Aroma.
 Duftkerze. Glas/ Bambus. Vanille Aroma.
 Bougie Aromatique. Verre/ Bambou. Arôme Vanille.
 Geurkaars. Glas/ Bamboe. Vanille Aroma.

📏 Ø 7 x 8.7 cm 📖 50 🖨️ Print Code: E(1), L1



New



PLANT BASED WAX

Lavolia 20604

Aromatic Candle. Ceramic/ Cork/ Bamboo. Plant Based Wax. Linen Aroma.
 Duftkerze. Keramik/ Kork/ Bambus. Wachs auf Pflanzenbasis. Leinen Aroma.
 Bougie Aromatique. Céramique/ Liège/ Bambou. Cire Végétale. Lin Vanille.
 Geurkaars. Keramiek/ Kurk/ Bamboe. Plantaardige Was. Linnen Aroma.

📏 Ø 7 x 6.6 cm 📖 50 🖨️ Print Code: E(1), L1



New



Safron 20603

Aromatic Candle. Glass/ Bamboo. Vanilla Aroma.
 Duftkerze. Glas/ Bambus. Vanille Aroma.
 Bougie Aromatique. Verre/ Bambou. Arôme Vanille.
 Geurkaars. Glas/ Bamboe. Vanille Aroma.

📏 6 x 6.5 x 6 cm 📖 50 🖨️ Print Code: E(1), L1



Made in Europe



Bayar 2703

Aromatic Candle. Glass/ Wood. Vanilla Aroma.
 Duftkerze. Glas/ Holz. Vanille Aroma.
 Bougie Aromatique. Verre/ Bois. Arôme Vanille.
 Geurkaars. Glas/ Hout. Vanille Aroma.

📏 Ø 6.5 x 8.2 cm 📖 24 🖨️ Print Code: E(1), L1





Hetfil 20601

Aromatic Candle. Metal. Vanilla Aroma.
 Duftkerze. Metall. Vanille Aroma.
 Bougie Aromatique. Métal. Arôme Vanille.
 Geurkaars. Metaal. Vanille Aroma.

5.5 x 4.3 x 5.5 cm 100 / 50
 Print Code: E(1), L1



Rudyn 20602

Aromatic Candle. Aluminium/ Bamboo. Vanilla Aroma.
 Duftkerze. Aluminium/ Bambus. Vanille Aroma.
 Bougie Aromatique. Aluminium/ Bambou. Arôme Vanille.
 Geurkaars. Aluminium/ Bamboe. Vanille Aroma.

Ø 6.5 x 7.5 cm 40
 Print Code: E(1), L1



Sioko 4819

Aromatic Candle. Metal. Vanilla Aroma.
 Duftkerze. Metall. Vanille Aroma.
 Bougie Aromatique. Métal. Arôme Vanille.
 Geurkaars. Metaal. Vanille Aroma.

Ø 6.3 x 3 cm 100 / 50
 Print Code: E(1), L1



PLANT BASED WAX

Suyen 1773

Aromatic Candle. Aluminium/ Cork. Plant Based Wax. Vanilla Aroma.
 Duftkerze. Aluminium/ Kork. Wachs auf Pflanzenbasis. Vanille Aroma.
 Bougie Aromatique. Aluminium/ Liège. Cire Végétale. Arôme Vanille.
 Geurkaars. Aluminium/ Kurk. Plantaardige Was. Vanille Aroma.

Ø 8.5 x 4.7 cm 100 / 50
 Print Code: E(1), L1



Shiva 9718

Aromatic Candle. Metal.
 Duftkerze. Metall.
 Bougie Aromatique. Métal.
 Geurkaars. Metaal.

Ø 6.4 x 5 cm 100 / 50
 Print Code: E(1), L1





01



19



Tepor 6348

Aromatic Candle. Glass/ Cork.
Duftkerze. Glas/ Kork.
Bougie Aromatique. Verre/ Liège.
Geurkaars. Glas/ Kurk.

📏 Ø 5,6 x 7,6 cm 📦 100 / 25
🏷️ Print Code: E(1), L1



Yiren 1498

Aromatic Candle. Wood. Vanilla Aroma.
Duftkerze. Holz. Vanille Aroma.
Bougie Aromatique. Bois. Arôme Vanille.
Geurkaars. Hout. Vanille Aroma.

📏 Ø 5,9 x 4 cm 📦 100 / 50
🏷️ Print Code: E(1), L1



01



03



16



19

Saicer 2702

Aromatic Candle. Glass.
Duftkerze. Glas.
Bougie Aromatique. Verre.
Geurkaars. Glas.

📏 Ø 6 x 7 cm 📦 24 🌍 Made in Europe
🏷️ Print Code: E(1), L1



Temul 6408

Aromatic Candle. Glass. Vanilla Aroma. Chalk Included.
Duftkerze. Glas. Vanille Aroma. Kreide Inklusive.
Bougie Aromatique. Verre. Arôme Vanille. Craie Incluse.
Geurkaars. Glas. Vanille Aroma. Krijtje Inclusief.

📏 Ø 7 x 7,8 cm 📦 50 🏷️ Print Code: E(1), L1



PLANT BASED WAX



Kesha 1687



Aromatic Candle Set. Glass. 2 Pieces. Plant Based Wax. Freesia Aroma.
Duftkerzen Set. Glas. 2 Stück. Wachs auf Pflanzenbasis. Freesia Aroma.
Set Bougies Aromatiques. Verre. 2 Pièces. Cire Végétale. Arôme Freesia.
Geurkaarsen Set. Glas. 2 Stuks. Plantaardige Was. Vanille Freesia.

📏 11,5 x 5,5 x 6 cm 📦 40 / 20 🏷️ Print Code: E(1), L1

LIMITED
edition
EXPERIENCE



Windu 1357



Aromatic Candle. Bamboo. Vanilla Aroma.
Duftkerze. Bambus. Vanille Aroma.
Bougie Aromatique. Bambou. Arôme Vanille.
Geurkaars. Bamboe. Vanille Aroma.

📏 10 x 8 x 10 cm 📦 30 🏷️ Print Code: F(1), L2

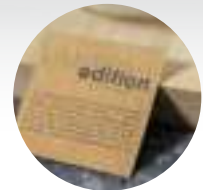



Lisa 20142



PINE SEEDS

Aromatic Candle. Glass. Pine Aroma. Pine Seeds Included.
 Duftkerze. Glas. Pinien Aroma. Piniensamen Inklusive.
 Bougie Aromatique. Verre. Arôme Pin. Graines de Pin Incluses.
 Geurkaars. Glas. Pijnboom Aroma. Pijnboom Zaden Inclusief.

📏 Ø 4.3 x 4.9 cm 📦 100 🗣️ Print Code: E(1), L1



Graox 20241

Desk Clock. Bamboo. Water Powered.
 Tischuhr. Bambus. Funktioniert mit Wasser.
 Horloge. Bambou. Fonctionne à l'Eau.
 Klok. Bamboe. Water Energie.

📏 9.5 x 8 x 9 cm 📦 40 🗣️ Print Code: E(4), L1



Eciko 20240

Desk Clock. Bamboo/ Stainless Steel. 1 Battery AA Not Included.
 Tischuhr. Bambus/ Rostfreier Stahl. 1 AA Batterie Nicht im Lieferumfang.
 Horloge. Bambou/ Acier Inox. 1 Pile AA Non Incluse.
 Klok. Bamboe/ Roestvrij Staal. 1 Batterij AA Niet Inclusief.

📏 8.5 x 10.1 x 5.3 cm 📦 50 🗣️ Print Code: E(4), L1

Faran 20120

Sand Timer. Borosilicate Glass/ Wood. 5 Minutes.
 Sanduhr. Borosilikat Glas/ Holz. 5 Minuten.
 Sablier. Verre Borosilicate/ Bois. 5 Minutes.
 Zandloper. Borosilicate Glas/ Hout. 5 Minuten.

📏 6.5 x 14 x 6.5 cm 📦 50 🗣️ Print Code: E(4), L1



Trinket 20121

Sand Timer. Borosilicate Glass/ Wood. 3 Minutes.
 Sanduhr. Borosilikat Glas/ Holz. 3 Minuten.
 Sablier. Verre Borosilicate/ Bois. 3 Minutes.
 Zandloper. Borosilicate Glas/ Hout. 3 Minuten.

📏 Ø 4.2 x 8.1 cm 📦 200 / 100 🗣️ Print Code: D(4), L1



Azumy 1697

Mini Zen Garden. Wood. 5 Accessories.
 Mini Zen Garten. Holz. 5 Teile.
 Mini Jardin Zen. Bois. 5 Accessoires.
 Mini Zen Tuin. Hout. 5 Accessoires.

📏 25 x 23 x 18 cm 📦 20 🗣️ Print Code: E(1), L1





Cinemax 5981

Light Box. Led Lights. 82 Pieces. 4 Batteries AAA Not Included.
 Leuchtkasten. Led Lichter. 82 Stück. 4 AAA Batterien Nicht im Lieferumfang.
 Ecran Lumineux. Lumières Led. 82 Pièces. 4 Piles AAA Non Incluses.
 Lightbox. Led Lichten. 82 Stuks. 4 Batterijen AAA Niet Inclusief.

15 x 10.7 x 4.1 cm 50 / 25 Print Code: D(1)

A A B B C C D D E
 E E F F G G H H I I
 J J K K L L M M N
 O O P P Q Q R R S
 T T U U V V W W X
 X X Y Y Z Z 1 1 2 2
 3 3 4 4 5 5 6 6 7 7
 8 8 9 9 0 0 * * * *
 & &



Munds 6579

Globe. Cork/ Metal. 12 Markers Included.
 Erdkugel. Kork/ Metall. 12 Marker inklusive.
 Globe Terrestre. Liège/ Métal. 12 Marqueurs Incluses.
 Wereldbol Globe. Kurk/ Staal. 12 Stiften inclusief.

Ø 15 x 20 cm 10 Print Code: G(1), L1



SCRAPER
 INCLUDED

Palsy 6590

Map. Laminated Recycled Paper. Scraper Included.
 Karte. Laminiertes Recycling Papier. Schaber inklusive.
 Mappemonde. Papier Recyclé Laminé. Grattoir inclus.
 Map. Gelamineerd Gerecycled Papier. Krabber inclusief.

43 x 28.5 cm 50 Print Code: D(1), E(1)





New



100 PHOTOS

360°

Vesper 20606

Photo Frame. MDF. Photos Size: 13,5 x 9 cm.
 Bilderrahmen. MDF. Photos: 13,5 x 9 cm.
 Porte Photos. MDF. Photos: 13,5 x 9 cm.
 Fotolijst. MDF. Foto's Maat: 13,5 x 9 cm.

15 x 22 x 15 cm 8 Print Code: F(1), L2



Tapex 6957

Photo Frame. Cork. Photos Size: 10 x 15 cm.
 Bilderrahmen. Kork. Photos: 10 x 15 cm.
 Porte Photos. Liège. Photos: 10 x 15 cm.
 Fotolijst. Kurk. Foto's Maat: 10 x 15 cm.

14 x 19 x 0,9 cm 40 Print Code: E(1), L1



Liban 6956

Photo Frame. MDF. Photos Size: 10 x 15 cm.
 Bilderrahmen. MDF. Photos: 10 x 15 cm.
 Porte Photos. MDF. Photos: 10 x 15 cm.
 Fotolijst. MDF. Foto's Maat: 10 x 15 cm.

14 x 19 x 0,9 cm 40 Print Code: L1



02

Stan 3195

Photo Frame. MDF. Photos Size: 10 x 15 cm.
 Bilderrahmen. MDF. Photos: 10 x 15 cm.
 Porte Photos. MDF. Photos: 10 x 15 cm.
 Fotolijst. MDF. Foto's Maat: 10 x 15 cm.

14 x 19 x 0,9 cm 40 Print Code: L1



19

03

01

15 HOME ESSENTIALS





**PRACTICAL
DAILY USE,
SUSTAINABLE**

KITCHEN CUTTING BOARD

Bamboo



Varadek 1127

Kitchen Cutting Board. Bamboo.
Brett. Bambus.
Planche à Découper. Bambou.
Keuken Snijplank. Bamboe.

 20 x 30 x 1 cm  30  Print Code: E(1), L2

Saraby 6802

Kitchen Cutting Board. Bamboo.
Brett. Bambus.
Planche à Découper. Bambou.
Keuken Snijplank. Bamboe.

 13.5 x 40 x 1 cm  30  Print Code: E(1), L2

Ruban 5178

Kitchen Cutting Board. Bamboo.
Brett. Bambus.
Planche à Découper. Bambou.
Keuken Snijplank. Bamboe.

 15.3 x 20 x 1 cm  50  Print Code: E(1), L2

New



Seslat 21104

Kitchen Cutting Board. Bamboo. Knife Stainless Steel/ Bamboo Included.
Brett. Bambus. Messer Rostfreier Stahl/ Bambus Inklusiv.
Planche à Découper. Bamboo. Couteau Acier Inox/ Bamboo Incluse.
Keuken Snijplank. Bamboe. Mes Roestvrij Staal/ Bamboe Inclusief.

15 x 25 x 1.3 cm 30 Print Code: E(1), L2

New

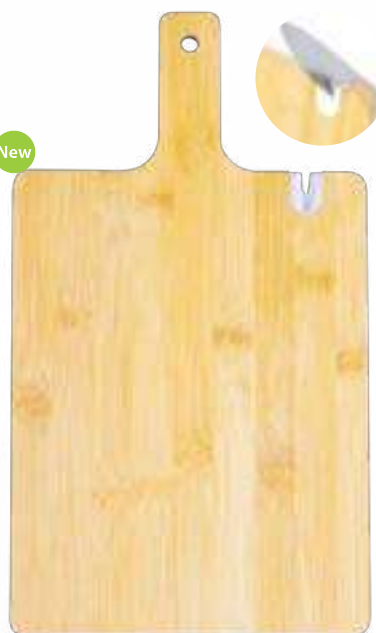

Zoria 20591

Sharpener Kitchen Cutting Board. Bamboo.
Schneidebrett. Bambus.
Planche à Découper Aiguiseur. Bamboo.
Slijper Keuken Snijplank. Bamboe.

20 x 35 x 1.5 cm 20 Print Code: E(1), L2

New



Polter 20590

Sharpener Kitchen Cutting Board. Bamboo.
Schneidebrett. Bambus.
Planche à Découper Aiguiseur. Bamboo.
Slijper Keuken Snijplank. Bamboe.

15 x 20 x 1.5 cm 20 Print Code: E(1), L2

New



Sendak 20596

Kitchen Cutting Board Set. Bamboo. 4 Pieces.
Brett Set. Bambus. 4 Stück.
Set Planche à Découper. Bamboo. 4 Pièces.
Keuken Snijplank Set. Bamboe. 4 Stuks.

29 x 23 x 7.1 cm 6 Print Code: E(1), L2

New



Mentina 20589

Weighing Scales Kitchen Cutting Board. Bamboo. 2 Batteries AAA Not Included.
Waage Brett. Bambus. 2 AAA Batterien Nicht im Lieferumfang.
Planche à Découper Balance. Bamboo. 2 Piles AAA Non Incluses.
Weegschaal Keuken Snijplank. Bamboe. 2 Batterijen AAA Niet Inclusief.

16.5 x 23.5 x 1.9 cm 10 Print Code: E(1), L2, W



Myoria 20574

Kitchen Cutting Board. Bamboo. Knife Stainless Steel/ Bamboo Included.
 Brett. Bambus. Messer Rostfreier Stahl/ Bambus Inklusive.
 Planche à Découper. Bamboo. Couteau Acier Inox/ Bamboo Incluse.
 Keuken Snijplank. Bamboe. Mes Roestvrij Staal/ Bamboe Inclusief.

23.5 x 35.5 x 1 cm 10 Print Code: E(1), L2



Nashary 1128

Kitchen Cutting Board. Bamboo.
 Brett. Bambus.
 Planche à Découper. Bamboo.
 Keuken Snijplank. Bamboe.

31.5 x 43.5 x 0.9 cm 20 Print Code: E(1), L2



Sisim 6951

Kitchen Cutting Board. Bamboo/ Slate.
 Brett. Bambus/ Schiefer.
 Planche à Découper. Bamboo/ Ardoise.
 Keuken Snijplank. Bamboe/ Leisteen.

13 x 28.5 x 1 cm 20 Print Code: E(1), L2



Condax 1241

Board. Bamboo.
 Brett. Bambus.
 Planche à Découper. Bamboo.
 Keuken Snijplank. Bamboe.

11 x 19 x 0.8 cm 100 / 50 Print Code: D(4), L1



ACACIA Wood

Janet 1696

Kitchen Cutting Board. Wood.
Brett. Holz.
Planche à Découper. Bois.
Keuken Snijplank. Hout.

 11.7 x 38 x 1 cm  50  Print Code: E(1), L2



Maidal 1695

Kitchen Cutting Board. Wood.
Brett. Holz.
Planche à Découper. Bois.
Keuken Snijplank. Hout.

 15.3 x 20 x 1 cm  50  Print Code: E(1), L2



Wood



Cyntiax 2680

 Made in Europe

Kitchen Cutting Board. Wood.
Brett. Holz.
Planche à Découper. Bois.
Keuken Snijplank. Hout.

 17 x 21.5 x 0.6 cm  40  Print Code: E(1), L2





Dooku 1340

Kitchen Cutting Board. Bamboo/ Marble Extract.
Brett. Bambus/ Marmor Extrakten.
Planche à Découper. Bambou/ Extrait Marbre.
Keuken Snijplank. Bamboe/ Marmer-Extraceten.

19 x 29 x 1 cm 10 Print Code: F(1), L2



Lonsen 1339

Kitchen Cutting Board. Bamboo/ Marble Extract.
Brett. Bambus/ Marmor Extrakten.
Planche à Découper. Bambou/ Extrait Marbre.
Keuken Snijplank. Bamboe/ Marmer-Extraceten.

18 x 38 x 1 cm 10 Print Code: F(1), L2



Bergin 20593

Knife Set. Stainless Steel/ Wood. 4 Pieces.
Messer Set. Rostfreier Stahl/ Holz. 4 Stück.
Set Couteaux. Acier Inox/ Bois. 4 Pièces.
Messen Set. Roestvrij Staal/ Hout. 4 Stuks.

35.5 x 3.3 x 19.5 cm 8
Print Code: F(1), L2



Wheeler 1693

Knife Block. Stainless Steel/ Wood. 5 Pieces.
Messerblock. Rostfreier Stahl/ Holz. 5 Stück.
Set Couteaux. Acier Inox/ Bois. 5 Pièces.
Messenblok. Roestvrij Staal/ Hout. 5 Stuks.

7.9 x 34 x 7.9 cm 10 Print Code: F(1), L2



Cheese Set



595

HOME ESSENTIALS

Helvet 20579

Fondue. Ceramic/ Metal. 2 Services.
Fondue. Keramik/ Metall. 2 Personen.
Fondue. Céramique/ Métal. 2 Services.
Fondue. Keramiek/ Metaal. 2 Service.

 Ø 9.5 x 13 cm  10  Print Code: F(1)



Hiblux 6994

Wine and Cheese Knife Set. Bamboo. 4 Accessories.
Wein und Käse Set. Bambus. 4 Teile.
Set Vin et Fromages. Bambou. 4 Accessoires.
Wijn en Kaas Set. Bamboe. 4 Accessoires.

 25 x 3.6 x 19 cm  10  Print Code: F(1), L2



Pomel 6950

Cheese Knife Set. Bamboo/ Stainless Steel. 5 Pieces. Slate Kitchen Cutting Board Included.
Käse Set. Bambus/ Rostfreier Stahl. 5 Stück. Schiefer Brett Inklusive.
Set Fromages. Bambou/ Acier Inox. 5 Pièces. Planche à Découper Ardoise Incluse.
Kaas Set. Bamboe/ Roestvrij Staal. 5 Stuks. Leisteen Keuken Snijplank Inclusief.

 Ø 24 x 4 cm  8  Print Code: F(1), L2



Cheese Set



Sondrex 21098

Wine and Cheese Knife Set. Bamboo/ Stainless Steel. 4 Accessories.
 Wein und Käse Set. Bambus/ Rostfreier Stahl. 4 Teile.
 Set Vin et Fromages. Bambou/ Acier Inox. 4 Accessoires.
 Wijn en Kaas Set. Bamboe/ Roestvrij Staal. 4 Accessoires.

15.5 x 2.7 x 22.7 cm 30 Print Code: F(1), L2



Kubin 20595

Cheese Knife Set. Wood/ Stainless Steel. 4 Pieces.
 Käse Set. Holz/ Rostfreier Stahl. 4 Stück.
 Set Fromages. Bois/ Acier Inox. 4 Pièces.
 Kaas Set. Hout/ Roestvrij Staal. 4 Stuks.

17 x 2.2 x 19.6 cm 30 Print Code: F(1), L2



Tauroa 1473

Cheese Knife Set. Bamboo/ Stainless Steel. 3 Pieces.
 Käse Set. Bambus/ Rostfreier Stahl. 3 Stück.
 Set Fromages. Bambou/ Acier Inox. 3 Pièces.
 Kaas Set. Bamboe/ Roestvrij Staal. 3 Stuks.

26 x 2.6 x 25 cm 20 / 10 Print Code: F(1), L2



Nestor 1474

Cheese Knife Set. Bamboo/ Stainless Steel. 2 Pieces.
 Käse Set. Bambus/ Rostfreier Stahl. 2 Stück.
 Set Fromages. Bambou/ Acier Inox. 2 Pièces.
 Kaas Set. Bamboe/ Roestvrij Staal. 2 Stuks.

21.8 x 2.1 x 21.4 cm 20 / 10 Print Code: F(1), L2





Mildred 1713

Cheese Knife Set, Bamboo/ Stainless Steel, Magnetic, 4 Pieces.
 Käse Set, Bambus/ Rostfreier Stahl, Magnetisch, 4 Stück.
 Set Fromages, Bambou/ Acier Inox, Magnétique, 4 Pièces.
 Kaas Set, Bamboe/ Roestvrij Staal, Magnetisch, 4 Stuks.

30 x 4 x 21.4 cm 10 / 5 Print Code: F(1), L2

Wayne 1712

Cheese Knife Set, Bamboo/ Stainless Steel, 4 Pieces.
 Käse Set, Bambus/ Rostfreier Stahl, 4 Stück.
 Set Fromages, Bambou/ Acier Inox, 4 Pièces.
 Kaas Set, Bamboe/ Roestvrij Staal, 4 Stuks.

20.5 x 3 x 19 cm 10 Print Code: F(1), L2



Blanch 20127

Nutcracker, Wood.
 Nussknacker, Holz.
 Casse-Noisette, Bois.
 Notenkraker, Hout.

Ø 6 x 9.7 cm 100 / 50 Print Code: D(1), L1



Batsly 20126



Nutcracker, Metal, Bamboo Bowl Included.
 Nussknacker, Metall, Bambus Schüssel Inklusief.
 Casse-Noisette, Métal, Bol Bambou Inclusive.
 Notenkraker, Metaal, Bamboe Voerbak Inclusief.

16.2 x 10.1 x 16.2 cm 20 Print Code: F(1), L2



Selma 5181



Spoon. Bamboo.
Löffel. Bambus.
Cuillère. Bambou.
Lepel. Bamboe.

 6 x 30 x 0.9 cm  200 / 50
 Print Code: C(4), L1

Selma 5181

Serly 6498



Spatula. Bamboo.
Spatel. Bambus.
Spatule. Bambou.
Spatel. Bamboe.

 6 x 30 x 0.9 cm  200 / 50
 Print Code: C(4), L1

Serly 6498

**Berter 1694**

Salad Set. Bamboo. 2 Pieces. Cotton Pouch.
Salat set. Bambus. 2 Stück. Baumwolle Etui.
Set Salade. Bambou. 2 Pièces. Étui Coton.
Salade Set. Bamboe. 2 Stuks. Katoen Zakje.

 9 x 32 x 2 cm  100 / 50  Print Code: B(4), F(1), L1, N(6)

Zaidax 1698

Kitchen Set. Ceramic/ Wood/ Silicone. 3 Pieces.
Küchen Set. Keramik/ Holz/ Silikon. 3 Stück.
Set Cuisine. Céramique/ Bois/ Silicone. 3 Pièces.
Keuken Set. Keramiek/ Hout/ Siliconen. 3 Stuks.

 9 x 36 x 9 cm  20  Print Code: F(1), L1

ACACIA
Wood

Bamboo





Benuat 20583

Grater: Stainless Steel/ PP.
Reibe: Rostfreier Stahl/ PP.
Råpe: Acier Inox/ PP.
Rasp. Roestvrij Staal/ PP.

5.5 x 24.5 x 2 cm

200 / 100

Print Code: D(4), L1



BAMBOO

Nigma 20572

Kitchen Tongs. Bamboo.
Zange. Bambus.
Pince. Bambou.
Bestek. Bamboe.

5 x 30 x 1.3 cm

200 / 50

Print Code: C(1), L1



BAMBOO

Aloria 20582

Spatula. Silicone/ Bamboo.
Spatel. Silikon/ Bambus.
Spatule. Silicone/ Bambou.
Spatel. Siliconen/ Bamboe.

3.5 x 21 x 0.8 cm

500 / 50

Print Code: D(4), L1



BAMBOO

Reng 20585

Chopstick Set. Bamboo. 50 Pieces.
Stäbchen-Set. Bambus. 50 Stück.
Set de Baguettes. Bambou. 50 Pièces.
Stokjes Set. Bamboe. 50 Stuks.

Ø 6.2 x 12.4 cm

50

Print Code: F(1), L1



Wood

Natural



Lenon 2669

Rolling Pin. Wood.
Rolle. Holz.
Rouleau à Pâtisserie. Bois.
Deegroller. Hout.

 Made in Europe

 Ø 5 x 40 cm  40 / 5  Print Code: B(4), L1



Meyte 2667

Hibray 2665

Hever 2666

Offen 2668

Meyte 2667

Spoon. Wood.
Löffel. Holz.
Cuillère. Bois.
Lepel. Hout.

 Made in Europe

 5 x 22 x 1 cm  480 / 20  Print Code: A(4), L1

Hibray 2665

Spoon. Wood.
Löffel. Holz.
Cuillère. Bois.
Lepel. Hout.



 Made in Europe

 6 x 30 x 1 cm  300 / 20  Print Code: A(4), L1

Hever 2666

Spatula. Wood.
Spatel. Holz.
Spatule. Bois.
Spatel. Hout.



 Made in Europe

 5 x 30 x 0.6 cm  400 / 20
 Print Code: A(4), L1

Offen 2668

Fork. Wood.
Gabel. Holz.
Fourchette. Bois.
Vork. Hout.

 Made in Europe

 3 x 22 x 1 cm  600 / 20
 Print Code: A(4), L1



Hinflex 6514

Weighing Scales. Bamboo. Button Battery Included.
 Waage. Bambus. Knopfzelle Inklusive.
 Balance. Bambou. Pile Bouton Incluse.
 Weegschaal. Bamboe. Knopcel Batterij Inclusief.

📏 Ø 19.3 x 1.7 cm 📦 20 🖨️ Print Code: E(1), L2, W



Yonan 1113

Salt and Pepper Mill. Wood. Adjustable Grinder.
 Salz- und Pfeffermühle. Holz. Einstellbare Schleifer.
 Moulin à Sel et Poivre. Bois. Meuleuse Réglable.
 Zout- en Pepermolen. Hout. Stijper Instelbare.

📏 Ø 5.6 x 15.1 cm 📦 50 🖨️ Print Code: E(1), L1



Titox 1272

Pizza Cutter. Bamboo/ Stainless Steel.
 Pizzamesser. Bambus/ Rostfreier Stahl.
 Coupe-Pizzas. Bambou/ Acier Inox.
 Pizza Snijder. Bamboe/ Roestvrij Staal.

📏 7.5 x 8.5 x 1.1 cm 📦 200 / 50 🖨️ Print Code: D(4), L1



70 ml

230 ml

Tumber 1242

Spice Set. Borosilicate Glass/ Bamboo/ Cork. 4 Pieces. 70 ml.
 Gewürz-Set. Borosilikat Glas/ Bambus/ Kork. 4 Stück. 70 ml.
 Set d'Épices. Verre Borosilicate/ Bambou/ Liège. 4 Pièces. 70 ml.
 Kruidenset. Borosilicate Glas/ Bamboe/ Kurk. 4 Stuks. 70 ml.

📏 17.3 x 14 x 5.2 cm 📦 20 🖨️ Print Code: E(1), L1



Gaby 1373

Jar Set. Glass/ Bamboo. 3 Pieces. 230 ml.
 Krug-Set. Glas/ Bambus. 3 Stück. 230 ml.
 Set Pots. Verre/ Bambou. 3 Pièces. 230 ml.
 Pot Set. Glas/ Bamboe. 3 Stuks. 230 ml.

📏 26 x 8.4 x 10.5 cm 📦 10 🖨️ Print Code: E(1), L2





Seloria 20587

Bread Basket. Jute/ Cotton.
Brotkorb. Jutestoff/ Baumwolle.
Corbelle. Jute/ Coton.
Broodmand. Jute/ Katoen.

📏 Ø 15 x 20 cm 📦 300 / 100 🖨️ Print Code: F(1), N(8)



Zolar 20588

Bread Basket. Cork/ Cotton.
Brotkorb. Kork/ Baumwolle.
Corbelle. Liège/ Coton.
Broodmand. Kurk/ Katoen.

📏 Ø 15 x 15.5 cm 📦 300 / 100 🖨️ Print Code: F(1), N(8)

ACACIA Wood



Branduk 1700

Serving Dishes. Ceramic/ Wood. 3 Pieces.
Vorspeisen Schale. Keramik/ Holz. 3 Stück.
Plateau Apéritif. Céramique/ Bois. 3 Pièces.
Schaaltjes. Keramiek/ Hout. 3 Stuks.

📏 27.5 x 6.4 x 7.9 cm 📦 15
🖨️ Print Code: E(1), F(4), L1



Bekox 1699

Kitchen Set. Ceramic/ Wood. 2 Pieces.
Küchen Set. Keramik/ Holz. 2 Stück.
Set Cuisine. Céramique/ Bois. 2 Pièces.
Keuken Set. Keramiek/ Hout. 2 Stuks.

📏 12 x 8 x 8.5 cm 📦 30 🖨️ Print Code: E(1), F(4), L1



Nesty 5180

Chopsticks Set. Bamboo. 2 Pieces.
 Stäbchen Set. Bambus. 2 Stück.
 Set Baguettes. Bambou. 2 Pièces.
 Eetstokjes Set. Bamboe. 2 Stuks.

22.5 cm 500 / 50 Print Code: B(4), L1



Jakarta 9316

Place Mat. Bamboo.
 Matte. Bambus.
 Set Table. Bambou.
 Placemat. Bamboe.

45 x 30 x 0.3 cm 100 / 20 Print Code: E(1)



Gunkan 1401

Sushi Set. Bamboo/ Slate. 6 Pieces.
 Sushi Set. Bambus/ Schiefer. 6 Stück.
 Set Sushi. Bambou/ Ardoise. 6 Pièces.
 Sushi Set. Bamboe/ Leisten. 6 Stuks.

28 x 2.3 x 9 cm 20 Print Code: E(1), L2



Yantic 6487

Coaster Set. Wood. 4 Pieces.
 Untersetzer Set. Holz. 4 Stück.
 Set Sous-Verre. Bois. 4 Pièces.
 Onderzetter Set. Hout. 4 Stuks.

Ø 10 x 4 cm 50 / 25 Print Code: D(1), L1



UNIQUE PIECES FROM NATURAL CUTS OF WOOD.
 THE TEXTURE, COLOR, SIZES AND THICKNESS MAY VARY.



Kappal 6801

Coaster Set. Bamboo. 4 Pieces.
 Untersetzer Set. Bambus. 4 Stück.
 Set Sous-Verre. Bambou. 4 Pièces.
 Onderzetter Set. Bamboe. 4 Stuks.

11,2 x 3,6 x 11,2 cm 50 Print Code: E(1), L2



Sanly 1708

Coaster Set. Bamboo/ Felt RPET. 10 Pieces.
 Untersetzer Set. Bambus/ Filz RPET. 10 Stück.
 Set Sous-Verre. Bambou/ Feutrine RPET. 10 Pièces.
 Onderzetter Set. Bamboe/ Vilt RPET. 10 Stuks.

10,7 x 6 x 10,7 cm 50 Print Code: D(1), E(1), L2, N(8)



RPET



Yagger 1655

Coaster Set. Cork. 4 Pieces. Cotton Pouch.
 Untersetzer Set. Kork. 4 Stück. Baumwolle Etui.
 Set Sous-Verre. Liège. 4 Pièces. Étui Coton.
 Onderzetter Set. Kurk. 4 Stuks. Katoen Zakje.

13 x 15 x 1,7 cm 200 / 50 Print Code: D(1), F(1), L1, N(8)



New

Melorix 20575

Holder. Cork.
Halter. Kork.
Support. Liège.
Houder. Kurk.

📏 Ø 15 x 1 cm 📦 100 / 50 🏷️ Print Code: E(1), L2, N(8), W

Mizar 20580

Coaster Set. Bamboo. 4 Pieces.
Untersetzer Set. Bambus. 4 Stück.
Set Sous-Verre. Bambou. 4 Pièces.
Onderzetter Set. Bamboe. 4 Stuks.

📏 21 x 0.5 x 21 cm 📦 50 🏷️ Print Code: E(1), L2



Seitol 6992

Coaster Set. Bamboo/ Slate. 4 Pieces.
Untersetzer Set. Bambus/ Schiefer. 4 Stück.
Set Sous-Verre. Bambou/ Ardoise. 4 Pièces.
Onderzetter Set. Bamboe/ Leisten. 4 Stuks.

📏 Ø 11.5 x 5.1 cm 📦 20 🏷️ Print Code: E(1), L1



Derrol 1654

Coaster Set. Wood/ Marble Extract. 2 Pieces.
Untersetzer Set. Holz/ Marmor Extrakten. 2 Stück.
Set Sous-Verre. Bois/ Extrait Marbre. 2 Pièces.
Onderzetter Set. Hou/ Marmer-Extracten. 2 Stuks.

📏 12 x 11.5 x 3.6 cm 📦 40 🏷️ Print Code: E(1), L2

ACACIA
Wood



Gladen 1701



Mugs Set. 2 Mugs Borosilicate Glass 90 ml. 2 Coasters Bamboo.

Tassen Set. 2 Tassen Borosilikat Glas 90 ml. 2 Untersetzer Bambus.

Set Tasses. 2 Tasses Verre Borosilicate 90 ml. 2 Sous-Verre Bambou.

Mokken Set. 2 Mokken Borosilicate Glas 90 ml. 2 Onderzetter Bamboe.

18.8 x 6.5 x 10 cm 25 Print Code: E(1), L2



SET



Morkel 6482

Set. Borosilicate Glass/ Bamboo. 180 ml. 3 Pieces.

Set. Borosilikat Glas/ Bambus. 180 ml. 3 Stück.

Set. Verre Borosilicate/ Bambou. 180 ml. 3 Pièces.

Set. Borosilicate Glas/ Bamboe. 180 ml. 3 Stuks.

16.4 x 8 x 12.3 cm 50 Print Code: F(1), C(4), L2



Kipal 6481

Mug. Borosilicate Glass/ Bamboo. 420 ml.

Tasse. Borosilikat Glas/ Bambus. 420 ml.

Tasse. Verre Borosilicate/ Bambou. 420 ml.

Mok. Borosilicate Glas/ Bamboe. 420 ml.

Ø 8.7 x 10.6 cm 50 Print Code: F(1), C(4), L1, L2



Yirax 1216

Mug. Glass/ Bamboo. 420 ml.

Tasse. Glas/ Bambus. 420 ml.

Tasse. Verre/ Bambou. 420 ml.

Mok. Glas/ Bamboe. 420 ml.

13.3 x 10.7 x 13 cm 20 Print Code: F(1), C(4), L1, L2





Zirkony 1129

Tea Storage Box. Bamboo. 4 Compartments.
Teebox. Bambus. 4 Abteilungen.
Boîte à Thé. Bambou. 4 Compartiments.
Theedoo's. Bamboe. 4 Compartimenten.

29.5 x 7.5 x 8.5 cm 20 Print Code: E(1), L2



450 ml

Masty 1073

Tea Mug. Borosilicate Glass/ Bamboo. 450 ml. Infuser Included.
Tee Tasse. Borosilikat Glas/ Bambus. 450 ml. Inklusive Teesieb.
Tasse à Thé. Verre Borosilicate/ Bambou. 450 ml. Infuseur Inclusif.
Thee Mok. Borosilicate Glas/ Bamboe. 450 ml. Thee-Ei Inclusief.

Ø 8 x 12.5 cm 30 Print Code: F(1), L2



1L

Talia 6998

Teapot. Borosilicate Glass/ Bamboo. 1 L. Stainless Steel Infuser Included.
Teekanne. Borosilikat Glas/ Bambus. 1 L. Inklusive Rostfreier Stahl Teesieb.
Théière. Verre Borosilicate/ Bambou. 1 L. Infuseur Acier Inox Inclusif.
Theepot. Borosilicate Glas/ Bamboe. 1 L. Roestvrij Staal Thee-Ei Inclusief.

21 x 13 x 12.5 cm 20 Print Code: F(1), L1



Hanay 1709

Infuser. Glass/ Cork.
Teesieb. Glas/ Kork.
Infuseur. Verre/ Liège.
Thee-Ei. Glas/ Kurk.

Ø 2.9 x 13.3 cm 200 / 50 Print Code: F(1), L1



1L

400 ml

Global Recycled Standard

GLASS

800 ml



Made in Europe

Hasleg 2648

Set. Recycled Glass. Bottle 1 L. 2 Glasses 400 ml.
 Set. Recycling Glas. Trinkflasche 1 L. 2 Trinkbecher 400 ml.
 Set. Verre Recyclé. Bouteille 1 L. 2 Verres 400 ml.
 Set. Gerecycled Glas. Fles 1 L. 2 Glasses 400 ml.

20 x 27 x 10 cm 4 Print Code: F(1), L2



Limpix 2647

Bottle. Recycled Glass. 1 L.
 Trinkflasche. Recycling Glas. 1 L.
 Bidon. Verre Recyclé. 1 L.
 Fles. Gerecycled Glas. 1 L.

Ø 9,5 x 26 cm 6 Print Code: F(1), L2



Zaslet 2649

Bottle. Recycled Glass. 800 ml.
 Trinkflasche. Recycling Glas. 800 ml.
 Bouteille. Verre Recyclé. 800 ml.
 Fles. Gerecycled Glas. 800 ml.

Ø 9,7 x 25 cm 6 Print Code: F(1), L2

Dibrix 1703

Jug. Borosilicate Glass/ Bamboo. 1,25 L.
Krug. Borosilikat Glas/ Bambus. 1,25 L.
Carafe. Verre Borosilicate/ Bambou. 1,25 L.
Kan. Borosilicate Glas/ Bamboe. 1,25 L.

☞ Ø 8.8 × 24.2 cm ☞ 20 ☞ Print Code: F(1), L2



1,25 L

1,35 L



WAVE

WAVE

320 ml

Malister 1704

Set. Glas. 4 Cups Glass 320 ml. Jug 1,35 L.
Set. Glas. 4 Trinkbecher Glas 320 ml. Krug 1,35 L.
Set. Verre. 4 Verres 320 ml. Carafe 1,35 L.
Set. Glas. 4 Beker Glas 320 ml. Kan 1,35 L.

☞ 26.4 × 28 × 9.7 cm ☞ 8 ☞ Print Code: F(1)



800 ml

1 L



Ricadel 1394

Bottle. Borosilicate Glass/ Cork. 800 ml.
Trinkflasche. Borosilikat Glas/ Kork. 800 ml.
Bidon. Verre Borosilicate/ Liège. 800 ml.
Fles. Borosilicate Glas/ Kurk. 800 ml.

☞ Ø 8.2 × 21 cm ☞ 20
☞ Print Code: F(1), L2

Lonpel 6580

Bottle. Glass/ Cork. 1 L.
Trinkflasche. Glas/ Kork. 1 L.
Bouteille. Verre/ Liège. 1 L.
Fles. Glas/ Kurk. 1 L.

☞ Ø 9.3 × 27.2 cm ☞ 20
☞ Print Code: F(1), L2



Hernan 1070

Cup. Glass. 500 ml.
Trinkbecher. Glas. 500 ml.
Verre. Verre. 500 ml.
Beker. Glas. 500 ml.

☞ Ø 6.4 × 11.8 cm ☞ 50
☞ Print Code: F(1), L2

500 ml

Merzex 1254

Cup. Glass. 320 ml.
Trinkbecher. Glas. 320 ml.
Verre. Verre. 320 ml.
Beker. Glas. 320 ml.

☞ Ø 7.3 × 9.6 cm ☞ 50
☞ Print Code: F(1), L2

320 ml





350 ml

Devon 1393

Whisky Set. Bamboe. Cup Glass 350 ml. 2 Ice Cubes Stainless Steel Reusable. Stainless Steel Tongs. Coaster Bamboe.

Whisky Set. Bambus. Trinkbecher Glas 350 ml. 2 Eiswürfel Rostfreier Stahl Wiederverwendbar. Rostfreier Stahl Zange. Untersetzer Bamboe.

Set Whisky. Bamboe. Verre 350 ml. 2 Glaçons Acier Inox Réutilisables. Pincès Acier Inox. Sous-Verre Bamboe.

Whisky Set. Bamboe. Beker Glas 350 ml. 2 Ijsblokjes Roestvrij Staal Herbruikbaar. Roestvrij Staal Ijsblokjes-Tang. Onderzetter Bamboe.

20.8 x 14.5 x 10 cm 10 Print Code: F(1), L2

Rockwel 1705

Whisky Set. Glass. Decanter 1 L. 4 Cups 200 ml.
Whisky Set. Borosilikat. Dekanter 1 L. 4 Trinkbecher Glas 200 ml.
Set Whisky. Verre. Décanteur 1 L. 4 Verres 200 ml.
Whisky Set. Glas. Decanteerder 1 L. 4 Beker 200 ml.

31 x 27 x 12 cm 8 Print Code: F(1), L2



1L

200 ml



New

550 ml

Hunton 20802

Cocktail Set. Bamboe/ Stainless Steel. Cocktail Shaker 550 ml. 9 Accessories.

Cocktail Set. Bambus/ Rostfreier Stahl. Shaker 550 ml. 9 Teile.

Set Cocktail. Bamboe/ Acier Inox. Shaker 550 ml. 9 Accessoires.

Cocktail Set. Bamboe/ Roestvrij Staal. Shaker 550 ml. 9 Accessoires.

28 x 26.5 x 10.5 cm 10 Print Code: H(1), L2



320 ml

Steger 1706

Whisky Set. Bamboe. 2 Cups Glass 320 ml. 8 Ice Cubes Natural Stone Reusable. Stainless Steel Tongs. Cotton Pouch.

Whisky Set. Bambus. 2 Trinkbecher Glas 320 ml. 8 Eiswürfel Naturstein Wiederverwendbar. Rostfreier Stahl Zange. Baumwolle Etui.

Set Whisky. Bamboe. 2 Verres 320 ml. 8 Glaçons Pierre Naturelle Réutilisables. Pincès Acier Inox. Étui Coton.

Whisky Set. Bamboe. 2 Beker Glas 320 ml. 8 Ijsblokjes Natuursteen Herbruikbaar. Roestvrij Staal Ijsblokjes-Tang. Katoen Zakje.

21.5 x 10.5 x 19.5 cm 8 Print Code: F(1), L2



Neider 1707

Wine Set. Bamboo. 2 Wine Glass 350 ml. Corkscrew Opener Stainless Steel.
 Wein Set. Bambus. 2 Weinglas 350 ml. Korkenzieher Flaschenöffner Rostfreier Stahl.
 Set Vin. Bambou. 2 Verres à Vin 350 ml. Tire-Bouchon Ouvre Boutelle Acier Inox.
 Wijn Set. Bamboe. 2 Wijnglas 350 ml. Kurkretrekker Opener Roestvrij Staal.

21.9 x 24 x 10.8 cm 8 Print Code: F(1), L2



Seirten 1280

Wine Decanter. Borosilicate Glass/ Cork. 1.7 L.
 Wein Dekanter. Borosilikat Glas/ Kork. 1.7 L.
 Décanteur. Verre Borosilicate/ Liège. 1.7 L.
 Decanteerder. Borosilicate Glas/ Kurk. 1.7 L.

14 x 25 cm 20 Print Code: G(1), L2



Klein 1274

Bottle Holder. Wood. Foldable.
 Flaschenhalter. Holz. Faltbar.
 Porte-Bouteilles. Bois. Pliable.
 Flessenhouder. Hout. Opvouwbaar.

13 x 46.5 x 2 cm 20
 Print Code: E(1), L1



Magnetic Opener



Betriok 1493

Opener. Bamboo. Magnetic.
Flaschenöffner. Bambus. Magnetisch.
Ouvre Bouteille. Bambou. Magnétique.
Opener. Bamboe. Magnetisch.

▮ 6 x 1.1 cm 📦 500 / 50 🏷️ Print Code: D(4), L1, W



Strol 20594

Opener. Bamboo. Magnetic.
Flaschenöffner. Bambus. Magnetisch.
Ouvre Bouteille. Bambou. Magnétique.
Opener. Bamboe. Magnetisch.

▮ 3.7 x 7 x 1 cm 📦 200 / 100
🏷️ Print Code: D(4), L1, W



Perring 1653

Corkscrew Opener. Bamboo. Magnetic.
Korkenzieher Flaschenöffner. Bambus. Magnetisch.
Tire-Bouchon Ouvre Bouteille. Bambou. Magnétique.
Kurkretrekker Opener. Bamboe. Magnetisch.

▮ 4.1 x 13.6 x 1.8 cm 📦 100 / 50 🏷️ Print Code: D(4), L1, W

Nadim 1750

Clip Opener. Bamboo. Magnetic.
Clip Flaschenöffner. Bambus. Magnetisch.
Ouvre Bouteille Clip. Bambou. Magnétique.
Clip Opener. Bamboe. Magnetisch.

▮ 4.5 x 14.4 x 1.2 cm 📦 200 / 50 🏷️ Print Code: D(4), L1, W

Samary 2679

Opener. Wood. Magnetic.
Flaschenöffner. Holz. Magnetisch.
Ouvre Bouteille. Bois. Magnétique.
Opener. Hout. Magnetisch.

▮ 5.9 x 12.8 x 0.9 cm 📦 300 / 50 🏷️ Print Code: D(4), L1





Nacul 6478

Opener. Wood.
Flaschenöffner. Holz.
Ouvre Boutelle. Bois.
Opener. Hout.

4 x 14.4 x 2.2 cm 200 / 50 Print Code: D(4), L1, W



Lavip 6788

Corkscrew Opener. Bamboo Fibre/ ABS.
Korkenzieher Flaschenöffner. Bambusfaser/ ABS.
Tire-Bouchon Ouvre Boutelle. Fibre Bambou/ ABS.
Kurkretrekker Opener. Bamboe Fibre/ ABS.

4 x 13.6 x 2 cm 100 / 10 Print Code: D(4)



Nogurix 20584

Opener. Wheat Straw/ ABS. Magnetic.
Flaschenöffner. Weizenstroh/ ABS. Magnetisch.
Ouvre Boutelle. Paille de Blé/ ABS. Magnétique.
Opener. Tarvestro/ ABS. Magnetisch.

5 x 10.6 x 0.5 cm 600 / 100 Print Code: C(4), W



MAGNETIC



Tronic 3403

Opener. Magnetic.
Flaschenöffner. Magnetisch.
Ouvre Boutelle. Magnétique.
Opener. Magnetisch.

5 x 10.6 x 0.5 cm 600 / 100
Print Code: D(1), W



01



Nolix 3793

Corkscrew. Magnetic.
Korkenzieher. Magnetisch.
Tire-Bouchon. Magnétique.
Kurkretrekker. Magnetisch.

Ø 2.5 x 11.5 cm 200 / 20 Print Code: D(1)



MAGNETIC



Mac 9514

Corkscrew.
Korkenzieher.
Tire-Bouchon.
Kurkretrekker.

2.2 x 11 x 1.2 cm 240 / 10 Print Code: D(1)



03



11

19

02

04

07

Yupit 3922

Magnetic Whiteboard. Felt Tip Pen and Eraser Included.
Magnet Tafel. Filzstift und Radierer Inklusiv.
Ardoise Magnétique. Feutre et Effaceur Incluses.
Magnetisch Whiteboard. Felt Tip Pen en Gum Inclusief.

9.9 x 15 cm 200 / 25 Print Code: D(4)



03



05



05

07

03

19

11

Yakari 4582

Magnet. 40 Sheets Notepad. Pencil Included.
Magnet. 40 Blätter Notizblock. Bleistift Inklusiv.
Magnet. Bloc 40 Feuilles. Crayon Inclus.
Magneet. 40 Blaadjes Notepad. Potlood Inclusief.

9.9 x 14 cm 200 / 50 Print Code: C(4)



01



04

Recycled Paper



Kibly 1387

Magnet. Recycled Paper. 40 Sheets Notepad. Pencil Included.
Magnet. Recycling Papier. 40 Blätter Notizblock. Bleistift Inklusiv.
Magnet. Papier Recyclé. Bloc 40 Feuilles. Crayon Inclus.
Magneet. Gerecycled Papier. 40 Blaadjes Notepad. Potlood Inclusief.

9.9 x 14 cm 200 / 50 Print Code: C(2)



Dashin 1015

Magnet. Recycled Paper.
Magnet. Recycling Papier.
Magnet. Papier Recyclé.
Magneet. Gerecycled Papier.

6 x 6 cm 3000 / 100 Print Code: C(4), W



Tunip 1016

Magnet Photo Frame. Recycled Paper. Photos Size: 8,5 x 9 cm.
Magnet Bilderrahmen. Recycling Papier. Photos: 8,5 x 9 cm.
Porte Photos Aimanté. Papier Recyclé. Photos: 8,5 x 9 cm.
Magneet Fotolijst. Gerecycled Papier. Foto's Maat: 8,5 x 9 cm.

11 x 14,5 cm 500 / 100 Print Code: C(4), W



 Made in Europe

Talier 2678

Magnet. Wood.
Magnet. Holz.
Magnet. Bois.
Magneet. Hout.

 8 x 5.3 cm  800 / 200  Print Code: C(4), L1, W



Lirix 20597



Magnet Set. Bamboo. 12 Pieces. Cotton Pouch.
Magnet Set. Bambus. 12 Stück. Baumwolle Etui.
Set Magnets. Bambou. 12 Pièces. Étui Coton.
Magneet Set. Bamboe. 12 Stuks. Katoen Zakje.

 8.5 x 11 cm  100 / 50  Print Code: B(1), E(1), L1, N(8)



Cutum 1025

Keyring. Metal/ Bamboo.
Schlüsselanhänger. Metall/ Bambus.
Porte-Clés. Métal/ Bambou.
Sleutelhanger. Metaal/ Bamboe.

 4.4 x 4.3 x 0.4 cm  200 / 50  Print Code: D(1), L1



Amuni 21012



Keyring. Cork.
Schlüsselanhänger. Kork.
Porte-Clés. Liège.
Sleutelhanger. Kurk.

 5.4 x 4.7 x 0.7 cm  1000 / 100  Print Code: D(1), L1



Yenen 1961

Weather Station. Bamboo. Button Battery Included.
Wetterstation. Bambus. Knopfzelle Inklusive.
Station Météo. Bambou. Pile Bouton Incluse.
Weerstation. Bamboe. Knooppcel Batterij Inclusief.

 9 x 12 x 2.3 cm  100 / 50  Print Code: D(4), L1

Small,
Everyday
Actions for
Energy
Saving and
Efficiency

Every
Action
Counts



05

04

19

Kerman 4002

Spatula. Silicone.
Spatel. Silikon.
Spatule. Silicone.
Spatel. Siliconen.

3.5 x 23 x 1 cm 500 / 50 Print Code: D(1)



03

Kolam 4001

Brush. Silicone.
Pinsel. Silikon.
Pinceau. Silicone.
Kwast. Siliconen.

3 x 17.5 x 1 cm 600 / 50 Print Code: D(1)



03



05



19



03



01

19

04

Flint 5793

Clip.
Klammer.
Pince.
Knijper.

10 x 6.2 x 2.3 cm 500 / 50 Print Code: C(1)



11

19

04

05

03

07



01

Revey 3779

Timer.
Timer.
Minuteur.
Eierwekker.

6 x 7.5 cm 100 / 20 Print Code: D(4)

Recycling Bags



Lopack 4264

Bag Set, Laminated Non-Woven, 3 Bags 23 x 45 x 23 cm.
Taschen Set, Laminiertes Non-Woven, 3 Taschen 23 x 45 x 23 cm.
Set Sacs, T.N.T. Laminé, 3 Sacs 23 x 45 x 23 cm.
Tassen Set, Gelamineerd Non-Woven, 3 Tassen 23 x 45 x 23 cm.

69 x 45 x 23 cm 50 Print Code: G(1)



Stuggar 1711

Bag Set, Laminated Polyester RPET, 3 Bags 23 x 45 x 23 cm.
Taschen Set, Laminiertes Polyester RPET, 3 Taschen 23 x 45 x 23 cm.
Set Sacs, Polyester RPET Laminé, 3 Sacs 23 x 45 x 23 cm.
Tassen Set, Gelamineerd Polyester RPET, 3 Tassen 23 x 45 x 23 cm.

69 x 45 x 23 cm 50 Print Code: G(1)





New

Mimbis 20586

Peeler. PP.
Schäler. PP.
Éplucheur. PP.
Schiller. PP.

6 x 13.3 x 1.5 cm 400 / 100 Print Code: C(4)



Products of food grade
quality certified.



New

Barlak 20573

Kitchen Cutting Board. PP.
Brett. PP.
Planche à Découper. PP.
Keuken Snijplank. PP.

14 x 23.8 x 0.4 cm 200 / 100 Print Code: D(1)



New

Miquelson 21051

Kitchen Cutting Board Set. PP. 4 Pieces.
Brett Set. PP. 4 Stück.
Set Planche à Découper. PP. 4 Pièces.
Keuken Snijplank Set. PP. 4 Stuks.

24 x 32.8 x 7.7 cm 10 Print Code: E(1), F(1)





.....● LIGHT

Cinder 20592

Electric Salt and Pepper Mill. Stainless Steel. 1 Led. Adjustable Grinder. 4 Batteries AAA Not Included.
Elektrischer Salz- und Pfeffermühle. Rostfreier Stahl. 1 Led. Einstellbare Schleifer. 4 AAA Batterien Nicht im Lieferumfang.
Moulin à Sel et Poivre Électrique. Acier Inox. 1 Led. Meuleuse Réglable. 4 Piles AAA Non Incluses.
Elektrische Zout- en Pepermolen. Roestvrij Staal. 1 Led. Stijper Instelbare. 4 Batterijen AAA Niet Inclusief.

..... Ø 8 x 19 cm 30 Print Code: L1



Salt & Pepper

New



Narsak 21100

Salt and Pepper Mill. Aluminium.
Salt- und Pfeffermühle. Aluminium.
Moulin à Sel et Poivre. Aluminium.
Zout- en Pepermolen. Aluminium.

..... Ø 2.8 x 15.2 cm 100 / 50 Print Code: E(1), L1



Jasper 20581

Milk Frother. ABS/ Stainless Steel. 2 Batteries AA Not Included.
Milchaufschäumer. ABS/ Rostfreier Stahl. 2 AA Batterien Nicht im Lieferumfang.
Mousseur à lait. ABS/ Acier Inox. 2 Piles AA Non Incluses.
Melkopschuimer. ABS/ Roestvrij Staal. 2 Batterijen AA Niet Inclusief.

..... 2.3 x 20 x 3.5 cm 50 Print Code: D(1)



Fruver 1939

Blender. 380 ml. Batterie 2000 mAh.
Blender. 380 ml. Batterie 2000 mAh.
Mélangeur. 380 ml. Batterie 2000 mAh.
Blender. 380 ml. Batterie 2000 mAh.

..... Ø 8 x 23.5 cm 25 Print Code: F(1)

380 ml





03



125

19

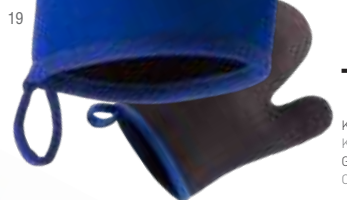

02

07



03

11

Piper 9063

Kitchen Mitts. 100% Cotton. One Flat Side for Printing.
 Küchenhandschuh. 100% Baumwolle. Eine flache Seite zum Bedrucken.
 Gant Cuisine. 100% Coton. Un Côté Lisse pour Impression.
 Ovenwant. 100% Katoen. Eén Platte Zijde Voor Bedrukking.

18 x 28.5 cm 200 / 25 Print Code: F(1), N(8)



19

Tosha 4537

Kitchen Mitts. Polyester/ Neoprene. One Flat Side for Printing.
 Küchenhandschuh. Polyester/ Neopren. Eine flache Seite zum Bedrucken.
 Gant Cuisine. Polyester/ Néoprène. Un Côté Lisse pour Impression.
 Ovenwant. Polyester/ Neopreen. Eén Platte Zijde Voor Bedrukking.

18 x 26 cm 200 / 50 Print Code: F(1), N(8)



03



02



02



04



11



06



05



07



SUBLIMATION



19

03



SUBLIMATION



03

19

Leston 5021

Kitchen Set. TC. 35% Cotton/ 65% Polyester. 2 Pieces. One Flat Side for Printing.
 Küchen Set. TC. 35% Baumwolle/ 65% Polyester. 2 Stück. Eine flache Seite zum Bedrucken.
 Set Cuisine. TC. 35% Coton/ 65% Polyester. 2 Pièces. Un Côté Lisse pour Impression.
 Keuken Set. TC. 35% Katoen/ 65% Polyester. 2 Stuks. Eén Platte Zijde Voor Bedrukking.

Consult. 100 / 10 Print Code: F(1), N(8)

Silax 5215

Kitchen Mitts. 100% Polyester. One Flat Side for Printing.
 Küchenhandschuh. 100% Polyester. Eine flache Seite zum Bedrucken.
 Gant Cuisine. 100% Polyester. Un Côté Lisse pour Impression.
 Ovenwant. 100% Polyester. Eén Platte Zijde Voor Bedrukking.

18 x 28 cm 200 / 50 Print Code: F(1), N(8), R

Kalmont 5214

Pot Holder. 100% Polyester. One Flat Side for Printing.
 Topflappen. 100% Polyester. Eine flache Seite zum Bedrucken.
 Manique. 100% Polyester. Un Côté Lisse pour Impression.
 Pannentap. 100% Polyester. Eén Platte Zijde Voor Bedrukking.

17 x 17 cm 200 / 50 Print Code: E(1), N(8), R



RECYCLED
COTTON

Cafar 1717

13

Kitchen Mitten. 100% Recycled Cotton. One Flat Side for Printing.
Küchenhandschuh. 100% Recycling Baumwolle. Eine Flache Seite zum Bedrucken.
Gant Cuisine. 100% Coton Recyclé. Un Côté Lisse pour Impression.
Ovenwant. 100% Gerecycled Katoen. Eén Platte Zijde Voor Bedrukking.

18 x 28.5 cm

200 / 25

Print Code: F(1), N(8)



Calen 6469

Kitchen Mitten. 100% Organic Cotton. One Flat Side for Printing.
Küchenhandschuh. 100% Organische Baumwolle. Eine Flache Seite zum Bedrucken.
Gant Cuisine. 100% Coton Organique. Un Côté Lisse pour Impression.
Ovenwant. 100% Organisch Katoen. Eén Platte Zijde Voor Bedrukking.

18 x 28.5 cm

200 / 25

Print Code: F(1), N(8)



Kalose 1716

Kitchen Mitten. 100% Polyester RPET. One Flat Side for Printing.
Küchenhandschuh. 100% Polyester RPET. Eine Flache Seite zum Bedrucken.
Gant Cuisine. 100% Polyester RPET. Un Côté Lisse pour Impression.
Ovenwant. 100% Polyester RPET. Eén Platte Zijde Voor Bedrukking.

18 x 28.5 cm

200 / 25

Print Code: F(1), N(8)



ORGANIC
COTTON

RPET



02

Xigor 4746

Apron. TC. 35% Cotton/ 65% Polyester.
 Schürze. TC. 35% Baumwolle/ 65% Polyester.
 Tablier. TC. 35% Coton/ 65% Polyester.
 Schort. TC. 35% Katoen/ 65% Polyester.

📏 65 x 90 cm 📦 100 / 10
 🏷️ Print Code: F(4), N(8), P



03

Konner 6051

Apron. TC. 20% Cotton/ 80% Polyester.
 Schürze. TC. 20% Baumwolle/ 80% Polyester.
 Tablier. TC. 20% Coton/ 80% Polyester.
 Schort. TC. 20% Katoen/ 80% Polyester.

📏 70 x 95 cm 📦 100 / 10
 🏷️ Print Code: F(4), N(8), P, R



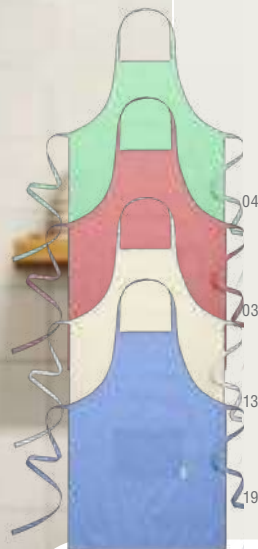

RECYCLED COTTON



623

HOME ESSENTIALS



Pissek 6831

Apron. 100% Recycled Cotton.
Schürze. 100% Recycling Baumwolle.
Tablier. 100% Coton Recyclé.
Schort. 100% Gerecycled Katoen.

65 x 90 cm 100 / 10 Print Code: F(4), N(8), P

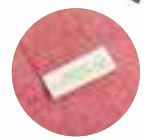

Bacatus 3897

Apron. TC. 35% Cotton/ 65% Polyester.
Schürze. TC. 35% Baumwolle/ 65% Polyester.
Tablier. TC. 35% Coton/ 65% Polyester.
Schort. TC. 35% Katoen/ 65% Polyester.

65 x 90 cm 100 / 50 Print Code: F(4), N(8), P



Maylon 6206

Apron. 100% Cotton.
Schürze. 100% Baumwolle.
Tablier. 100% Coton.
Schort. 100% Katoen.

65 x 90 cm 100 / 10 Print Code: F(4), N(8), P



Rober 6954

Apron. 100% Cotton.
Schürze. 100% Baumwolle.
Tablier. 100% Coton.
Schort. 100% Katoen.

68 x 80 cm 50
Print Code: G(4), N(8), P



ADJUSTABLE STRAPS



Yorrent 1714

Apron. 100% Cotton/ PU.
Schürze. 100% Baumwolle/ PU.
Tablier. 100% Coton/ Similicuir.
Schort. 100% Katoen/ PU.

68 x 90 cm 30
Print Code: G(4), N(8), P

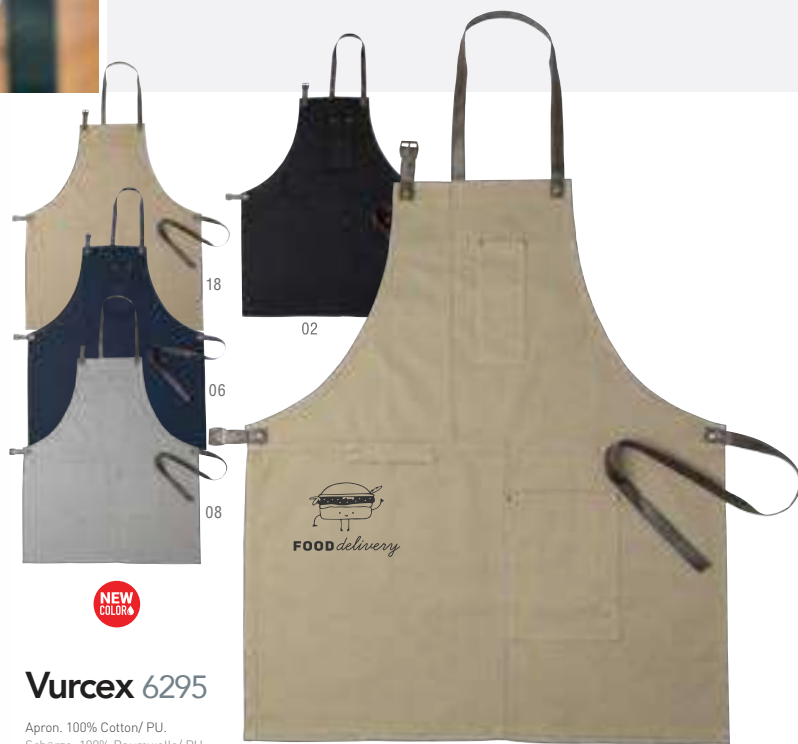

NEW COLOR

Vurcex 6295

Apron. 100% Cotton/ PU.
Schürze. 100% Baumwolle/ PU.
Tablier. 100% Coton/ Similicuir.
Schort. 100% Katoen/ PU.

68 x 80 cm 50
Print Code: G(4), N(8), P



ORGANIC
COTTON



18



06

Kuirtel 1399

Apron. 100% Organic Cotton.
Schürze. 100% Organische Baumwolle.
Tablier. 100% Coton Organique.
Schort. 100% Organisch Katoen.

65 x 90 cm 50 Print Code: G(4), N(8), P



Riffox 6425

Apron. 100% Organic Cotton.
Schürze. 100% Organische Baumwolle.
Tablier. 100% Coton Organique.
Schort. 100% Organisch Katoen.

65 x 90 cm 100 / 10 Print Code: F(4), N(8), P



Zowi Fairtrade 1270

Apron. 100% Cotton.
Schürze. 100% Baumwolle.
Tablier. 100% Coton.
Schort. 100% Katoen.

65 x 90 cm 100 / 10 Print Code: F(4), N(8), P



02

Nilson 4747

Chef Hat. TC. 35% Cotton/ 65% Polyester. Adjustable.
 Kochmütze. TC. 35% Baumwolle/ 65% Polyester. Verstellbar.
 Toque Cuisinier. TC. 35% Coton/ 65% Polyester. Ajustable.
 Koksmuts. TC. 35% Katoen/ 65% Polyester. Aanpasbaar.

Consult. 250 / 50 Print Code: E(1), N(8)



01

Milty 4870

Apron. 100% Polyester.
 Schürze. 100% Polyester.
 Tablier. 100% Polyester.
 Schort. 100% Polyester.

54 x 30 cm 200 / 25 Print Code: F(1), N(8)



05

04

11



01

02

19



03

Vanur 4168

Apron. Non-Woven.
 Schürze. Non-Woven.
 Tablier. T.N.T..
 Schort. Non-Woven.

50 x 73 cm 200 / 10 Print Code: F(1)



Salmux 6114

Sublimation Apron. Non-Woven.
 Sublimations Schürze. Non-Woven.
 Tablier Sublimation. T.N.T..
 Sublimatie Schort. Non-Woven.

50 x 73 cm 200 / 50 Print Code: F(1), N(8), R



SUBLIMATION

HEMP



RPET ♻️



04



13

Leiza 1154

Apron. 100% Hemp Fabric.
Schürze. 100% Hanf-Stoff.
Tablier. 100% Tissu de Chanvre.
Schort. 100% Hennep Stof.

65 x 90 cm 100 / 10 Print Code: F(1), N(8), P

**Hanaku 1715**

Apron. 100% Polyester RPET/ PU.
Schürze. 100% Polyester RPET/ PU.
Tablier. 100% Polyester RPET/ Similicuir.
Schort. 100% Polyester RPET/ PU.

70 x 95 cm 80 / 10 Print Code: F(1), N(8)



Vorad 1962

Timer. Button Battery Included.
 Timer. Knopfzelle Inklusive.
 Minuteur. Pile Bouton Incluse.
 Eierwekker. Knoopcel Batterij Inclusief.

5.6 x 7.3 x 2.3 cm 200 / 50 Print Code: D(4)



Tynna 1963

Weather Station. Magnetic. Button Battery Included.
 Wetterstation. Magnetisch. Knopfzelle Inklusive.
 Station Météo. Magnétique. Pile Bouton Incluse.
 Weerstation. Magnetisch. Knoopcel Batterij Inclusief.

4.6 x 4.5 x 1.6 cm 300 / 50 Print Code: D(4)



Small,
 Everyday
 Actions for
 Energy
 Saving and
 Efficiency

Every Action Counts



Durden 20869

Mini Heater. 600W. AC 220-240V.
 Mini Heizung. 600W. AC 220-240V.
 Mini Chauffage. 600W. AC 220-240V.
 Mini Verwarmer. 600W. AC 220-240V.

13.5 x 13.5 x 11.5 cm 20 Print Code: G(1)



Rariax 4929



Speaker. Bluetooth Connection. Sound Power 3W. Battery 300 mAh.
 Lautsprecher. Bluetooth Anschluss. Schallleistung 3W. Batterie 300 mAh.
 Haut-Parleur. Connexion Bluetooth. Puissance Sonore 3W. Batterie 300 mAh.
 Luidspreker. Bluetooth Verbinding. Geluidsvermogen 3W. Batterij 300 mAh.

8.5 x 5.5 cm 50 Print Code: F(1)



Koleva 20599

Towel. 100% Organic Cotton 350 g/ m².
 Handtuch. 100% Organische Baumwolle 350 g/ m².
 Serviette. 100% Coton Organique 350 g/ m².
 Handdoek. 100% Organisch Katoen 350 g/ m².

140 x 70 cm 20
 Print Code: F(1), N(8), O, P

TERRY TOWEL



140 x 70 cm



Canoria 20598

Towel. 100% Organic Cotton 350 g/ m².
 Handtuch. 100% Organische Baumwolle 350 g/ m².
 Serviette. 100% Coton Organique 350 g/ m².
 Handdoek. 100% Organisch Katoen 350 g/ m².

100 x 50 cm 30
 Print Code: F(1), N(8), O, P

TERRY TOWEL



100 x 50 cm



Berry 1210



Weighing Scales. Bamboo. 2 Batteries AAA Not Included.
 Waage. Bambus. 2 AAA Batterien Nicht im Lieferumfang.
 Balance. Bambou. 2 Piles AAA Non Incluses.
 Weegschaal. Bamboe. 2 Batterijen AAA Niet Inclusief.

30 x 3 x 30 cm 10 Print Code: E(1), L2



New

Seido 20543

Bathroom Set. 4 Accessories. Cotton Pouch.
 Badezimmer-Set. 4 Teile. Baumwolle Etui.
 Set de Bains. 4 Accessoires. Étui Coton.
 Badkamerset. 4 Accessoires. Katoen Zakje.

15 x 20 x 5 cm 50 Print Code: D(1), F(1), L1, N(8)



16 **BARWARE** & HOTEL ACCESSORIES





**SERVICE,
DEDICATION,
GOURMET**

WOOD



New

Alborix 20815

Organizer. Wood.
Ordner. Holz.
Organiseur. Bois.
Organizer. Hout.

22.5 x 30.5 x 1.7 cm 40 / 20 Print Code: F(1), L2



New

Hyrokin 20814

Display Stand. Wood/ MDF.
Graphic Rahmen. Holz/ MDF.
Support Graphique. Bois/ MDF.
Display Standaard. Hout/ MDF.

15 x 22.7 x 3 cm 50 Print Code: D(1), L2



New

Yingo 20817

Napkin Holder. Wood.
Serviettenhalter. Holz.
Porte-Serviettes. Bois.
Serviettenhouder. Hout.

12 x 11 x 12 cm 20 Print Code: E(1), L2, W

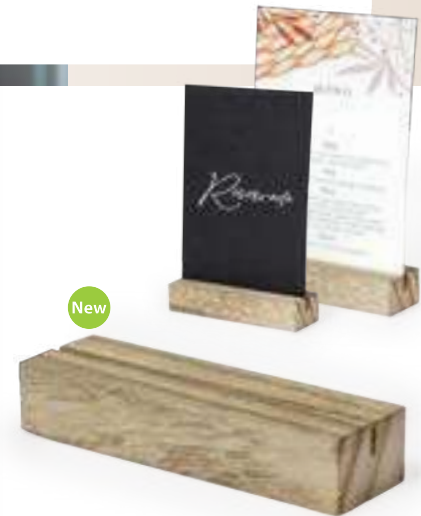

New

Keil 20816

Holder. Wood.
Halter. Holz.
Support. Bois.
Houder. Hout.

10 x 2 x 3 cm 500 / 100 Print Code: C(4), L1

DISPLAY NOT INCLUDED



Tonend 20818

Ice Bucket. Wood/ Stainless Steel. 3 L.
Eiskübel. Holz/ Rostfreier Stahl. 3 L.
Seau Glaçons. Bois/ Acier Inox. 3 L.
Ijs Emmer. Hout/ Roestvrij Staal. 3 L.

Ø 23 x 24 cm 6 Print Code: J(f), L3



Meltem 20819

Tray. Bamboo.
Tablett. Bambus.
Plateau. Bambou.
Dienblad. Bamboe.

Ø 35 x 5 cm 10 Print Code: F(f), L3



Drivix 20820

Bar Runner. Bamboo. Anti-Slip.
Barmatte. Bambus. Rutschfest.
Tapis de Bar. Bambou. Antidérapant.
Barmat. Bamboe. Anti-Slip.

62.5 x 1.3 x 8.9 cm 20 Print Code: E(f), L2



Seloria 20587

Bread Basket. Jute/ Cotton.
Brotkorb. Jutestoff/ Baumwolle.
Corbeille. Jute/ Coton.
Broodmand. Jute/ Katoen.

📏 Ø 15 x 20 cm 📦 300 / 100
🖨️ Print Code: F(1), N(8)



Zolar 20588

Bread Basket. Cork/ Cotton.
Brotkorb. Kork/ Baumwolle.
Corbeille. Liège/ Coton.
Broodmand. Kurk/ Katoen.

📏 Ø 15 x 15.5 cm 📦 300 / 100
🖨️ Print Code: F(1), N(8)



TWO SIDES

Marnik 5479

Whiteboard. 3 Chalks, Felt Tip Pen and Eraser Included.
Tafel. 3 Kreiden, Filzstift und Radierer Inklusiv.
Ardoise. 3 Craies, Feutre et Effaceur Incluses.
Whiteboard. 3 Krijtjes, Felt Tip Pen en Gum Inclusief.

📏 31 x 21 x 1.2 cm 📦 50 🖨️ Print Code: E(1), L2



TWO SIDES

Leward 20813

Whiteboard. Wood.
Tafel. Holz.
Ardoise. Bois.
Whiteboard. Hout.

📏 65 x 106 x 59 cm 📦 4 🖨️ Print Code: J(1), L3

New





Clasinger 20812

Opener: Wood, Magnetic.
Flaschenöffner: Holz, Magnetisch.
Ouvre Bouteille: Bois, Magnétique.
Opener: Hout, Magnetisch.

1.9 x 11.3 x 3.5 cm 200 / 100 Print Code: D(4), L1



Ferdy 6477

Opener: Wood.
Flaschenöffner: Holz.
Ouvre Bouteille: Bois.
Opener: Hout.

4 x 17.9 x 1 cm 100 / 50
 Print Code: D(4), L1, W



Nacul 6478

Opener: Wood.
Flaschenöffner: Holz.
Ouvre Bouteille: Bois.
Opener: Hout.

4 x 14.4 x 2.2 cm 200 / 50
 Print Code: D(4), L1, W



Cesaris 20811

Opener: Wood.
Flaschenöffner: Holz.
Ouvre Bouteille: Bois.
Opener: Hout.

2.6 x 10.2 x 1.7 cm 400 / 100
 Print Code: D(4), L1



Betriok 1493

Opener. Bamboe. Magnetisch.
Flaschenöffner. Bambus. Magnetisch.
Ouvre Bouteille. Bamboe. Magnétique.
Opener. Bamboe. Magnetisch.

Ø 6 x 1.1 cm 500 / 50 Print Code: D(4), L1, W



Perring 1653

Corkscrew Opener. Bamboe. Magnetisch.
Korkenzieher Flaschenöffner. Bambus. Magnetisch.
Tire-Bouchon Ouvre Bouteille. Bamboe. Magnétique.
Kurkretrekker Opener. Bamboe. Magnetisch.

4.1 x 13.6 x 1.8 cm 100 / 50 Print Code: D(4), L1, W

Lestral 20810

Opener Coaster. Bamboe.
Flaschenöffner Untersetzer. Bambus.
Sous-Verre Ouvre Bouteille. Bamboe.
Opener Onderzetter. Bamboe.

10 x 10 x 0.9 cm 200 / 50 Print Code: D(4), L2, W



Titox 1272

Pizza Cutter. Bamboe/ Stainless Steel.
Pizzamesser. Bamboe/ Rostfreier Stahl.
Coupe-Pizzas. Bamboe/ Acier Inox.
Pizza Snijder. Bamboe/ Roestvrij Staal.

7.5 x 8.5 x 1.1 cm 200 / 50 Print Code: D(4), L1





Zydris 20792

Corkscrew, Metal/ ABS.
Korkenzieher, Metall/ ABS.
Tire-Bouchon, Métal/ ABS.
Kurkretrekker, Metaal/ ABS.

6.3 x 11 x 0.9 cm

100 / 50

Print Code: D(1)



Noshy 1658

Corkscrew Opener, Stainless Steel.
Korkenzieher Flaschenöffner, Rostfreier Stahl.
Tire-Bouchon Ouvre Boutelle, Acier Inox.
Kurkretrekker Opener, Roestvrij Staal.

12 x 2.1 x 1.3 cm

200 / 10

Print Code: D(1), L1

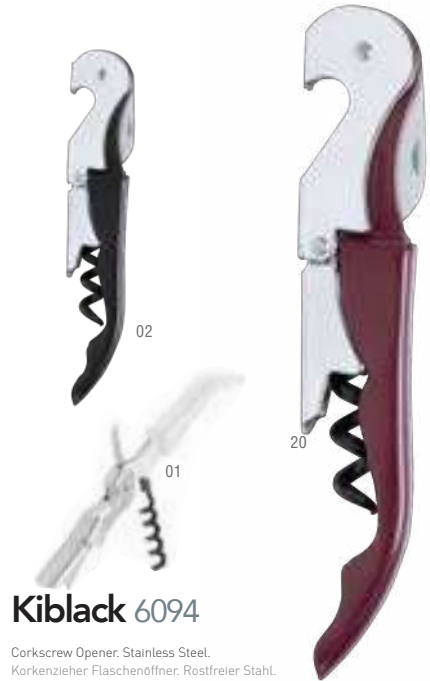

Kiblack 6094

Corkscrew Opener, Stainless Steel.
Korkenzieher Flaschenöffner, Rostfreier Stahl.
Tire-Bouchon Ouvre Boutelle, Acier Inox.
Kurkretrekker Opener, Roestvrij Staal.

2.1 x 12 x 1.3 cm

200 / 10

Print Code: D(4), L1



Flomek 6989

Corkscrew Opener, Bamboo.
Korkenzieher Flaschenöffner, Bambus.
Tire-Bouchon Ouvre Boutelle, Bambou.
Kurkretrekker Opener, Bamboe.

16.5 x 3 x 7 cm

50 / 25

Print Code: E(1)



Glaber 1657

Corkscrew Opener, Cork.
Korkenzieher Flaschenöffner, Kork.
Tire-Bouchon Ouvre Boutelle, Liège.
Kurkretrekker Opener, Kurk.

10.9 x 2.8 x 1.4 cm

100 / 10

Print Code: D(1), L1



Mansen 20809

Corkscrew Opener, Wood.
Korkenzieher Flaschenöffner, Holz.
Tire-Bouchon Ouvre Boutelle, Bois.
Kurkretrekker Opener, Hout.

3.2 x 12.2 x 1.5 cm

100 / 10

Print Code: D(1), L1



New



Mixe 1908

Opener Keyring. Recycled Aluminium.
Schlüsselanhänger Flaschenöffner. Recycling Aluminium.
Porte-Clés Ouvre Bouteille. Aluminium Recyclé.
Seutelhanger Opener. Gerecycled Aluminium.

1.1 x 6 x 1.5 cm 1000 / 100 Print Code: D(4), L1

Stiked 6446

Opener Keyring. Aluminium.
Schlüsselanhänger Flaschenöffner. Aluminium.
Porte-Clés Ouvre Bouteille. Aluminium.
Seutelhanger Opener. Aluminium.

1.1 x 6 x 1.5 cm 1000 / 100 Print Code: D(4), L1

Samo 3911

Opener Keyring. Aluminium.
Schlüsselanhänger Flaschenöffner. Aluminium.
Porte-Clés Ouvre Bouteille. Aluminium.
Seutelhanger Opener. Aluminium.

1.1 x 6.7 x 1.5 cm 1000 / 200 Print Code: D(4), L1



Morley 20578

Opener. Cork.
Flaschenöffner. Kork.
Ouvre Bouteille. Liège.
Opener. Kurk.

3.2 x 8.6 x 0.5 cm 400 / 50
Print Code: D(1), L1



Tronic 3403

Opener. Magnetic.
Flaschenöffner. Magnetisch.
Ouvre Bouteille. Magnétique.
Opener. Magnetisch.

5 x 10.6 x 0.5 cm 600 / 100
Print Code: D(1), W



19



New

Nogurix 20584

Opener. Wheat Straw/ ABS. Magnetic.
Flaschenöffner. Weizenstroh/ ABS. Magnetisch.
Ouvre Bouteille. Paille de Blé/ ABS. Magnétique.
Opener. Tarvestro/ ABS. Magnetisch.

5 x 10.6 x 0.5 cm 600 / 100
Print Code: C(4), W



Gambit 20987

Opener. Recycled Aluminium.
Flaschenöffner. Recycling Aluminium.
Ouvre Bouteille. Aluminium Recyclé.
Opener. Gerecycled Aluminium.

3.8 x 8.5 x 0.3 cm 1000 / 100 Print Code: D(4), L1



Gadux 5062

Opener. Aluminium.
Flaschenöffner. Aluminium.
Ouvre Bouteille. Aluminium.
Opener. Aluminium.

3.8 x 8.5 x 0.3 cm 1000 / 100
Print Code: D(4), L1





02

07

19

Mac 9514

Corkscrew.
Korkenzieher.
Tire-Bouchon.
Kurkretrekker.

2.2 x 11 x 1.2 cm 240 / 10 Print Code: D(1)



03



03

05

Trolex 4503

Corkscrew.
Korkenzieher.
Tire-Bouchon.
Kurkretrekker.

15 x 15.2 x 4 cm 20 Print Code: E(1)



19



02



Lavis 6788

Corkscrew Opener. Bamboo Fibre/ ABS.
Korkenzieher Flaschenöffner. Bambuslaser/ ABS.
Tire-Bouchon Ouvre Bouteille. Fibre Bambou/ ABS.
Kurkretrekker Opener. Bamboe Fibre/ ABS.

4 x 13.6 x 2 cm 100 / 10 Print Code: D(4)



01



20



Joval 6095

Corkscrew Opener.
Korkenzieher Flaschenöffner.
Tire-Bouchon Ouvre Bouteille.
Kurkretrekker Opener.

4 x 13.6 x 2 cm 100 / 10 Print Code: D(4)



02

New

270 ml



Gagax 20129

Flute Glass Set. Stainless Steel. 2 Pieces. 270 ml.
 Glas Set. Rostfreier Stahl. 2 Stück. 270 ml.
 Set Verres. Acier Inox. 2 Pièces. 270 ml.
 Glas Set. Roestvrij Staal. 2 Stuks. 270 ml.

13.5 x 25.5 x 7 cm 30 Print Code: F(1), L1

400 ml



Riberton 1459

Cup. Stainless Steel. 400 ml.
 Trinkbecher. Rostfreier Stahl. 400 ml.
 Verre. Acier Inox. 400 ml.
 Beker. Roestvrij Staal. 400 ml.

Ø 8.4 x 10.8 cm 50 Print Code: F(1), L1



ELECTROPLATING

COOPER COATING

Recubrimiento de cobre galvanizado

New



Indya 20152

Mug. Stainless Steel. 500 ml.
 Tasse. Rostfreier Stahl. 500 ml.
 Tasse. Acier Inox. 500 ml.
 Mok. Roestvrij Staal. 500 ml.

Ø 9.3 x 10 cm 50 Print Code: F(1), L1

500 ml



Keynes 1458

Mug. Stainless Steel. 500 ml.
 Tasse. Rostfreier Stahl. 500 ml.
 Tasse. Acier Inox. 500 ml.
 Mok. Roestvrij Staal. 500 ml.

Ø 9.3 x 10 cm 50 Print Code: F(1), L1

500 ml



New



Belon 20153

Mug. Stainless Steel. 280 ml.
 Tasse. Rostfreier Stahl. 280 ml.
 Tasse. Acier Inox. 280 ml.
 Mok. Roestvrij Staal. 280 ml.

Ø 7.6 x 8.9 cm 50 Print Code: F(1), L1

280 ml



DOUBLE WALL

ALUMINIUM



09 03 02 19



09 03 02 19



09 03 02 19

Amely 20212

Cup. Aluminium. 480 ml.
 Trinkbecher. Aluminium. 480 ml.
 Verre. Aluminium. 480 ml.
 Beker. Aluminium. 480 ml.

☞ Ø 8.5 x 10 cm ☞ 50 ☞ Print Code: F(1), L1

Ashley 20211

Mug. Aluminium. 540 ml.
 Tasse. Aluminium. 540 ml.
 Tasse. Aluminium. 540 ml.
 Mok. Aluminium. 540 ml.

☞ Ø 9.1 x 10.2 cm ☞ 50 ☞ Print Code: F(1), L1

Arlene 20210

Cup. Aluminium. 540 ml.
 Weinglas. Aluminium. 540 ml.
 Verre à Vin. Aluminium. 540 ml.
 Wijn glas. Aluminium. 540 ml.

☞ Ø 9.2 x 21.4 cm ☞ 50 ☞ Print Code: F(1), L1



Solara 20808

Jug. Stainless Steel. 450 ml.
Krug. Rostfreier Stahl. 450 ml.
Carafe. Acier Inox. 450 ml.
Kan. Roestvrij Staal. 450 ml.



DOUBLE WALL

450 ml

☞ Ø 9 × 12 cm ☞ 50 ☞ Print Code: F(1), L1



Tilton 6313

Mug. Ceramic. 700 ml.
Krug. Keramik. 700 ml.
Carafe. Céramique. 700 ml.
Kan. Keramiek. 700 ml.

700 ml

☞ Ø 10.3 × 13.8 cm ☞ 20 ☞ Print Code: F(4)



SPECIAL
● COFFEE SIZE

Lutin 5194

Mug. Ceramic. 80 ml.
Tasse. Keramik. 80 ml.
Tasse. Céramique. 80 ml.
Mok. Keramiek. 80 ml.

80 ml

☞ Ø 5.4 × 6.3 cm ☞ 72 ☞ Print Code: F(4)



New

Heim 20513

Sublimation Jug. Ceramic. 700 ml.
Sublimations Krug. Keramik. 700 ml.
Carafe Sublimation. Céramique. 700 ml.
Sublimatie Kan. Keramiek. 700 ml.

700 ml



☞ Ø 10.3 × 13.8 cm ☞ 20 ☞ Print Code: Q

New



Oxia 20510

Sublimation Jug. Glass. 500 ml.
Sublimations Krug. Glas. 500 ml.
Carafe Sublimation. Verre. 500 ml.
Sublimatie Kan. Glas. 500 ml.



500 ml

☞ Ø 8 × 15 cm ☞ 20 ☞ Print Code: L1, Q



Merzex 1254

Cup. Glass. 320 ml.
Trinkbecher. Glas. 320 ml.
Verre. Verre. 320 ml.
Beker. Glas. 320 ml.

320 ml

☞ Ø 7.3 × 9.6 cm ☞ 50 ☞ Print Code: F(1), L2

COASTER

Brunex 6005

Coaster: Cork.
 Untersetzer: Kork.
 Sous-Verre: Liège.
 Onderzetter: Kurk.

📏 Ø 10 x 0.3 cm 📦 2000 / 500 🖨️ Print Code: D(1), L1, W



4 PIECES



Yantic 6487

Coaster Set: Wood. 4 Pieces.
 Untersetzer Set: Holz. 4 Stück.
 Set Sous-Verre: Bois. 4 Pièces.
 Onderzetter Set: Hout. 4 Stuks.

📏 Ø 10 x 4 cm 📦 50 / 25 🖨️ Print Code: D(1), L1



UNIQUE PIECES FROM NATURAL CUTS OF WOOD.
 THE TEXTURE, COLOR, SIZES AND THICKNESS MAY VARY.

Sanly 1708

Coaster Set: Bamboo/ Felt RPET. 10 Pieces.
 Untersetzer Set: Bambus/ Filz RPET. 10 Stück.
 Set Sous-Verre: Bambou/ Feutrine RPET. 10 Pièces.
 Onderzetter Set: Bamboe/ Vilt RPET. 10 Stuks.

📏 10.7 x 6 x 10.7 cm 📦 50 🖨️ Print Code: D(1), E(1), L2, N(8)



Derrick 1749

Coaster: Bamboo.
 Untersetzer: Bambus.
 Sous-Verre: Bambou.
 Onderzetter: Bamboe.

📏 Ø 8.5 x 0.6 cm 📦 500 / 100
 🖨️ Print Code: D(1), L2, W



Palet 6275

Coaster: Wood.
 Untersetzer: Holz.
 Sous-Verre: Bois.
 Onderzetter: Hout.

📏 11.5 x 1.5 x 7.5 cm 📦 200 / 100 🖨️ Print Code: D(1), L1





Milty 4870

Apron. 100% Polyester.
Schürze. 100% Polyester.
Tablier. 100% Polyester.
Schort. 100% Polyester.

📏 54 x 30 cm 📦 200 / 25 🖨️ Print Code: F(1), N(8)



02

Nilson 4747

Chef Hat. TC. 35% Cotton/ 65% Polyester. Adjustable.
Kochmütze. TC. 35% Baumwolle/ 65% Polyester. Verstellbar.
Toque Cuisinier. TC. 35% Coton/ 65% Polyester. Ajustable.
Koksmuts. TC. 35% Katoen/ 65% Polyester. Aanpasbaar.

📏 Consult. 📦 250 / 50 🖨️ Print Code: E(1), N(8)



01



02

Garfy 9212

Bandana. Cotton/ Polyester.
Kopftuch. Baumwolle/ Polyester.
Bandana. Coton/ Polyester.
Bandana. Katoen/ Polyester.

📏 Consult. 📦 600 / 10 🖨️ Print Code: E(1), N(8), O



07

03



05

19



Vurcex 6295

Apron. 100% Cotton/ PU.
Schürze. 100% Baumwolle/ PU.
Tablier. 100% Coton/ Similicuir.
Schort. 100% Katoen/ PU.

68 x 80 cm 50
Print Code: G(4), N(8), P



ADJUSTABLE STRAPS



RPET



Yorrent 1714

Apron. 100% Cotton/ PU.
Schürze. 100% Baumwolle/ PU.
Tablier. 100% Coton/ Similicuir.
Schort. 100% Katoen/ PU.

68 x 90 cm 30 Print Code: G(4), N(8), P

Rober 6954

Apron. 100% Cotton.
Schürze. 100% Baumwolle.
Tablier. 100% Coton.
Schort. 100% Katoen.

68 x 80 cm 50 Print Code: G(4), N(8), P

Hanaku 1715

Apron. 100% Polyester RPET/ PU.
Schürze. 100% Polyester RPET/ PU.
Tablier. 100% Polyester RPET/ Similicuir.
Schort. 100% Polyester RPET/ PU.

70 x 95 cm 80/10 Print Code: F(1), N(8)



Yuzux 20807

6L

Bucket, Metal, 6 L, Opener Included.
Eimer, Metall, 6 L, Flaschenöffner Inklusiv.
Seau, Métal, 6 L, Ouvrir Bouteille Inclusive.
Emmer, Metaal, 6 L, Opener Inclusief.

📏 32 x 15 x 20.5 cm 📦 20 🗑️ Print Code: I(1)

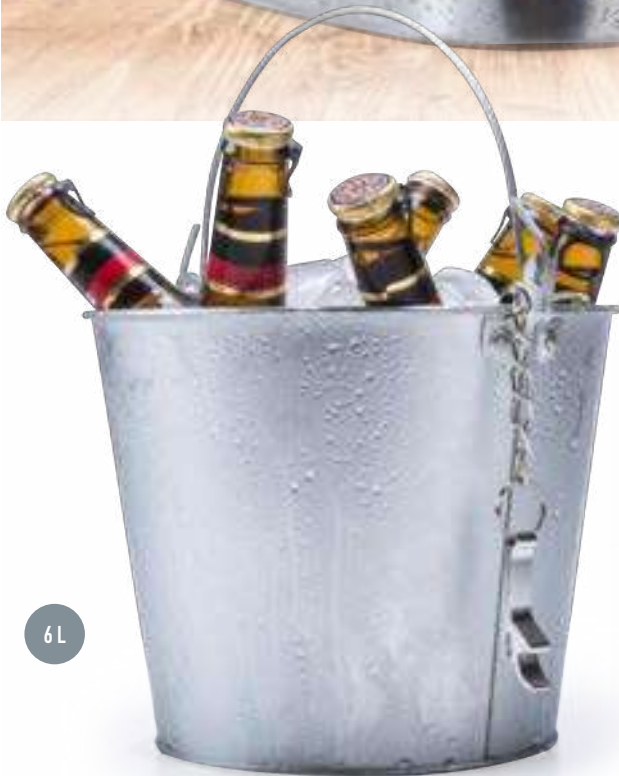

6L

Blake 5332

Bucket, Metal, 6 L, Opener Included.
Eimer, Metall, 6 L, Flaschenöffner Inklusiv.
Seau, Métal, 6 L, Ouvrir Bouteille Inclusive.
Emmer, Metaal, 6 L, Opener Inclusief.

📏 Ø 22.5 x 18.5 cm 📦 20 🗑️ Print Code: G(1)



01

04

03

19

Duken 1079

Bucket, Metal, 6 L, Opener Included.
Eimer, Metall, 6 L, Flaschenöffner Inklusiv.
Seau, Métal, 6 L, Ouvrir Bouteille Inclusive.
Emmer, Metaal, 6 L, Opener Inclusief.

📏 Ø 22.5 x 18.5 cm 📦 20 🗑️ Print Code: G(1)



02

6L

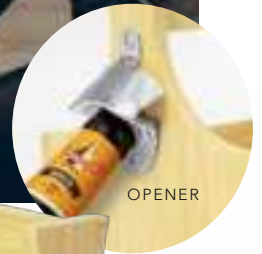

New



Aretha 20805

Ice Bucket, PS, 8 L.
Eiskübel, PS, 8 L.
Seau Glaçons, PS, 8 L.
Ijs Emmer, PS, 8 L.

35.8 × 25.3 × 25 cm 8 Print Code: I(1)



Voxen 20806

Bottle Holder, Bamboo, Opener Included.
Flaschenhalter, Bambus, Flaschenöffner inklusive.
Porte-Bouteilles, Bambou, Ouvre Bouteille Incluse.
Flessenhouder, Bamboe, Opener Inclusief.

28.9 × 24.7 × 17.9 cm 8
Print Code: I(1), L3

New

8.5 L

Larch 20128

Champagne Bucket. Stainless Steel. 8,5 L.
 Sektkühler. Rostfreier Stahl. 8,5 L.
 Seau à Champagne. Acier Inox. 8,5 L.
 Champagnekoeler. Roestvrij Staal. 8,5 L.

📏 Ø 35 × 22 cm 📦 4 🖨️ Print Code: I(1), L3



ELECTROPLATING COOPER COATING

Recubrimiento de cobre galvanizado



550 ml

Hamberly 1457

Cocktail Shaker. Stainless Steel. 550 ml.
 Shaker. Rostfreier Stahl. 550 ml.
 Shaker. Acier Inox. 550 ml.
 Shaker. Roestvrij Staal. 550 ml.

📏 Ø 8.6 × 21 cm 📦 50 🖨️ Print Code: F(1), L1

0.8 OZ
25ml**Corby 1456**

Jigger. Stainless Steel.
 Messbecher für Alkohol. Rostfreier Stahl.
 Mesureur de Boisson. Acier Inox.
 Jigger. Roestvrij Staal.

📏 Ø 4.5 × 11.5 cm 📦 200 / 50 🖨️ Print Code: F(1), L1

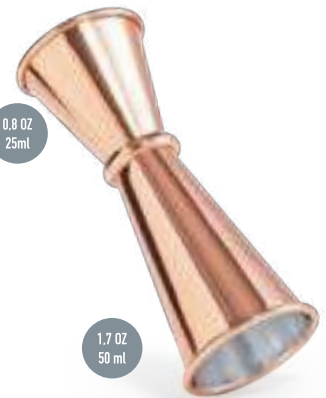
1.7 OZ
50 ml

LIMITED
edition
EXPERIENCE

649

BARWARE



Bespin 1349

Cocktail Set. Stainless Steel/ Wood. Cocktail Shaker 550 ml. 10 Accessories.
Cocktail Set. Rostfreier Stahl/ Holz. Shaker 550 ml. 10 Teile.
Set Cocktail. Acier Inox/ Bois. Shaker 550 ml. 10 Accessoires.
Cocktail Set. Roestvrij Staal/ Hout. Shaker 550 ml. 10 Accessoires.

28.5 x 33 x 10 cm 5 Print Code: F(1), H(1), L2



Relien 1615



Cocktail Set. Stainless Steel. Cocktail Shaker 550 ml. 4 Accessories.
Cocktail Set. Rostfreier Stahl. Shaker 550 ml. 4 Teile.
Set Cocktail. Acier Inox. Shaker 550 ml. 4 Accessoires.
Cocktail Set. Roestvrij Staal. Shaker 550 ml. 4 Accessoires.

30 x 9 x 28.5 cm 10 Print Code: F(1), L2



Roley 4843

Jigger. Stainless Steel.
Messbecher für Alkohol. Rostfreier Stahl.
Mesureur de Boisson. Acier Inox.
Jigger. Roestvrij Staal.

 Ø 3.9 x 6.5 cm  200 / 50
 Print Code: E(1), L1

1 OZ
30 ml0.5 OZ
15 ml

New

Zirano 20799

Jigger. Stainless Steel.
Messbecher für Alkohol. Rostfreier Stahl.
Mesureur de Boisson. Acier Inox.
Jigger. Roestvrij Staal.

 Ø 3.5 x 9 cm  200 / 50
 Print Code: E(1), L1



1.7 OZ
50 ml0.8 OZ
25 ml

New

New



Noro 20797

Straw Drink Stirrer. Stainless Steel.
Strohalm Drink Rührer. Rostfreier Stahl.
Agitateur Paille. Acier Inox.
Rietje Roerstaafje. Roestvrij Staal.

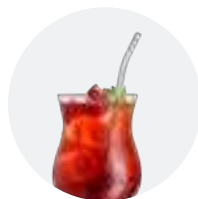
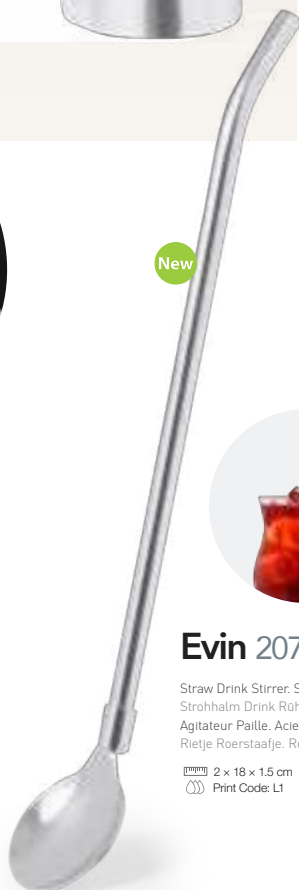
 3.2 x 22 x 1.8 cm  400 / 100
 Print Code: L1

**Evin 20798**

Straw Drink Stirrer. Stainless Steel.
Strohalm Drink Rührer. Rostfreier Stahl.
Agitateur Paille. Acier Inox.
Rietje Roerstaafje. Roestvrij Staal.

 2 x 18 x 1.5 cm  400 / 100
 Print Code: L1

**Micux 6479**

Drink Stirrer. Stainless Steel.
Drink Rührer. Rostfreier Stahl.
Agitateur. Acier Inox.
Roerstaafje. Roestvrij Staal.

 2.7 x 25.6 x 1.2 cm  400 / 50
 Print Code: L1





550 ml

Tobassy 5689

Cocktail Shaker. Stainless Steel. 550 ml.
Shaker. Rostfreier Stahl. 550 ml.
Shaker. Acier Inox. 550 ml.
Shaker. Roestvrij Staal. 550 ml.

📏 Ø 8.6 x 21 cm 📦 50 🏷️ Print Code: F(1), L1



New



Stiwar 20800

Cocktail Shaker. Stainless Steel. 500 ml.
Shaker. Rostfreier Stahl. 500 ml.
Shaker. Acier Inox. 500 ml.
Shaker. Roestvrij Staal. 500 ml.

📏 Ø 8.7 x 27 cm 📦 25 🏷️ Print Code: F(1), L1

500 ml



30 ml

Lolaf 1240

Shot Glass Tray. Bamboo/ Glass. 4 Pieces. 30 ml.
Shot-Tablett. Bambus/ Glas. 4 Stück. 30 ml.
Plateau de Shot. Bambou/ Verre. 4 Pièces. 30 ml.
Shot Dienblad. Bamboe/ Glas. 4 Stuks. 30 ml.

📏 33 x 8 x 6 cm 📦 20 🏷️ Print Code: E(1), L1





550 ml

New

1 OZ
30 ml0.5 OZ
15 ml

Hunton 20802

Cocktail Set. Bamboo/ Stainless Steel. Cocktail Shaker 550 ml. 9 Accessories.
 Cocktail Set. Bambus/ Rostfreier Stahl. Shaker 550 ml. 9 Teile.
 Set Cocktail. Bambou/ Acier Inox. Shaker 550 ml. 9 Accessoires.
 Cocktail Set. Bamboe/ Roestvrij Staal. Shaker 550 ml. 9 Accessoires.

28 × 26.5 × 10.5 cm 10 Print Code: H(1), L2



150 ml

New

550 ml

Cefiro 20801

Cocktail Set. Cocktail Shaker Stainless Steel 550 ml. 2 Glass 150 ml.
 Cocktail Set. Shaker Rostfreier Stahl 550 ml. 2 Glas 150 ml.
 Set Cocktail. Shaker Acier Inox 550 ml. 2 Verres 150 ml.
 Cocktail Set. Shaker Roestvrij Staal 550 ml. 2 Glas 150 ml.

37.5 × 9 × 27.5 cm 12 Print Code: F(1), L1



550 ml

1 OZ
30 ml0.5 OZ
15 ml

Wendol 1054

Cocktail Set. Stainless Steel. Cocktail Shaker 550 ml. 3 Accessories.
 Cocktail Set. Rostfreier Stahl. Shaker 550 ml. 3 Teile.
 Set Cocktail. Acier Inox. Shaker 550 ml. 3 Accessoires.
 Cocktail Set. Roestvrij Staal. Shaker 550 ml. 3 Accessoires.

13 × 21 × 9 cm 20 Print Code: F(1), L1



350 ml

Devon 1393

Whisky Set. Bamboe. Cup Glass 350 ml. 2 Ice Cubes Stainless Steel Reusable. Stainless Steel Tongs. Coaster Bamboo.

Whisky Set. Bamboe. Trinkbecher Glas 350 ml. 2 Eiswürfel Rostfreier Stahl Wiederverwendbar. Rostfreier Stahl Zange. Untersetzer Bamboe.

Set Whisky. Bamboe. Verre 350 ml. 2 Glaçons Acier Inox Réutilisables. Pincès Acier Inox. Sous-Verre Bamboe.

Whisky Set. Bamboe. Beker Glas 350 ml. 2 Ijsblokjes Rostvrij Staal Herbruikbaar. Rostvrij Staal Ijsblokjes-Tang. Onderzetter Bamboe.

20.8 x 14.5 x 10 cm 10 Print Code: F(1), L2



Steger 1706

Whisky Set. Bamboe. 2 Cups Glass 320 ml. 8 Ice Cubes Natural Stone Reusable. Stainless Steel Tongs. Cotton Pouch.

Whisky Set. Bamboe. 2 Trinkbecher Glas 320 ml. 8 Eiswürfel Naturstein Wiederverwendbar. Rostfreier Stahl Zange. Baumwolle Etui.

Set Whisky. Bamboe. 2 Verres 320 ml. 8 Glaçons Pierre Naturelle Réutilisables. Pincès Acier Inox. Etui Coton.

Whisky Set. Bamboe. 2 Beker Glas 320 ml. 8 Ijsblokjes Natuursteen Herbruikbaar. Rostvrij Staal Ijsblokjes-Tang. Katoen Zakje.

21.5 x 10.5 x 19.5 cm 8 Print Code: F(1), L2



320 ml



1L

200 ml

Rockwel 1705

Whisky Set. Glass. Decanter 1 L. 4 Cups 200 ml.

Whisky Set. Borosilikaat. Dekanter 1 L. 4 Trinkbecher Glas 200 ml.

Set Whisky. Verre. Décanteur 1 L. 4 Verres 200 ml.

Whisky Set. Glas. Decanteerder 1 L. 4 Beker 200 ml.

31 x 27 x 12 cm 8 Print Code: F(1), L2



Holier 6996

Set Stone Ice Cubes. Bamboo/ Natural Stone. Reusable. 9 Pieces. Stainless Steel Tongs and Cotton Pouch.
Eiswürfel Set. Bambus/ Naturstein. Wiederverwendbar. 9 Stück. Rostfreier Stahl Zange und Baumwolle Etui.
Set Glaçons. Bambou/ Pierre Naturelle. Réutilisable. 9 Pièces. Pincès Acier Inox et Étui Coton.
Ijsblokjes Set. Bamboe/ Natuursteen. Herbruikbaar. 9 Stuks. Roestvrij Staal Ijsblokjes-Tang en Katoen Zakje.

13.3 x 3.8 x 11.4 cm 30 Print Code: F(1), L2



Laniax 6995

Set Stone Ice Cubes. Natural Stone. Reusable. 4 Pieces. Cotton Pouch.
Eiswürfel Set. Naturstein. Wiederverwendbar. 4 Stück. Baumwolle Etui.
Set Glaçons. Pierre Naturelle. Réutilisable. 4 Pièces. Étui Coton.
Ijsblokjes Set. Natuursteen. Herbruikbaar. 4 Stuks. Katoen Zakje.

7.5 x 11 x 2 cm 100 / 50 Print Code: F(1), N(8)



Danny 20132

Set Stone Ice Cubes. Stainless Steel. Reusable. 4 Pieces.
Eiswürfel Set. Rostfreier Stahl. Wiederverwendbar. 4 Stück.
Set Glaçons. Acier Inox. Réutilisable. 4 Pièces.
Ijsblokjes Set. Roestvrij Staal. Herbruikbaar. 4 Stuks.

9.5 x 3.5 x 9 cm 50 / 25 Print Code: E(1)



Glamer 20131

Set Stone Ice Cubes. Granite. Reusable. 4 Pieces. Cotton Pouch.
Eiswürfel Set. Granit. Wiederverwendbar. 4 Stück. Baumwolle Etui.
Set Glaçons. Granit. Réutilisable. 4 Pièces. Étui Coton.
Ijsblokjes Set. Graniet. Herbruikbaar. 4 Stuks. Katoen Zakje.

10.5 x 15 x 2 cm 50 / 25 Print Code: F(1), N(8)



Rediston 1454

Hip Flask. Bamboo/ Stainless Steel. 170 ml.
 Flachmann. Bambus/ Rostfreier Stahl. 170 ml.
 Flacon. Bambou/ Acier Inox. 170 ml.
 Fles. Bamboe/ Roestvrij Staal. 170 ml.

9.3 x 11 x 2.2 cm
 Print Code: F(1)

50



170 ml



Groton 20795

Hip Flask. Cork/ Stainless Steel. 170 ml.
 Flachmann. Kork/ Rostfreier Stahl. 170 ml.
 Flacon. Liège/ Acier Inox. 170 ml.
 Fles. Kurk/ Roestvrij Staal. 170 ml.

9.5 x 11.5 x 2.4 cm
 Print Code: F(1), L2

100 / 50



170 ml



Zentia 20796

Hip Flask. Bamboo/ Stainless Steel. 45 ml.
 Flachmann. Bambus/ Rostfreier Stahl. 45 ml.
 Flacon. Bambou/ Acier Inox. 45 ml.
 Fles. Bamboe/ Roestvrij Staal. 45 ml.

Ø 2.2 x 16.2 cm
 Print Code: E(1), L1

200 / 100

45 ml



Maister 1660

Hip Flask. Stainless Steel. 150 ml.
 Flachmann. Rostfreier Stahl. 150 ml.
 Flacon. Acier Inox. 150 ml.
 Fles. Roestvrij Staal. 150 ml.

9 x 10.2 x 2.7 cm
 Print Code: F(1), L2

100 / 50



150 ml



Balton 20133

Hip Flask. Stainless Steel. 175 ml.
 Flachmann. Rostfreier Stahl. 175 ml.
 Flacon. Acier Inox. 175 ml.
 Fles. Roestvrij Staal. 175 ml.

9.3 x 11.2 x 2.1 cm
 Print Code: F(1), L2

100 / 50



175 ml



Deneb 21007

Hip Flask Keyring. Stainless Steel. 30 ml.
 Schlüsselanhänger Flachmann. Rostfreier Stahl. 30 ml.
 Porte-Clés Flacon. Acier Inox. 30 ml.
 Fles Sleutelhanger. Roestvrij Staal. 30 ml.

4.1 x 5.7 x 2 cm
 Print Code: D(4), L1

400 / 100

New

30 ml

Bottle Cooler

New



Gibli 20793

Bottle Cooler. Stainless Steel.
Flaschenkühler. Rostfreier Stahl.
Refrigidisseur Bouteilles. Acier Inox.
Flessenkoeler. Roestvrij Staal.

Ø 12 x 19.6 cm 20
Print Code: F(1), L2



Nohan 6991

Bottle Cooler. Stainless Steel.
Flaschenkühler. Rostfreier Stahl.
Refrigidisseur Bouteilles. Acier Inox.
Flessenkoeler. Roestvrij Staal.

Ø 11.9 x 18.8 cm 20
Print Code: F(1), L2



Vipal 6952

Bottle Cooler. Cork.
Flaschenkühler. Kork.
Refrigidisseur Bouteilles. Liège.
Flessenkoeler. Kurk.

34 x 18 cm 50 / 25
Print Code: E(1), L2



Raycon 4232

Bottle Cooler. PVC.
Flaschenkühler. PVC.
Refrigidisseur Bouteilles. PVC.
Flessenkoeler. Kurk.

10 x 25 x 10 cm 80 / 20
Print Code: F(1)

Bottle Cooler



08



20



21

02

03



06

02

08

Nuisant 9691

Bottle Cooler: PVC.
Flaschenkühler: PVC.
Refrigidisseur Bouteilles: PVC.
Flessenkoeler: PVC.

34 x 18 cm 50 / 25 Print Code: F(1)

Satish 1804

Bottle Cooler: PVC.
Flaschenkühler: PVC.
Refrigidisseur Bouteilles: PVC.
Flessenkoeler: PVC.

35 x 17 cm 40 / 20
Print Code: F(1)

Mahony 1659

Bottle Cooler: Nylon. Adjustable.
Flaschenkühler: Nylon. Verstellbar.
Refrigidisseur Bouteilles: Nylon. Ajustable.
Flessenkoeler: Nylon. Aanpasbaar.

15.5 x 22.5 x 1.4 cm 20 / 10
Print Code: F(1)

Boreas 20794

Bottle Cooler: Polyester. Adjustable.
Flaschenkühler: Polyester. Verstellbar.
Refrigidisseur Bouteilles: Polyester. Ajustable.
Flessenkoeler: Polyester. Aanpasbaar.

14 x 24 cm 50 / 25 Print Code: F(1)



Prescot 20130

Set. Glass. 4 Cups 500 ml. Decanter 1,8 L.
 Set. Glas. 4 Trinkbecher Glas 500 ml. Dekanter 1,8 L.
 Set. Verre. 4 Verres 500 ml. Décanteur 1,8 L.
 Set. Glas. 4 Beker 500 ml. Decanteerder 1,8 L.

30 × 20,2 × 25,5 cm 4 Print Code: G(1), L2



LIMITED
edition
 EXPERIENCE



Colley 1348

Wine Decanter. Borosilicate Glass/ Wood. 1,7 L.
 Wein Dekanter. Borosilikat Glas/ Holz. 1,7 L.
 Décanteur. Verre Borosilicate/ Bois. 1,7 L.
 Decanteerder. Borosilicate Glas/ Hout. 1,7 L.

16,9 × 29 × 16,9 cm 6 Print Code: F(1), H(1), L2

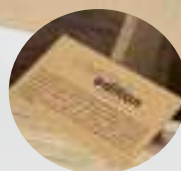

Seirten 1280

Wine Decanter. Borosilicate Glass/ Cork. 1,7 L.
 Wein Dekanter. Borosilikat Glas/ Kork. 1,7 L.
 Décanteur. Verre Borosilicate/ Liège. 1,7 L.
 Decanteerder. Borosilicate Glas/ Kurk. 1,7 L.

Ø 14 × 25 cm 20 Print Code: G(1), L2



Pikerson 6599

Wine Decanter. Glass. 1,8 L.
 Wein Dekanter. Glas. 1,8 L.
 Décanteur. Verre. 1,8 L.
 Decanteerder. Glas. 1,8 L.

Ø 20 × 28 cm 6
 Print Code: G(1), L2



Magnar 20791

Wine Set. 4 Accessories.
Wein Set. 4 Teile.
Set Vin. 4 Accessoires.
Wijn Set. 4 Accessoires.

 13.5 x 23 x 6.8 cm  25  Print Code: F(1), L2



New



Deyong 1656

Electric Corkscrew. Stainless Steel/ ABS. 4 Batteries AA Not Included.
Elektrischer Korkenzieher. Rostfreier Stahl/ ABS. 4 AA Batterien Nicht im Lieferumfang.
Tire-Bouchon Électrique. Acier Inox/ ABS. 4 Piles AA Non Incluses.
Elektrische Kurkretrekker. Roestvrij Staal/ ABS. 4 Batterijen AA Niet Inclusief.

 Ø 4.5 x 23.4 cm  30  Print Code: L2

AIR
PUMP

Parples 20790

Corkscrew.
Korkenzieher.
Tire-Bouchon.
Kurkretrekker.

 Ø 4.5 x 19.5 cm  100 / 25  Print Code: E(1)

AIR
PUMP

Greymuz 1460

Corkscrew.
Korkenzieher.
Tire-Bouchon.
Kurkretrekker.

 Ø 2.1 x 21 cm  100 / 50  Print Code: E(1)



Wine Accessories



Filden 1946

Cap. Wood.
Deckel. Holz.
Bouchon. Bois.
Stop. Hout.

📏 Ø 2.9 x 3.3 cm 📦 1000 / 250 🗑️ Print Code: C(4), L1



Otto 20789

Drip Stop Ring. Stainless Steel.
Tropfring. Rostfreier Stahl.
Anti-Gouttes. Acier Inox.
Druppelvanger. Roestvrij Staal.

📏 Ø 4 x 1.8 cm 📦 1000 / 50 🗑️ Print Code: L1



Kabalt 6096

Vacuum Bottle Stopper. AS/ TPR.
Deckel Vakuumpumpe. AS/ TPR.
Bec Pompe à Vide. AS/ TPR.
Stop Vacuum Pomp. AS/ TPR.

📏 Ø 2.8 x 8.2 cm 📦 300 / 50 🗑️ Print Code: D(1)



Hoxmar 6097

Vacuum Bottle Stopper. ABS.
Deckel Vakuumpumpe. ABS.
Bec Pompe à Vide. ABS.
Stop Vacuum Pomp. ABS.

📏 Ø 4.6 x 7.2 cm 📦 200 / 50 🏷️ Print Code: C(4)



Crianz 4975

Wine Aerator. Acrylic.
Wein Belüfter. Acryl.
Aérateur Vin. Acrylique.
Decanteer Wijnschenker. Acryl.

📏 Ø 2.2 x 16.2 cm 📦 200 / 50 🏷️ Print Code: D(1)

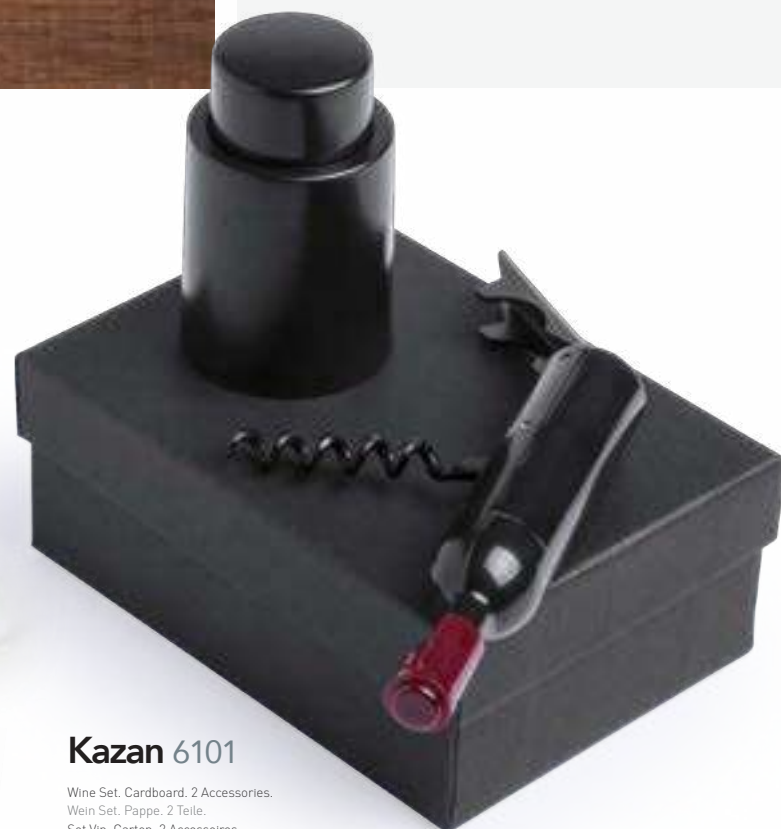

Kazan 6101

Wine Set. Cardboard. 2 Accessories.
Wein Set. Pappe. 2 Teile.
Set Vin. Carton. 2 Accessoires.
Wijn Set. Karton. 2 Accessoires.

📏 9.7 x 5.3 x 13.6 cm 📦 50 🏷️ Print Code: E(1)



Klein 1274

Bottle Holder. Wood. Foldable.
Flaschenhalter. Holz. Faltbar.
Porte-Bouteilles. Bois. Pliable.
Flessenhouder. Hout. Opvouwbaar.

13 x 46.5 x 2 cm 20 Print Code: E(1), L1

1L 2233

Wineskin. Leather. Food Grade Certified.
Weinschlauch. Leder. Für die Verwendung für
Lebensmitteln zugelassen.
Gourde à Vin. Cuir. Homologué pour Usage Alimentaire.
Lapzak. Leer. Voor Voedselgebruik Gecertificeerd.
 16.7 x 30 cm 100 Print Code: E(1)



Hiblux 6994

Wine and Cheese Knife Set. Bamboo. 4 Accessories.
Wein und Käse Set. Bambus. 4 Teile.
Set Vin et Fromages. Bambou. 4 Accessoires.
Wijn en Kaas Set. Bamboe. 4 Accessoires.

25 x 3.6 x 19 cm 10 Print Code: F(1), L2



Noarek 6993

Wine Set. Cardboard. 3 Accessories.
 Wein Set. Pappe. 3 Teile.
 Set Vin. Carton. 3 Accessoires.
 Wijn Set. Karton. 3 Accessoires.

16.5 x 3.6 x 10.1 cm 50 Print Code: E(1)

LIMITED
edition
 EXPERIENCE

663

BARWARE



Zerquen 1616

Wine Set. Stainless Steel. 3 Accessories.
 Wein Set. Rostfreier Stahl. 3 Teile.
 Set Vin. Acier Inox. 3 Accessoires.
 Wijn Set. Roestvrij Staal. 3 Accessoires.

16.5 x 4.5 x 13 cm 80 Print Code: F(1), L2

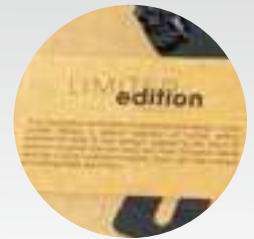

Sousky 5840

Wine Set. ABS. 3 Accessories.
 Wein Set. ABS. 3 Teile.
 Set Vin. ABS. 3 Accessoires.
 Wijn Set. ABS. 3 Accessoires.

Ø 6.4 x 24 cm 20 / 10 Print Code: E(1)



Sarap 3783

Wine Set. ABS. 3 Accessories.
 Wein Set. ABS. 3 Teile.
 Set Vin. ABS. 3 Accessoires.
 Wijn Set. ABS. 3 Accessoires.

Ø 6 x 24 cm 20 / 10 Print Code: E(1)

02



03



New

Paluk 21099

Wine Set. Bamboo. 4 Accessories.
Wein Set. Bambus. 4 Teile.
Set Vin. Bambou. 4 Accessoires.
Wijn Set. Bamboe. 4 Accessoires.

14,8 x 5,2 x 16,8 cm 20
 Print Code: F(1), L2



Darini 20786

Wine Set. Bamboo. 4 Accessories.
Wein Set. Bambus. 4 Teile.
Set Vin. Bambou. 4 Accessoires.
Wijn Set. Bamboe. 4 Accessoires.

29 x 3,4 x 9,9 cm 20 Print Code: F(1), L2



350 ml

Neider 1707

Wine Set. Bamboo. 2 Wine Glass 350 ml.
Corkscrew Opener Stainless Steel.
Wein Set. Bambus. 2 Weinglas 350 ml.
Korkenzieher Flaschenöffner Rostfreier Stahl.
Set Vin. Bamboe. 2 Verres à Vin 350 ml. Tire-
Bouchon Ouvre Boutelle Acier Inox.
Wijn Set. Bamboe. 2 Wijnglas 350 ml.
Korktrekker Opener Roestvrij Staal.
 21,9 x 24 x 10,8 cm 8
 Print Code: F(1), L2



New



WineSet



Nitel 6099

Wine Set. Bamboo. 3 Accessoires.
 Wein Set. Bambus. 3 Teile.
 Set Vin. Bambou. 3 Accessoires.
 Wijn Set. Bamboe. 3 Accessoires.

 16 x 4,9 x 10 cm  20  Print Code: F(1), L2

Boriach 6100

Wine Set. Bamboo. 4 Accessoires.
 Wein Set. Bambus. 4 Teile.
 Set Vin. Bambou. 4 Accessoires.
 Wijn Set. Bamboe. 4 Accessoires.

 36 x 12 x 11 cm  10  Print Code: F(1), L2



Wine Set



New



Baco 9648

Wine Set. Wood. 5 Accessories.
Wein Set. Holz. 5 Teile.
Set Vin. Bois. 5 Accessoires.
Wijn Set. Hout. 5 Accessoires.

📏 Ø 17 x 3.5 cm 📦 20 🖨️ Print Code: F(1), L2



Albion 20787

Wine Set. PU. 4 Accessories.
Wein Set. PU. 4 Teile.
Set Vin. Similicuir. 4 Accessoires.
Wijn Set. PU. 4 Accessoires.

📏 Ø 15 x 4 cm 📦 20 🖨️ Print Code: F(1)



Wiset



Bribal 6098

Wine Set. Cork. 4 Accessories.
Wein Set. Kork. 4 Teile.
Set Vin. Liège. 4 Accessoires.
Wijn Set. Kurk. 4 Accessoires.

📏 15 x 4 cm 📦 20 🗑️ Print Code: F(1), L2



Maquin 21060

Wine Set. Cork. 2 Accessories.
Wein Set. Kork. 2 Teile.
Set Vin. Liège. 2 Accessoires.
Wijn Set. Kurk. 2 Accessoires.

📏 14.9 x 4 x 9.3 cm 📦 30 🗑️ Print Code: F(1), L2





18

Varien 4774

Bag. Non-Woven.
Tasche. Non-Woven.
Sac. T.N.T.
Tas. Non-Woven.



20

02

06

16 x 40 x 6.5 cm 1000 / 50 Print Code: F(1)

Ragnar 5487

Bag. Recycled Paper 100 g/ m².
Tasche. Recycling Papier 100 g/ m².
Sac. Papier Recyclé 100 g/ m².
Tas. Gerecycled Papier 100 g/ m².



11 x 36 x 10 cm 500 / 100 Print Code: F(1)

Holden 3480

Bag. Laminated Jute.
Tasche. Laminiertes Jutestoff.
Sac. Jute Laminé.
Tas. Gelamineerd Jute.



10.5 x 35.5 x 10 cm 150 / 25 Print Code: G(1), N(8)

Koop 3481

Bag. Laminated Jute.
Tasche. Laminiertes Jutestoff.
Sac. Jute Laminé.
Tas. Gelamineerd Jute.



20 x 34.5 x 10 cm 100 / 25 Print Code: G(1), N(8)

Minax 6953

Bag. Cork.
Tasche. Kork.
Sac. Liège.
Tas. Kurk.



10 x 33 x 10 cm 200 / 25 Print Code: F(1), N(8)

Yaiza 6990

Bag. Canvas 220 g/ m².
Tasche. Canvas 220 g/ m².
Sac. Canvas 220 g/ m².
Tas. Canvas 220 g/ m².



8 x 31 x 8 cm 200 / 20 Print Code: F(1), N(8)



Dorkus 1666

Gift Box. Wood.
Geschenk-Box. Holz.
Boîte de Présentation. Bois.
Geschenkendoos. Hout.

34.7 x 11.2 x 28.5 cm 5
 Print Code: F(1), L2



Grimbur 1943

Gift Box. Wood.
Geschenk-Box. Holz.
Boîte de Présentation. Bois.
Geschenkendoos. Hout.

10 x 35 x 10 cm 15 Print Code: F(1), L2



Plesnik 1652

Bag. Polyester.
Tasche. Polyester.
Sac. Polyester.
Tas. Polyester.

Ø 8 x 34 cm 500 / 10 Print Code: F(1), N(8)



Drazen 1651

Bag. 100% Coton Organique/ Cork.
Tasche. 100% Organische Baumwolle/ Kork.
Sac. 100% Coton Organique/ Liège.
Tas. 100% Organisch Katoen/ Kurk.

Ø 8 x 34 cm 400 / 10 Print Code: F(1), N(8)



Majan 20785

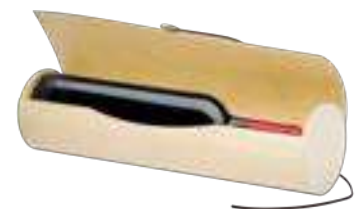

Gift Box. Wood.
Geschenk-Box. Holz.
Boîte de Présentation. Bois.
Geschenkendoos. Hout.

Ø 8 x 34 cm 30 Print Code: E(1)



Garet 6504

Comb. Bamboo.
Kamm. Bambus.
Peigne. Bambou.
Kam. Bamboe.

 3.1 x 18.7 x 0.5 cm  500 / 100
 Print Code: C(4), L1





Garet 6504

Wofel 6503

Wofel 6503

Comb. Wheat Straw/ PP.
Kamm. Weizenstroh/ PP.
Peigne. Paille de Blé/ PP.
Kam. Tarwestro/ PP.



 2.8 x 17 x 0.3 cm  1000 / 50
 Print Code: C(4)



Special Hotel

**Lencix 6362**

Toothbrush. Bamboo.
Zahnbürste. Bambus.
Brosse à Dents. Bambou.
Tandenborstel. Bamboe.

 1.3 x 17.5 x 1.6 cm  500 / 50
 Print Code: C(4), L1





Lencix 6362

Cleldol 6278

Cleldol 6278

Toothbrush. Wheat Straw/ PP.
Zahnbürste. Weizenstroh/ PP.
Brosse à Dents. Paille de Blé/ PP.
Tandenborstel. Tarwestro/ PP.

 1.2 x 18 x 1.6 cm  500 / 50
 Print Code: C(4)

**Duncan 1639**

Toothbrush. Wheat Straw/ PP. Foldable.
Zahnbürste. Weizenstroh/ PP. Faltbar.
Brosse à Dents. Paille de Blé/ PP. Pliable.
Tandenborstel. Tarwestro/ PP. Opvouwbaar.

 1.6 x 16.2 x 2.3 cm  500 / 50
 Print Code: C(4), W

**Dantel 6557**

Hairbrush. Wheat Straw/ PP.
Bürste. Weizenstroh/ PP.
Brosse. Paille de Blé/ PP.
Haarborstel. Tarwestro/ PP.

 5 x 17.3 x 3.4 cm  200 / 20
 Print Code: D(4)



Flugax 20821

01

Slippers. Non-Woven. Anti-Slip. One Size 36-43.
 Pantoffeln. Non-Woven. Rutschfest. Einheitsgrösse 36-43.
 Pantoufles. T.N.T. Antidérapant. Taille Unique 36-43.
 Slippers. Non-Woven. Anti-Slip. Eén Maat 36-43.

Consult. 200 Print Code: E(1)



08



06



01

Tarkun 6501

Slippers. Cotton/ Polyester. Anti-Slip. One Size 36-43.
 Pantoffeln. Baumwolle/ Polyester. Rutschfest. Einheitsgrösse 36-43.
 Pantoufles. Coton/ Polyester. Antidérapant. Taille Unique 36-43.
 Slippers. Katoen/ Polyester. Anti-Slip. Eén Maat 36-43.

Consult. 200 / 10 Print Code: E(1), N(8), R



02



Nalton 6502

Slippers. Cotton/ Polyester. Anti-Slip. One Size 36-43.
 Pantoffeln. Baumwolle/ Polyester. Rutschfest. Einheitsgrösse 36-43.
 Pantoufles. Coton/ Polyester. Antidérapant. Taille Unique 36-43.
 Slippers. Katoen/ Polyester. Anti-Slip. Eén Maat 36-43.

Consult. 200 / 10 Print Code: E(1), N(8)



Kaicel 1661

Slippers. Felt RPET. Anti-Slip. One Size 36-43.
 Pantoffeln. Filz RPET. Rutschfest. Einheitsgrösse 36-43.
 Pantoufles. Feutrine RPET. Antidérapant. Taille Unique 36-43.
 Slippers. Vilt RPET. Anti-Slip. Eén Maat 36-43.

Consult. 200 / 10 Print Code: E(1), N(8)

RPET

EAU DE TOILETTE

20 ml

WOMAN



Made in Europe

Stedlers 2718

Eau de Toilette for Women. 20 ml. Refillable.
 Eau de Toilette für Frauen. 20 ml. Wiederaufladbar.
 Eau de Toilette pour Femme. 20 ml. Rechargeable.
 Eau de Toilette voor Vrouwen. 20 ml. Navulbaar.

Ø 2.5 x 10.5 cm 100 Print Code: E(1)

20 ml

MAN



Made in Europe

Dauson 2717

Eau de Toilette for Men. 20 ml. Refillable.
 Eau de Toilette für Männer. 20 ml. Wiederaufladbar.
 Eau de Toilette pour Homme. 20 ml. Rechargeable.
 Eau de Toilette voor Mannen. 20 ml. Navulbaar.

Ø 2.5 x 10.5 cm 100 Print Code: E(1)



Essential Kit 1643

Set. Comb Wheat Straw/ PP. Toothbrush Wheat Straw/ PP.
 Toothpaste 6 gr. Bar Soap 20 gr.
 Set. Kamm Weizenstroh/ PP. Zahnbürste Weizenstroh/ PP.
 Zahnpasta 6 gr. Seifenstück 20 gr.
 Set. Peigne Paille de Blé/ PP. Brosse à Dents Paille de Blé/ PP.
 Dentifrice 6 gr. Savon 20 gr.
 Set. Kam Tarwestro/ PP. Tandborstel Tarwestro/ PP. Tandpasta
 6 gr. Stuk Zeep 20 gr.

14.5 x 2.5 x 4.7 cm 200 / 50 Print Code: C(1), B(4)



Shaving Kit 1642

Set. Razor Blade Wheat Straw/ PP. Shaving Gel 8 gr.
 Set. Rasierklinge Weizenstroh/ PP. Rasiergel 8 gr.
 Set. Lame de rasoir Paille de Blé/ PP. Gel de rasage 8 gr.
 Set. Scheermes Tarwestro/ PP. Scheergel 8 gr.

10.5 x 2.5 x 4.5 cm 300 / 50 Print Code: C(1), B(4)



Dental Kit 1641

Set. Toothbrush Wheat Straw/ PP. Toothpaste 6 gr.
 Set. Zahnbürste Weizenstroh/ PP. Zahnpasta 6 gr.
 Set. Brosse à Dents Paille de Blé/ PP. Dentifrice 6 gr.
 Set. Tandborstel Tarwestro/ PP. Tandpasta 6 gr.

14 x 1.5 x 2.5 cm 300 / 50 Print Code: C(1), B(4)



! +10.000 uds
PRINTING 12% Dto.

Miniature 9607 SHARPENED

Pencil. Wood.
Bleistift. Holz.
Crayon. Bois.
Potlood. Hout.

▮ Ø 0,5 × 10 cm 📦 2000 / 100
🖨️ Print Code: A(4), L1

New



! +10.000 uds
PRINTING 12% Dto.

Vexor 20681 SHARPENED

Pencil. Wood.
Bleistift. Holz.
Crayon. Bois.
Potlood. Hout.

▮ Ø 0,7 × 10 cm 📦 2000 / 100
🖨️ Print Code: A(1), L1



Krako 1933 SHARPENED

Pencil. Wood.
Bleistift. Holz.
Crayon. Bois.
Potlood. Hout.

▮ Ø 0,7 × 17,5 cm 📦 2000 / 100
🖨️ Print Code: A(1), L1

! +10.000 uds
PRINTING 12% Dto.

Nexio 1934 SHARPENED

Pencil. Wood.
Bleistift. Holz.
Crayon. Bois.
Potlood. Hout.

▮ Ø 0,7 × 19 cm 📦 2000 / 100
🖨️ Print Code: A(1), L1

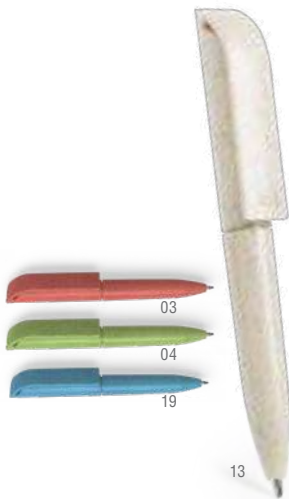

Radun 6567

Mini Pen. Wheat Straw/ ABS.
Mini Kugelschreiber. Weizenstroh/ ABS.
Mini Stylo. Paille de Blé/ ABS.
Minipen. Tarwestro/ ABS.

▮ Ø 1 × 9,2 cm 📦 2000 / 50
🖨️ Print Code: A(4), W



Hall 3147

Mini Pen.
Mini Kugelschreiber.
Mini Stylo.
Minipen.

▮ Ø 1 × 9,6 cm 📦 2000 / 100
🖨️ Print Code: A(4), W



! +10.000 uds
PRINTING 12% Dto.

Wipper 6605

Pen. Wheat Straw/ ABS.
Kugelschreiber. Weizenstroh/ ABS.
Stylo. Paille de Blé/ ABS.
Pen. Tarwestro/ ABS.

▮ Ø 1 × 13,8 cm 📦 1000 / 50
🖨️ Print Code: A(4)



Ricen 1671

Pen. Gel Ink.
Kugelschreiber. Gel Tinte.
Stylo. Encre Gel.
Pen. Gel Inkt.

▮ Ø 1 × 14,8 cm 📦 1000 / 50
🖨️ Print Code: A(4)

17 GIFTS & PREMIUMS





**INSPIRE,
GIVE,
SURPRISE**



Vesper 20606



Photo Frame. MDF. Photos Size: 13,5 x 9 cm.
Bilderrahmen. MDF. Photos: 13,5 x 9 cm.
Porte Photos. MDF. Photos: 13,5 x 9 cm.
Fotolijst. MDF. Foto's Maat: 13,5 x 9 cm.

15 x 22 x 15 cm 8 Print Code: F(1), L2

New

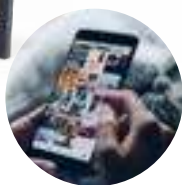

COMPATIBLE WITH
ANDROID & iOS



Picty 21017

Digital Photo Frame. 10,1". Wifi, 1280x800 IPS. AC 220-240V.
Digitaler Photoramen. 10,1". Wifi, 1280x800 IPS. AC 220-240V.
Cadre Photos Digitales. 10,1". Wifi, 1280x800 IPS. AC 220-240V.
Digitale Fotolijst. 10,1". Wifi, 1280x800 IPS. AC 220-240V.

26.4 x 18.4 x 2.2 cm 10 Print Code: G(1)



New



Oleox 20978

Art Frame. MDF.
Kunstrahmen. MDF.
Cadre d'art. MDF.
Kunstlijst. MDF.

24 x 33 x 3 cm 20 Print Code: F(1), L2





Furgon 20989

Model. Metal.
Modell. Metall.
Maquette. Métal.
Model. Metaal.

7.6 x 4 x 4 cm 100 Print Code: D(1), L1



Vespak 20990

Model. Metal.
Modell. Metall.
Maquette. Métal.
Model. Metaal.

11 x 8 x 4 cm 50 Print Code: D(1)



Truck 20991

Model. ABS.
Modell. ABS.
Maquette. ABS.
Model. ABS.

19.5 x 3 x 3 cm 100 Print Code: D(1), W



Cohep 20988

Model. Metal.
Modell. Metall.
Maquette. Métal.
Model. Metaal.

8 x 4 x 4 cm 100 Print Code: D(1), L1



Reylox 1916

Card Holder. Cork. RFID Protected. 6 Compartments.
 Visitenkartenetui. Kork. RFID Schutz. 6 Abteilungen.
 Porte-Cartes. Liège. Protecteur RFID. 6 Compartiments.
 Kaartjeshouder. Kurk. RFID Bescherming. 6 Compartimenten.

10.5 x 8.5 x 0.5 cm 500 / 50 Print Code: D(1), L1



Buguet 1904

Card Holder. Wheat Straw/ ABS. RFID Protected. 1 Compartment.
 Visitenkartenetui. Weizenstroh/ ABS. RFID Schutz. 1 Abteilung.
 Porte-Cartes. Paille de Blé/ ABS. Protecteur RFID. 1 Compartiment.
 Kaartjeshouder. Tarwestro/ ABS. RFID Bescherming. 1 Compartment.

6 x 9 x 0.4 cm 1000 / 100 Print Code: D(4), W



Faxol 1905

Card Holder. Wheat Straw/ ABS. RFID Protected. 1 Compartment.
 Visitenkartenetui. Weizenstroh/ ABS. RFID Schutz. 1 Abteilung.
 Porte-Cartes. Paille de Blé/ ABS. Protecteur RFID. 1 Compartiment.
 Kaartjeshouder. Tarwestro/ ABS. RFID Bescherming. 1 Compartment.

6.2 x 10 x 1.1 cm 500 / 50 Print Code: D(4), W



Becam 5637

Card Holder. Aluminium. RFID Protected. 1 Compartment.
 Visitenkartenetui. Aluminium. RFID Schutz. 1 Abteilung.
 Porte-Cartes. Aluminium. Protecteur RFID. 1 Compartiment.
 Kaartjeshouder. Aluminium. RFID Bescherming. 1 Compartment.

6.2 x 9 cm 5000 / 100 Print Code: B(1)



Habirok 1903

Card Holder. Felt RPET. 1 Compartment.
 Visitenkartenetui. Filz RPET. 1 Abteilung.
 Porte-Cartes. Feutrine RPET. 1 Compartment.
 Kaartjeshouder. Vilt RPET. 1 Compartment.

6.5 x 9 cm 1000 / 50 Print Code: D(1), N(8)



Blakbal 1463

Card Holder. Recycled Paper/ Aluminium. RFID Protected. 1 Compartment.
 Visitenkartenetui. Recycling Papier/ Aluminium. RFID Schutz. 1 Abteilung.
 Porte-Cartes. Papier Recyclé/ Aluminium. Protecteur RFID. 1 Compartment.
 Kaartjeshouder. Gerecycled Papier/ Aluminium. RFID Bescherming. 1 Compartment.

6.2 x 9 cm 5000 / 100 Print Code: B(1)



06



02



08

Copek 1895

Card Holder. Polyester RPET. 3 Compartments.
 Visitenkartenetui. Polyester RPET. 3 Abteilungen.
 Porte-Cartes. Polyester RPET. 3 Compartiments.
 Kaartjeshouder. Polyester RPET. 3 Compartimenten.

10.6 x 7.6 x 0.3 cm 600 / 100 Print Code: D(1), N(8)



RFID PROTECTION

Kenxo 1901

Card Holder Wallet. Polyester RPET. RFID Protected. 6 Compartments.
 Visitenkartenetui Brieftasche. Polyester RPET. RFID Schutz. 6 Abteilungen.
 Porte-Cartes Portefeuille. Polyester RPET. Protecteur RFID. 6 Compartiments.
 Kaartjeshouder Portemonnee. Polyester RPET. RFID Bescherming. 6 Compartimenten.

11 x 8.6 x 1.3 cm 200 / 50 Print Code: D(1), N(8)



Guarex 1902

Card Holder. Polyester RPET. RFID Protected. 5 Compartments.
 Visitenkartenetui. Polyester RPET. RFID Schutz. 5 Abteilungen.
 Porte-Cartes. Polyester RPET. Protecteur RFID. 5 Compartiments.
 Kaartjeshouder. Polyester RPET. RFID Bescherming. 5 Compartimenten.

7.2 x 10.5 x 0.9 cm 500 / 250 Print Code: D(1), N(8)



New

Eltanin 20992

Card Holder. Metal/ Bamboo. 1 Compartment.
 Visitenkartenetui. Metal/ Bambus. 1 Abteilung.
 Porte-Cartes. Métal/ Bambou. 1 Compartiment.
 Kaartjeshouder. Metaal/ Bamboe. 1 Compartment.

9.4 x 5.9 x 1 cm 200 / 50
 Print Code: D(1), L1, W



06

02

08

Restek 1894

Card Holder. Polyester RPET. 1 Compartment.
 Visitenkartenetui. Polyester RPET. 1 Abteilung.
 Porte-Cartes. Polyester RPET. 1 Compartiment.
 Kaartjeshouder. Polyester RPET. 1 Compartment.

9.5 x 6.4 x 1.3 cm 200 / 50 Print Code: D(1), L1, N(8)

RFID PROTECTION



09

Brigit 5221

Card Holder. PU. RFID Protected. 8 Compartments.
Visitenkartenetui. PU. RFID Schutz. 8 Abteilungen.
Porte-Cartes. Similicuir. Protecteur RFID. 8 Compartiments.
Kaartjeshouder. PU. RFID Bescherming. 8 Compartimenten.

8.2 x 11.7 x 1.5 cm 200 / 50 Print Code: D(1), T



Rainol 5371

Card Holder. Aluminium. RFID Protected. 6 Compartments.
Visitenkartenetui. Aluminium. RFID Schutz. 6 Abteilungen.
Porte-Cartes. Aluminium. Protecteur RFID. 6 Compartiments.
Kaartjeshouder. Aluminium. RFID Bescherming. 6 Compartimenten.

11 x 7.5 x 2 cm 200 / 50 Print Code: D(4), L1



03



19



04



02



Mercel 1898

Card Holder. Felt RPET. 6 Compartments.
Visitenkartenetui. Filz RPET. 6 Abteilungen.
Porte-Cartes. Feutrine RPET. 6 Compartiments.
Kaartjeshouder. Vilt RPET. 6 Compartimenten.

11 x 8 x 1.5 cm 500 / 50 Print Code: D(1), N(8)



Aquilax 1028

Wallet. Cork.
Brieftasche. Kork.
Portefeuille. Liège.
Portemonnee. Kurk.

10 x 7.5 x 2 cm 300 / 10 Print Code: D(1), L1, N(8)



Dabey 5881

Purse. Cork. With Inner Lining.
Portemonnaie. Kork. Mit Innenfutter.
Porte Monnaie. Liège. Avec Doublure Intérieure.
Portemonnee. Kurk. Met Voering aan de Binnenzijde.

10 x 9 x 2 cm 500 / 10 Print Code: D(1), L1





Gagox 1897

Purse. Felt RPET.
Portemonnaie. Filz RPET.
Porte Monnaie. Feutrine RPET.
Portemonnee. Vilt RPET.

10.5 × 8 × 0.5 cm 500 / 50 Print Code: D(1), N(8)

Nelsom 6843

Purse. Polyester 600D RPET.
Portemonnaie. Polyester 600D RPET.
Porte Monnaie. Polyester 600D RPET.
Portemonnee. Polyester 600D RPET.

10.5 × 8 × 0.5 cm 1000 / 20 Print Code: D(1), N(8)

Fontix 1917

Purse. 100% Recycled Cotton.
Portemonnaie. 100% Recycling Baumwolle.
Porte Monnaie. 100% Coton Recyclé.
Portemonnee. 100% Gerecycled Katoen.

10.5 × 8 × 0.5 cm 1000 / 50 Print Code: D(1), N(8)



Zarynix 21073

Purse. Canvas.
Portemonnaie. Canvas.
Porte Monnaie. Toile.
Portemonnee. Canvas.

10 × 10 × 10 cm 1000 / 100
Print Code: D(1), N(8)

Meyvin 21072

Purse. Polyester 600D.
Portemonnaie. Polyester 600D.
Porte Monnaie. Polyester 600D.
Portemonnee. Polyester 600D.

7.5 × 11 × 4.5 cm 800 / 100
Print Code: D(1), N(8)





22



Faudok 5934

Purse. PU.
Portemonnaie. PU.
Porte Monnaie. Similicuir.
Portemonnee. PU.



09

12 x 8.5 x 0.5 cm 1000 / 10 Print Code: D(1)

Narse 6475

Purse. Cotton/ Polyester.
Portemonnaie. Baumwolle/ Polyester.
Porte Monnaie. Coton/ Polyester.
Portemonnee. Katoen/ Polyester.

11 x 8.5 x 2 cm 1000 / 10 Print Code: E(1), N(8)



Ralf 5096

Purse. PU.
Portemonnaie. PU.
Porte Monnaie. Similicuir.
Portemonnee. PU.

10.5 x 9 x 0.8 cm 500 / 10 Print Code: L1



Dramix 5095

Purse. PU.
Portemonnaie. PU.
Porte Monnaie. Similicuir.
Portemonnee. PU.

10.5 x 7.5 x 0.5 cm 1000 / 20 Print Code: D(1), L1



Kely 21171

Earrings. Acrylic.
 Ohringe. Acryl.
 Boucles d'Oreille. Acrylique.
 Oorbellen. Acryl.

Consult. 500 / 10
 Print Code: C(1)

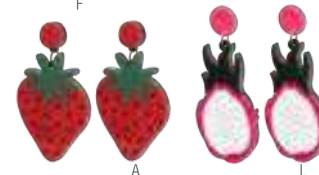

New



Azix 20527

Jewellery Wrap. Cotton.
 Schmuckbox. Baumwolle.
 Etui Bijoux. Coton.
 Sieradendoosje. Katoen.

30 x 18 cm 200 / 10 Print Code: E(1), N(8)



New



Moly 20526

Jewellery Wrap. PU.
 Schmuckbox. PU.
 Etui Bijoux. Similicuir.
 Sieradendoosje. PU.

8.5 x 4 x 4 cm 200 / 50 Print Code: C(1)



Anymak 2692

 Made in Europe

Terrarium. Borosilicate Glass/ Cork. Cactus Seeds Included.
 Terrarium. Borosilikat Glas/ Kork. Inklusive Kaktussamen.
 Terrarium. Verre Borosilicate/ Liège. Graines de Cactus Incluses.
 Terrarium. Borosilicate Glas/ Kurk. Cactuszaden Inbegrepen.

 Ø 8.3 x 14.8 cm  24  Print Code: E(f), L1



A



B

Winsu 1932

Seed Bonbons. Glas/ Cork. Wildflowers.
 Bonbon-Samen. Glas/ Kork. Wilde Blumen.
 Bonbon Graines. Verre/ Liège. Fleurs Sauvages.
 Bonbon Zaden. Glas/ Kurk. Wilde Bloemen.

 Ø 3 x 7.8 cm  200 / 50  Print Code: E(f), L1





New

LAVENDER, FENNEL, DILL

Nioxis 2749

Seed Capsules Set. Recycled Cardboard. 3 Pieces.
 Samenkapsel Set. Recycling Pappe. 3 Stück.
 Set Capsule de Graine. Carton Recyclé. 3 Pièces.
 Capsules Zaden Set. Gerecycled Karton. 3 Stuks.

9.2 x 5.7 x 0.8 cm 1000 / 250 Print Code: B(1)



New

BASIL, FENNEL, PARSLEY, OREGANO

Dinaclex 2750

Seed Bonbons Set. 7 Pieces.
 Bonbon-Samen Set. 7 Stück.
 Set Bonbon Graines. 7 Pièces.
 Bonbon Zaden Set. 7 Stuks.

Ø 1.5 x 10 cm 800 / 200 Print Code: B(1)



TOMATO, BASIL, CAMOMILE, ROCKET

Made in Europe

Tomarux 2641

Garden Kit. Recycled Cardboard. 4 Pieces.
 Gartenset. Recycling Pappe. 4 Stück.
 Kit Verger. Carton Recyclé. 4 Pièces.
 Groententuin Kit. Gerecycled Karton. 4 Stuks.

8.4 x 3.2 x 8.4 cm 100 Print Code: C(1)



Made in Europe

Biyok 2642

Seed Capsules. Recycled Cardboard. Wildflowers.
 Samenkapsel. Recycling Pappe. Wilde Blumen.
 Capsule de Graine. Carton Recyclé. Fleurs Sauvages.
 Capsules Zaden. Gerecycled Karton. Wilde Bloemen.

5 x 6.6 x 1.4 cm 1000 / 250 Print Code: B(4)



Made in Europe

Mussox 2640

Seed Bonbons. Recycled Cardboard. Wildflowers.
 Bonbon-Samen. Recycling Pappe. Wilde Blumen.
 Bonbon Graines. Carton Recyclé. Fleurs Sauvages.
 Bonbon Zaden. Gerecycled Karton. Wilde Bloemen.

4.4 x 9.1 x 3 cm 400 / 50 Print Code: B(4)



Lisa 20142



Aromatic Candle. Glass. Pine Aroma. Pine Seeds Included.
 Duftkerze. Glas. Pinien Aroma. Piniensamen Inklusive.
 Bougie Aromatique. Verre. Arôme Pin. Graines de Pin Incluses.
 Geurkaars. Glas. Pijnboom Aroma. Pijnboom Zaden Inclusief.

📏 4.3 x 4.9 cm 📖 100 🖨️ Print Code: E(1), L1



PINE SEEDS



Krusty 20141

Seeds Keyring. Wood. Pine Seeds Included.
 Samen Schlüsselanhänger. Holz. Piniensamen Inklusive.
 Porte-Clés Ensemencé. Bois. Graines de Pin Incluses.
 Zaad Sleutelhanger. Hout. Pijnboom Zaden Inclusief.

📏 4 x 0.3 cm 📖 250 / 50 🖨️ Print Code: D(1), L1

PINE SEEDS



Bitar 20950

Seeds Notebook. Seed Paper. 80 Sheets. Petunia Seeds Included.
 Assorted Coloured Flowers.
 Samen Notizbuch. Samenpapier. 80 Blätter. Petuniensamen Inklusive.
 In verschiedenen Farben.

Cahier Ensemencé. Papier Ensemencé. 80 Feuilles. Graines de Pétunia Incluses. Fleurs Couleurs Diverses.
 Zaad Notitieboek. Zaadpapier. 80 Blaadjes. Petunia Zaden Inclusief.
 Assortiment van Gekleurde Bloemen.

📏 16 x 21 x 1.6 cm 📖 50 / 25 🖨️ Print Code: E(4)



New

Hakala 20969

Seeds Folder. Recycled Cardboard. Wildflowers.
 Samen Mappe. Recycling Pappe. Wilde Blumen.
 Porte-Documents Ensemencé. Carton Recyclé. Fleurs Sauvages.

Zaad Map. Gerecycled Karton. Wilde Bloemen.
 📏 22 x 30 x 0.5 cm 📖 50 🖨️ Print Code: F(1)



New



Hati 20972

Seed Stick. Wood. Wildflowers.
Samenstok. Holz. Wilde Blumen.
Bâton de Graines. Bois. Fleurs Sauvages.
Zaadstok. Hout. Wilde Bloemen.

1.6 x 9.2 x 0.3 cm 400 / 50 Print Code: B(1)

New



Liani 20973

Heart Seeds. Wood. Wildflowers.
Herz Samen. Holz. Wilde Blumen.
Cœur Graines. Bois. Fleurs Sauvages.
Hart Zaden. Hout. Wilde Bloemen.

5.3 x 5.7 x 0.3 cm 400 / 50 Print Code: B(1)



New



Bernaye 20971

Seeds Bookmark. Recycled Cardboard. Sunflower Seeds Included.
Samen Lesezeichen. Recycling Pappe. Sonnenblumensamen Inklusive.
Marque Pages Ensemencé. Carton Recyclé. Graines de Tournesol Incluses.
Zaad Bladwijzer. Gerecycled Karton. Zonnebloem Zaden Inclusief.

5.5 x 15 x 0.2 cm 400 / 100 Print Code: B(4)

New



Etesio 20970

Seeds Pencil. Wood. Pine Seeds Included.
Samen Bleistift. Holz. Piniensamen Inklusive.
Crayon Ensemencé. Bois. Graines de Pin Incluses.
Zaad Potlood. Hout. Pijnboom Zaden Inclusief.



Ø 0.7 x 17.5 cm 200 / 50 Print Code: B(4)



 Made in Europe

Mendrax 2673

Garden Kit. Wood. 3 Pieces.
Gartenset. Holz. 3 Stück.
Kit Verger. Bois. 3 Pièces.
Groentuint Kit. Hout. 3 Stuks.



 21.5 x 7 x 8 cm  40
 Print Code: E(4), L2, W

PARSLEY, BASIL,
CORIANDER

 Made in Europe

Gulytel 2690

Flowerpot. Cork. Pine Seeds Included.
Blumentopf. Kork. Kiefern Samen Inklusive.
Pot de Fleurs. Liège. Pépins de Pin Incluses.
Bloempot. Kurk. Dennenzaden Inclusief.

 8.5 x 7.5 x 7.5 cm  100
 Print Code: E(4), L1



Merin 6223

Flowerpot. Wood. Biodegradable Pot. Mint Seeds Included.
Blumentopf. Holz. Kompostierbarer Topf. Minzensamen Inklusive.
Pot de Fleurs. Bois. Pot Biodegradable. Semences de Menthe Incluses.
Bloempot. Hout. Alfbreekbare Pot. Munt Zaden Inclusief.

 8 x 8.5 x 8 cm  60  Print Code: E(4), L1



Sober 6484



Grow Pouch. Recycled Paper. 5-8 Petunia Seeds Included. Assorted Coloured Flowers.
Blumentopf. Recycling Papier. 5-8 Petuniasamen Inklusive. In verschiedenen Farben.
Pot de Fleurs. Papier Recyclé. 5-8 Graines de Pétunia Incluses. Fleurs Couleurs Diverses.
Bloempot. Gerecycled Papier. 5-8 Petunia Zaden Inclusief. Assortiment van Gekleurde Bloemen.

 11 x 13 x 5 cm  500 / 50  Print Code: D(1)



Lucrul 1930

Grow Pouch. Recycled Paper. Wildflowers.
Blumentopf. Recycling Papier. Wilde Blumen.
Pot de Fleurs. Papier Recyclé. Fleurs Sauvages.
Bloempot. Gerecycled Papier. Wilde Bloemen.

 6.5 x 10.5 cm  1000 / 500  Print Code: B(4)



PRESLEY

MINT

SET 2 PIECES

Nertel 5113

Flowerpot Set. Biodegradable Pot. 2 Pieces. Seeds Included.
 Blumentopf Set. Kompostierbarer Topf. 2 Stück. Samen Inklusiv.
 Set Pot de Fleurs. Pot Biodégradable. 2 Pièces. Graines Incluses.
 Bloempot Set. Biologisch Afbrekbare Pot. 2 Stuks. Zaden Inclusief.

15 x 7 x 7 cm 100 / 50 Print Code: E(4)



Advert 9966

Flowerpot. Biodegradable Pot. 5-8 Petunia Seeds Included. Assorted Coloured Flowers.
 Blumentopf. Kompostierbarer Topf. 5-8 Petuniensamen Inklusiv. In verschiedenen Farben.
 Pot de Fleurs. Pot Biodégradable. 5-8 Graines de Pétunia Incluses. Fleurs Couleurs Diverses.
 Bloempot. Biodegradable Pot. 5-8 Petunia Zaden Inclusief. Assortiment van Gekleurde Bloemen.
 Ø 6.5 x 6.2 cm 200 / 25 Print Code: E(4)



Tumil 1929

Flowerpot. Biodegradable Pot. 5-8 Sunflower Seeds Included.
 Blumentopf. Kompostierbarer Topf. 5-8 Sonnenblumensamen Inklusiv.
 Pot de Fleurs. Pot Biodégradable. 5-8 Graines de Tournesol Incluses.
 Bloempot. Biodegradable Pot. 5-8 Zonnebloem Zaden Inclusief.

Ø 6.5 x 6.2 cm 200 / 25 Print Code: E(4)



Konte 1931

Flowerpot. Terracotta. Cactus Seeds Included.
 Blumentopf. Terrakotta. Inklusive Kaktussamen.
 Pot de Fleurs. Terre Cuite. Graines de Cactus Incluses.
 Bloempot. Terracotta. Cactuszaden Inbegrepen.

Ø 6.6 x 6.5 cm 150 / 50 Print Code: E(4)



Soltax 6791

Flowerpot. Terracotta. 5-8 Petunia Seeds Included. Assorted Coloured Flowers.
 Blumentopf. Terrakotta. 5-8 Petuniensamen Inklusiv. In verschiedenen Farben.
 Pot de Fleurs. Terre Cuite. 5-8 Graines de Pétunia Incluses. Fleurs Couleurs Diverses.
 Bloempot. Terracotta. 5-8 Petunia Zaden Inclusief. Assortiment van Gekleurde Bloemen.

Ø 5.5 x 5 cm 150 / 50 Print Code: E(1)





New



Neolux 21121

Set. Umbrella Pongee 190T. Fibreglass Ribs. 21". Windproof. Cork Handle. Pongee RPET Pouch.
Insulated Bottle Recycled Stainless Steel/ Cork. 550 ml.

Set. Regenschirm Pongee 190T. Fiberglass Rippen. 21". Antiwindsystem. Kork Griff. Pongee RPET Etui.
Wärme Flasche Recycling Rostfreier Stahl/ Kork. 550 ml.

Set. Parapluie Pongée 190T. Tiges Fibre de Verre. 21". Système Anti-Vent. Poignée Liège. Étui Pongee
RPET. Bidon Thermique Acier Inox Recyclé/ Liège. 550 ml.

Set. Paraplu Pongee 190T. Glasvezel Ribben. 21". Windbestendig. Kurk Handvat. Pongee RPET Zakje.
Thermoskan-Fles Gerecycled Roestvrij Staal/ Kurk. 550 ml.

37.8 x 9.6 x 18.4 cm 10 Print Code: F(1), G(1), L2, N(8)



New

80 Sheets
Lined

500 ml



Datiford 21122

Set. Insulated Bottle Recycled Stainless Steel, 500 ml. Notepad Polyester 300D RPET, Hard Cover, 80 Sheets. Polyester
300D RPET Pen Included.

Set. Wärme Flasche Recycling Rostfreier Stahl, 500 ml. Notizblock Polyester 300D RPET, Hardcover-Abdeckung, 80
Blätter. Polyester 300D RPET Kugelschreiber Inklusiv.

Set. Bidon Thermique Acier Inox Recyclé. 500 ml, Bloc Polyester 300D RPET, Couverture Rigide, 80 Feuilles. Stylo
Polyester 300D RPET Inclus.

Set. Thermoskan-Fles Gerecycled Roestvrij Staal, 500 ml. Notepad Polyester 300D RPET, Harde Kaft, 80 Blaadjes. Pen
Polyester 300D RPET Inclusief.

30 x 8.2 x 27.2 cm 5 Print Code: F(1), C(1), G(1), L2, N(8)



Dickinson 20732



Set. Stainless Steel/ Bamboo. Insulated Bottle 500 ml. 2 Insulated Cup 300 ml.
 Set. Rostfreier Stahl/ Bambus. Wärme Flasche 500 ml. 2 Wärme Trinkbecher 300 ml.
 Set. Acier Inox/ Bambou. Bidon Thermique 500 ml. 2 Verre Thermique 300 ml.
 Set. Roestvrij Staal/ Bamboe. Borraccia Termica 500 ml. 2 Beker-Fles 300 ml.

25.8 x 9.5 x 21.4 cm 15 Print Code: G(1), L2, L3

New



500 ml

300 ml



640 ml



Halderan 1341

Set. Vacuum Flask Stainless Steel/ Bamboo, 640 ml. Notepad PU/ Bamboo, Hard Cover. 80 Sheets. Pen Aluminium/ Bamboo.

Set. Thermoskanne Rostfreier Stahl/ Bambus, 640 ml. Notizblock PU/ Bambus, Hardcover-Abdeckung. 80 Blätter. Kugelschreiber Aluminium/ Bambus.

Set. Thermo Acier Inox/ Bambou, 640 ml. Bloc Simitlicuir/ Bambou, Couverture Rigide. 80 Feuilles. Stylo Aluminium/ Bambou.

Set. Thermosfles Roestvrij Staal/ Bamboe, 640 ml. Notepad PU/ Bamboe, Harde Kaft. 80 Blaadjes. Pen Aluminium/ Bamboe.

32.5 x 8 x 27.6 cm 5 Print Code: F(1), L2

80 Sheets Lined

ANTONIO MIRO



Nimaly 7379

100 Sheets Lined

Set. Polyester 300D/ Metal. Notepad Hard Cover. 100 Sheets. Pen.
 Set. Polyester 300D/ Metall. Notizblock Hardcover-Abdeckung. 100 Blätter. Kugelschreiber.
 Set. Polyester 300D/ Métal. Bloc Notes Couverture Rigide. 100 Feuilles. Stylo.
 Set. Polyester 300D/ Staal. Notitieblokje Harde Kaft. 100 Blaadjes. Pen.

24 x 21.5 x 4 cm 20/ 10 Print Code: E(1), L1, N(8)



500 ml



Gregory 20238

Set. Umbrella Pongée 190T, Fiberglass Ribs, 21". Windproof. Pongee RPET Pouch. Insulated Bottle Recycled Stainless Steel, 500 ml. Notepad Polyester 300D RPET, Hard Cover, 80 Sheets. Polyester 300D RPET Pen Included.

Set. Regenschirm Pongée 190T, Fiberglass Rippen, 21". Antiwindsystem. Pongee RPET Etui. Wärme Flasche Recycling Rostfreier Stahl, 500 ml. Notizblock Polyester 300D RPET, Hardcover-Abdeckung, 80 Blätter. Polyester 300D RPET Kugelschreiber Inklusiv.

Set. Parapluie Pongée 190T, Tiges Fibre de Verre, 21". Système Anti-Vent. Étui Pongée RPET. Bidon Thermique Acier Inox Recyclé. 500 ml. Bloc Polyester 300D RPET, Couverture Rigide, 80 Feuilles. Stylo Polyester 300D RPET Inclusif.

Set. Paraplu Pongée 190T, Glasvezel Ribben, 21". Windbestendig. Pongee RPET Zakje. Thermoskan-Fles Gerecycled Roestvrij Staal, 500 ml. Notepad Polyester 300D RPET, Harde Kaft, 80 Blaadjes. Pen Polyester 300D RPET Inclusief.

35.5 x 7.5 x 31 cm 5 Print Code: F(1), C(1), G(1), L2, N(8)

80 Sheets Lined





Kyala 20608

Decorative Plant. Glass. 5 Leds. 3 Batteries AAA Not Included.
 Dekorpflanze. Glas. 5 Leds. 3 AAA Batterien Nicht im Lieferumfang.
 Plante Décorative. Verre. 5 Leds. 3 Piles AAA Non Incluses.
 Decoratieve Plant. Glas. 5 Leds. 3 Batterijen AAA Niet Inclusief.

📏 Ø 8 x 14 cm 📦 15 🗣️ Print Code: E(1), L1, V

New



Rodina 20609

Lamp. Glass. 20 Leds. Solar Charging. Battery 300 mAh.
 Lampe. Glas. 20 Leds. Solarladung. Batterie 300 mAh.
 Lampe. Verre. 20 Leds. Charge Solaire. Batterie 300 mAh.
 Lamp. Glas. 20 Leds. Zonnelading. KabelBatterij 300 mAh.

📏 Ø 7.8 x 13.5 cm 📦 20 🗣️ Print Code: F(1), L2



Joneson 20607

Lamp. Wood. 16 Leds. 2 Light Modes. Foldable. Battery 700 mAh.
 Lampe. Holz. 16 Leds. 2 Lichtpositionen. Faltbar. Batterie 700 mAh.
 Lampe. Bois. 16 Leds. 2 Modes de Lumière. Pliable. Batterie 700 mAh.
 Lamp. Hout. 16 Leds. 2 Licht Posities. Opvouwbaar. Batterij 700 mAh.

📏 9 x 12 x 2.4 cm 📦 50 🗣️ Print Code: E(1), L2, W

Huntan 20605

Water Fountain. 1 Led. 20 Pietre Incline. 3 Piles AA Non Included.
 Wasserquelle. 1 Led. 20 Steine Enthalt. 3 AA Batterien Nicht im Lieferumfang.
 Source d'eau. 1 Led. 20 Pierres Incluses. 3 Piles AA Non Inclus.
 Waterfontein. 1 Led. 20 Stenen Inbegrepen. 3 Batterijen AA Niet Inclusief.

📏 11.3 x 15.3 x 8.5 cm 📦 20 🗣️ Print Code: E(1)



AROMATIC

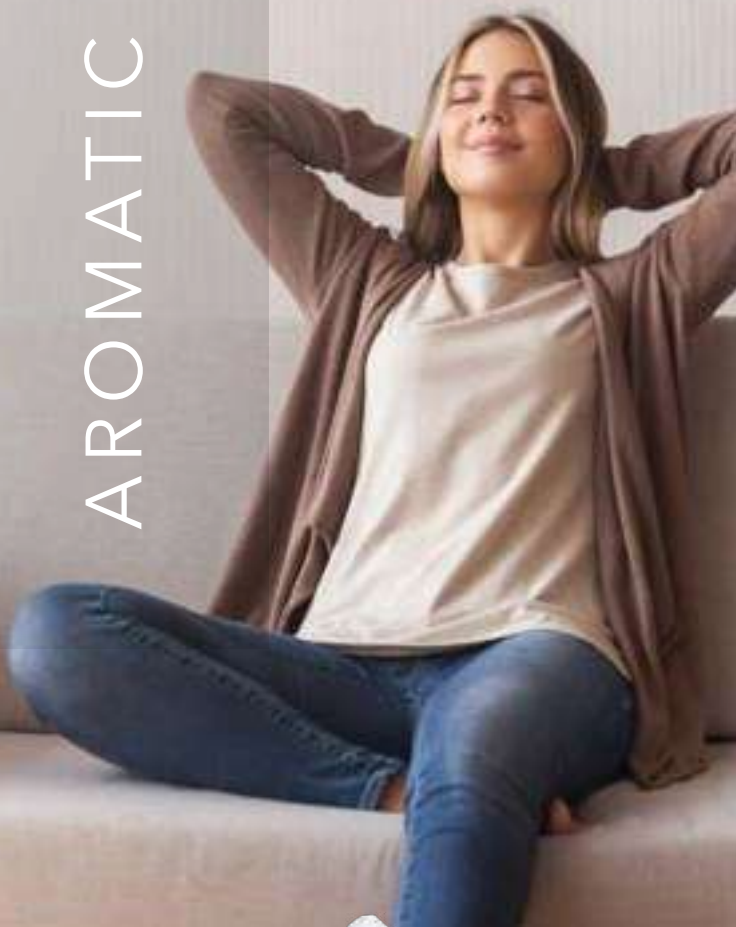

240 ml

Aurion 20576

Humidifier. Multicolour Led Lights. 240 ml. 2 Steam Modes. USB Connection. Fan Included.
 Luftbefeuchter. Mehrfarbige Led Lichten. 240 ml. 2 Dampf Funktionen. USB Anschluss. Ventilator Inklusive.
 Humidificateur. Lumières Led Multicolores. 240 ml. 2 Modes de Vapeur. Connexion USB. Ventilateur Inclusive.
 Luchtbevochtiger. Meerkleurige Led Lichten. 240 ml. 2 Stoom Posities. USB Verbinding. Ventilator Inclusief.

6.5 x 16.2 x 6.5 cm 40 Print Code: E(4)



New



Sarenel 20699



Aromatic Diffuser. Glass. 10 Crystal Stones. Oil 10 ml. Lavender Aroma.
 Aromatischer Diffusor. Glas. 10 Kristallsteine. Öl 10 ml. Lavendel Aroma.
 Diffuseur Aromatique. Verre. 10 Pierres de Cristal. Huile 10 ml. Arôme Lavande.
 Luchtverfrisser. Glas. 10 Kristalstenen. Olie 10 ml. Lavendel Aroma.

8.8 x 5.1 cm 20 Print Code: E(1), L1



New



150 ml

Boucher 20910



Aromatic Diffuser. Pink Himalayan Salt Stones. Oil 10 ml. Lavender Aroma. Multicolour Led Lights. 150 ml. 1 Steam Mode. USB Connection.

Aromatischer Diffusor. Pink-Salzmühle Himalaya. Öl 10 ml. Lavendel Aroma. Led Lichten. Mehrfarbige Led Lichten. 150 ml. 1 Dampf Funktion. USB Anschluss.

Diffuseur Aromatique. Pierres Roses de Sel de l'Himalaya. Huile 10 ml. Arôme Lavande. Lumières Led Multicolores. 150 ml. 1 Mode de Vapeur. Connexion USB.

Luchtverfrisser. Roze Himalaya Zoutstenen. Olie 10 ml. Lavendel Aroma. Meerkleurige Led Lichten. 150 ml. 1 Stoom Positie. USB Verbinding.

9 x 9.7 cm 30 / 15 Print Code: E(1)



New

New



Jamet 21024

Hair Trimmer: 3 Accessories, 1 Battery AA Not Included.
Haarschneider: 3 Teile, 1 AA Batterie Nicht im Lieferumfang.
Tondeuse à Cheveux: 3 Accessoires, 1 Pile AA Non Inclusive.
Haartrimmer: 3 Accessoires, 1 Batterij AA Niet Inclusief.

3.2 x 10.5 x 4.3 cm 50 / 25 Print Code: F(4)



Kiop 20366

Iron: 25W, AC 220-240V.
Bügeleisen: 25W, AC 220-240V.
Fer à Repasser: 25W, AC 220-240V.
Strijkijzer: 25W, AC 220-240V.

10.6 x 6.5 x 6.3 cm 30 Print Code: F(1)



Guyit 20365

Lint Remover: 2 Batteries AA Not Included.
Flusen Entferner: 2 AA Batterien Nicht im Lieferumfang.
Rouleau Anti-Peluche: 2 Piles AA Non Inclusive.
Pluizenverwijderaar: 2 Batterijen AA Niet Inclusief.

7.3 x 15.3 x 7.1 cm 40 Print Code: F(4)



New

350 ml

Zexen 20737

Fan Bottle. Tritan. 350 ml. 3 Modes. Battery 1.200 mAh.
 Trinkflasche Ventilator. Tritan. 350 ml. 3 Positionen. Batterie 1.200 mAh.
 Bidon Ventilateur. Tritan. 350 ml. 3 Modes. Batterie 1.200 mAh.
 Fles Ventilator. Tritan. 350 ml. 3 Posities. Batterij 1.200 mAh.

Ø 8,5 × 16 cm 50 Print Code: F(1)

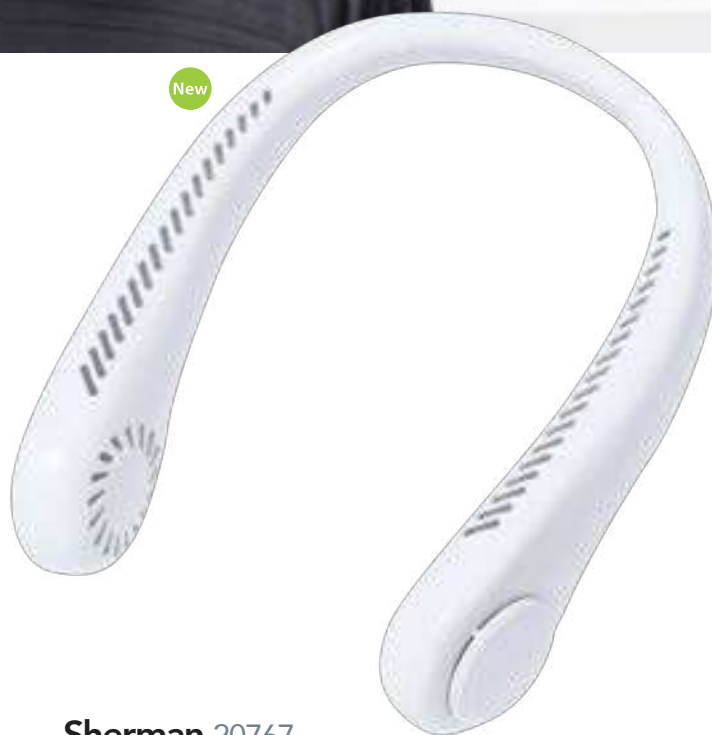

New

Sherman 20767

Fan. 3 Modes. Battery 1200 mAh.
 Ventilator. 3 Positionen. Batterie 1200 mAh.
 Ventilateur. 3 Modes. Batterie 1200 mAh.
 Ventilator. 3 Posities. Batterij 1200 mAh.

14 × 22 × 6,2 cm 50 Print Code: F(1)

New

Echem 20562

Massager. Wood.
 Massagegerät. Holz.
 Masseur. Bois.
 Massage-Vorm. Hout.

8.5 x 15 x 1.5 cm 200 / 100 Print Code: C(4), L1



WOOD & BAMBOO MASSAGER



New

Avati 20561

Massager. Wood.
 Massagegerät. Holz.
 Masseur. Bois.
 Massage-Vorm. Hout.

12 x 9 x 10 cm 100 / 50 Print Code: D(1), L1

**Goonix 1649**

Massager. Metal/ Bamboo.
 Massagegerät. Metall/ Bambus.
 Masseur. Métal/ Bambou.
 Massage-Vorm. Metaal/ Bamboe.

11 x 23 x 11 cm 50 Print Code: D(1), L1

**Wendy 1650**

Massager. Bamboo.
 Massagegerät. Bambus.
 Masseur. Bambou.
 Massage-Vorm. Bamboe.

11.3 x 8.6 x 1.4 cm 150 / 50 Print Code: C(4), L1



Latval 20564

Massager. Led Lights. 3 Piles AAA Non Included.
 Massagegerät. Led Lichter. 3 AAA Batterien Nicht im Lieferumfang.
 Masseur. Lumières Led. 3 Piles AAA Non Incluses.
 Massage-Vorm. Led Lichten. 3 Batterijen AAA Niet Inclusief.

10.2 x 9.5 x 9.5 cm 50 Print Code: E(1)



Wuklu 20563

Massager.
 Massagegerät.
 Masseur.
 Massage-Vorm.

10.5 x 7 x 8.5 cm 50 Print Code: E(1)



Wally 20179

Massager. 2 Modes. Battery 800 mAh. Polyester RPET Pouch.
 Massagegerät. 2 Positionen. Batterie 800 mAh. Polyester RPET Etui.
 Masseur. 2 Modes. Batterie 800 mAh. Étui Polyester RPET.
 Massage-Vorm. 2 Posities. Batterij 800 mAh. Polyester RPET Zakje.

11.3 x 10.2 x 5 cm 50 Print Code: E(1), F(1), N(8)



Owura 20452

Massager. 4 Accessories. 6 Modes. Battery 1200 mAh.
 Massagegerät. 4 Teile. 6 Positionen. Batterie 1200 mAh.
 Masseur. 4 Accessoires. 6 Modes. Batterie 1200 mAh.
 Massage-Vorm. 4 Accessoires. 6 Posities. Batterij 1200 mAh.

21 x 18.5 x 5.5 cm 10 Print Code: I(1)



NEW
COLOR**Ventry 5699**

Antistress. PU.
Antistress. PU.
Antistress. PU.
Antistress. PU.

7.1 x 7 x 5 cm 400 / 10
Print Code: E(1), L1, W

**Gotin 5257**

Antistress. PU.
Antistress. PU.
Antistress. PU.
Antistress. PU.

Ø 6 x 8 cm 400 / 10 Print Code: E(1), L1, W



SAN



PLA

TOMA

LIM

FRE

MAN

NARA

Fruty 4397

Antistress Keyring. PU.
Antistress Schlüsselanhänger. PU.
Porte-Clés Antistress. PU.
Antistress Sleutelhanger. PU.

Consult. 1000 / 10 Print Code: E(1), L1

**Silene 3658**

Antistress Keyring. PU.
Antistress Schlüsselanhänger. PU.
Porte-Clés Antistress. PU.
Antistress Sleutelhanger. PU.

3.6 x 3.6 x 2.7 cm 1000 / 20
Print Code: E(1), L1, W



Chaiss 6969

Antistress Ball. PU.
Antistress Ball. PU.
Balle Antistress. PU.
Antistress Bal. PU.

📏 Ø 5.7 cm 📦 400 / 10 🗣️ Print Code: E(t), L1, W



16

NEW
COLOR

21



17



22



02

01

19

11

04

03

07

05

Lasap 4605

Antistress Ball. PU.
Antistress Ball. PU.
Balle Antistress. PU.
Antistress Bal. PU.

📏 Ø 6.2 cm 📦 400 / 10 🗣️ Print Code: E(t), L1, W



Kidea 4270

Antistress. PU.
Antistress. PU.
Antistress. PU.
Antistress. PU.

📏 Ø 6 x 10 cm 📦 250 / 50 🗣️ Print Code: E(t), L1, W



Dozgu 1912

Antistress. PU.
Antistress. PU.
Antistress. PU.
Antistress. PU.

📏 9.1 x 4.9 x 5.2 cm 📦 400 / 10 🗣️ Print Code: E(t), L1, W





Recsum 5176

Plaque. Glass.
Plakette. Glas.
Plaque. Verre.
Plaque. Glas.

14 x 19 x 4.5 cm 10
 Print Code: F(2), L2



Owen 5175

Plaque. Glass.
Plakette. Glas.
Plaque. Verre.
Plaque. Glas.

10 x 11 x 6 cm 20
 Print Code: F(2), L2



Nelum 4429

Plaque. Glass.
Plakette. Glas.
Plaque. Verre.
Plaque. Glas.

14 x 14 x 6.3 cm 40 Print Code: F(2), L2, W



Cirlam 5043

Paperweight. Glass.
Briefbeschwerer. Glas.
Presse-Papier. Verre.
Presse-Papier. Glas.

Ø 8 x 4 cm 30 / 10 Print Code: L2



World 3661

Ball. Glass.
Kugel. Glas.
Sphère. Verre.
Wereldbol. Glas.

6 x 7.8 x 6 cm 30 Print Code: F(2), L2



Cudor 5042

Paperweight. Glass.
Briefbeschwerer. Glas.
Presse-Papier. Verre.
Presse-Papier. Glas.



5 x 5 x 5 cm 30 / 10 Print Code: L2





Bersix 1548



Plaque. Glass/ Wood.
Plakette. Glas/ Holz.
Plaque. Verre/ Bois.
Plaque. Glas/ Hout.

10.5 x 26.5 x 3.8 cm  10
 Print Code: F(2), L2, W



Vertu 1546

Plaque. Glass/ Wood.
Plakette. Glas/ Holz.
Plaque. Verre/ Bois.
Plaque. Glas/ Hout.

15 x 18 x 3.5 cm  10
 Print Code: F(2), L2, W



Pulman 1547

Plaque. Glass/ Wood.
Plakette. Glas/ Holz.
Plaque. Verre/ Bois.
Plaque. Glas/ Hout.

15 x 24.5 x 3.8 cm  10
 Print Code: F(2), L2, W



Nigrum 1253

Trophy. Glass.
Pokal. Glas.
Coupe. Verre.
Trofee. Glas.

7 x 25.5 x 7 cm  10  Print Code: F(2), L2



Lanton 1252

Trophy. Glass.
Pokal. Glas.
Coupe. Verre.
Trofee. Glas.

8.2 x 23 x 5.8 cm  10  Print Code: F(2), L2



Band Included

Guster 1540

Medal. Cotton/ Wood. Safety Catch.
 Médaille. Baumwolle/ Holz. Sicherheitsverschluss.
 Médaille. Coton/ Bois. Fermeture Sécurité.
 Medaille. Katoen/ Hout. Veiligheidsluiting.

📏 Ø 7 x 45 cm 📦 500 / 100
 🖨️ Print Code: D(1), G(1), L1, N(8)

**Konial 1190**

Medal. Metal.
 Médaille. Métall.
 Médaille. Métal.
 Medaille. Metaal.

📏 Ø 5 x 48 cm 📦 500 / 50
 🖨️ Print Code: D(1), G(1), L1, N(8), V

Maclein 1191

Medal. Metal.
 Médaille. Métall.
 Médaille. Métal.
 Medaille. Metaal.

📏 Ø 5 x 50 cm 📦 500 / 50 🖨️ Print Code: D(1), G(1), L1, N(8), W

Corum 3743

Medal. Metal.
 Médaille. Métall.
 Médaille. Métal.
 Medaille. Metaal.

📏 Ø 5 x 50 cm 📦 500 / 50
 🖨️ Print Code: D(1), G(1), L1, N(8)

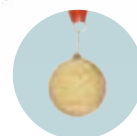

BACK PART



04



19

05

03

02

01



Royers 2616

Pin. Bamboo. Magnetic.
Pin. Bambus. Magnetisch.
Pin. Bambou. Magnétique.
Speld. Bamboe. Magnetisch.

4,5 X 4,5 1600 / 400 Print Code: B(4), L1



Turmi 3741

Pin.
Pin.
Pin.
Speld.

Ø 3 cm 4000 / 200 Print Code: B(1)

Suju 20636

Pin.
Pin.
Pin.
Speld.

Ø 4.4 cm 2000 / 100 Print Code: B(1), W

Varek 20637

Pin.
Pin.
Pin.
Speld.

Ø 6 cm 1000 / 100 Print Code: B(1), W

Special doming

PIN DOMING

minimum 300 pcs - mínimo 300 pcs
Full colour printing + Doming included,
set up cost not included.

minimum 300 pcs - mínimo 300 pcs
Full colour printing + Doming included,
set up cost not included.

Batler 4607

Pin. Metal.
Pin. Metall.
Pin. Métal.
Speld. Metaal.

Consult. 1000 / 500 Print Code:



Formix 4762

Pin.
Pin.
Pin.
Speld.

Consult. 5000 / 100 Print Code: Consult.

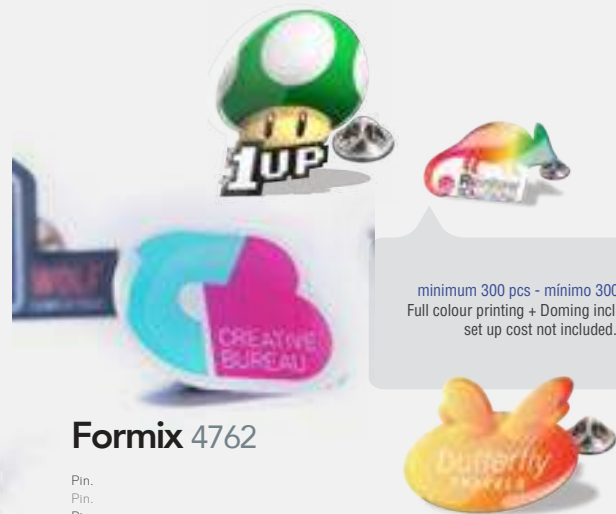

Rainbow



Poison 1927

Pen.
Kugelschreiber.
Stylo.
Pen.

Ø 1.3 x 14 cm 1000 / 50 Print Code: A(4)



370 ml

Mercurik 1925

Mug. Ceramic. 370 ml.
Tasse. Keramik. 370 ml.
Tasse. Céramique. 370 ml.
Mok. Keramiek. 370 ml.

Ø 8.2 x 9.8 cm 36 Print Code: F(1)



790 ml

Jedet 1923

Bottle. Stainless Steel. 790 ml.
Trinkflasche. Rostfreier Stahl. 790 ml.
Bidon. Acier Inox. 790 ml.
Fles. Roestvrij Staal. 790 ml.

Ø 7.1 x 26.8 cm 50 Print Code: F(1), W



100 Sheets
Plain

Locomix 1926

Notepad. PU. Hard Cover. 100 Sheets.
Notizblock. PU. Hardcover-Abdeckung. 100 Blätter.
Bloc Notes. Similicuir. Couverture Rigide. 100 Feuilles.
Notitieblokje. PU. Harde Kaft. 100 Blaadjes.

14.7 x 21 x 1.5 cm 50 / 25 Print Code: E(1)



Marsha 1921

RPET ♻️

Drawstring Bag. Polyester 210T RPET.
Rucksack. Polyester 210T RPET.
Sac à Dos. Polyester 210T RPET.
Rugzak. Polyester 210T RPET.

34 x 42 cm 300 / 50 Print Code: F(1), N(8)



Rubiros 1924

RPET ♻️

Bag. Polyester 210T RPET.
Tasche. Polyester 210T RPET.
Sac. Polyester 210T RPET.
Tas. Polyester 210T RPET.

37 x 41 cm 200 / 10 Print Code: F(1), N(8)



Zerolox 1928

Flag. Polyester 170D.
Fahne. Polyester 170D.
Drapeau. Polyester 170D.
Vlag. Polyester 170D.

100 x 70 cm 200 / 10 Print Code: G(1)



Faralax 20974

Neckerchief. Polyester 170T.
Halstuch. Polyester 170T.
Foulard. Polyester 170T.
Bandana. Polyester 170T.

100 x 70 cm 1000 / 10 Print Code: F(1), N(8)

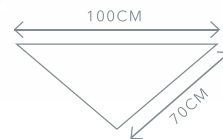

Rupaul 1922

Hand Fan. RPET/ Polyester.
Fächer. RPET/ Polyester.
Éventail. RPET/ Polyester.
Waaier. RPET/ Polyester.

43 x 23 cm 250 / 25 Print Code: D(1), E(2)

RPET



Jabisk 20975

Bracelet. Polyester/ ABS. Adjustable.
Armband. Polyester/ ABS. Verstelbaar.
Bracelet. Polyester/ ABS. Ajustable.
Armband. Polyester/ ABS. Aanpasbaar.

34.5 x 1.2 cm 2000 / 500 Print Code: D(1), N(8)



New



New

Mapik 20930

Lanyard. Polyester. Safety Catch.
Schlüsselband. Polyester. Sicherheitsverschluss.
Lanyard. Polyester. Fermeture Sécurité.
Lanyard. Polyester. Veiligheidsluiting.

2 x 50 cm 800 / 100 Print Code: G(1), N(8)



Mendol 5060

Bracelet. Polyester/ ABS. Adjustable.
Armband. Polyester/ ABS. Verstelbaar.
Bracelet. Polyester/ ABS. Ajustable.
Armband. Polyester/ ABS. Aanpasbaar.

34.5 x 1.2 cm 2000 / 500 Print Code: D(1), R



Plasker 5061

Bracelet. Polyester/ ABS. Adjustable. Safety Catch.
Armband. Polyester/ ABS. Verstelbaar. Sicherheitsverschluss.
Bracelet. Polyester/ ABS. Ajustable. Fermeture Sécurité.
Armband. Polyester/ ABS. Aanpasbaar. Veiligheidsluiting.

35 x 1.5 cm 2000 / 500 Print Code: D(1), R



RPET ♻️

Broch 6973

Bracelet. Polyester RPET/ Bamboe. Adjustable. Safety Catch.
Armband. Polyester RPET/ Bamboe. Verstelbaar. Sicherheitsverschluss.
Bracelet. Polyester RPET/ Bamboe. Ajustable. Fermeture Sécurité.
Armband. Polyester RPET/ Bamboe. Aanpasbaar. Veiligheidsluiting.

35 x 1.5 cm 2000 / 500 Print Code: D(1), R



Bosgo 1542

Bracelet. 100% Cotton/ Bamboe. Adjustable. Safety Catch.
Armband. 100% Baumwolle/ Bamboe. Verstelbaar. Sicherheitsverschluss.
Bracelet. 100% Cotton/ Bamboe. Ajustable. Fermeture Sécurité.
Armband. 100% Katoen/ Bamboe. Aanpasbaar. Veiligheidsluiting.

35 x 1.5 cm 2000 / 500 Print Code: D(1), N(8)

New



Naomi 20242

Holder Bracelet. Silicone.
Halter Armband. Silikon.
Bracelet Support. Silicone.
Houder Armband. Siliconen.

Ø 8.7 x 0.7 cm 500 / 100 Print Code: E(1), L1





Waylen 5852

Sublimation Bracelet. Polyester.
Sublimations Armband. Polyester.
Bracelet Sublimation. Polyester.
Sublimatie Armband. Polyester.

 30 x 1.5 cm  Print Code: R



Nopak 5454

Sublimation Lanyard. Polyester.
Sublimations Schlüsselband. Polyester.
Lanyard Sublimation. Polyester.
Sublimatie Lanyard. Polyester.

 2.5 x 50 cm  600 / 100  Print Code: R



Lerop 2598

Sublimation Lanyard. Polyester.
Sublimations Schlüsselband. Polyester.
Lanyard Sublimation. Polyester.
Sublimatie Lanyard. Polyester.

 2.5 x 100 cm  500  Print Code: R





Parsok 2552

19

Lighter.
Feuerzeug.
Briquet.
Aansteker.

2.3 x 8.1 x 1.1 cm 1000 / 50 Print Code: A(4), W



Fenick 2536

NEON COLOUR

Lighter.
Feuerzeug.
Briquet.
Aansteker.

2.4 x 8 x 1.1 cm 1000 / 50 Print Code: A(4), W

NOT FOR INDIVIDUAL SALE
ASSORTED COLOURS



Stromber 2549

NEON COLOUR

Lighter. Refillable.
Feuerzeug. Wiederaufladbar.
Briquet. Rechargeable.
Aansteker. Navulbaar.

2.2 x 8 x 1.7 cm 576 / 24 Print Code: A(4)

NOT FOR INDIVIDUAL SALE
ASSORTED COLOURS



Minicricket 2483

Lighter.
Feuerzeug.
Briquet.
Aansteker.

2.2 x 5.8 x 1 cm 500 / 50 Print Code: A(4), W

Deuston 2537

Lighter. Metal. Refillable.
Feuerzeug. Metall. Wiederaufladbar.
Briquet. Métal. Rechargeable.
Aansteker. Metaal. Navulbaar.

3.9 x 5.8 x 1.3 cm 360 / 12
Print Code: L1



MATTE

Kapnos 4784

Grinder.
Grinder.
Broyeur.
Grinder.

Ø 4.2 x 2 cm 500 / 20
Print Code: C(4)



19





Mundi 3906

Lighter. Refillable.
Feuerzeug. Wiederaufladbar.
Briquet. Rechargeable.
Aansteker. Navulbaar.

2.5 x 6.4 x 1.2 cm 1000 / 50
 Print Code: A(4), W



Rosser 2553

Kitchen Lighter. Refillable.
Küchen Feuerzeug. Wiederaufladbar.
Briquet Cuisine. Rechargeable.
Keuken Aansteker. Navulbaar.

2.5 x 12.3 x 1.2 cm 600 / 50
 Print Code: B(4), W



Plain 9943

Lighter. Refillable.
Feuerzeug. Wiederaufladbar.
Briquet. Rechargeable.
Aansteker. Navulbaar.

2.4 x 8 x 0.9 cm 1000 / 50
 Print Code: A(4), W



Vaygox 4845

Lighter. Refillable.
Feuerzeug. Wiederaufladbar.
Briquet. Rechargeable.
Aansteker. Navulbaar.

2.4 x 8 x 0.9 cm 1000 / 50
 Print Code: A(4), W



01



04

19

09

02

03

Berko 5696

Pocket Ashtray. PVC/ Aluminium.
Tasche Aschenbecher. PVC/ Aluminium.
Cendrier Poche. PVC/ Aluminium.
Zak-Asbak. PVC/ Aluminium.

8 x 8 x 1 cm 500 / 50 Print Code: C(1)



Flament 1600

Pocket Ashtray. Laminated Recycled Paper/ Aluminium.
Tasche Aschenbecher. Laminiertes Recycling Papier/ Aluminium.
Cendrier Poche. Papier Recyclé Laminé/ Aluminium.
Zak-Asbak. Gelamineerd Gerecycled Papier/ Aluminium.

7.5 x 8.5 x 1 cm 500 / 50 Print Code: C(1)



Dokon 1599

Pocket Ashtray. Cork/ Aluminium.
Tasche Aschenbecher. Kork/ Aluminium.
Cendrier Poche. Liège/ Aluminium.
Zak-Asbak. Kurk/ Aluminium.

8 x 8 x 1 cm 500 / 50 Print Code: C(1)





New



Makine 20993

Multitool. Stainless Steel. 13 Functions.
Multiwerkzeug. Rostfreier Stahl. 13 Funktionen.
Multi Outils. Acier Inox. 13 Fonctions.
Multitool. Roestvrij Staal. 13 Functies.

3 x 7.2 x 0.2 cm 200 / 50 Print Code: D(1), L1



New



Koburn 20994

Pocket Knife. Aluminium/ Stainless Steel.
Taschenmesser. Aluminium/ Rostfreier Stahl.
Canif. Aluminium/ Acier Inox.
Zakmes. Aluminium/ Roestvrij Staal.

2.3 x 7.5 x 0.7 cm 200 / 50 Print Code: D(1), L1, V



New

Vireon 20487

Multitool. Stainless Steel. 1 Led. 16 Functions. Button Batteries Included.
Multiwerkzeug. Rostfreier Stahl. 1 Led. 16 Funktionen. Knopfzellen Inklusiv.
Multi Outils. Acier Inox. 1 Led. 16 Fonctions. Piles Bouton Incluses.
Multitool. Roestvrij Staal. 1 Led. 16 Functies. Knoopcel Batterijen Inclusief.

8.5 x 5.3 x 0.9 cm 200 / 100 Print Code: D(1), L1



New



Olexa 20458

Multitool. Stainless Steel. 16 Functions.
Multiwerkzeug. Rostfreier Stahl. 16 Funktionen.
Multi Outils. Acier Inox. 16 Fonctions.
Multitool. Roestvrij Staal. 16 Functies.

4.2 x 12.7 x 0.9 cm 200 / 50
Print Code: D(1), L1



Zorlix 20996

Multitool. Stainless Steel. 18 Functions.
Multiwerkzeug. Rostfreier Stahl. 18 Funktionen.
Multi Outils. Acier Inox. 18 Fonctions.
Multitool. Roestvrij Staal. 18 Functies.

12 x 3.8 x 0.2 cm 200 / 50 Print Code: D(1), L1



Telep 20997

Multitool. Stainless Steel. 16 Functions.
Multiwerkzeug. Rostfreier Stahl. 16 Funktionen.
Multi Outils. Acier Inox. 16 Fonctions.
Multitool. Roestvrij Staal. 16 Functies.

10 x 6.5 x 0.2 cm 200 / 50 Print Code: D(1), L1



Flanery 20998

Multitool. Stainless Steel. 1 Led. 11 Functions. Button Battery Included.
Multiwerkzeug. Rostfreier Stahl. 1 Led. 11 Funktionen. Knopfzelle inklusive.
Multi Outils. Acier Inox. 1 Led. 11 Fonctions. Pile Bouton Incluse.
Multitool. Roestvrij Staal. 1 Led. 11 Functies. Knoepcel Batterij Inclusief.

10.5 x 6.5 x 0.2 cm 200 / 50 Print Code: D(1), L1



Balint 20995

Multitool. Stainless Steel. 16 Functions.
Multiwerkzeug. Rostfreier Stahl. 16 Funktionen.
Multi Outils. Acier Inox. 16 Fonctions.
Multitool. Roestvrij Staal. 16 Functies.

10.7 x 6.2 x 0.2 cm 200 / 50 Print Code: D(1), L1





Famke 21009

Multitool Keyring. Wood/ Stainless Steel. 3 Functions.

Multwerkzeug Schlüsselanhänger. Holz/ Rostfreier Stahl. 3 Funktionen.

Porte-Clés Multi Outils. Bois/ Acier Inox. 3 Fonctions.

Multitool Sleutelhanger. Hout/ Roestvrij Staal. 3 Functies.

6.1 x 2 x 1 cm 200/50
Print Code: D(1), L1



Polty 20190

Multitool Keyring. Wood/ Stainless Steel. 1 Led. 9 Functions. Button Batteries Included.

Multwerkzeug Schlüsselanhänger. Holz/ Rostfreier Stahl. 1 Led. 9 Funktionen. Knopfzellen Inklusief.

Porte-Clés Multi Outils. Bois/ Acier Inox. 1 Led. 9 Fonctions. Piles Bouton Incluses.

Multitool Sleutelhanger. Hout/ Roestvrij Staal. 1 Led. 9 Functies. Knoopcel Batterijen Inclusief.

2.7 x 5.5 x 2 cm 100/50
Print Code: D(1), L1



Meniok 20191

Multitool Keyring. Wood/ Stainless Steel. 7 Functions.

Multwerkzeug Schlüsselanhänger. Holz/ Rostfreier Stahl. 7 Funktionen.

Porte-Clés Multi Outils. Bois/ Acier Inox. 7 Fonctions.

Multitool Sleutelhanger. Hout/ Roestvrij Staal. 7 Functies.

3.5 x 7 x 1.5 cm 100/50
Print Code: D(1), L1



Axler 1m 21008

Tape Measure. Bamboo.

Maßband. Bambus.

Mètre Grade. Bambou.

Meetlint. Bamboe.

4.4 x 4.4 x 1.7 cm 400/100
Print Code: D(4), L1, W



Spiet 21010

Pocket Knife Keyring. Stainless Steel/ Wood.

Taschenmesser Schlüsselanhänger. Rostfreier Stahl/ Holz.

Porte-Clés Canif. Acier Inox/ Bois.

Zakmes Sleutelhanger. Roestvrij Staal/ Hout.

1.8 x 8 x 1 cm 200/50
Print Code: L1



Balmy 20192

Multitool Keyring. Bamboo/ Stainless Steel. 5 Functions.

Multwerkzeug Schlüsselanhänger. Bambus/ Rostfreier Stahl. 5 Funktionen.

Porte-Clés Multi Outils. Bambou/ Acier Inox. 5 Fonctions.

Multitool Sleutelhanger. Bamboe/ Roestvrij Staal. 5 Functies.

3 x 9.5 x 0.8 cm 200/100
Print Code: D(1), L1



Wilco 1m 20471

Multitool Tape Measure. Bamboo/ABS. 1 Led. 2 Accessoires. Button Batteries Included.
 Multiwerkzeug Maßband. Bambus/ABS. 1 Led. 2 Teile. Knopfzellen Inklusive.
 Mètre Grade Multi Outils. Bambou/ABS. 1 Led. 2 Accessoires. Piles Bouton Incluses.
 Multitool Meetlint. Bamboe/ABS. 1 Led. 2 Accessoires. Knoopcel Batterijen Inclusief.

Ø 5.8 x 1.9 cm 200 / 100 Print Code: D(1), L1



Lexi 21011

Multifunction Pen. Aluminium. 1 Accessorie. 5 Functions.
 Multifunktion Kugelschreiber. Aluminium. 1 Teil. 5 Funktionen.
 Stylo Multifonction. Aluminium. 1 Accessoire. 5 Fonctions.
 Multifunctioneel Pen. Aluminium. 1 Accessoire. 5 Functies.

Ø 1.1 x 9.2 cm 500 / 100 Print Code: D(1), L1



Kaizen 21000

Multifunction Keyring. Metal.
 Multifunktion Schlüsselanhänger. Metall.
 Porte-Clés Multifonction. Métal.
 Multifunctioneel Houder. Metaal.

2.3 x 6.2 x 0.7 cm 200 / 100 Print Code: D(1)



Liam 1m 1343

Opener Tape Measure.
 Flaschenöffner Maßband.
 Mètre Grade Ouvre Boutelle.
 Opener Meetlint.

4.5 x 4.5 x 1 cm 500 / 50 Print Code: D(4), W



Cimak 6697

Keyring Anticontact. Stylus Touch Ball Pen Included.
 Schlüsselanhänger Anticontact. Kugelschreiber Pointer Inklusive.
 Porte-Clés Anticontact. Stylé Bille Inclusive.
 Sleutelhanger Anticontact. Touch Bal Pen Inclusief.

3 x 7.3 x 0.5 cm 1000 / 50 Print Code: D(1)



Nish 20495

Multifunction Keyring. Bamboo.
 Multifunktion Schlüsselanhänger. Bambus.
 Porte-Clés Multifonction. Bambou.
 Multifunctioneel Houder. Bamboe.

6 x 8 x 1.5 cm 200 / 100 Print Code: D(4), L1



Special laser white light engraving

This item with an illuminated interior has an external coating specially designed for laser engraving, with which you will see your advertising or brand illuminated with white light. Ideal for pad printing too.



Eluxo 20983

Torch Keyring. 3 Led. Solar Charging. Battery 40 mAh.
Lampe Schlüsselanhänger. 3 Led. Solarladung. Batterie 40 mAh.
Porte-Clés Lampe. 3 Led. Charge Solaire. Batterie 40 mAh. Lampe. 1 Led. Piles Bouton Incluses.
Zaklamp Sleutelhanger. 3 Led. Zonnelading. Batterij 40 mAh. Zaklamp. 1 Led. Knoopcel Batterijen Inclusief.

3.5 x 6 x 1.2 cm 400 / 50
Print Code: C(1)



Bimox 5834

Torch. 1 Led. Button Batteries Included.

Lampe. 1 Led. Knopfzellen Inklusive.
Lampe. 1 Led. Piles Bouton Incluses.
Zaklamp. 1 Led. Knoopcel Batterijen Inclusief.

Ø 1.4 x 8.5 cm 500 / 50
Print Code: C(4), L1

Krujer 5035

Pen Torch. 1 Led. Button Batteries Included.
Kugelschreiber Lampe. 1 Led. Knopfzellen Inklusive.
Stylo Lampe. 1 Led. Piles Bouton Incluses.
Pen-Zaklamp. 1 Led. Knoopcel Batterijen Inclusief.

Ø 1 x 11 cm 500 / 50
Print Code: C(4)

Flonse 5207

Torch Keyring. 1 Led. Button Batteries Included.
Lampe Schlüsselanhänger. 1 Led. Knopfzellen Inklusive.
Porte-Clés Lampe. 1 Led. Piles Bouton Incluses.
Zaklamp Sleutelhanger. 1 Led. Knoopcel Batterijen Inclusief.

Ø 1.4 x 6.5 cm 1000 / 50
Print Code: C(4)



Rogla 20490

Torch. 3 Leds. Solar and Hand Charging. Button Batteries Included.
Lampe. 3 Leds. Solarladung und Dynamo. Knopfzellen Inklusive.
Lampe. 3 Leds. Charge Solaire et Manuel. Piles Bouton Incluses.
Zaklamp. 3 Leds. Zonnelading en Hand Oplaabaar. Zaklantaarn. Knoopcel Batterijen Inclusief.

5 x 9.2 x 3.3 cm 100 / 50
Print Code: D(1)

Conny 5331

Torch. Aluminium. 9 Leds. 3 Batteries AAA Not Included.
Lampe. Aluminium. 9 Leds. 3 AAA Batterien Nicht im Lieferumfang.
Lampe. Aluminium. 9 Leds. 3 Piles AAA Non Incluses.
Zaklamp. Aluminium. 9 Leds. 3 Batterijen AAA Niet Inclusief.

Ø 2.4 x 8.4 cm 200 / 50
Print Code: D(1), L1



Sufli 3484

Set. Aluminium/ Stainless Steel. Torch 1 Led. Pocket Knife 7 Functions. Button Batteries Included.
Set. Aluminium/ Rostfreier Stahl. Lampe 1 Led. Taschenmesser 7 Funktionen. Knopfzellen Inklusive.
Set. Aluminium/ Acier Inox. Lampe 1 Led. Canif 7 Fonctions. Piles Bouton Incluses.
Set. Aluminium/ Roestvrij Staal. Zaklamp 1 Led. Zakmes 7 Functies. Knoopcelbatterijen Inclusief.

13.5 x 2.7 x 9 cm 100 / 10
Print Code: E(1), L1



Vulko 1212

Torch Keyring. Bamboo. 1 Led. Button Batteries Included.
Lampe Schlüsselanhänger. Bambus. 1 Led. Knopfzellen Inklusive.
Porte-Clés Lampe. Bamboo. 1 Led. Piles Bouton Incluses.
Zaklamp Sleutelhanger. Bamboe. 1 Led. Knooppcel Batterijen Inclusief.

📏 Ø 1.5 x 6.5 cm 📦 1000 / 50 🖨️ Print Code: D(4), L1



Joper 21001

Torch Keyring. Bamboo. 1 Led. Button Batteries Included.
Lampe Schlüsselanhänger. Bambus. 1 Led. Knopfzellen Inklusive.
Porte-Clés Lampe. Bamboo. 1 Led. Piles Bouton Incluses.
Zaklamp Sleutelhanger. Bamboe. 1 Led. Knooppcel Batterijen Inclusief.

📏 Ø 1.5 x 7.5 cm 📦 1000 / 50 🖨️ Print Code: D(4), L1



Gus 20193

Torch. Bamboo. 3 Leds. Button Batteries Included.
Lampe. Bamboo. 3 Leds. Knopfzellen Inklusive.
Lampe. Bamboo. 3 Leds. Piles Bouton Incluses.
Zaklamp. Bamboe. 3 Leds. Knooppcel Batterijen Inclusief.

📏 Ø 3 x 6.6 cm 📦 400 / 100 🖨️ Print Code: D(4), L1



Wols 20985

Torch Keyring. Recycled Aluminium. 1 Led. Button Batteries Included.
Lampe Schlüsselanhänger. Recycling Aluminium. 1 Led. Knopfzellen Inklusive.
Porte-Clés Lampe. Aluminium Recyclé. 1 Led. Piles Bouton Incluses.
Zaklamp Sleutelhanger. Gerecycled Aluminium. 1 Led. Knooppcel Batterijen Inclusief.

📏 Ø 1.6 x 5.7 cm 📦 200 / 50 🖨️ Print Code: D(1), L1



Flareon 20984

Torch. Recycled Aluminium. 1 Led. 3 Batteries AAA Not Included.
Lampe. Recycling Aluminium. 1 Led. 3 AAA Batterien Nicht im Lieferumfang.
Lampe. Aluminium Recyclé. 1 Led. 3 Piles AAA Non Incluses.
Zaklamp. Gerecycled Aluminium. 1 Led. 3 Batterijen AAA Niet Inclusief.

📏 Ø 2.4 x 8.4 cm 📦 200 / 50 🖨️ Print Code: D(1), L1



Kushing 20986

Torch Keyring. Recycled Aluminium. 3 Leds. Button Batteries Included.
Lampe Schlüsselanhänger. Recycling Aluminium. 3 Leds. Knopfzellen Inklusive.
Porte-Clés Lampe. Aluminium Recyclé. 3 Leds. Piles Bouton Incluses.
Zaklamp Sleutelhanger. Gerecycled Aluminium. 3 Leds. Knooppcel Batterijen Inclusief.

📏 Ø 2.2 x 8.6 cm 📦 200 / 50 🖨️ Print Code: D(1), L1



Veterson 21074

Keyring. Wheat Straw/ ABS/ Bamboo.
Schlüsselanhänger. Weizenstroh/ ABS/ Bambus.
Porte-Clés. Paille de Blé/ ABS/ Bambou.
Steutelhanger. Tarwestro/ ABS/ Bamboe.

2 x 5.5 x 0.4 cm 2000 / 100
Print Code: C(4), L1



Peix 1911

Holder Keyring. Wheat Straw/ ABS. Screen Cleaner Included.
Schlüsselanhänger Halter. Weizenstroh/ ABS. Displayreiner Inklusive.
Porte-Clés Support. Paille de Blé/ ABS. Nettoyeur d'Écran Inclusif.
Steutelhanger Houder. Tarwestro/ ABS. Screen Cleaner Inclusief.

2 x 4.8 x 1.3 cm 1000 / 100
Print Code: C(4), W



Tasex 20231

Torch Keyring. Wheat Straw/ ABS. 1 Led. Button Batteries Included.
Lampe Schlüsselanhänger. Weizenstroh/ ABS. 1 Led. Knopfzellen Inklusive.
Porte-Clés Lampe. Paille de Blé/ ABS. 1 Led. Piles Bouton Incluses.
Zaklamp Sleutelhanger. Tarwestro/ ABS. 1 Led. Knoopcel Batterijen Inclusief.

2.4 x 6 x 0.8 cm 500 / 100
Print Code: C(4)



Evelyn 20232

Keyring Coin. Wheat Straw/ ABS. 2 Leds. Button Batteries Included.
Schlüsselanhänger EK-Chip. Weizenstroh/ ABS. 2 Leds. Knopfzellen Inklusive.
Porte-Clés Monnaie. Paille de Blé/ ABS. 2 Leds. Piles Bouton Incluses.
Munt-Sleutelhanger. Tarwestro/ ABS. 2 Leds. Knoopcelbatterijen Inclusief.

2.5 x 7 x 1 cm 500 / 100
Print Code: C(4)

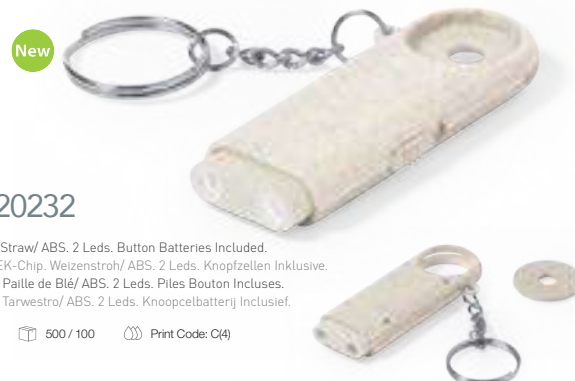

Prook 1910

Keyring Coin. Wheat Straw/ ABS.
Schlüsselanhänger EK-Chip. Weizenstroh/ ABS.
Porte-Clés Monnaie. Paille de Blé/ ABS.
Munt-Sleutelhanger. Tarwestro/ ABS.

2.8 x 5.1 x 0.4 cm 1000 / 100
Print Code: C(4)



Mecril 1909

Keyring Coin. Wheat Straw/ ABS.
Schlüsselanhänger EK-Chip. Weizenstroh/ ABS.
Porte-Clés Monnaie. Paille de Blé/ ABS.
Munt-Sleutelhanger. Tarwestro/ ABS.

3.1 x 6 x 0.2 cm 4000 / 500
Print Code: B(4)



Ucko 20418

Ice Scraper Keyring. Wheat Straw/ PS/ TPR.
Eiskratzer Schlüsselanhänger. Weizenstroh/ PS/ TPR.
Porte-Clés Gratte-Glace. Paille de Blé/ PS/ TPR.
Ijskrabber Sleutelhanger. Tarwestro/ PS/ TPR.

5 x 5.5 x 0.3 cm 500 / 100
Print Code: C(4)



Glasgol 1409

Multifunction Keyring. Wheat Straw/ ABS. Screen Cleaner Included.
Multifunktion Schlüsselanhänger. Weizenstroh/ ABS. Displayreiner Inklusive.
Porte-Clés Multifonction. Paille de Blé/ ABS. Nettoyeur d'Écran Inclusif.
Multifunctioneel Houder. Tarwestro/ ABS. Screen Cleaner Inclusief.

2.5 x 8.5 x 0.4 cm 1000 / 500
Print Code: C(4)



Fenrir 21057

Keyring: Metal/ Bamboo.
Schlüsselanhänger: Metall/ Bambus.
Porte-Clés: Métal/ Bambou.
Sleutelhanger: Metaal/ Bamboe.

Consult. 300 / 50 Print Code: D(1), L1



New

Zineth 21056

Keyring: Metal/ PU.
Schlüsselanhänger: Metall/ PU.
Porte-Clés: Métal/ PU.
Sleutelhanger: Metaal/ PU.

Consult. 300 / 50 Print Code: D(1), L1



New



Fostel 20188

Keyring: Recycled Leather/ Metal.
Schlüsselanhänger: Recycling Leder/ Metall.
Porte-Clés: Cuir Recyclé/ Métal.
Sleutelhanger: Gerecycled Leer/ Metaal.

Consult. 300 / 50 Print Code: D(1), L1



New



Hailton 21049

Keyring: Felt RPET/ Metal.
Schlüsselanhänger: Filz RPET/ Metall.
Porte-Clés: Feutrine RPET/ Métal.
Sleutelhanger: Vilt RPET/ Metaal.

Consult. 300 / 50 Print Code: D(1), N(6)



New

Dontex 1906

Keyring: Recycled Leather.
Schlüsselanhänger: Recycling Leder.
Porte-Clés: Cuir Recyclé.
Sleutelhanger: Gerecycled Leer.

4.8 x 5.7 x 0.4 cm 1000 / 100 Print Code: D(1), L1



Noemix 1907

Keyring: Recycled Leather.
Schlüsselanhänger: Recycling Leder.
Porte-Clés: Cuir Recyclé.
Sleutelhanger: Gerecycled Leer.

3 x 8.8 x 0.4 cm 1000 / 100 Print Code: D(1), L1



Triax 1899

Keyring: Felt RPET.
Schlüsselanhänger: Filz RPET.
Porte-Clés: Feutrine RPET.
Sleutelhanger: Vilt RPET.

3 x 10 cm 1000 / 50 Print Code: D(1), N(6)



Branis 1896

Keyring: Metal/ Polyester RPET.
Schlüsselanhänger: Metall/ Polyester RPET.
Porte-Clés: Métal/ Polyester RPET.
Sleutelhanger: Metaal/ Polyester RPET.

2.3 x 8.7 x 0.8 cm 500 / 50 Print Code: D(1), L1, N(6)





Pradim 21006

Keyring. Cotton/ Bamboo.
Schlüsselanhänger. Baumwolle/ Bambus.
Porte-Clés. Coton/ Bambou.
Sleutelhanger. Katoen/ Bamboe.

Ø 3,2 x 1 cm 1000 / 100 Print Code: D(1), L1



A - Ø 4 X 0,4 CM

Arixon 21003

Keyring. Metal/ Bamboo.
Schlüsselanhänger. Metal/ Bambus.
Porte-Clés. Métal/ Bambou.
Sleutelhanger. Metaal/ Bamboe.

Consult. 300 / 50 Print Code: D(4), L1



B - 3 X 4,2 X 0,4 CM



C - 4,5 X 4,5 X 0,2 CM

Sonek 6809

Keyring. Bamboo.
Schlüsselanhänger. Bambus.
Porte-Clés. Bambou.
Sleutelhanger. Bamboe.

Consult. 1000 / 100 Print Code: D(4), L1



A - Ø 5,5 X 0,2 CM



B - 3,9 X 5,9 X 0,2 CM



Maros 6796

Holder Keyring. Bamboo.
Schlüsselanhänger Halter. Bambus.
Porte-Clés Support. Bambou.
Sleutelhanger Houder. Bamboe.

2,6 x 6 x 1,5 cm 500 / 100 Print Code: D(4), L1, W



Zeke 1408

Holder Keyring. Bamboo.
Schlüsselanhänger Halter. Bambus.
Porte-Clés Support. Bambou.
Sleutelhanger Houder. Bamboe.

3,8 x 7,4 x 0,6 cm 1000 / 100 Print Code: C(4), L1



Evans 2618

Holder Keyring. Bamboo.
Schlüsselanhänger Halter. Bambus.
Porte-Clés Support. Bambou.
Sleutelhanger Houder. Bamboe.

2,5 x 8 x 0,3 cm 1600 / 400 Print Code: C(4), L1

Made in Europe



3,5 X 6,5 X 0,5 CM

D - 4 X 4 X 0,7 CM

ø4 X 0,5 CM

Selton 6186

Keyring. Wood.
Schlüsselanhänger. Holz.
Porte-Clés. Bois.
Sleutelhanger. Hout.

UNIQUE PIECES FROM NATURAL CUTS OF WOOD.
THE TEXTURE, COLOUR, SIZES AND THICKNESS MAY VARY.



Consult. 800 / 200 Print Code: D(4), L1

Pelton 6204

Keyring. Wood.
Schlüsselanhänger. Holz.
Porte-Clés. Bois.
Sleutelhanger. Hout.

A - Ø 3,9 X 0,7 CM, B - 3,2 X 5,1 X 0,7 CM,

Consult. 1000 / 100 Print Code: D(4), L1

Vitelok 5796

Keyring. Metal/ Wood.
Schlüsselanhänger. Metall/ Holz.
Porte-Clés. Métal/ Bois.
Sleutelhanger. Metaal/ Hout.

2,4 X 4,8 X 0,60 CM

Consult. 400 / 50 Print Code: D(4), L1



A
ø3,7 X 0,5M

B
2,9 X 5,5 X 0,5M

Mappets 1411

Keyring. Wood/ PU.
Schlüsselanhänger. Holz/ PU.
Porte-Clés. Bois/ Similicuir.
Sleutelhanger. Hout/ PU.

Consult. 1000 / 100
Print Code: D(4), L1

**Ranigang 1014**

Keyring. Metal/ Wood.
Schlüsselanhänger. Metall/ Holz.
Porte-Clés. Métal/ Bois.
Sleutelhanger. Metaal/ Hout.

2,5 x 7,5 x 0,7 cm 300 / 50
Print Code: D(4), L1



New

03

Recbam 21067

Keyring. Bamboo.
Schlüsselanhänger. Bambus.
Porte-Clés. Bambou.
Sleutelhanger. Bamboe.

3 x 5,5 x 0,2 cm 1000 / 100
Print Code: D(4), L1



New

19

Cirbam 21066

Keyring. Bamboo.
Schlüsselanhänger. Bambus.
Porte-Clés. Bambou.
Sleutelhanger. Bamboe.

ø 4 x 0,2 cm 1000 / 100 Print Code: D(4), L1

NATURAL
CORK

4 X 6 X 0.6 CM



B

Kimbox 6205

Keyring. Cork.
Schlüsselanhänger. Kork.
Porte-Clés. Liège.
Sleutelhanger. Kurk.

Consult. 1000 / 100 Print Code: D(1), L1



A

Ø 5 X 0,6 CM

**Branko 6486**

Keyring. Cork/ Metal.
Schlüsselanhänger. Kork/ Metall.
Porte-Clés. Liège/ Métal.
Sleutelhanger. Kurk/ Staal.

2.7 x 10.5 x 0.7 cm 500 / 50 Print Code: D(1), L1



FLOATING KEYRING

**Cruffid 1026**

Keyring. Cork.
Schlüsselanhänger. Kork.
Porte-Clés. Liège.
Sleutelhanger. Kurk.

4 x 9 x 1.5 cm 500 / 100 Print Code: D(1), L1

**Telsox 6015**

Keyring. Cork.
Schlüsselanhänger. Kork.
Porte-Clés. Liège.
Sleutelhanger. Kurk.

Ø 2.3 x 4.4 cm 1000 / 50 Print Code: D(1), L1

Wilbut 1475

Torch Keyring. Cork. 1 Led. Button Batteries Included.
Lampe Schlüsselanhänger. Kork. 1 Led. Knopfzellen inklusive.
Porte-Clés Lampe. Liège. 1 Led. Piles Bouton Incluses.
Zaklamp Sleutelhanger. Kurk. 1 Led. Knoopcel Batterijen Inclusief.

4.5 x 6 x 0.9 cm 500 / 100 Print Code: D(1), L1



05



03

02

19

01

Boriem 5655

Keyring. Metal/ PU.
Schlüsselanhänger. Metall/ PU.
Porte-Clés. Métal/ Similicuir.
Sleutelhanger. Metaal/ PU.

2.5 x 8 x 1 cm

200 / 50

Print Code: D(1), L1



02



19

18

01

04

03

Pelcu 3724

Keyring. PU.
Schlüsselanhänger. PU.
Porte-Clés. Similicuir.
Sleutelhanger. PU.

 3.8 x 5.5 x 0.7 cm
 Print Code: D(1), L1

1000 / 100



New

01

02

17

06

Greip 21005

Keyring. PU.
Schlüsselanhänger. PU.
Porte-Clés. Similicuir.
Sleutelhanger. PU.

 8 x 11.2 x 0.3 cm
 Print Code: D(1), L1

1000 / 100



06



01

Vinger 4034

Keyring. Metal/ Polyester.
Schlüsselanhänger. Metall/ Polyester.
Porte-Clés. Métal/ Polyester.
Sleutelhanger. Metaal/ Polyester.

3.2 x 6 x 0.6 cm

300 / 50

Print Code: D(1), L1



02

19

Motok 5102

Keyring Purse. Polyester 600D.
Schlüsselanhänger Portemonnaie. Polyester 600D.
Porte-Clés Porte Monnaie. Polyester 600D.
Sleutelhanger-Tasje. Polyester 600D.

6 x 10.5 x 0.7 cm

500 / 10

Print Code: N(8)



03



04

Recycled Aluminium



New



Fique 21124

Holder Keyring. Recycled Aluminium.
Schlüsselanhänger Halter. Recycling Aluminium.
Porte-Clés Support. Aluminium Recyclé.
Sleutelhanger Houder. Gerecycled Aluminium.

1.9 x 5.7 x 1.9 cm 1000 / 100 Print Code: D(1), L1



09

NEW COLOR



Talgun 1378

Keyring Coin. Recycled Aluminium.
Schlüsselanhänger EK-Chip. Recycling Aluminium.
Porte-Clés Monnaie. Aluminium Recyclé.
Munt-Sleutelhanger. Gerecycled Aluminium.

2.3 x 6.7 x 0.1 cm 2000 / 100 Print Code: D(4), L1



Lofly 1379

Keyring. Recycled Aluminium/ Polyester.
Schlüsselanhänger. Recycling Aluminium/ Polyester.
Porte-Clés. Aluminium Recyclé/ Polyester.
Sleutelhanger. Gerecycled Aluminium/ Polyester.

2.8 x 6.5 x 0.6 cm 500 / 50 Print Code: D(4), L1



Mailtek 1376

Keyring. Recycled Aluminium.
Schlüsselanhänger. Recycling Aluminium.
Porte-Clés. Aluminium Recyclé.
Sleutelhanger. Gerecycled Aluminium.

2.9 x 5.4 x 0.1 cm 2000 / 100 Print Code: D(4), L1



Galindex 1375

Carabiner. Recycled Aluminium.
Karabiner. Recycling Aluminium.
Mousqueton. Aluminium Recyclé.
Karabijnhaak. Gerecycled Aluminium.

3.1 x 6 x 0.5 cm 1000 / 200 Print Code: D(1), L1



Sontiol 1377

Keyring. Recycled Aluminium/ Polyester.
Schlüsselanhänger. Recycling Aluminium/ Polyester.
Porte-Clés. Aluminium Recyclé/ Polyester.
Sleutelhanger. Gerecycled Aluminium/ Polyester.

2.5 x 5.5 x 0.6 cm 500 / 50 Print Code: D(4), L1



Cyrax 1915

Keyring, Metal/ Cotton.
Schlüsselanhänger, Metall/ Baumwolle.
Porte-Clés, Métal/ Coton.
Steutelhanger, Metaal/ Katoen.

2.8 x 6.5 x 0.6 cm 300 / 50 Print Code: L1



Rhedon 1396

Keyring, Metal/ Cork.
Schlüsselanhänger, Metall/ Kork.
Porte-Clés, Métal/ Liège.
Steutelhanger, Metaal/ Kurk.

2.8 x 6.5 x 0.6 cm 300 / 50 Print Code: D(4), L1



Yip 9274

Keyring, Metal/ Polyester.
Schlüsselanhänger, Metall/ Polyester.
Porte-Clés, Métal/ Polyester.
Steutelhanger, Metaal/ Polyester.

2.8 x 6.5 x 0.6 cm 300 / 50
Print Code: D(4), L1



NEW
COLORS



03

Dagor 4442

Keyring, Metal/ Polyester.
Schlüsselanhänger, Metall/ Polyester.
Porte-Clés, Métal/ Polyester.
Steutelhanger, Metaal/ Polyester.

2.7 x 6 x 0.6 cm 300 / 50 Print Code: L1, V



19



Persal 4978

Keyring, Stainless Steel.
Schlüsselanhänger, Rostfreier Stahl.
Porte-Clés, Acier Inox.
Steutelhanger, Roestvrij Staal.

2.9 x 4 x 0.4 cm 200 / 50 Print Code: D(1), L1

for
doming



Inoki 21002

Keyring Coin. Bamboo.
Schlüsselanhänger EK-Chip. Bambus.
Porte-Clés Monnaie. Bambou.
Munt-Sleutelhanger. Bamboe.

📏 2.3 x 6 cm 📦 1000 / 100 🖨️ Print Code: D(1), L1



Euromarket 3298

Keyring Coin. Metal.
Schlüsselanhänger EK-Chip. Metall.
Porte-Clés Monnaie. Métal.
Munt-Sleutelhanger. Metaal.

📏 2.3 x 6 cm 📦 1000 / 100 🖨️ Print Code: D(1)



Hoinzo 4979

Keyring Coin. Metal.
Schlüsselanhänger EK-Chip. Metall.
Porte-Clés Monnaie. Métal.
Munt-Sleutelhanger. Metaal.

📏 Consult. 📦 200 / 50 🖨️ Print Code: D(1), L1



Deneb 21007

Hip Flask Keyring. Stainless Steel. 30 ml.
Schlüsselanhänger Flachmann. Rostfreier Stahl. 30 ml.
Porte-Clés Flacon. Acier Inox. 30 ml.
Fles Sleutelhanger. Roestvrij Staal. 30 ml.

📏 4.1 x 5.7 x 2 cm 📦 400 / 100 🖨️ Print Code: D(4), L1



Alumpill 3168

Keyring Pillbox. Aluminium. 1 Compartment.
Schlüsselanhänger Pillendose. Aluminium. 1 Abteilung.
Porte-Clés Piluliere. Aluminium. 1 Compartment.
Sleutelhanger Pillendoosje. Aluminium. 1 Compartment.

📏 1.4 x 5.2 cm 📦 500 / 50 🖨️ Print Code: D(1), L1



Trailer 9272

Keyring. Metal.
Schlüsselanhänger. Metall.
Porte-Clés. Métal.
Sleutelhanger. Metaal.

📏 2.9 x 7.5 x 0.3 cm 📦 400 / 50 🖨️ Print Code: D(1), L1



Rader 5358

Keyring. Stainless Steel.
Schlüsselanhänger. Rostfreier Stahl.
Porte-Clés. Acier Inox.
Sleutelhanger. Roestvrij Staal.

4.2 × 3 × 0.4 cm 300 / 50 Print Code: D(1), L1



Engine 9642

Keyring. Metal.
Schlüsselanhänger. Metall.
Porte-Clés. Métal.
Sleutelhanger. Metaal.

4.3 × 3 × 0.5 cm 400 / 50 Print Code: D(1), L1



Fangiox 21004

Keyring. Metal/ Bamboo.
Schlüsselanhänger. Metall/ Bambus.
Porte-Clés. Métal/ Bambou.
Sleutelhanger. Metaal/ Bamboe.

2.4 × 5 × 0.4 cm 200 / 50 Print Code: D(1), L1



Zosin 6061

Keyring. Stainless Steel.
Schlüsselanhänger. Rostfreier Stahl.
Porte-Clés. Acier Inox.
Sleutelhanger. Roestvrij Staal.

4.2 × 3.7 × 0.4 cm 400 / 100 Print Code: D(1), L1



Amuni 21012

Keyring. Cork.
Schlüsselanhänger. Kork.
Porte-Clés. Liège.
Sleutelhanger. Kurk.

5.4 × 4.7 × 0.7 cm 1000 / 100
Print Code: D(1), L1



Cutum 1025

Keyring. Metal/ Bamboo.
Schlüsselanhänger. Metall/ Bambus.
Porte-Clés. Métal/ Bambou.
Sleutelhanger. Metaal/ Bamboe.

4.4 × 4.3 × 0.4 cm 200 / 50 Print Code: D(1), L1



05

Zoko 3857

Carabiner, Aluminium.
Karabiner, Aluminium.
Mousqueton, Aluminium.
Karabijnhaak, Aluminium.

3 x 6 x 0.5 cm 1000 / 200 Print Code: D(1), L1



11

Nevek 4207

Keyring, Aluminium.
Schlüsselanhänger, Aluminium.
Porte-Clés, Aluminium.
Sleutelhanger, Aluminium.

2.9 x 5.4 x 0.1 cm 1000 / 100 Print Code: D(4), L1



02

09

03

19

04



03

02

09

19

02

09

03

19

02

03

09

19

Singe 3900

Opener Keyring, Aluminium.
Schlüsselanhänger Flaschenöffner, Aluminium.
Porte-Clés Ouvre Bouteille, Aluminium.
Sleutelhanger Opener, Aluminium.

2.7 x 7.5 x 0.3 cm 800 / 200 Print Code: D(4), L1

Blicher 5627

Opener Keyring, Aluminium.
Schlüsselanhänger Flaschenöffner, Aluminium.
Porte-Clés Ouvre Bouteille, Aluminium.
Sleutelhanger Opener, Aluminium.

3 x 6.6 x 0.4 cm 1000 / 200 Print Code: D(4), L1

Ciclex 4589

Keyring, Aluminium.
Schlüsselanhänger, Aluminium.
Porte-Clés, Aluminium.
Sleutelhanger, Aluminium.

3.5 x 5.7 x 0.4 cm 1000 / 200 Print Code: D(1), L1



Samo 3911

Opener Keyring. Aluminium.
Schlüsselanhänger Flaschenöffner. Aluminium.
Porte-Clés Ouvre Bouteille. Aluminium.
Sleutelhanger Opener. Aluminium.

1.1 × 6.7 × 1.5 cm 1000 / 200 Print Code: D(4), L1



Mixe 1908

Opener Keyring. Recycled Aluminium.
Schlüsselanhänger Flaschenöffner. Recycling Aluminium.
Porte-Clés Ouvre Bouteille. Aluminium Recyclé.
Sleutelhanger Opener. Gerecycled Aluminium.

1.1 × 6 × 1.5 cm 1000 / 100 Print Code: D(4), L1



Stiked 6446

Opener Keyring. Aluminium.
Schlüsselanhänger Flaschenöffner. Aluminium.
Porte-Clés Ouvre Bouteille. Aluminium.
Sleutelhanger Opener. Aluminium.

1.1 × 6 × 1.5 cm 1000 / 100 Print Code: D(4), L1



Delfis 1208

Multifunction Keyring. Aluminium.
Multifunktion Schlüsselanhänger. Aluminium.
Porte-Clés Multifonction. Aluminium.
Multifunctioneel Houder. Aluminium.

1.2 × 6.2 × 1.5 cm 1000 / 100 Print Code: D(4), L1



Milter 5500

Opener Keyring. Aluminium.
Schlüsselanhänger Flaschenöffner. Aluminium.
Porte-Clés Ouvre Bouteille. Aluminium.
Sleutelhanger Opener. Aluminium.

0.9 × 7.9 × 1.5 cm 1000 / 200 Print Code: D(4), L1



Clevon 6058

Opener Keyring. Aluminium.
Schlüsselanhänger Flaschenöffner. Aluminium.
Porte-Clés Ouvre Bouteille. Aluminium.
Sleutelhanger Opener. Aluminium.

3 × 8.9 × 0.2 cm 1000 / 100 Print Code: D(4), L1



Skype 9416

Foldable Bag Hanger: Metal/ PU.
 Faltbarer Handtaschenhalter: Metall/ PU.
 Porte-Sac Pliable: Métal/ Similicuir.
 Opvouwbare Tassenhanger: Metaal/ PU.

3.3 x 8 cm 200 / 100 Print Code: D(4), L1



Tofin 6488

Keyring: Metal/ Polyester.
 Schlüsselanhänger: Metall/ Polyester.
 Porte-Clés: Métal/ Polyester.
 Sleutelhanger: Metaal/ Polyester.

2.5 x 12 x 0.2 cm 1000 / 100 Print Code: D(1), N(8), R



19



Soke 3583

Keyring: EVA.
 Schlüsselanhänger: EVA.
 Porte-Clés: EVA.
 Sleutelhanger: EVA.

3.3 x 6.8 x 1.4 cm 1000 / 50 Print Code: E(1)



FLOATING KEYRING

19



Perle 3914

Keyring: EVA.
 Schlüsselanhänger: EVA.
 Porte-Clés: EVA.
 Sleutelhanger: EVA.

3.3 x 8 x 2.3 cm 1000 / 50 Print Code: D(1)



03

Koreflec 5659

Keyring: PVC, Reflective.
 Schlüsselanhänger: PVC, Reflektierend.
 Porte-Clés: PVC, Réfléchissant.
 Sleutelhanger: PVC, Reflecterend.

6.1 x 5.3 x 0.2 cm 1000 / 100 Print Code: C(4)



05



09

ANTISTRESS



Boltex 5645

Mandala Set, Cardboard, 12 Pencils and 12 Sheets Included.
Mandala Set, Pappe, 12 Stifte und 12 Seiten Inklusive.
Set Mandala, Carton, 12 Crayons et 12 Feuilles Incluses.
Mandata Set, Karton, 12 Potlooden en 12 Blaadjes Inclusief.

9 × 9 × 1 cm 300 / 20 Print Code: B(4), W



Bover 20976

Antistress, Bamboe, Magnetic.
Antistress, Bambus, Magnetisch.
Antistress, Bamboe, Magnétique.
Antistress, Bamboe, Magnëtisch.

4,5 × 1,2 × 2,5 cm 500 / 100
Print Code: C(4), L1, W



Eline 20977

Antistress, 4 Pieces, Magnetic, Polyester RPET Pouch.
Antistress, 4 Stück, Magnetisch, Polyester RPET Etui.
Antistress, 4 Pièces, Magnétique, Étui Polyester RPET.
Antistress, 4 Stuks, Magnetisch, Polyester RPET Zakje.

8 × 12 × 1,5 cm 200 / 50 Print Code: F(1), N(8)

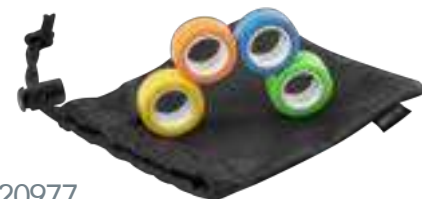



Tute 1023

Spanish Playing Cards. 50 Cards.
Spanisches Kartenspiel. 50 Karten.
Jeu de Cartes Espagnol. 50 Cartes.
Spaanse Kaartspel. 50 Kaarten.

7.8 x 10 x 2.2 cm 100 / 10 Print Code: E(1)



Picas 1022

Poker Playing Cards. 54 Cards.
Französisches Kartenspiel. 54 Karten.
Jeu de Cartes Français. 54 Cartes.
Franse Kaartspel. 54 Kaarten.

7.8 x 10 x 2.2 cm 100 / 10 Print Code: E(1)



Brisca 20980

Spanish Playing Cards. Recycled Cardboard. 50 Cards.
Spanisches Kartenspiel. Recycling Pappé. 50 Karten.
Jeu de Cartes Espagnol. Carton Recyclé. 50 Cartes.
Spaanse Kaartspel. Gerecycled Karton. 50 Kaarten.

5.5 x 8.5 x 1.8 cm 200 / 50 Print Code: D(1)

Kardain 20981

Set Playing Cards. Recycled Cardboard. Spanish Deck 50 Cards. French Deck 54 Cards.
Kartenspiel Set. Recycling Pappé. Spanisches Kartenspiel 50 Karten. Französisches
Kartenspiel 54 Karten.

Set Jeu de Cartes. Carton Recyclé. Jeu de Cartes Espagnol 50 cartes. Jeu de Cartes
Français 54 cartes.
Kaartspel Set. Gerecycled Karton. Spaans Kaartspel 50 Kaarten. Franse Kaartspel 54
Kaarten.

13.5 x 2.5 x 9.5 cm 80 / 40 Print Code: D(1)

Trebol 1021

Poker Playing Cards. Recycled Cardboard. 54 Cards.
Französisches Kartenspiel. Recycling Pappé. 54 Karten.
Jeu de Cartes Français. Carton Recyclé. 54 Cartes.
Franse Kaartspel. Gerecycled Karton. 54 Kaarten.

5.5 x 8.5 x 1.8 cm 200 / 50 Print Code: D(1)



Atanin 20982

Game. Wood. 5 Pieces.
Spiel. Holz. 5 Stück.
Jeu. Bois. 5 Pièces.
Spel. Hout. 5 Stuks.

Print Code: D(4), L1, W



Pelkat 6418

Game Set. Wood. 2 Games.
Spiel Set. Holz. 2 Spiele.
Set Jeu. Bois. 2 Jeux.
Spel Set. Hout. 2 Spelen.

Print Code: D(2), L2, W



Halin 6933

Game Set. Wood. 2 Games.
Spiel Set. Holz. 2 Spiele.
Set Jeu. Bois. 2 Jeux.
Spel Set. Hout. 2 Spelen.

Print Code: D(2), L2, W



Landers 1027

Dominoes. Bamboo. 28 Pieces.
Domino. Bambus. 28 Stück.
Dominos. Bambou. 28 Pièces.
Domino. Bamboe. 28 Stuks.

Print Code: D(2), L2, W



Prakon 6112

Dominoes. Wood. 28 Pieces.
Domino. Holz. 28 Stück.
Dominos. Bois. 28 Pièces.
Domino. Hout. 28 Stuks.

Print Code: D(2), L2, W





Blitz 1914

Chess. Wood. 32 Pieces.
Schach. Holz. 32 Stück.
Échecs. Bois. 32 Pièces.
Schaken. Hout. 32 Stuks.

21 x 2.5 x 10.5 cm 100 / 50 Print Code: D(2), L2



Xigral 6113

Game Set. Wood. 4 Games.
Spiel Set. Holz. 4 Spiele.
Set Jeu. Bois. 4 Jeux.
Spel Set. Hout. 4 Spelen.

CHES, DRAUGHTS,
DOMINOES AND MIKADO

16.3 x 3 x 16.3 cm 50 Print Code: D(2), L2, W



Parchess 6932

Game Set. Wood. 3 Games.
Spiel Set. Holz. 3 Spiele.
Set Jeu. Bois. 3 Jeux.
Spel Set. Hout. 3 Spelen.

12.5 x 3 x 12.5 cm 100 / 50 Print Code: D(2), L2, W



Grpex 6417

Game. Wood. 9 Pieces.
Spiel. Holz. 9 Stück.
Jeu. Bois. 9 Pièces.
Spel. Hout. 9 Stuks.

7.3 x 3.1 x 7.3 cm 200 / 50 Print Code: D(2), L2, W



CORK PIECES

Fornot 20161

Game. Cork. 10 Pieces. Cotton Pouch.
Spiel. Kork. 10 Stück. Baumwolle Etui.
Jeu. Liège. 10 Pièces. Étui Coton.
Spel. Kurk. 10 Stuks. Katoen Zakje.

12.5 x 15.5 cm 200 / 50 Print Code: B(1), E(1), L1, N(6)



Crested 20383

Skill Game. Wood. 16 Pieces.
Geschicklichkeitsspiel. Holz. 16 Stück.
Jeu d' "Habileté. Bois. 16 Pièces.
Behendigheidsspel. Hout. 16 Stuks.

8.6 x 3 x 8.6 cm 100 / 50 Print Code: D(2), L1, W

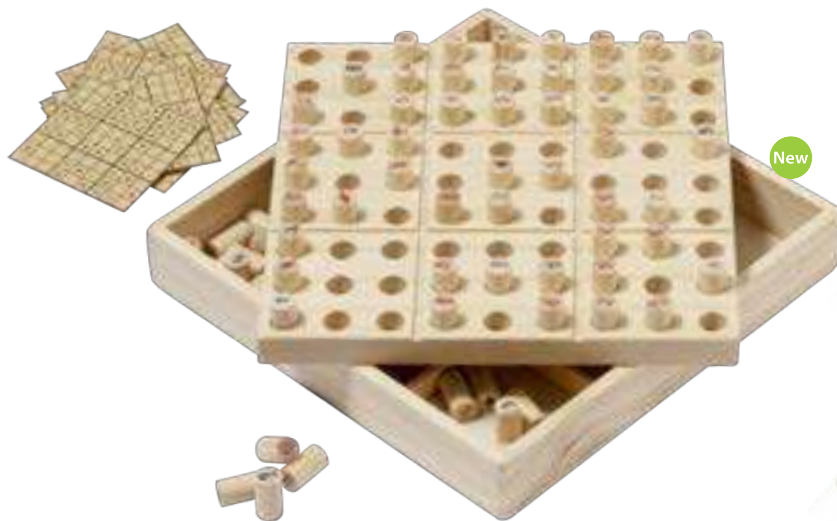

Sudoku 20189

Skill Game. Wood. 81 Pieces.
Geschicklichkeitsspiel. Holz. 81 Stück.
Jeu d' "Habileté. Bois. 81 Pièces.
Behendigheidsspel. Hout. 81 Stuks.

20 x 3.5 x 20 cm 30 Print Code: D(2), L2, W



Thumper 20403

Game. Wood. 17 Pieces. Cotton Pouch.
Spiel. Holz. 17 Stück. Baumwolle Etui.
Jeu. Bois. 17 Pièces. Étui Coton.
Spel. Hout. 17 Stuks. Katoen Zakje.

12 x 12 x 1.5 cm 100 / 50 Print Code: D(2), E(1), L1, N(6)



Sabix 6419

Game. Wood. 45 Pieces. Cotton Pouch.
Spiel. Holz. 45 Stück. Baumwolle Etui.
Jeu. Bois. 45 Pièces. Étui Coton.
Spel. Hout. 45 Stuks. Katoen Zakje.

8x11.5 5.7 x 17 x 5.7 cm 50
Print Code: G(1), N(8), L1



Ketel 1506

Skill Game. Wood. 4 Pieces. Cotton Pouch.
Geschicklichkeitsspiel. Holz. 4 Stück. Baumwolle Etui.
Jeu d'«Habilité». Bois. 4 Pièces. Étui Coton.
Behendigheidsspel. Hout. 4 Stuks. Katoen Zakje.

9x12 9 x 12 cm 200 / 50
Print Code: G(1), L2, N(8)



Facon 5903

Skill Games Set. Metal. 4 Games. Polyester Pouch.
Geschicklichkeitsspiele Set. Metall. 4 Spiele. Polyester Etui.
Set Jeux d'«Habilités». Métal. 4 Jeux. Étui Polyester.
Behendigheidsspel Set. Metaal. 4 Spelen. Polyester Zakje.

8x11.5 8 x 11.5 x 1 cm 200 / 50
Print Code: F(1), N(8)



Charlis 1507

Skill Game. Wood. 13 Pieces.
Geschicklichkeitsspiel. Holz. 13 Stück.
Jeu d'«Habilité». Bois. 13 Pièces.
Behendigheidsspel. Hout. 13 Stuks.

14.4x3 14.4 x 3 x 14.4 cm 40
Print Code: D(2), L2, W



Mikado 5718

Skill Game. Wood. 41 Pieces.
Geschicklichkeitsspiel. Holz. 41 Stück.
Jeu d'«Habilité». Bois. 41 Pièces.
Behendigheidsspel. Hout. 41 Stuks.

19.3x2.5 19.3 x 2.5 x 4.1 cm 100 / 50
Print Code: D(2), L2, W

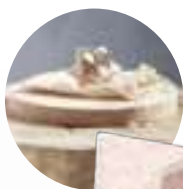

Bruffy 6781

Skill Game. Wood. 6 Pieces. Cotton Pouch.
Geschicklichkeitsspiel. Holz. 6 Stück. Baumwolle Etui.
Jeu d' 'Habilité. Bois. 6 Pièces. Étui Coton.
Behendigheidsspel. Hout. 6 Stuks. Katoen Zakje.

📏 5 x 5 x 5 cm 📦 200 / 100 🗑️ Print Code: G(1), N(8)



Tayex 6782

Skill Game. Wood. 7 Pieces. Cotton Pouch.
Geschicklichkeitsspiel. Holz. 7 Stück. Baumwolle Etui.
Jeu d' 'Habilité. Bois. 7 Pièces. Étui Coton.
Behendigheidsspel. Hout. 7 Stuks. Katoen Zakje.

📏 4.5 x 4.5 x 4.5 cm 📦 200 / 100 🗑️ Print Code: G(1), N(8)

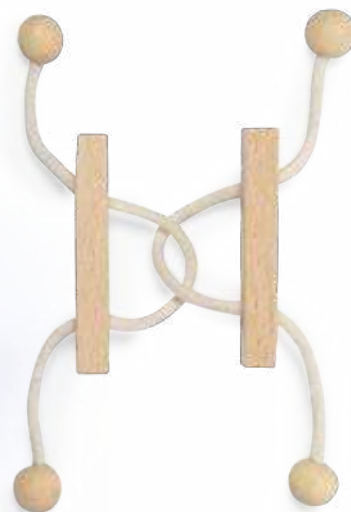

Griffon 20396

Skill Game. Wood.
Geschicklichkeitsspiel. Holz.
Jeu d' 'Habilité. Bois.
Behendigheidsspel. Hout.

📏 5.7 x 3.8 x 2.3 cm 📦 500 / 100 🗑️ Print Code: C(1), L1



Genium 5525

Skill Games Set. Wood. 3 Games.
Geschicklichkeitsspiele Set. Holz. 3 Spiele.
Set Jeux d' 'Habilités. Bois. 3 Jeux.
Behendigheidsspel Set. Hout. 3 Spelen.

📏 16.3 x 6 x 6.4 cm 📦 50 🗑️ Print Code: D(2), L2, W



Milie 1521

Skill Game. Wood. Cotton Pouch.
Geschicklichkeitsspiel. Holz. Baumwolle Etui.
Jeu d' 'Habilité. Bois. Étui Coton.
Behendigheidsspel. Hout. Katoen Zakje.

📏 11.1 x 4.7 x 5.2 cm 📦 100 / 50 🗑️ Print Code: G(1), L2, N(8)



Cusack 20395

Skill Game. Bamboo. 6 Pieces.
Geschicklichkeitsspiel. Bambus. 6 Stück.
Jeu d' 'Habilité. Bambou. 6 Pièces.
Behendigheidsspel. Bamboe. 6 Stuks.

📏 4.5 x 4.5 x 4.5 cm 📦 500 / 100 🗑️ Print Code: C(1)





Boliche 1913

Game Petanque. Metal. 8 Pieces. Polyester RPET Pouch.
 Spiel Petanque. Metall. 8 Stück. Polyester RPET Etui.
 Jeu Pétanque. Métal. 8 Pièces. Étui Polyester RPET.
 Spel Petanque. Metaal. 8 Stuks. Polyester RPET Zakje.

23 x 8 x 16.5 cm 2 Print Code: H(1), N(8)

New



Delero 20979

Game Petanque. Wood. 8 Pieces. Cotton Pouch.
 Spiel Petanque. Holz. 8 Stück. Baumwolle Etui.
 Jeu Pétanque. Bois. 8 Pièces. Étui Coton.
 Spel Petanque. Hout. 8 Stuks. Katoen Zakje.

20 x 29.5 x 7 cm 15 Print Code: G(1), N(8)



New

Madis 20404

Game. Wood. 5 Pieces.
 Spiel. Holz. 5 Stück.
 Jeu. Bois. 5 Pièces.
 Spel. Hout. 5 Stuks.

37 x 7 x 10 cm 20 Print Code: E(1), L2



Tumble 1505

Game. Wood. 4 Pieces.
 Spiel. Holz. 4 Stück.
 Jeu. Bois. 4 Pièces.
 Spel. Hout. 4 Stuks.

18 x 10 x 7.7 cm 50 Print Code: D(4), L2, W



Strike 1342

Minigame Bowling. Wood.
 Mini-Spiel Bowling. Holz.
 Mini-Jeu Bowling. Bois.
 Minispiel Bowling. Hout.

30 x 4.5 x 10 cm 20 Print Code: G(1), L2





Kazama 1511

Game. Wood. 21 Pieces. Cotton Pouch.
 Spiel. Holz. 21 Stück. Baumwolle Etui.
 Jeu. Bois. 21 Pièces. Étui Coton.
 Spel. Hout. 21 Stuks. Katoen Zakje.

35 x 34 cm 8 Print Code: G(1), N(8)



Spare 1512

Game Skittles. Wood. 12 Pieces. Cotton Pouch.
 Spiel Bowling. Holz. 12 Stück. Baumwolle Etui.
 Jeu Bowling. Bois. 12 Pièces. Étui Coton.
 Spel Bowling. Hout. 12 Stuks. Katoen Zakje.

32 x 34 cm 8 Print Code: G(1), L2, N(8)



Helmet 1483

Mini Table Football. Wood/ Wheat Straw/ PS. 2 Balls Included.
 Mini Kicker. Holz/ Weizenstroh/ PS. 2 Bälle Inklusiv.
 Mini Babyfoot. Bois/ Paille de Blé/ PS. 2 Balles Incluses.
 Mini Tafelvoetbal. Hout/ Tarwestro/ PS. 2 Ballen Inclusief.

36.5 x 9.5 x 32 cm 5 Print Code: K(1)



Wolven 20405

Game. Wood. 10 Pieces.
 Spiel. Holz. 10 Stück.
 Jeu. Bois. 10 Pièces.
 Spel. Hout. 10 Stuks.

34.5 x 2.3 x 21.5 cm 20 Print Code: E(2), L2

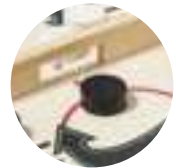

New

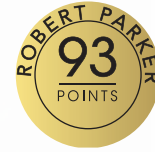

SPAIN 

La Montesa 6353

Bottle of Red Wine. 750 ml.
Flasche Rotwein. 750 ml.
Bouteille de Vin Rouge. 750 ml.
Fles Rode Wijn. 750 ml.

 Ø 8.5 x 30 cm  12  Print Code: Consultar



SPAIN 

Solar Viejo 6042

Bottle of Red Wine. 750 ml.
Flasche Rotwein. 750 ml.
Bouteille de Vin Rouge. 750 ml.
Fles Rode Wijn. 750 ml.

 Ø 7 x 32 cm  6  Print Code: Consultar



SPAIN 

Orube 6031

Bottle of White Wine. 750 ml.
Flasche Weißwein. 750 ml.
Bouteille de Vin Blanc. 750 ml.
Fles Witte Wijn. 750 ml.

 Ø 8 x 30 cm  6  Print Code: Consultar



SPAIN 🇪🇸

Golden 2662

Olive Oil Premium Set. Glass, 3 Pieces 250 ml. Picual and Arbequina Oil.
Olivenöl Premium Set. Glas, 3 Stück 250 ml. Öl Picual und Arbequina.
Set Huile d'olive. Verre, 3 Pièces 250 ml. Huile Picual et Arbequina.
Olijfolie Premium Set. Glas, 3 Stuks 250 ml. Olie Picual en Arbequina.

📏 19 x 5.5 x 25.2 cm 📦 4 🖨️ Print Code: E(1)

CONSULT PRICE



SPAIN 🇪🇸

Golden 500 ml 2661

Olive Oil Premium. Glass. Picual Oil.
Olivenöl Premium. Glas. Öl Picual.
Huile d'olive Premium. Verre. Huile Picual.
Olijfolie Premium. Glas. Olie Picual.

📏 Ø 6.5 x 30.5 cm 📦 10 🖨️ Print Code: E(1)

CONSULT PRICE

18 PERSONAL CARE & WELLNESS





DERMATOLOGICALLY
TESTED100%
VEGAN

New

**Maltix 20140**

Vegan Lip Balm. Aluminium. SPF15. Vanilla Aroma.
 Veganer Lippenbalsam. Aluminium. SPF15. Vanille Aroma.
 Baume Lèvres Végane. Aluminium. SPF15. Arôme Vanille.
 Veganistische Lippenbalsem. Aluminium. SPF15. Vanille Aroma.

Ø 4.1 x 1.7 cm 500 / 50 Print Code: C(1), L1, W



01

02

22

Posie 20570

Vegan Lip Balm. SPF15. Vanilla Aroma.
 Veganer Lippenbalsam. SPF15. Vanille Aroma.
 Baume Lèvres Végane. SPF15. Arôme Vanille.
 Veganistische Lippenbalsem. SPF15. Vanille Aroma.

Ø 1.9 x 7 cm 500 / 25 Print Code: C(4)



New

21

Taishe 1665

Lip Balm. Aloe Vera Aroma.
 Lippenbalsam. Aloe Vera Aroma.
 Baume Lèvres. Arôme Aloe Vera.
 Lippenbalsem. Aloe Vera Aroma.

Ø 1.9 x 7 cm 500 / 25 Print Code: C(4)

DERMATOLOGICALLY
TESTED100%
VEGAN



Dermatologically Tested

BAMBOO FIBRE



Fledar 6447

Lip Balm. Bamboo Fibre/ ABS. SPF15. Vanilla Aroma.
 Lippenbalsam. Bambusfaser/ ABS. SPF15. Vanille Aroma.
 Baume Lèvres. Fibre Bambou/ ABS. SPF15. Arôme Vanille.
 Lippenbalsem. Bamboe Fibre/ ABS. SPF15. Vanille Aroma.

📏 Ø 1.9 × 7 cm 📦 500 / 25 🏷️ Print Code: C(4)

aroma vanilla



Bowok 1630

Lip Balm. Bamboo. SPF15. Vanilla Aroma.
 Lippenbalsam. Bambus. SPF15. Vanille Aroma.
 Baume Lèvres. Bambou. SPF15. Arôme Vanille.
 Lippenbalsem. Bamboe. SPF15. Vanille Aroma.

📏 Ø 4.4 cm 📦 400 / 50 🏷️ Print Code: C(1), L1



Fitol 1631

Lip Balm. Bamboo. SPF15. Vanilla Aroma.
 Lippenbalsam. Bambus. SPF15. Vanille Aroma.
 Baume Lèvres. Bambou. SPF15. Arôme Vanille.
 Lippenbalsem. Bamboe. SPF15. Vanille Aroma.

📏 Ø 2 × 7.6 cm 📦 500 / 50 🏷️ Print Code: C(4), L1



Epson 5942

Lip Balm. SPF15. Vanilla Aroma.
 Lippenbalsam. SPF15. Vanille Aroma.
 Baume Lèvres. SPF15. Arôme Vanille.
 Lippenbalsem. SPF15. Vanille Aroma.

Ø 3.8 cm 500 / 50 Print Code: C(1)



Bortum 20139

Lip Balm. SPF15. Vanilla Aroma.
 Lippenbalsam. SPF15. Vanille Aroma.
 Baume Lèvres. SPF15. Arôme Vanille.
 Lippenbalsem. SPF15. Vanille Aroma.

Ø 3.7 x 1.8 cm 500 / 50 Print Code: C(1), W



Mushu 20569

Lip Balm. SPF15. Vanilla Aroma.
 Lippenbalsam. SPF15. Vanille Aroma.
 Baume Lèvres. SPF15. Arôme Vanille.
 Lippenbalsem. SPF15. Vanille Aroma.

5 x 1.5 x 5 cm 500 / 50 Print Code: C(1), W



Zendal 6784

Lip Balm. SPF15. Vanilla Aroma. Mirror Included.
 Lippenbalsam. SPF15. Vanille Aroma. Spiegel Inklusief.
 Baume Lèvres. SPF15. Arôme Vanille. Miroir Inclusif.
 Lippenbalsem. SPF15. Vanille Aroma. Spiegel Inclusief.

Ø 4.8 x 1.6 cm 500 / 100 Print Code: C(1), W



22

aroma
vanilla



New

Yohan 20568

Set. PP. Sunscreen Lotion SPF30. After Sun. Hydroalcoholic Gel. Citronella Spray and Soothing for Bites.
 Set. PP. Sonnenschutzmittel SPF30. After Sun. Hydroalkoholisches Gel. Zitronellenspray und Beruhigungsmittel für Stiche.
 Set. PP. Crème Solaire SPF30. After Sun. Gel Hydroalcoolique. Spray à la Citronnelle et Apaisant pour les Piqûres.
 Set. PP. Zonnebrandcrème SPF30. After Sun. Hydroalcoholische Gel. Citronellaspray en Verzachtend bij Beten.

11 x 13.5 x 2 cm 80 / 40 Print Code: D(1), W

SUNSCREEN



19



19



New

03

LIP BALM

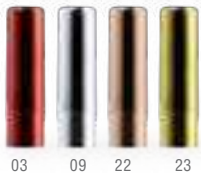

03 09 22 23



01 03 04 05 11 02 07 21 16



01 04 05 07 11 19

Tarian 6324

Lip Balm. SPF15. Vanilla Aroma.
 Lippenbalsam. SPF15. Vanille Aroma.
 Baume Lèvres. SPF15. Arôme Vanille.
 Lippenbalsem. SPF15. Vanille Aroma.

1.9 x 7 cm 500 / 25 Print Code: C(1)

Nirox 5053

Lip Balm. SPF15. Vanilla Aroma.
 Lippenbalsam. SPF15. Vanille Aroma.
 Baume Lèvres. SPF15. Arôme Vanille.
 Lippenbalsem. SPF15. Vanille Aroma.

1.9 x 7 cm 500 / 25 Print Code: C(4)

Canen 20567

Set. Sunscreen Lotion SPF30. Lip Balm SPF15. Vanilla Aroma.
 Set. Sonnenschutzmittel SPF30. Lippenbalsam SPF15. Vanille Aroma.
 Set. Crème Solaire SPF30. Baume Lèvres SPF15. Arôme Vanille.
 Set. Zonnebrandcrème SPF30. Lippenbalsem SPF15. Vanille Aroma.

2 x 9 cm 500 / 50 Print Code: C(4)



11

03



04



05



01



19

Kison 4970

Heat Pack. Reusable.
Taschenwärmer. Wiederverwendbar.
Patch Chaleur. Réutilisable.
Warmte Pakket. Herbruikbaar.

📏 Ø 10 x 1 cm 📦 150 / 50 🖨️ Print Code: F(1)



Zaroa 6783

Heat Pack. Reusable.
Taschenwärmer. Wiederverwendbar.
Patch Chaleur. Réutilisable.
Warmte Pakket. Herbruikbaar.

📏 8 x 10 x 1 cm 📦 150 / 50 🖨️ Print Code: F(1)



19



05



04



11



03



01

Pikur 4971

Hot-Cold Pack. Cold and Warm. Reusable.
Wärme-Kälte Pflaster. Kalt und Warm. Wiederverwendbar.
Patch Chaud-Froid. Chaud et Froid. Réutilisable.
Thermisch Pakket. Koud en Warm. Herbruikbaar.

📏 6.5 x 13.5 x 1.5 cm 📦 150 / 50 🖨️ Print Code: Consulter



Keinar 20552

Hot-Cold Pack. Cold and Warm. Reusable.
 Wärme-Kälte Pflaster. Kalt und Warm. Wiederverwendbar.
 Patch Chaud-Froid. Chaud et Froid. Réutilisable.
 Thermisch Pakket. Koud en Warm. Herbruikbaar.

20 x 12,5 x 1,5 cm 50 / 25 Print Code: N(8)



Franium 20553

Hot-Cold Pack. Cold and Warm. Reusable.
 Wärme-Kälte Pflaster. Kalt und Warm. Wiederverwendbar.
 Patch Chaud-Froid. Chaud et Froid. Réutilisable.
 Thermisch Pakket. Koud en Warm. Herbruikbaar.

Ø 12,5 x 1,5 cm 100 / 50 Print Code: N(8)



02

Milora 5170

Cool Eye Mask. Nylon.
 Kühl Augenmaske. Nylon.
 Masque Froid. Nylon.
 Verkoelend Oogmasker. Nylon.

21,5 x 6 cm 200 / 10 Print Code: N(8)



11



03



19



Suomen 20551

Cool Eye Mask. Cold and Warm. Reusable.
 Kühl Augenmaske. Kalt und Warm. Wiederverwendbar.
 Masque Chaud et Froid. Chaud et Froid. Réutilisable.
 Verkoelend Oogmasker. Koud en Warm. Herbruikbaar.

27,5 x 9,5 x 1 cm 50 / 25 Print Code: E(1)



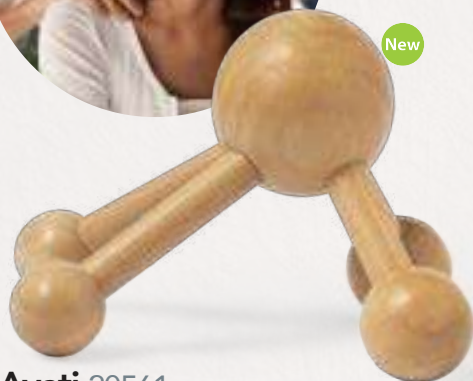
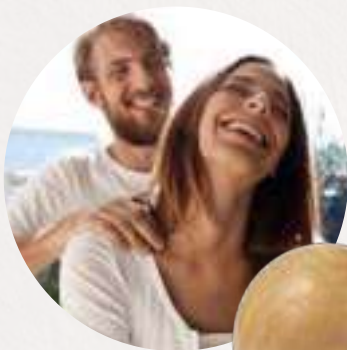

New

Avati 20561

Massager: Wood.
 Massagegerät: Holz.
 Masseur: Bois.
 Massage-Vorm: Hout.

12 x 9 x 10 cm 100 / 50
 Print Code: D(1), L1



New

Echem 20562

Massager: Wood.
 Massagegerät: Holz.
 Masseur: Bois.
 Massage-Vorm: Hout.

8.5 x 15 x 1.5 cm 200 / 100
 Print Code: C(4), L1



Wendy 1650

Massager: Bamboo.
 Massagegerät: Bambus.
 Masseur: Bambou.
 Massage-Vorm: Bamboe.

11.3 x 8.6 x 1.4 cm 150 / 50
 Print Code: C(4), L1



Goonix 1649

Massager: Metal/ Bamboo.
 Massagegerät: Metal/ Bambus.
 Masseur: Métal/ Bambou.
 Massage-Vorm: Metaal/ Bamboe.

11 x 23 x 11 cm 50
 Print Code: D(1), L1



Tefen 1748

Massager: Wood. 4 Accessories. Non-Woven Pouch.
 Massagegerät: Holz. 4 Teile. Non-Woven Etui.
 Masseur: Bois. 4 Accessoires. Étui T.N.T..
 Massage-Vorm: Hout. 4 Accessoires. Non-Woven Zakje.

25 x 10 x 14 cm 20
 Print Code: G(1)

massager

New



Wally 20179

Massager. 2 Modes. Battery 800 mAh. Polyester RPET Pouch.
 Massagegerät. 2 Positionen. Batterie 800 mAh. Polyester RPET Etui.
 Masseur. 2 Modes. Batterie 800 mAh. Étui Polyester RPET.
 Massage-Vorm. 2 Posities. Batterij 800 mAh. Polyester RPET Zakje.

11.3 x 10.2 x 5 cm 50 Print Code: E(1), F(1), N(8)



Owura 20452

Massager. 4 Accessories. 6 Modes. Battery 1200 mAh.
 Massagegerät. 4 Teile. 6 Positionen. Batterie 1200 mAh.
 Masseur. 4 Accessoires. 6 Modes. Batterie 1200 mAh.
 Massage-Vorm. 4 Accessoires. 6 Posities. Batterij 1200 mAh.

21 x 18.5 x 5.5 cm 10 Print Code: I(1)



New

Latval 20564

Massager. Led Lights. 3 Piles AAA Non Included.
 Massagegerät. Led Lichter. 3 AAA Batterien Nicht im Lieferumfang.
 Masseur. Lumières Led. 3 Piles AAA Non Incluses.
 Massage-Vorm. Led Lichten. 3 Batterijen AAA Niet Inklusief.

10.2 x 9.5 x 9.5 cm 50 Print Code: E(1)



New

Wuklu 20563

Massager.
 Massagegerät.
 Masseur.
 Massage-Vorm.

10.5 x 7 x 8.5 cm 50 Print Code: E(1)





Kalins 20545

Electric Toothbrush. 1 Batterie AA Not Included.
Elektrischer Zahnbürste. 1 AA Batterie Nicht im Lieferumfang.
Brosse à Dents Électrique. 1 Pile AA Non Inclusive.
Elektrische Tandborstel. 1 Batterij AA Niet Inclusief.

Ø 2.5 x 22 cm 200 / 50
Print Code: C(4)

New



Hyron 3825

Toothbrush. Foldable.
Zahnbürste. Faltbar.
Brosse à Dents. Pliable.
Tandenborstel. Opvouwbaar.

1.5 x 17.5 x 2.3 cm 500 / 50
Print Code: C(1), W

04



Siapax 5275

Sand Timer. 2 Minutes.
Sanduhr. 2 Minuten.
Sablier. 2 Minutes.
Zandloper. 2 Minuten.

1.8 x 6 x 2.5 cm 1000 / 100 Print Code: C(4)



01 04 05 19

Becu 20392

Toothbrush. Bamboo.
Zahnbürste. Bambus.
Brosse à Dents. Bambou.
Tandenborstel. Bamboe.

1.3 x 14.5 x 1.7 cm 500 / 50
Print Code: C(4), L1

New



03

New



Lowchen 20391

Set. Toothbrush Bamboo. Sand Timer Wheat Straw/ ABS, 2 Minutes. Cotton Pouch.
Set. Zahnbürste Bambus. Sanduhr Weizenstroh/ ABS, 2 Minuten. Baumwolle Etui.
Set. Brosse à Dents Bambou. Sablier Paille de Blé/ ABS, 2 Minutes. Étui Coton.
Set. Tandenborstel Bamboe. Zandloper Tarwestro/ ABS, 2 Minuten. Katoen Zakje.

20 x 7.5 x 1.7 cm 200 / 50 Print Code: C(4), F(1), L1, N(8)



19



04



05



03

Fident 5032

Set. Toothbrush and Sand Timer. 2 Minutes.
Set. Zahnbürste und Sanduhr. 2 Minuten.
Set. Brosse à Dents et Sablier. 2 Minutes.
Set. Tandenborstel en Zandloper. 2 Minuten.

8 x 20 x 2 cm 200 / 10 Print Code: F(1), L1

NATURAL CORK

Piglet 1640

Toothbrush. Bamboo/ Cork.
Zahnbürste. Bambus/ Kork.
Brosse à Dents. Bambou/ Liège.
Tandenborstel. Bamboe/ Kurk.



 1.2 x 20.3 x 1.6 cm  500 / 50
 Print Code: C(4), L1



Bamboo

Korol 6601



Toothbrush. Bamboo.
Zahnbürste. Bambus.
Brosse à Dents. Bambou.
Tandenborstel. Bamboe.

 Ø 3.9 x 20.3 cm  200 / 50
 Print Code: C(4), L1



Lencix 6362

Toothbrush. Bamboo.
Zahnbürste. Bambus.
Brosse à Dents. Bambou.
Tandenborstel. Bamboe.

 1.3 x 17.5 x 1.6 cm  500 / 50
 Print Code: C(4), L1



Bamboo



 WHEAT STRAW

Cleidol 6278

Toothbrush. Wheat Straw/ PP.
Zahnbürste. Weizenstroh/ PP.
Brosse à Dents. Paille de Blé/ PP.
Tandenborstel. Tarwestro/ PP.



 1.2 x 18 x 1.6 cm  500 / 50
 Print Code: C(4)



 WHEAT STRAW

Duncan 1639

Toothbrush. Wheat Straw/ PP. Foldable.
Zahnbürste. Weizenstroh/ PP. Faltpaar.
Brosse à Dents. Paille de Blé/ PP. Pliable.
Tandenborstel. Tarwestro/ PP. Opvouwbaar.

 1.6 x 16.2 x 2.3 cm  500 / 50
 Print Code: C(4), W



New

 WHEAT STRAW

Amondo 20546

Set. Foldable. Toothbrush Wheat Straw/ PP. Toothpaste 6 gr.
Set. Faltpaar. Zahnbürste Weizenstroh/ PP. Zahnpasta 6 gr.
Set. Pliable. Brosse à Dents Paille de Blé/ PP. Dentifrice 6 gr.
Set. Opvouwbaar. Tandenborstel Tarwestro/ PP. Tandpasta 6 gr.

 2 x 20 x 2 cm  300 / 100
 Print Code: C(4)



WOMAN

EAU DE
TOILETTE

MAN



20 ml

Steclers 2718

Eau de Toilette for Women. 20 ml. Refillable.
Eau de Toilette für Frauen. 20 ml. Wiederaufladbar.
Eau de Toilette pour Femme. 20 ml. Rechargeable.
Eau de Toilette voor Vrouwen. 20 ml. Navulbaar.

📏 Ø 2.5 x 10.5 cm 📦 100 🖨️ Print Code: E(1)



20 ml

Dauson 2717

Eau de Toilette for Men. 20 ml. Refillable.
Eau de Toilette für Männer. 20 ml. Wiederaufladbar.
Eau de Toilette pour Homme. 20 ml. Rechargeable.
Eau de Toilette voor Mannen. 20 ml. Navulbaar.

📏 Ø 2.5 x 10.5 cm 📦 100 🖨️ Print Code: E(1)

**Essential Kit 1643**

Set. Comb Wheat Straw/ PP. Toothbrush Wheat Straw/ PP. Toothpaste 6 gr. Bar Soap 20 gr.
Set. Kamm Weizenstroh/ PP. Zahnbürste Weizenstroh/ PP. Zahnpasta 6 gr. Seifenstück 20 gr.
Set. Peigne Paille de Blé/ PP. Brosse à Dents Paille de Blé/ PP. Dentifrice 6 gr. Savon 20 gr.
Set. Kam Tarwestro/ PP. Tandeborstel Tarwestro/ PP. Tandpasta 6 gr. Stuk Zeep 20 gr.

📏 14.5 x 2.5 x 4.7 cm 📦 200/50 🖨️ Print Code: C(1), B(4)

**Shaving Kit 1642**

Set. Razor Blade Wheat Straw/ PP. Shaving Gel 8 gr.
Set. Rasierklinge Weizenstroh/ PP. Rasiergel 8 gr.
Set. Lame de rasoir Paille de Blé/ PP. Gel de rasage 8 gr.
Set. Scheermes Tarwestro/ PP. Scheerigel 8 gr.

📏 10.5 x 2.5 x 4.5 cm 📦 300/50 🖨️ Print Code: C(1), B(4)

**Dental Kit 1641**

Set. Toothbrush Wheat Straw/ PP. Toothpaste 6 gr.
Set. Zahnbürste Weizenstroh/ PP. Zahnpasta 6 gr.
Set. Brosse à Dents Paille de Blé/ PP. Dentifrice 6 gr.
Set. Tandeborstel Tarwestro/ PP. Tandpasta 6 gr.

📏 14 x 1.5 x 2.5 cm 📦 300/50 🖨️ Print Code: C(1), B(4)



Dorio 20541

Emergency Kit, PP, 7 Accessories.
 Erste Hilfe Set, PP, 7 Teile.
 Kit Urgence, PP, 7 Accessoires.
 Ehbo-Set, PP, 7 Accessoires.

5 x 9.5 x 2.5 cm 100
 Print Code: D(1)



Festival 20542

Kit, PP, 10 Accessories.
 Kit, PP, 10 Teile.
 Kit, PP, 10 Accessoires.
 Kit, PP, 10 Accessoires.

5 x 9.5 x 2.5 cm 100
 Print Code: D(1)



19

Redcross 9496

Emergency Kit, Polyester 600D, 17 Accessories.
 Erste Hilfe Set, Polyester 600D, 17 Teile.
 Kit Urgence, Polyester 600D, 17 Accessoires.
 Ehbo-Set, Polyester 600D, 17 Accessoires.

18 x 12 x 6 cm 100 / 20 Print Code: E(1)



03



New

Neiru 20540

Emergency Kit, PP, 22 Accessories.
 Erste Hilfe Set, PP, 22 Teile.
 Kit Urgence, PP, 22 Accessoires.
 Ehbo-Set, PP, 22 Accessoires.

10 x 13.5 x 3 cm 100
 Print Code: E(1)





Brenda 1648

Eye Mask. Satin. Satin Pouch.
Augenmaske. Satin. Satin Etui.
Masque. Satiné. Étui Satiné.
Slaapmasker. Satijn. Satijn Zakje.

20 x 10 cm 500 / 50 Print Code: D(1), N(8)



06



02

08

Bezz 20352

Travel Eye Mask. Polyester.
Reise Augenmaske. Polyester.
Masque Voyage. Polyester.
Slaapmasker. Polyester.

23.5 x 8.5 cm 400 / 100 Print Code: D(1), N(8)



02



08

Asleep 9800

Travel Eye Mask. Microfibre.
Reise Augenmaske. Mikrofaser.
Masque Voyage. Microfibre.
Slaapmasker. Microfibre.

18.5 x 9 cm 1000 / 100 Print Code: D(1), N(8)



02

New



01



03



19



11



05



Vitok 20566

Set. PP. Ear Plugs and 5 Adhesive Nasal Strips.
Set. PP. Ohrstöpsel und 5 Nasenplaster.
Set. PP. Bouchons d'oreilles et 5 Bandes Nasales Adhésives.
Set. PP. Oordopjes en 5 Plakneusstrips.

10.5 x 2.5 x 4.5 cm 200 / 50 Print Code: C(1), V



03



04

05

11

19

Panoss 4677

Earplugs. EVA.
Ohrstöpsel. EVA.
Bouchons Antibruit. EVA.
Oordopjes. EVA.

Ø 2.2 x 6.4 cm 1000 / 200 Print Code: C(1)



Rinoco 1237

Mirror. Bamboo. 1 Magnifying Mirror 3X.
Taschenspiegel. Bambus. 1 Vergrößerung 3X.
Miroir. Bambou. 1 Augmentation 3X.
Zakspegel. Bamboe. 1 Vergroting 3X.

20 x 18 x 4.5 cm 20 Print Code: E(1), L1



Berry 1210

Weighing Scales. Bamboo. 2 Batteries AAA Not Included.
Waage. Bambus. 2 AAA Batterien Nicht im Lieferumfang.
Balance. Bambou. 2 Piles AAA Non Incluses.
Weegschaal. Bamboe. 2 Batterijen AAA Niet Inclusief.

30 x 3 x 30 cm 10 Print Code: E(1), L2



BATTERY LEVEL
INDICATOR



Dreijar 1633

Nail File. Bamboo.
Nagelpfeile. Bambus.
Lime. Bambou.
Nagelvijl. Bamboe.

4 x 10.5 x 0.4 cm 1000 / 100 Print Code: C(4), L1



Cierny 20544

Exfoliating Massage Brush. Wood.
Massage Peeling Bürste. Holz.
Brosse de Massage Exfoliante. Bois.
Exfoliërende Massageborstel. Hout.

5 x 20 x 2.7 cm 100 / 50 Print Code: D(1), L1



Atriax 20353

Sewing Kit. Bamboo. Mirror Included.
Nähset Kit. Bambus. Spiegel Inklusiv.
Set Coûture. Bambou. Miroir Inclusif.
Naaiset. Bamboe. Spiegel Inclusief.

Ø 7.4 x 2 cm 200 / 50 Print Code: E(4), L2, W

Take Care

PERSONAL CARE & WELLNESS

New



WHEAT
STRAW

Nocote 20560

Emulsifier: Wheat Straw/ PP/ Silicone.
Emulgator: Weizenstroh/ PP/ Silikon.
Émulsionneur: Paille de Blé/ PP/ Silicone.
Emulgator: Tarwestro/ PP/ Siliconen.

📏 8 x 7 cm 📦 100/50 🖨️ Print Code: D(1)



Ruck 1635

Exfoliating Massage Brush. Wood. Cotton Pouch.
Massage Peeling Bürste. Holz. Baumwolle Etui.
Brosse de Massage Exfoliante. Bois. Étui Coton.
Exfoliërende Massageborstel. Hout. Katoen Zakje.

📏 11 x 3.5 cm 📦 50 🖨️ Print Code: F(6), L1, N(8), O



Rustuff 4513

20 x 20 cm

Absorbent Towel. Microfibre 310 g/ m².
Saugfähiges Handtuch. Mikrofaser 310 g/ m².
Serviette Absorbante. Microfibre 310 g/ m².
Absorberende Handdoek. Microfibre 310 g/ m².

📏 6 x 8 x 6 cm 📦 200/50 🖨️ Print Code: D(1)



New

Seido 20543

Bathroom Set. 4 Accessories. Cotton Pouch.
Badezimmer-Set. 4 Teile. Baumwolle Etui.
Set de Bains. 4 Accessoires. Étui Coton.
Badkamerset. 4 Accessoires. Katoen Zakje.

📏 15 x 20 x 5 cm 📦 50 🖨️ Print Code: D(1), F(6), L1, N(8), O

Kika 1634

Sponge Bath. PE Fibre.
Schwammbad. PE Faser.
Éponge de Bain. Fibre de PE.
Sponsbad. PE Fibre.

📏 10 cm 📦 500/50 🖨️ Print Code: D(1)





100%
vegan

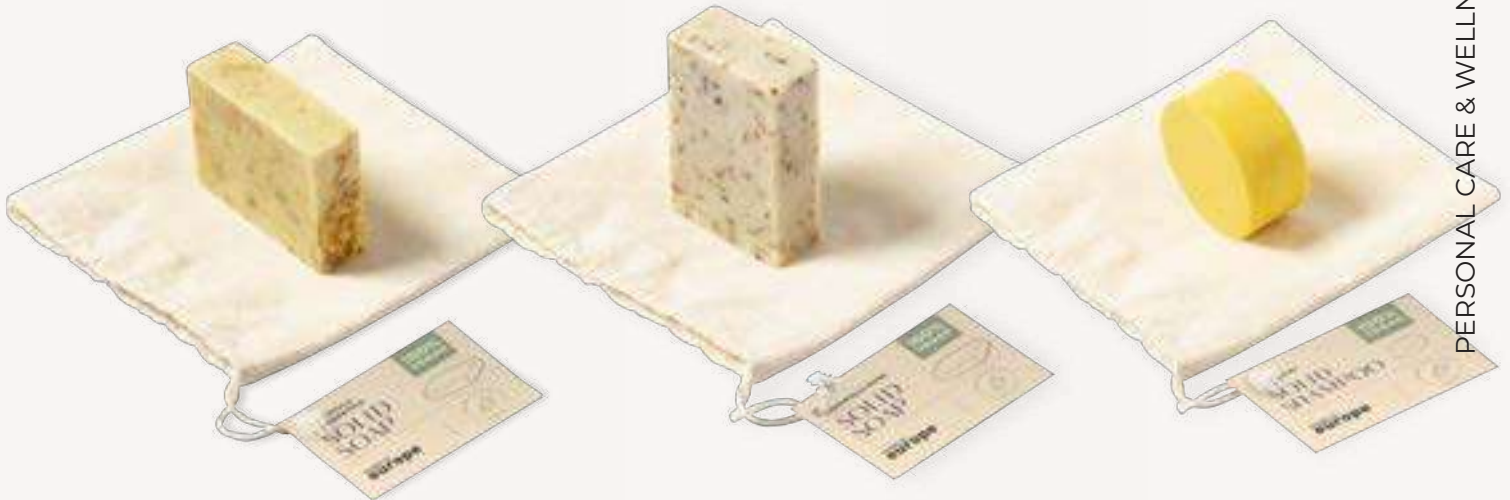

Gopax 2724

Soap. Calendula and Chamomile. 100 gr.
Seife. Ringelblume und Kamille. 100 gr.
Savon. Calendula et Camomille. 100 gr.
Zeep. Calendula en Kamille. 100 gr.

15 x 15 cm 30 Print Code: F(6), N(8), O

Zolya 2725

Soap. Centifolia Rose. 100 gr.
Seife. Centifolia Rose. 100 gr.
Savon. Rose Centifolia. 100 gr.
Zeep. Centifolia Roos. 100 gr.

15 x 15 cm 30 Print Code: F(6), N(8), O

Nanon 2726

Shampoo. Shikakai. 80 gr.
Shampoo. Shikakai. 80 gr.
Shampooing. Shikakai. 80 gr.
Shampoo. Shikakai. 80 gr.

15 x 15 cm 25 Print Code: F(6), N(8), O



Turuen 2728

Shampoo Set. 3 Pieces 30 gr. Shikakai, Amalaki and Ghassoul.
Shampoo Set. 3 Stück 30 gr. Shikakai, Amalaki und Ghassoul.
Set Shampooing. 3 Pièces 30 gr. Shikakai, Amalaki et Ghassoul.
Shampoo Set. 3 Stuks 30 gr. Shikakai, Amalaki en Ghassoule.

15 x 15 cm 25 Print Code: F(6), N(8), O



Mionca 2727

Set. Mud of Dead Sea Exfoliating Soap 50 gr. And Shikakai Shampoo 30 gr.
Set. Schlamm vom Toten Meer Peelingseife 50 gr. Und Shikakai Shampoo 30 gr.
Set. Savon Exfoliant de la Mer Morte 50 gr. Et Shampooing Shikakai 30 gr.
Set. Zee Exfoliërende Dode Modderzeep 50 gr. En Shikakai Shampoo 30 gr.

15 x 15 cm 25 Print Code: F(6), N(8), O



Tospin 1397

Face Cleansing Brush, Wood.
Gesichtsreinigungsbürste, Holz.
Brosse Nettoyante du Visage, Bois.
Gezichtsreinigingsborstel, Hout.

8.3 x 4.5 x 5.3 cm 100 / 50
Print Code: C(4), L1



Kiam 1239

Cosmetic Pad Dispenser, Bamboo. 10 Cotton Wipes, Reusable, Cotton Washing Bag Included.
Spender für Make-up-Entferner-Tücher, Bambus. 10 Baumwolltücher, Wiederverwendbar, Baumwolle Waschesack Inklusiv.
Distributeur de Lingettes Démaquillantes, Bambou. 10 Lingettes Coton, Réutilisables, Sac de Lavage Coton Inclusif.
Make-up Remover Wattenhouder, Bamboe. 10 Katoen Poetsdoekjes, Herbruikbaar, Katoen Waszak Inclusief.

Ø 10 x 9.7 cm 50 Print Code: D(4), L1



New

15 ml



Diyozza 20911

Vaporizer, Led Lights, 15 ml, Batterie 250 mAh.
Zerstäuber, Led Lichten, 15 ml, Batterie 250 mAh.
Vaporisateur, Lumières Led, 15 ml, Batterie 250 mAh.
Sproeier, Led Lichten, 15 ml, Batterij 250 mAh.

3 x 10 x 3 cm 200 / 50 Print Code: D(4)



02



01

Madax 20554

Headband, Polyester.
Haarband, Polyester.
Bandeau, Polyester.
Haarband, Polyester.

69 x 8.5 cm 500 / 100
Print Code: F(1), N(8)



FACE CARE

759

PERSONAL CARE & WELLNESS



Charmand 1398

Face Massager: Wood.
Gesichtsmassagegerät. Holz.
Masseur Facial. Bois.
Gezichts Massager. Hout.

5.7 x 12.8 x 2 cm 500 / 50 Print Code: C(4), L1



Zynka 20558

Face Massager: Pink Jade Stone.
Gesichtsmassagegerät. Rosa Jade Stein.
Masseur Facial. Pierre de Jade Rose.
Gezichts Massager. Roze Jade Steen.

6 x 14 x 4 cm 100 / 50 Print Code: C(1)



Lisey 20913

Face Massager: 2 Modes. Button Battery Included.
Gesichtsmassagegerät. 2 Positionen. Knopfzelle inklusive.
Masseur Facial. 2 Modes. Pile Bouton Incluse.
Gezichts Massager. 2 Posities. Knooppcel Batterij Inclusief.

3.5 x 15.1 x 4 cm 200 / 50 Print Code: D(1), L1



Cotton & WHEAT STRAW



Kurt 1632

Eyeshadow Applicator Set, Wheat Straw/ PP, 6 Accessories, Cotton Pouch.
Set Make-up Pinset, Weizenstroh/ PP, 6 Teile, Baumwolle Etui.
Set Broches Maquillage, Paille de Blé/ PP, 6 Accessoires, Étui Coton.
Oogschaduw Kwasten Set, Tarwestro/ PP, 6 Accessoires, Katoen Zakje.

10 x 16.5 x 1 cm 200 / 20 Print Code: F(1), B(4), N(8)



New

Iringu 20565

Facial Mask Set, Bamboo, 4 Pieces.,
Gesichtsmasken-Set, Bambus, 4 Stück.
Set Masques Faciaux, Bamboo, 4 Pièces.
Gezichtsmasker Set, Bamboe, 4 Stuks.

16.5 x 15 x 6.5 cm 20 Print Code: D(1), L1



BAMBOO



Yernia 6984

Manicure Set. Canvas. 6 Accessories.
 Maniküre Set. Canvas. 6 Teile.
 Set Manicure. Toile. 6 Accessoires.
 Manicure Set. Canvas. 6 Accessoires.

6 x 11 x 2 cm 200 / 50 Print Code: E(1), N(8)



Treisy 6983

Manicure Set. Cork. 6 Accessories.
 Maniküre Set. Kork. 6 Teile.
 Set Manicure. Liège. 6 Accessoires.
 Manicure Set. Kurk. 6 Accessoires.

6 x 11 x 2 cm 200 / 50 Print Code: E(1), L1, N(8)

**NATURAL
CORK**



Cotton

Kilian 1477

Manicure Set. Cotton. 2 Accessories.
 Maniküre Set. Baumwolle. 2 Teile.
 Set Manicure. Coton. 2 Accessoires.
 Manicure Set. Katoen. 2 Accessoires.

6.1 x 12.5 x 1.5 cm 400 / 200
 Print Code: F(1), L1, N(8)



Lucky 1638

Manicure Set. Felt RPET. 6 Accessories.
 Maniküre Set. Filz RPET. 6 Teile.
 Set Manicure. Feutrine RPET. 6 Accessoires.
 Manicure Set. Vilt RPET. 6 Accessoires.

6 x 11 x 2 cm 200 / 50 Print Code: E(1), N(8)





Plumiax 5907

Pocket Mirror. PU. 1 Magnifying Mirror 2X.
Taschenspiegel. PU. 1 Vergrößerung 2X.
Miroir. Similicuir. 1 Augmentation 2X.
Zakspiegel. PU. 1 Vergroting 2X.

📏 Ø 6.5 x 0.9 cm 📦 300 / 50 🖨️ Print Code: C(4), L1, W



Busey 1637

22

Pocket Mirror. 1 Magnifying Mirror 2X.
Taschenspiegel. 1 Vergrößerung 2X.
Miroir. 1 Augmentation 2X.
Zakspiegel. 1 Vergroting 2X.

📏 Ø 6.4 x 1.5 cm 📦 300 / 50 🖨️ Print Code: C(1)



23



09



New

19



01



02



03

Angie 20244

Holder. Foldable. Mirror Included.
Halter. Faltbar. Spiegel Inklusiv.
Support. Pliable. Mirror Inclusive.
Houder. Opvouwbaar. Spiegel Inclusief.

📏 7.2 x 7.5 x 10 cm 📦 300 / 100
🖨️ Print Code: C(4)



03



19

01

07

Thiny 3052

Pocket Mirror.
Taschenspiegel.
Miroir.
Zakspiegel.

📏 Ø 6 x 0.5 cm 📦 500 / 50 🖨️ Print Code: C(4), W



1X

2X

Naza 3192

Pocket Mirror. 1 Magnifying Mirror 2X.
Taschenspiegel. 1 Vergrößerung 2X.
Miroir. 1 Augmentation 2X.
Zakspiegel. 1 Vergroting 2X.

📏 Ø 6.7 x 1.3 cm 📦 400 / 50 🖨️ Print Code: C(4)



19

07

01

03



Arendel 1236

Pocket Mirror. Bamboo.
Taschenspiegel. Bambus.
Miroir. Bambou.
Zakspiegel. Bamboe.

Ø 6.9 x 0.8 cm 200 / 50 Print Code: C(4), L1, W



Gradiox 6554

Pocket Mirror. Wheat Straw/ ABS.
Taschenspiegel. Weizenstroh/ ABS.
Miroir. Paille de Blé/ ABS.
Zakspiegel. Tarvestro/ ABS.

Ø 7 x 0.5 cm 500 / 50 Print Code: C(4), W



Susil 1718

Pocket Mirror. Bamboo.
Taschenspiegel. Bambus.
Miroir. Bambou.
Zakspiegel. Bamboe.

Ø 7.5 x 1.5 cm 200 / 50 Print Code: C(4), L1, W

New



Segenen 20555

Pocket Mirror. Cork.
Taschenspiegel. Kork.
Miroir. Liège.
Zakspiegel. Kurk.

Ø 7 x 0.8 cm 200 / 50 Print Code: C(4), L1, W



Alunax 6793

Pocket Mirror. Cork, 1 Magnifying Mirror 2X.
Taschenspiegel. Kork, 1 Vergrößerung 2X.
Miroir. Liège, 1 Augmentation 2X.
Zakspiegel. Kurk, 1 Vergroting 2X.

Ø 6.2 x 2 cm 200 / 50 Print Code: C(4), L1, W

MAXSA

New



Tambour 20557

Pocket Mirror. Cork, Foldable.
Taschenspiegel. Kork, Fallbar.
Miroir. Liège, Pliable.
Zakspiegel. Kurk, Opvouwbaar.

7 x 11 x 0.7 cm 200 / 50 Print Code: C(4), L1, W

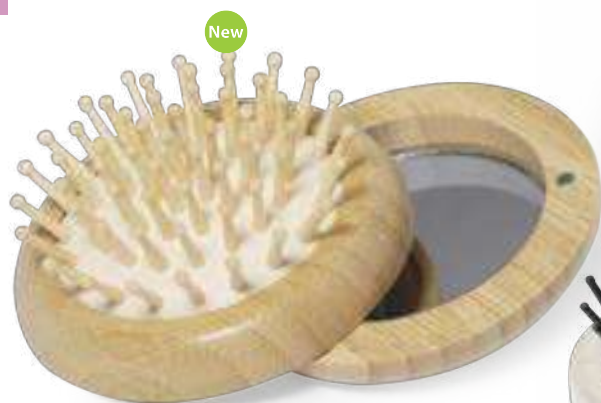
WHEAT
STRAW

New

Bonnie 20178

Hairbrush with Mirror. Bamboo.
Bürste mit Spiegel. Bambus.
Brosse avec Miroir. Bambou.
Haarborstel Met Spiegel. Bamboe.

📏 Ø 8.2 x 2.4 cm 📦 100 / 50 🏷️ Print Code: D(4), L2



New

Flege 20559

Hairbrush with Mirror. Wheat Straw/ ABS. Foldable.
Bürste mit Spiegel. Weizenstroh/ ABS. Faltbar.
Brosse avec Miroir. Paille de Blé/ ABS. Pliable.
Haarborstel Met Spiegel. Tarwestro/ ABS. Opvouwbaar.

📏 Ø 6.6 x 2.8 cm 📦 200 / 50 🏷️ Print Code: D(4)

**Glance 9884**

Hairbrush with Mirror. Foldable.
Bürste mit Spiegel. Faltbar.
Brosse avec Miroir. Pliable.
Haarborstel Met Spiegel. Opvouwbaar.

📏 Ø 6.6 x 2.8 cm 📦 200 / 50 🏷️ Print Code: D(4)



22

09

23

Tramux 6001

Hairbrush. Anti-Tangle.
Bürste. Anti-Entwirrung.
Brosse. Démêlante.
Haarborstel. Antiklit.

📏 6.7 x 9 x 4.5 cm 📦 200 / 50 🏷️ Print Code: D(1)

Zilam 5829

Hairbrush. Anti-Tangle.
Bürste. Anti-Entwirrung.
Brosse. Démêlante.
Haarborstel. Antiklit.

📏 6.7 x 9 x 4.5 cm 📦 200 / 50 🏷️ Print Code: D(1)



Dantel 6557

Hairbrush. Wheat Straw/ PP.
Bürste. Weizenstroh/ PP.
Brosse. Paille de Blé/ PP.
Haarborstel. Tarwestro/ PP.

5 x 17,3 x 3,4 cm 200 / 20
 Print Code: D(4)



Aveiro 1062

Hairbrush. Bamboo.
Bürste. Bambus.
Brosse. Bambou.
Haarborstel. Bamboe.

6,3 x 20 x 3,5 cm 100 / 10
 Print Code: D(1), L1



Dianex 1636

Set. Wood. 2 Pieces. Cotton Pouch.
Set. Holz. 2 Stück. Baumwolle Etui.
Set. Bois. 2 Pièces. Étui Coton.
Set. Hout. 2 Stuks. Katoen Zakje.

18 x 12 cm 100 / 50
 Print Code: D(1), F(1), L1, N(8)



Wofel 6503

Comb. Wheat Straw/ PP.
Kamm. Weizenstroh/ PP.
Peigne. Paille de Blé/ PP.
Kam. Tarwestro/ PP.

2,8 x 17 x 0,3 cm 1000 / 50
 Print Code: C(4)



Bamboo

Garet 6504

Comb. Bamboo.
Kamm. Bambus.
Peigne. Bambou.
Kam. Bamboe.

3,1 x 18,7 x 0,5 cm 500 / 100
 Print Code: C(4), L1



New

Horpok 20556

Comb. Bamboo.
Kamm. Bambus.
Peigne. Bambou.
Kam. Bamboe.

13,5 x 3 x 0,6 cm 500 / 100
 Print Code: C(4), L1



Bamboo

New



Moly 20526

Jewellery Wrap. PU.
Schmuckbox. PU.
Etui Bijoux. Similicuir.
Sieradendoosje. PU.

8.5 x 4 x 4 cm 200 / 50 Print Code: C(1)



Fontana 1238

Jewellery Box. Bamboo, Mirror Included.
Schmuckbox. Bambus. Spiegel Inklusive.
Etui Bijoux. Bamboo. Miroir Inclusie.
Sieradendoosje. Bamboe. Spiegel Inclusief.

Ø 7.9 x 4.1 cm 100 / 50 Print Code: D(4), L1

New



Azix 20527

Jewellery Wrap. Cotton.
Schmuckbox. Baumwolle.
Etui Bijoux. Coton.
Sieradendoosje. Katoen.

30 x 18 cm 200 / 10 Print Code: E(1), N(8)



Gonzalex 1728

Jewellery Wrap. Bamboo.
Schmuckbox. Bambus.
Etui Bijoux. Bamboo.
Sieradendoosje. Bamboe.

8 x 2.5 x 7.6 cm 100 / 50 Print Code: C(4), L1, W



New

03

Velerox 21047

Beauty Bag. 100% Recycled Cotton.
Kosmetik Tasche. 100% Recycling Baumwolle.
Nécessaire. 100% Coton Recyclé.
Toiletas. 100% Gerecycled Katoen.

23 x 18 x 8 cm 250 / 50
Print Code: F(1), N(8), O, P



New

21

Belix 20529

Beauty Bag. 100% Recycled Cotton.
Kosmetik Tasche. 100% Recycling Baumwolle.
Nécessaire. 100% Coton Recyclé.
Toiletas. 100% Gerecycled Katoen.

22 x 17 x 6 cm 300 / 50
Print Code: F(1), N(8), O, P

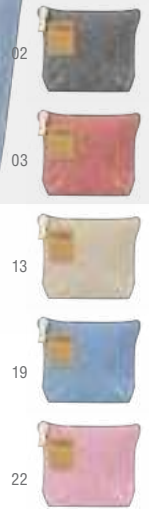

13

Plaum 1167

Beauty Bag. 100% Recycled Cotton.
Kosmetik Tasche. 100% Recycling Baumwolle.
Nécessaire. 100% Coton Recyclé.
Toiletas. 100% Gerecycled Katoen.

22 x 16 x 6 cm 200 / 10
Print Code: F(1), N(8), O



03

Halgar 6832

Beauty Bag. 100% Recycled Cotton.
Kosmetik Tasche. 100% Recycling Baumwolle.
Nécessaire. 100% Coton Recyclé.
Toiletas. 100% Gerecycled Katoen.

21 x 12.5 cm 300 / 50
Print Code: F(1), N(8), O

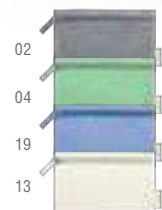



Plumok 1169



Beauty Bag. 100% Organic Cotton.
Kosmetik Tasche. 100% Organische Baumwolle.
Nécessaire. 100% Coton Organique.
Toilettas. 100% Organisch Katoen.

 21 x 12,5 cm  300 / 50  Print Code: F(1), N(8), O



Boyan 1168

Beauty Bag. 100% Organic Cotton.
Kosmetik Tasche. 100% Organische Baumwolle.
Nécessaire. 100% Coton Organique.
Toilettas. 100% Organisch Katoen.



 22 x 16 x 6 cm  200 / 10  Print Code: F(1), N(8), O



04

Rupert 1155

Beauty Bag. 100% Hemp Fabric.
Kosmetik Tasche. 100% Hanf-Stoff.
Nécessaire. 100% Tissu de Chanvre.
Toilettas. 100% Hennep Stof.



 20,5 x 14 x 8,5 cm  300 / 50  Print Code: F(1), N(8)

13



Ramsek 1645

Beauty Bag. Felt RPET.
Kosmetik Tasche. Filz RPET.
Nécessaire. Feutrine RPET.
Toilettas. Vilt RPET.

 22 x 14 x 6,5 cm  200 / 50  Print Code: F(1), N(8)



Radynel 21054

Beauty Bag, PU/ Cotton.
Kosmetik Tasche, PU/ Baumwolle.
Nécessaire, Simlicuir/ Coton.
Toiletas, PU/ Katoen.

24 x 15 x 5 cm 300 / 50
Print Code: F(1), N(8), O

09



22



New

23



Subrum 6619

Beauty Bag, Cork/ Cotton.
Kosmetik Tasche, Kork/ Baumwolle.
Nécessaire, Liège/ Coton.
Toiletas, Kurk/ Katoen.

21.5 x 16 x 5 cm 200 / 10
Print Code: F(1), N(8), O



Tays 6827

Beauty Bag, Laminated Jute/ Cotton.
Kosmetik Tasche, Laminiertes Jutestoff/ Baumwolle.
Nécessaire, Jute Laminé/ Coton.
Toiletas, Gelamineerd Jute/ Katoen.

21.5 x 16.5 x 5 cm 250 / 50
Print Code: F(1), N(8), O



Talso 6825

Beauty Bag, 100% Cotton.
Kosmetik Tasche, 100% Baumwolle.
Nécessaire, 100% Coton.
Toiletas, 100% Katoen.

Ø 15 x 25 cm 200 / 10
Print Code: F(6), N(8), O, P



02



07

13

Lendil 6120

Beauty Bag, 100% Cotton.
Kosmetik Tasche, 100% Baumwolle.
Nécessaire, 100% Coton.
Toiletas, 100% Katoen.

23 x 18 x 8 cm 300 / 50
Print Code: F(1), N(8), O



Adams Fairtrade 1268

Beauty Bag. 100% Cotton.
Kosmetik Tasche. 100% Baumwolle.
Nécessaire. 100% Coton.
Toiletta. 100% Katoen.

23 x 17 x 6 cm 300 / 50 Print Code: F(1), N(8), O



Grafox Fairtrade 1269

Beauty Bag. 100% Cotton.
Kosmetik Tasche. 100% Baumwolle.
Nécessaire. 100% Coton.
Toiletta. 100% Katoen.

20.5 x 14 x 7.5 cm 300 / 50 Print Code: F(1), N(8), O



New

Yink Fairtrade 20537

Beauty Bag. 100% Cotton.
Kosmetik Tasche. 100% Baumwolle.
Nécessaire. 100% Coton.
Toiletta. 100% Katoen.

23 x 17 x 6 cm 300 / 50 Print Code: F(1), N(8), O



New

Hinu Fairtrade 20536

Beauty Bag. 100% Cotton.
Kosmetik Tasche. 100% Baumwolle.
Nécessaire. 100% Coton.
Toiletta. 100% Katoen.

20.5 x 14 x 7.5 cm 300 / 50
Print Code: F(1), N(8), O



IDEA



The Fairtrade Cotton label guarantees that the product comes from a traceable and sustainable sourcing chain and helps us to identify garments where 100% of the composition is traceable Fairtrade cotton. All of the cotton is Fairtrade certified, traded, audited and sourced from Fairtrade producers. Visit www.info.fairtrade.net

El sello Fairtrade Cotton nos garantiza que el producto proviene de una cadena de aprovisionamiento de compra trazable y sostenible y nos ayuda a identificar las prendas en las que el 100% de su composición es algodón Fairtrade trazable. Todo el algodón es certificado Fairtrade, comercializado, auditado y proviene de productos Fairtrade. Visite www.infi.fairtrade.net

THE FUTURE
IS FAIR

New



Misir Fairtrade 20539

Beauty Bag. Laminated Jute/ Cotton.
Kosmetik Tasche. Laminiertes Jutestoff/ Baumwolle.
Nécessaire. Jute Laminé/ Coton.
Toiletas. Gelamineerd Jute/ Katoen.

23 x 15 x 8 cm 300 / 50 Print Code: F(1), N(8), O

PERSONAL CARE & WELLNESS

771

New



02

Adaldy Fairtrade 1754

Beauty Bag. 100% Cotton.
Kosmetik Tasche. 100% Baumwolle.
Nécessaire. 100% Coton.
Toiletas. 100% Katoen.

23 x 17 x 6 cm 300 / 50 Print Code: F(1), N(8), O



Chiril Fairtrade 20538

Beauty Bag. Laminated Jute/ Cotton.
Kosmetik Tasche. Laminiertes Jutestoff/ Baumwolle.
Nécessaire. Jute Laminé/ Coton.
Toiletas. Gelamineerd Jute/ Katoen.

21.5 x 16.5 x 5 cm 250 / 50 Print Code: F(1), N(8), O



13



RPET



New

Gean 20530

02

Beauty Bag. Polyester 600D RPET.
Kosmetik Tasche. Polyester 600D RPET.
Nécessaire. Polyester 600D RPET.
Toiletas. Polyester 600D RPET.

20 x 16 x 7 cm 50 Print Code: N(8)



08



New

08

Osoben 20534

Beauty Bag. Polyester 600D RPET.
Kosmetik Tasche. Polyester 600D RPET.
Nécessaire. Polyester 600D RPET.
Toiletas. Polyester 600D RPET.

22 x 14 x 6 cm 300 / 20
 Print Code: F(1), N(8), O



06



02



New

08

Harese 20535

Beauty Bag. Polyester 600D RPET.
Kosmetik Tasche. Polyester 600D RPET.
Nécessaire. Polyester 600D RPET.
Toiletas. Polyester 600D RPET.

21.5 x 14 x 10 cm 200 / 10
 Print Code: F(1), N(8), O



02



06



Akilax 6842

Beauty Bag. Polyester 600D RPET.
Kosmetik Tasche. Polyester 600D RPET.
Nécessaire. Polyester 600D RPET.
Toiletas. Polyester 600D RPET.

21 x 12 x 3 cm 500 / 50
Print Code: F(1), N(8)



Kopel 6423

Beauty Bag. Polyester 600D RPET.
Kosmetik Tasche. Polyester 600D RPET.
Nécessaire. Polyester 600D RPET.
Toiletas. Polyester 600D RPET.

21 x 13 x 8 cm 100 / 10
Print Code: F(1), N(8)



02



01



03



Saeki 5378

01

Beauty Bag, EVA.
Kosmetik Tasche, EVA.
Nécessaire, EVA.
Toiletas, EVA.

16.5 x 14 x 5 cm
Print Code: F(1)

300 / 25



11



05



19



01



19

11

07

03

05

Pelvar 6160

Beauty Bag, EVA.
Kosmetik Tasche, EVA.
Nécessaire, EVA.
Toiletas, EVA.

20.5 x 15 x 6 cm
200 / 50
Print Code: F(1)



Flumit 1646

Beauty Bag, Polyester/ EVA.
Kosmetik Tasche, Polyester/ EVA.
Nécessaire, Polyester/ EVA.
Toiletas, Polyester/ EVA.

20.5 x 15 x 6 cm
200 / 50
Print Code: F(1), N(8)



New



Tashi 20532

Beauty Bag. Laminated Jute/ PU.
Kosmetik Tasche. Laminiertes Jutestoff/ PU.
Nécessaire. Jute Laminé/ Similicuir.
Toiletas. Gelamineerd Jute/ PU.

29 x 17 cm 300 / 50
Print Code: F(1), L2



New



Kasmie 20531

Beauty Bag. Jute/ Cotton.
Kosmetik Tasche. Jutestoff/ Baumwolle.
Nécessaire. Jute/ Coton.
Toiletas. Jute/ Katoen.

22 x 17 x 5 cm 300 / 50
Print Code: F(1), N(8)

06



13

02

04

Natural Jute



Singla 5727

Beauty Bag. Laminated Jute.
Kosmetik Tasche. Laminiertes Jutestoff.
Nécessaire. Jute Laminé.
Toiletas. Gelamineerd Jute.

25 x 15 cm 300 / 10
Print Code: F(1), N(8)



Ringok 6828

Beauty Bag. Laminated Jute/ Cotton.
Kosmetik Tasche. Laminiertes Jutestoff/ Baumwolle.
Nécessaire. Jute Laminé/ Coton.
Toiletas. Gelamineerd Jute/ Katoen.

20 x 15 x 6 cm 250 / 50
Print Code: F(1), N(8)



Lindak 6626

Beauty Bag. Laminated Jute.
Kosmetik Tasche. Laminiertes Jutestoff.
Nécessaire. Jute Laminé.
Toiletas. Gelamineerd Jute.

25 x 16 x 6 cm 200 / 50
Print Code: F(1), N(8)



03

Kreston 6433



Sublimation Beauty Bag, Polyester.
Sublimations Kosmetik Tasche, Polyester.
Nécessaire Sublimation, Polyester.
Sublimatie Toilettas, Polyester.

22 x 14 x 6.5 cm 500 / 10
Print Code: F(1), N(8), R

Conakar 5729

Beauty Bag, Polyester.
Kosmetik Tasche, Polyester.
Nécessaire, Polyester.
Toilettas, Polyester.

22 x 14 x 6.5 cm 500 / 10
Print Code: F(1), N(8)



02



19



11



13

Chack 1170

Beauty Bag, Synthetic.
Kosmetik Tasche, Synthetisch.
Nécessaire, Synthétique.
Toilettas, Synthetisch.

21.5 x 16 x 6.5 cm 200 / 10
Print Code: E(1), L1



BIG SIZE

Theris 20528

Beauty Bag. 100% Recycled Cotton.
 Kosmetik Tasche. 100% Recycling Baumwolle.
 Nécessaire. 100% Coton Recyclé.
 Toilettas. 100% Gerecycled Katoen.



28 x 20 x 5 cm 300 / 50 Print Code: F(1), N(8), O, P



Babit 5879

Beauty Bag. Cotton/ Polyester. With Inner Lining.
 Kosmetik Tasche. Baumwolle/ Polyester. Mit Innenfutter.
 Nécessaire. Coton/ Polyester. Avec Doublure Intérieure.
 Toilettas. Katoen/ Polyester. Met Voering aan de Binnenzijde.

20 x 11 x 5.5 cm 200 / 10 Print Code: F(1), N(8)



13

Raberu 20533

Beauty Bag. Canvas.
 Kosmetik Tasche. Canvas.
 Nécessaire. Toile.
 Toilettas. Canvas.

25 x 12.5 x 10 cm 150 / 50 Print Code: F(1), N(8), O, P

06

**Iriam 5064**

19

Beauty Bag. PVC.
Kosmetik Tasche. PVC.
Nécessaire. PVC.
Toiletas. PVC.

17 x 12.5 x 4.5 cm 400 / 50
Print Code: F(1)

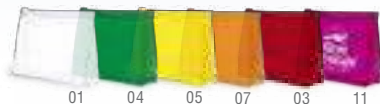

01 04 05 07 03 11

**Fergi 3429**

19

Beauty Bag. PVC.
Kosmetik Tasche. PVC.
Nécessaire. PVC.
Toiletas. PVC.

24 x 21 x 6.5 cm 200 / 50 Print Code: F(1)



01 03 07

**Darak 1812**

22 09

Beauty Bag. PU.
Kosmetik Tasche. PU.
Nécessaire. Similicuir.
Toiletas. PU.

21 x 15 cm 400 / 10 Print Code: F(1)

Roger 1647

Beauty Bag. Rayon Velvet.
Kosmetik Tasche. Rayon Wildleder.
Nécessaire. Suédine Rayon.
Toiletas. Rayon Fluweel.

21 x 14 x 6 cm 400 / 10 Print Code: F(1), N(6)

Rarox 5097

Beauty Bag. Microfibre.
Kosmetik Tasche. Mikrofaser.
Nécessaire. Microfibre.
Toiletas. Microfibre.

19 x 10 x 2.5 cm 500 / 10 Print Code: F(1), N(6), O



Britney 9147

03

Beauty Bag. Polyester 600D.
Kosmetik Tasche. Polyester 600D.
Nécessaire. Polyester 600D.
Toiletas. Polyester 600D.

22 x 14 x 6 cm  300 / 20
Print Code: F(1), N(8), O



02

Trevi 3178

Beauty Bag. Polyester 600D.
Kosmetik Tasche. Polyester 600D.
Nécessaire. Polyester 600D.
Toiletas. Polyester 600D.

21.5 x 14 x 10 cm  200 / 10
Print Code: F(1), N(8), O



13

Espi 4055

Beauty Bag. Polyester 600D.
Kosmetik Tasche. Polyester 600D.
Nécessaire. Polyester 600D.
Toiletas. Polyester 600D.

25 x 16 x 8 cm  100 / 10  Print Code: F(1), N(8), O





Pensol 1644

Pillbox. Bamboo. 3 Compartments.
 Pillendose. Bambus. 3 Abteilungen.
 Pitulier. Bambou. 3 Compartiments.
 Pillendoosje. Bamboe. 3 Compartimenten.

8 x 2.4 x 4 cm 200 / 50 Print Code: C(4), L1, W



Medlar 20698

Pillbox. Bamboo. 7 Compartments.
 Pillendose. Bambus. 7 Abteilungen.
 Pitulier. Bambou. 7 Compartiments.
 Pillendoosje. Bamboe. 7 Compartimenten.

Ø 11 x 3 cm 40 Print Code: C(4), L1, W



Betur 6383

Pillbox. Bamboo Fibre/ PP. 3 Compartments.
 Pillendose. Bambusfaser/ PP. 3 Abteilungen.
 Pitulier. Fibre Bambou/ PP. 3 Compartiments.
 Pillendoosje. Bamboe Fibre/ PP. 3 Compartimenten.

Ø 7.5 x 1.7 cm 500 / 100 Print Code: C(4), W



Varsum 6382

Pillbox. Bamboo Fibre/ PP. 3 Compartments.
 Pillendose. Bambusfaser/ PP. 3 Abteilungen.
 Pitulier. Fibre Bambou/ PP. 3 Compartiments.
 Pillendoosje. Bamboe Fibre/ PP. 3 Compartimenten.

6 x 1.3 x 3.9 cm 1000 / 100 Print Code: C(4), W



Hempix 6680

Antibacterial Pillbox. 3 Compartments.
 Antibakterieel Pillendose. 3 Abteilungen.
 Pitulier Antibacterienne. 3 Compartiments.
 Antibacterieel Pillendoosje. 3 Compartimenten.

6 x 1.3 x 3.9 cm 1000 / 100 Print Code: C(4), W



Trizone 3283

Pillbox. 3 Compartments.
 Pillendose. 3 Abteilungen.
 Pitulier. 3 Compartiments.
 Pillendoosje. 3 Compartimenten.

6 x 1.3 x 3.9 cm 1000 / 100 Print Code: C(4), W



Stexio 20548

Pillbox. 31 Compartments.
Pillendose. 31 Abteilungen.
Pitulier. 31 Compartments.
Pillendoosje. 31 Compartimenten.

28.5 x 10.5 x 3 cm 40 / 20
Print Code: E(1)



Ablix 20547

Pillbox. 28 Compartments.
Pillendose. 28 Abteilungen.
Pitulier. 28 Compartments.
Pillendoosje. 28 Compartimenten.

Ø 9 x 10 cm 50 / 25 Print Code: D(4)

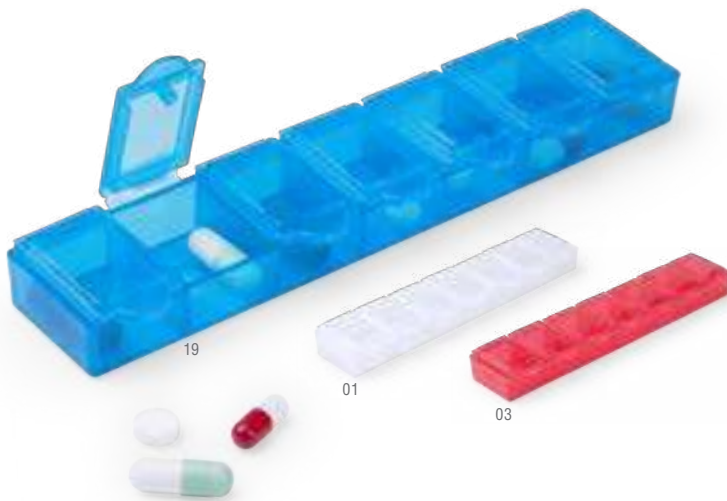

Lucam 5034

Pillbox. 7 Compartments.
Pillendose. 7 Abteilungen.
Pitulier. 7 Compartments.
Pillendoosje. 7 Compartimenten.

15 x 1.6 x 3.3 cm 500 / 50 Print Code: D(1)



Berty 6006

Foldable Cup. PP. 220 ml.
Faltbarer Trinkbecher. PP. 220 ml.
Verre Pliable. PP. 220 ml.
Opvouwbare Beker. PP. 220 ml.

Ø 6.8 x 9 cm 100 Print Code: D(4), W





Aspi 8781

Pillbox. 2 Compartments.
Pillendose. 2 Abteilungen.
Pitulier. 2 Compartiments.
Pillendoosje. 2 Compartimenten.

 9.5 x 1.6 x 4.8 cm  400 / 100
 Print Code: C(4), W



Edmor 6067

Pillbox. 4 Compartments.
Pillendose. 4 Abteilungen.
Pitulier. 4 Compartiments.
Pillendoosje. 4 Compartimenten.

 6 x 1.8 x 6 cm  1000 / 100  Print Code: C(4), W



Astrid 3284

Pillbox. 4 Compartments.
Pillendose. 4 Abteilungen.
Pitulier. 4 Compartiments.
Pillendoosje. 4 Compartimenten.

 Ø 7 x 2.1 cm  500 / 50  Print Code: C(4), W



Alumpill 3168

Keyring Pillbox. Aluminium. 1 Compartment.
Schlüsselanhänger Pillendose. Aluminium. 1 Abteilung.
Porte-Clés Pitulier. Aluminium. 1 Compartiment.
Sleutelhanger Pillendoosje. Aluminium. 1 Compartiment.

 Ø 1.4 x 5.2 cm  500 / 50  Print Code: D(1), L1



New

19

ID BADGE INCLUDED

Fleck 20931

Id Badge Lanyard. Polyester/ PVC.
Namensschild Schlüsselband. Polyester/ PVC.
Lanyard Porte-Badge. Polyester/ PVC.
Badge Lanyard. Polyester/ PVC.

7 x 54 cm 600 / 100 Print Code: G(1), N(8)



01

02

06

03



03

19

01

Kelvin 3696

Digital Thermometer. Button Battery Included.
Digitales Thermometer. Knopfzelle Inklusiv.
Thermomètre Digital. Pile Bouton Inclusive.
Digitale Thermometer. Knoopcel Batterij Inclusief.

2.5 x 14.4 x 1 cm 400 / 50
Print Code: C(1)



01

Doctor 9735

Torch. 1 Led. Button Batteries Included.
Lampe. 1 Led. Knopfzellen Inklusiv.
Lampe. 1 Led. Piles Bouton Inclusive.
Zaklamp. 1 Led. Knoopcel Batterijen Inclusief.

Ø 1.4 x 12.5 cm 500 / 50
Print Code: C(4)



02



Senter 3714

Pen Torch. 1 Led. Button Batteries Included.
Kugelschreiber Lampe. 1 Led. Knopfzellen Inklusiv.
Stylo Lampe. 1 Led. Piles Bouton Inclusive.
Pen-Zaklamp. 1 Led. Knoopcel Batterij Inclusief.

Ø 1.5 x 12.7 cm 500 / 50
Print Code: B(4)



EXTENDABLE 65 CM

Bosur 6489

Id Holder. Extendable. Clip Included.
Namensschild Halter. Ausziehbar. Gürtelclip Inklusiv.
Porte Badge. Extensible. Clip Inclusive.
Id Houder. Verlengbaar. Clip Inclusief.

Ø 3.2 x 1.5 cm 1000 / 100 Print Code: C(4), V



Siluet 9543

Tape Measure. Adjustable Tape 157 cm.
Körpermaßband. Selbststellende Gürtel 157 cm.
Mètre. Ruban Auto-Ajustable 157 cm.
Lichaam-Meetlint. Aanpasbaar Meetlint 157 cm.

8.5 x 5.5 x 2 cm 240 / 24 Print Code: C(4)



19
Medic 3708

Pen.
Kugelschreiber.
Stylo.
Pen.

Ø 1.1 x 12.7 cm 1000 / 50
Print Code: B(4)

03 04 01



Tib 3715

Pen.
Kugelschreiber.
Stylo.
Pen.

Ø 1.8 x 12 cm 1000 / 50 Print Code: B(4)



Tormil 6082

Pocket Protector. PVC.
Taschenschutz. PVC.
Protecteur de Poche. PVC.
Zakbeschermer. PVC.

8.5 x 15 cm 1000 / 50 Print Code: C(1)

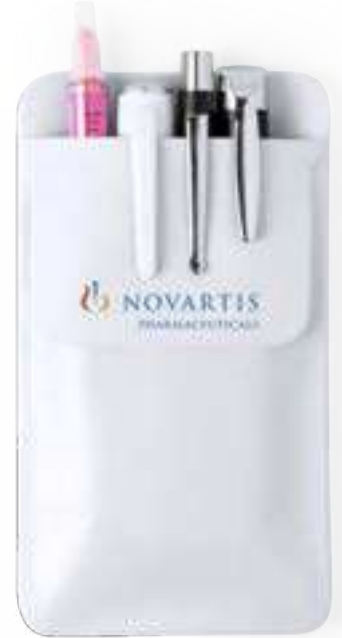

Anti
bacterial



Ramix 6692

Antibacterial Pen.
Antibakteriell Kugelschreiber.
Stylo Antibacterienne.
Antibacterieel Pen.

Ø 1.1 x 14 cm 1000 / 50 Print Code: B(4)



Doret 6721

Antibacterial Pen. Thermometer Function.
Antibakteriell Kugelschreiber. Thermometer Funktion.
Stylo Antibacterienne. Fonction Thermomètre.
Antibacterieel Pen. Thermometer Functie.

Ø 1.1 x 14.5 cm 1000 / 50 Print Code: B(4)



Yak 6656

Multifunction Antibacterial Pen. 3 ml. Liquid Not Included.
Multifunktion Antibakteriell Kugelschreiber. 3 ml. Flüssigkeit Nicht im Lieferumfang.
Stylo Antibacterienne Multifonction. 3 ml. Liquide Non Inclusive.
Multifunctioneel Antibacterieel Balpen. 3 ml. Vloeistof Niet Inclusief.

Ø 1.4 x 15.7 cm 1000 / 50 Print Code: B(4)

**Vixel 6720**

Hydroalcoholic Gel. 30 ml. Skin cleansing solution.
 Hydroalkoholisches Gel. 30 ml. Hautreinigungslösung.
 Gel Hydroalchologique. 30 ml. Solution pour le lavage des mains.
 Hydroalcoholic Gel. 30 ml. Huidreinigende oplossing.

3.9 x 8.3 x 2.3 cm 200 / 50
 Print Code: C(4)

**Bustan 6325**

Hydroalcoholic Gel. 10 ml. Skin cleansing solution.
 Hydroalkoholisches Gel. 10 ml. Hautreinigungslösung.
 Gel Hydroalchologique. 10 ml. Solution pour le lavage des mains.
 Hydroalcoholic Gel. 10 ml. Huidreinigende oplossing.

Ø 1.6 x 14.2 cm 500 / 50
 Print Code: B(4)

**Bradul 6571**

Hydroalcoholic Gel. 15 ml. Skin cleansing solution.
 Hydroalkoholisches Gel. 15 ml. Hautreinigungslösung.
 Gel Hydroalchologique. 15 ml. Solution pour le lavage des mains.
 Hydroalcoholic Gel. 15 ml. Huidreinigende oplossing.

3 x 6.3 x 1.8 cm 500 / 250
 Print Code: C(4), W

**Rokal 6639**

Hydroalcoholic Gel. 60 ml. Skin cleansing solution.
 Hydroalkoholisches Gel. 60 ml. Hautreinigungslösung.
 Gel Hydroalchologique. 60 ml. Solution pour le lavage des mains.
 Hydroalcoholic Gel. 60 ml. Huidreinigende oplossing.

Ø 3.3 x 11 cm 200 / 50
 Print Code: C(1)

**Trikel 6718**

Hydroalcoholic Gel. 30 ml. Skin cleansing solution.
 Hydroalkoholisches Gel. 30 ml. Hautreinigungslösung.
 Gel Hydroalchologique. 30 ml. Solution pour le lavage des mains.
 Hydroalcoholic Gel. 30 ml. Huidreinigende oplossing.

4 x 9.8 x 2.5 cm 200 / 50
 Print Code: C(4)

**Lidem 6643**

Hydroalcoholic Gel. 30 ml. Skin cleansing solution.
 Hydroalkoholisches Gel. 30 ml. Hautreinigungslösung.
 Gel Hydroalchologique. 30 ml. Solution pour le lavage des mains.
 Hydroalcoholic Gel. 30 ml. Huidreinigende oplossing.

3.5 x 10 x 2.2 cm 200 / 50
 Print Code: C(1)

**Flaix 6719**

Hydroalcoholic Gel. Silicone. 30 ml. Skin cleansing solution.
 Hydroalkoholisches Gel. Silikon. 30 ml. Hautreinigungslösung.
 Gel Hydroalchologique. Silicone. 30 ml. Solution pour le lavage des mains.
 Hydroalcoholic Gel. Siliconen. 30 ml. Huidreinigende oplossing.

4 x 8.2 x 2.4 cm 200 / 50
 Print Code: C(4)

19 LET'S PLAY





PLAYING IMAGINING GROWING



Oleox 20978

Art Frame. MDF.
Kunstrahmen. MDF.
Cadre d'art. MDF.
Kunstlijst. MDF.

24 x 33 x 3 cm 20 Print Code: F(1), L2

New





Recycled

CARDBOARD

Mertens 20408

Set. Recycled Cardboard. 8 Pencils. 24 Sheets Notepad.
 Set. Recycling Pappe. 8 Stifte. 24 Blätter Notizblock.
 Set. Carton Recyclé. 8 Crayons. Bloc 24 Feuilles.
 Set. Gerecycled Karton. 8 Potloden. 24 Blaadjes Notepad.

 21.5 x 18.5 x 1 cm  50 / 25
 Print Code: E(1)



Tynie 4456

Pencil Set. Recycled Cardboard. 4 Pencils.
 Bleistiftbox. Recycling Pappe. 4 Stifte.
 Boîte Crayons. Carton Recyclé. 4 Crayons.
 Potlood Set. Gerecycled Karton. 4 Potloden.

 3 x 9 x 0.8 cm  1000 / 50  Print Code: B(4)



Girls 8585

Pencil Set. Recycled Cardboard. 6 Pencils.
 Bleistiftbox. Recycling Pappe. 6 Stifte.
 Boîte Crayons. Carton Recyclé. 6 Crayons.
 Potlood Set. Gerecycled Karton. 6 Potloden.

 4.5 x 9 x 0.8 cm  500 / 25  Print Code: B(4)



Boys 8584

Pencil Set. Recycled Cardboard. 12 Pencils.
 Bleistiftbox. Recycling Pappe. 12 Stifte.
 Boîte Crayons. Carton Recyclé. 12 Crayons.
 Potlood Set. Gerecycled Karton. 12 Potloden.

 9 x 9 x 1 cm  250 / 25  Print Code: B(4), W

Seed Paper

New

New

New



Elaris 20372

Seeds Set. Seed Paper. 8 Pieces. 20 Sheets Notepad. Petunia Seeds Included. Assorted Coloured Flowers.

Samen Set. Samenpapier. 8 Stuks. 20 Blätter Notizblock. Petuniensamen Inklusief. In verschillende Farben.

Set Ensemencé. Papier Ensemencé. 8 Pièces. Bloc 20 Feuilles. Graines de Pétunia Incluses. Fleurs Couleurs Diverses.

Zaad Set. Zaadpapier. 8 Stuks. 20 Blaadjes Notepad. Petunia Zaden Inclusief. Assortiment van Gekleurde Bloemen.

7.4 x 9 x 1.5 cm 400 / 50 Print Code: B(4)



Fyser 20371

Seeds Crayon Set. Seed Paper. 6 Crayons. Petunia Seeds Included. Assorted Coloured Flowers.

Samen Wachsmalstifte Set. Samenpapier. 6 Wachsmalstifte. Petuniensamen Inklusief. In verschillende Farben.

Boîte Crayons Ensemencé. Papier Ensemencé. 6 Crayons. Graines de Pétunia Incluses. Fleurs Couleurs Diverses.

Zaad Wasco Set. Zaadpapier. 6 Krijtjes. Petunia Zaden Inclusief. Assortiment van Gekleurde Bloemen.

5.3 x 9 x 0.9 cm 250 / 25 Print Code: B(4)



Delar 20370

Seeds Pencil Set. Seed Paper. 6 Pencils. Petunia Seeds Included. Assorted Coloured Flowers.

Samen Bleistiftbox. Samenpapier. 6 Stifte. Petuniensamen Inklusief. In verschillende Farben.

Boîte Crayons Ensemencé. Papier Ensemencé. 6 Crayons. Graines de Pétunia Incluses. Fleurs Couleurs Diverses.

Zaad Potlood Set. Zaadpapier. 6 Potloden. Petunia Zaden Inclusief. Assortiment van Gekleurde Bloemen.

4.5 x 9 x 0.8 cm 500 / 25 Print Code: B(4)

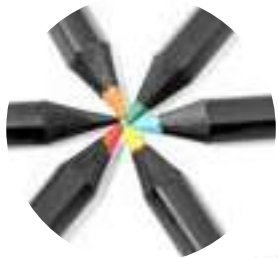

New



Lameiro 21090

Pencil Set. Recycled Cardboard. 6 Pencils. Bleistiftbox. Recycling Pappe. 6 Stifte.

Boîte Crayons. Carton Recyclé. 6 Crayons. Potlood Set. Gerecycled Karton. 6 Potloden.

4.5 x 9 x 0.8 cm 500 / 25 Print Code: B(1)

Recycled Cardboard Black Line



New

Durcax 21089

Set. Recycled Cardboard. 7 Pieces. Set. Recycling Pappe. 7 Stück.

Set. Carton Recyclé. 7 Pièces. Set. Gerecycled Karton. 7 Potloden.

Ø 2.7 x 10.6 cm 400 / 50 Print Code: B(1)

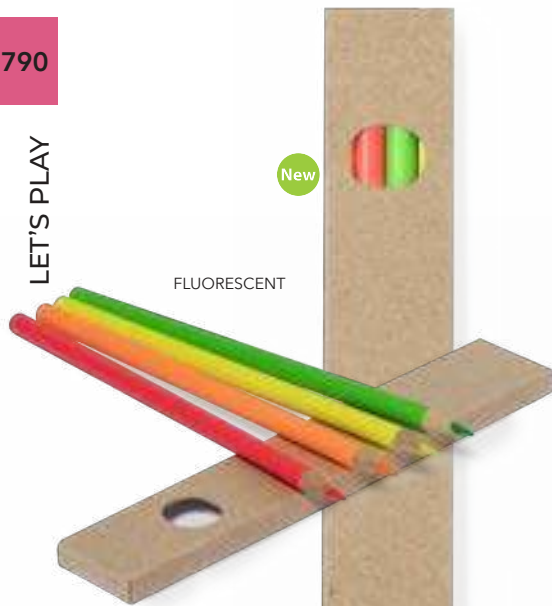

FLUORESCENT

Tucker 20406

Pencil Set. Recycled Cardboard. 4 Pencils.
Bleistiftbox. Recycling Pappe. 4 Stifte.
Boîte Crayons. Carton Recyclé. 4 Crayons.
Potlood Set. Gerecycled Karton. 4 Potloden.

3 × 18 × 0.9 cm 300 / 50 Print Code: B(4), W



Baby 9162

Set. Recycled Cardboard. 7 Pieces.
Set. Recycling Pappe. 7 Stück.
Set. Carton Recyclé. 7 Pièces.
Set. Gerecycled Karton. 7 Potloden.

Ø 2.7 × 10.2 cm 400 / 50 Print Code: B(4), W



Aladín 8722

Set. Recycled Cardboard. 19 Pieces.
Set. Recycling Pappe. 19 Stück.
Set. Carton Recyclé. 19 Pièces.
Set. Gerecycled Karton. 19 Stuks.

7.8 × 18.5 × 1.2 cm 200 / 25 Print Code: B(4)



Pichi 8719

Crayon Set. Recycled Cardboard. 6 Crayons.
Wachsmalstifte Set. Recycling Pappe. 6 Wachsmalstifte.
Boîte Crayons. Carton Recyclé. 6 Crayons.
Wasco Set. Gerecycled Karton. 6 Krijtjes.

5.3 × 9 × 0.9 cm 250 / 25 Print Code: B(4)



Pixi 3641

Set. Recycled Cardboard. 13 Pieces.
Set. Recycling Pappe. 13 Stück.
Set. Carton Recyclé. 13 Pièces.
Set. Gerecycled Karton. 13 Stuks.

Ø 4.6 × 10 cm 200 / 10 Print Code: B(4), W

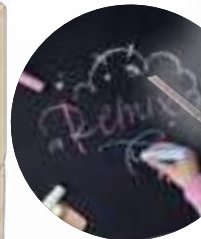

Remix 6083

Chalk Set. Recycled Cardboard. 4 Chalks.
Kreiden Set. Recycling Pappe. 4 Kreiden.
Set Craies. Carton Recyclé. 4 Craies.
Krijtjes Set. Gerecycled Karton. 4 Krijtjes.

9.5 × 11 × 2.5 cm 100 / 50 Print Code: B(4)



Figgy 4455

Set. Recycled Cardboard. 8 Pieces. 20 Sheets Notepad.
Set. Recycling Papper. 8 Stück. 20 Blätter Notizblock.
Set. Carton Recyclé. 8 Pièces. Bloc 20 Feuilles.
Set. Gerecycled Karton. 8 Stuks. 20 Blaadjes Notepad.

7.4 x 9 x 1.5 cm 400 / 50 Print Code: B(4), W

Lauglin 1522

Set. Recycled Cardboard. 12 Pencils. 36 Sheets Notepad.
Set. Recycling Papper. 12 Stifte. 36 Blätter Notizblock.
Set. Carton Recyclé. 12 Crayons. Bloc 36 Feuilles.
Set. Gerecycled Karton. 12 Potloden. 36 Blaadjes Notepad.

9.5 x 9.5 x 1.3 cm 200 / 50 Print Code: B(4)

Clumber 20368

Set. Recycled Cardboard. 9 Pieces. 20 Sheets Notepad.
Set. Recycling Papper. 9 Stück. 20 Blätter Notizblock.
Set. Carton Recyclé. 9 Pièces. Bloc 20 Feuilles.
Set. Gerecycled Karton. 9 Stuks. 20 Blaadjes Notepad.

21 x 20 x 1.5 cm 50 / 25
Print Code: F(1)



Garten 9830

Pencil Set. Cardboard. 6 Pencils.
Bleistiftbox. Papper. 6 Stifte.
Boîte Crayons. Carton. 6 Crayons.
Potlood Set. Karton. 6 Potloden.

5 x 9.3 x 0.8 cm 500 / 50
Print Code: B(4), W

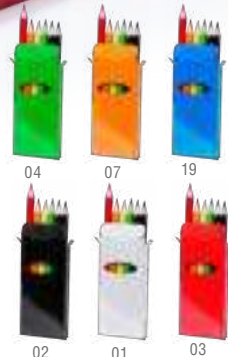

Tune 9831

Crayon Set. Cardboard. 6 Crayons.
Wachsmalstifte Set. Papper. 6 Wachsmalstifte.
Boîte Crayons. Carton. 6 Crayons.
Wasco Set. Karton. 6 Krijtjes.

5 x 8.3 x 0.8 cm 400 / 50 Print Code: B(4), W





Lanzini 20407

Pencil Case. Wood. 66 Pieces.
 Federmappe. Holz. 66 Stück.
 Trousse. Bois. 66 Pièces.
 Etui. Hout. 66 Stuks.

📏 28 × 4.2 × 21 cm 📦 20 🔄 Print Code: F(1), L2, W



Trinen 4907

Pencil Case. 29 Pieces.
 Federmappe. 29 Stück.
 Trousse. 29 Pièces.
 Etui. 29 Stuks.

📏 18 × 18.5 × 3.5 cm 📦 50 🔄 Print Code: D(1)



Migal 5139

Pencil Case. Polyester 420D. 10 Pieces.
 Federmappe. Polyester 420D. 10 Stück.
 Trousse. Polyester 420D. 10 Pièces.
 Etui. Polyester 420D. 10 Stuks.

📏 4.5 × 10 × 4 cm 📦 400 / 10 🔄 Print Code: F(1), N(8)



01 05 04 03



Clown 9710

Pencil Case. 14 Pieces.
 Federmappe. 14 Stück.
 Trousse. 14 Pièces.
 Etui. 14 Stuks.

📏 9.6 × 13.8 × 2.5 cm 📦 144 / 24 🔄 Print Code: D(4)



19 03

sustainable pencil case

793

LET'S PLAY



Dragon 3386



SHARPENED

Pencil Set. Wood. 6 Pencils.
Bleistiftbox. Holz. 6 Stifte.
Boîte Crayons. Bois. 6 Crayons.
Potlood Set. Hout. 6 Potlooden.

20.5 x 2.5 x 3.5 cm 200 / 50 Print Code: D(2), L2



Palermo 6942



UNSHARPENED

Pencil Case. Wood. 5 Pieces.
Federmappe. Holz. 5 Stück.
Trousse. Bois. 5 Pièces.
Etui. Hout. 5 Stuks.

20 x 3.7 x 4.4 cm 200 / 10 Print Code: F(1), L1



Dony 3643



UNSHARPENED

Set. Recycled Cardboard. 6 Pieces.
Set. Recycling Pappe. 6 Stück.
Set. Carton Recyclé. 6 Pièces.
Set. Gerecycled Karton. 6 Stuks.

4.5 x 17.7 x 1.3 cm 240 / 20 Print Code: B(4), W



Dernol 6607



UNSHARPENED

Set. 5 Pieces.
Set. 5 Stück.
Set. 5 Pièces.
Set. 5 Stuks.

3.5 x 19 cm 200 / 50 Print Code: B(4), W



WHEAT STRAW



New

Elyndor 20387



Set. Wheat Straw/ ABS. 5 Pieces.

Set. Weizenstroh/ ABS. 5 Stück.

Set. Paille de Blé/ ABS. 5 Pièces.

Set. Tarwestro/ ABS. 5 Stuks.

20 x 2.2 x 5.6 cm 100 / 50

Print Code: C(1), W



Frensi 20380



Set. Wheat Straw/ ABS. 5 Pieces.

Set. Weizenstroh/ ABS. 5 Stück.

Set. Paille de Blé/ ABS. 5 Pièces.

Set. Tarwestro/ ABS. 5 Stuks.

21 x 4 x 1.6 cm 200 / 50

Print Code: D(1)



Nixora 20379

Ruler. Wheat Straw/ ABS. 30 cm.

Lineal. Weizenstroh/ ABS. 30 cm.

Règle. Paille de Blé/ ABS. 30 cm.

Liniaal. Tarwestro/ ABS. 30 cm.

30.7 x 4 x 0.3 cm 500 / 100

Print Code: D(1), W



New



Marfik 6167

Pencil Case. Jute/ Cotton. 5 Pieces.
 Federmappe. Jutestoff/ Baumwolle. 5 Stück.
 Trousse. Jute/ Coton. 5 Pièces.
 Etui. Jute/ Katoen. 5 Stuks.

19 x 8.5 cm 200 / 50
 Print Code: F(1), N(8)



Cindris 20386

Set. 18 Pieces. 50 Sheets Notepad. Cotton Pouch.
 Set. 18 Stück. 50 Blätter Notizblock. Baumwolle. Etui.
 Set. 18 Pièces. Bloc 50 Feuilles. Étui Coton.
 Set. 18 Stuks. 50 Blaadjes Notepad. Katoen Zakje.

24 x 34 x 2 cm 30 Print Code: F(1), G(6), N(8), O, P



RPET ♻️



Mayfil 1524

Apron. Non-Woven RPET. One Size. Kids. 5 Markers Included.
Schürze. Non-Woven RPET. Einheitsgröße. Kinder. 5 Marker inklusive.
Tablier. T.N.T. RPET. Taille Unique. Enfant. 5 Marqueurs Incluses.
Schort. Non-Woven RPET. Eén Maat. Kind. 5 Stiften inclusief.

43 x 43 cm 200 / 50 Print Code: G(1)



Balard 1526

Drawstring Bag. Non-Woven RPET. 5 Crayons Included.
Rucksack. Non-Woven RPET. 5 Wachsmalstifte inklusive.
Sac à Dos. T.N.T. RPET. 5 Crayons Incluses.
Rugzak. Non-Woven RPET. 5 Krijtjes Inclusief.

25 x 30 cm 200 / 50 Print Code: G(1)



Thurman 1525

Pencil Case. Non-Woven RPET. 5 Crayons Included.
Federmappe. Non-Woven RPET. 5 Wachsmalstifte inklusive.
Trousse. T.N.T. RPET. 5 Crayons Incluses.
Etui. Non-Woven RPET. 5 Krijtjes Inclusief.

22 x 11 cm 200 / 50 Print Code: G(1)



TIME TO
Play!



Yumbi 6360

Kite. Polyester 190T. 4 Crayons Included.
Drachen. Polyester 190T. 4 Wachsmalstifte Inklusive.
Cerf-Volant. Polyester 190T. 4 Crayons Inclusive.
Vlieger. Polyester 190T. 4 Krijtjes Inclusief.

49 x 60 cm 200 / 10 Print Code: G(1)



Mosby 5439

Bag. Non-Woven. 5 Crayons Included.
Tasche. Non-Woven. 5 Wachsmalstifte Inklusive.
Sac. T.N.T.. 5 Crayons Inclus.
Tas. Non-Woven. 5 Krijtjes Inclusief.

20.5 x 22 cm 100 / 50 Print Code: G(1)



Skinga 5703

Pencil Case. Non-Woven. 5 Crayons Included.
Federmappe. Non-Woven. 5 Wachsmalstifte Inklusive.
Trousse. T.N.T.. 5 Crayons Inclus.
Etui. Non-Woven. 5 Krijtjes Inclusief.

22 x 11 cm 200 / 50 Print Code: G(1)



Wizzy 5701

Drawstring Bag. Non-Woven. 5 Crayons Included.
Rucksack. Non-Woven. 5 Wachsmalstifte Inklusive.
Sac à Dos. T.N.T.. 5 Crayons Inclus.
Rugzak. Non-Woven. 5 Krijtjes Inclusief.

25 x 30 cm 200 / 50 Print Code: G(1)

 **WHEAT
STRAW**

New



Ashen 20369

Frisbee. Wheat Straw/ ABS. 6 Markers Included.
Frisbie. Weizenstroh/ ABS. 6 Markers Inklusive.
Frisbee. Paille de Blé/ ABS. 6 Marqueurs Incluses.
Frisbie. Tarwestro/ ABS. 6 Stiften inclusief.

 Ø 1.8 x 23 cm  100 / 50  Print Code: F(1)



320 ml



Fesient 6020

Mug. PS/PP. 320 ml. 4 Pencils and 4 Sheets Included.
Tasse. PS/PP. 320 ml. 4 Stifte und 4 Seiten Inklusive.
Tasse. PS/PP. 320 ml. 4 Crayons et 4 Feuilles Incluse.
Mok. PS/PP. 320 ml. 4 Potloden en 4 Blaadjes Inclusief.

 Ø 8.6 x 10.2 cm  36  Print Code: F(1)



350 ml



01

Colorful 3272

Mug. Ceramic. 350 ml. Chalk Included.
Tasse. Keramik. 350 ml. Kreide Inklusive.
Tasse. Céramique. 350 ml. Craie Incluse.
Mok. Keramiek. 350 ml. Krijtje Inclusief.

 Ø 8.2 x 9.6 cm  36  Print Code: F(1)



BIG LITTLE MUSICIAN!



Nultyn 1529

Xylophone. Wood/ Metal.
Xylophon. Holz/ Metall.
Xylophone. Bois/ Métal.
Xylofoon. Hou/ Metaal.

24 x 2.7 x 12.3 cm 50 Print Code: F(1), L1



Hamelin 1527

Recorder. Bamboo.
Flûte. Bambus.
Flûte. Bambou.
Fluit. Bamboe.

Ø 1.9 x 30 cm 100 / 25 Print Code: E(1), L1



Blues 1528

Harmonica. Wood. Non-Woven Pouch.
Mundharmonika. Holz. Non-Woven Etui.
Harmonica. Bois. Étui T.N.T..
Harmonica. Hout. Non-Woven Zakje.

13 x 2.1 x 2.7 cm 200 / 100 Print Code: E(1), L1



Snaider 20409

Whistle. Wood.
Pfeife. Holz.
Sifflet. Bois.
Fluitje. Hout.

3 x 9 x 1.8 cm 400 / 100
 Print Code: C(4), L1, W

New



Jasara 20401

Money Box. Wood.
Sparschwein. Holz.
Tirelire. Bois.
Spaarpot. Hout.

17.5 x 12.5 x 3 cm 20 / 10
 Print Code: D(1), L2

BAMBOO
FIBRE

Darfil 6379

Money Box. Bamboo Fibre/ ABS.
Sparschwein. Bambusfaser/ ABS.
Tirelire. Fibre Bambou/ ABS.
Spaarpot. Bamboe Fibre/ ABS.

10 x 6.8 x 7.1 cm 100 / 10 Print Code: D(4)



04

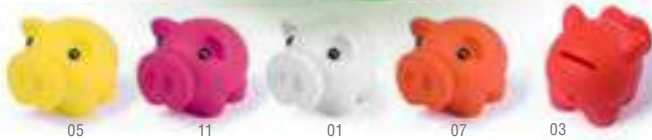

05

11

01

07

03

Donax 4615

Money Box. PVC.
Sparschwein. PVC.
Tirelire. PVC.
Spaarpot. PVC.

10 x 7.5 x 8 cm 100 / 10 Print Code: D(1)



19



04



01



03

Hippo 1664

Money Box. PVC.
Sparschwein. PVC.
Tirelire. PVC.
Spaarpot. PVC.

9 x 14 x 9 cm 100 / 50 Print Code: D(1)





13

18

Sindler 1523

Teddy. Polyester.
Teddy. Polyester.
Peluche. Polyester.
Teddybear. Polyester.

16 x 16 x 12 cm 150 / 10 Print Code: E(1), N(8)



New

Chamox 20400

Teddy. Polyester.
Teddy. Polyester.
Peluche. Polyester.
Teddybear. Polyester.

11 x 12 x 10 cm 150 / 10 Print Code: E(1), N(8)



19

02

01



03

Loony 6497

Teddy. Polyester.
Teddy. Polyester.
Peluche. Polyester.
Teddybear. Polyester.

16 x 16 x 12 cm 150 / 10
Print Code: E(1), N(8)



04

05

19

07



03

Tedchain 9891

Keyring Teddy. Polyester.
Schlüsselanhänger Teddy. Polyester.
Porte-Clés Peluche. Polyester.
Sleutelhanger Teddybear. Polyester.

6.5 x 7.5 x 4 cm 500 / 20 Print Code: E(1), N(8)

New



Ruby 20412

Bib. Cotton/ PEVA. Velcro Closure.
 Lätzchen. Baumwolle/ PEVA. Klettverschluss.
 Bavoir. Coton/ PEVA. Fermeture Velcro.
 Slabbetje. Katoen/ PEVA. Klittenband Stutting.

19.5 x 27 cm 500 / 50 Print Code: D(1), N(8), O, P



100 x 75 cm

Yogui 4721

Blanket. Polar Fleece 200 g/ m2. Anti-Pilling.
 Decke. Polar Fleece 200 g/ m2. Anti-Pilling.
 Couverture. Polaire 200 g/ m2. Anti-Pilling.
 Deken. Polar Fleece 200 g/ m2. Anti-Pilling.

18 x 25 x 9 cm 50 Print Code: N(8)



SOFT Doudou



Marlin 20410

Doudou. Polyester.
Kuscheltier. Polyester.
Doudou. Polyester.
Knuffel. Polyester.

34 x 37 cm 200 / 50 Print Code: N(8), P

Turam 20411

Doudou. Polyester.
Kuscheltier. Polyester.
Doudou. Polyester.
Knuffel. Polyester.

33 x 37 cm 500 / 50 Print Code: N(8), P



Clavier 1517

Puzzles Set. Recycled Cardboard. 2 Puzzles 12 Pieces.
 Puzzles Set. Recycling Pappé. 2 Puzzles 12 Stück.
 Set Puzzles. Carton Recyclé. 2 Puzzles 12 Pièces.
 Puzzel Set. Gerecycled Karton. 2 Puzzels 12 Stuks.

15.5 x 1 x 10.5 cm 100 / 25
 Print Code: D(1), W

Recycled
 CARDBOARD



Sutrox 5719

Puzzle. Wood. 9 Pieces.
 Puzzle. Holz. 9 Stück.
 Puzzle. Bois. 9 Pièces.
 Puzzel. Hout. 9 Stuks.

14.6 x 14.6 x 0.5 cm 200 / 50
 Print Code: D(1), W



Zeta 3301

Puzzle. Cardboard. 24 Pieces. 4 Crayons Included.
 Puzzle. Pappé. 24 Stück. 4 Wachsmalstifte Inklusiv.
 Puzzle. Carton. 24 Pièces. 4 Crayons Incluses.
 Puzzel. Karton. 24 Stuks. 4 Krijtjes Inclusief.

15 x 10 x 0.3 cm 200 / 20
 Print Code: D(1), W



Mazinger 9321

Mini Puzzle.
 Mini Puzzle.
 Mini Puzzle.
 Mini Puzzel.

7.5 x 9 x 0.6 cm 500 / 50
 Print Code: B(4), W



TIME TO
Play!



Mirman 1519

Game. Recycled Cardboard. 36 Pieces.
Spiel. Recycling Pappe. 36 Stück.
Jeu. Carton Recyclé. 36 Pièces.
Spel. Gerecycled Karton. 36 Stuks.

6 x 8.9 x 1.3 cm 200 / 50 Print Code: B(1)



Lauby 1518

Game. MDF. 24 Pieces. Cotton Pouch.
Spiel. MDF. 24 Stück. Baumwolle Etui.
Jeu. MDF. 24 Pièces. Étui Coton.
Spel. MDF. 24 Stuks. Katoen Zakje.

8 x 10 cm 300 / 50
Print Code: F(1), N(8)



Fornot 20161

Game. Cork. 10 Pieces. Cotton Pouch.
Spiel. Kork. 10 Stück. Baumwolle Etui.
Jeu. Liège. 10 Pièces. Étui Coton.
Spel. Kurk. 10 Stuks. Katoen Zakje.

12.5 x 15.5 cm 200 / 50
Print Code: F(1), B(1), L1, N(8)





New



Wolen 20405

Game. Wood. 10 Pieces.
 Spiel. Holz. 10 Stück.
 Jeu. Bois. 10 Pièces.
 Spel. Hout. 10 Stuks.

34.5 x 2.3 x 21.5 cm

20

Print Code: E(2), L2



Helmet 1483

Mini Table Football. Wood/ Wheat Straw/ PS. 2 Balls Included.
 Mini Kicker. Holz/ Weizenstroh/ PS. 2 Bälle inklusive.
 Mini Babyfoot. Bois/ Paille de Blé/ PS. 2 Balles incluses.
 Mini Tafelvoetbal. Hout/ Tarwestro/ PS. 2 Ballen inclusief.

36.5 x 9.5 x 32 cm

5

Print Code: K(1)





Madis 20404

Game. Wood. 5 Pieces.
Spiel. Holz. 5 Stück.
Jeu. Bois. 5 Pièces.
Spel. Hout. 5 Stuks.

37 x 7 x 10 cm 20 Print Code: E(1), L2



Tumble 1505

Game. Wood. 4 Pieces.
Spiel. Holz. 4 Stück.
Jeu. Bois. 4 Pièces.
Spel. Hout. 4 Stuks.

18 x 10 x 7.7 cm 50 Print Code: D(4), L2, W



Strike 1342

Minigame Bowling. Wood.
Mini-Spiel Bowling. Holz.
Mini-Jeu Bowling. Bois.
Minispiel Bowling. Hout.

30 x 4.5 x 10 cm 20 Print Code: G(1), L2

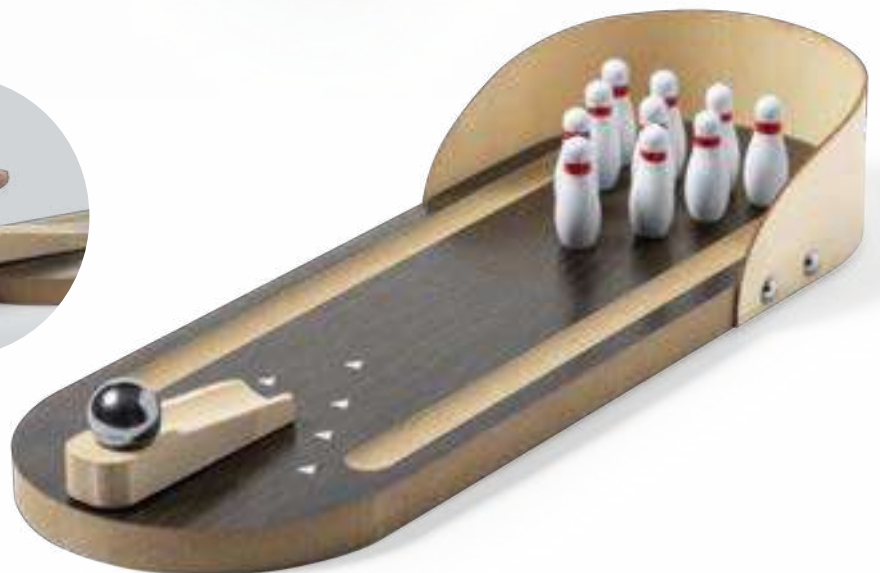

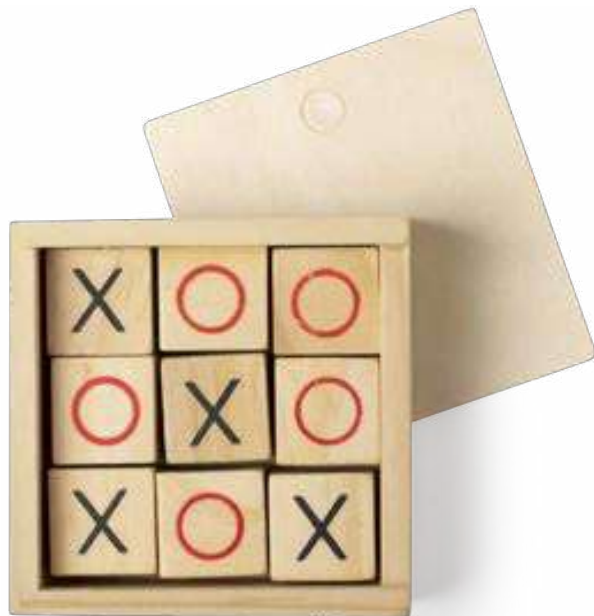

Grapex 6417

Game. Wood. 9 Pieces.
Spiel. Holz. 9 Stück.
Jeu. Bois. 9 Pièces.
Spel. Hout. 9 Stuks.

73 × 3.1 × 7.3 cm 200 / 50
Print Code: D(2), L1, W



New



Crested 20383

Skill Game. Wood. 16 Pieces.
Geschicklichkeitsspiel. Holz. 16 Stück.
Jeu d'Habileté. Bois. 16 Pièces.
Behendigheidsspel. Hout. 16 Stuks.

8.6 × 3 × 8.6 cm 100 / 50
Print Code: D(2), L1, W



Bucher 20402

Skill Game. Wood.
Geschicklichkeitsspiel. Holz.
Jeu d'Habileté. Bois.
Behendigheidsspel. Hout.

9 × 2.5 × 9 cm 100 / 50
Print Code: C(4), L1



Griffon 20396

Skill Game. Wood.
Geschicklichkeitsspiel. Holz.
Jeu d'Habileté. Bois.
Behendigheidsspel. Hout.

5.7 × 3.8 × 2.3 cm 500 / 100
Print Code: C(1), L1



Milie 1521

Skill Game. Wood. Cotton Pouch.
Geschicklichkeitsspiel. Holz. Baumwolle Etui.
Jeu d'Habileté. Bois. Étui Coton.
Behendigheidsspel. Hout. Katoen Zakje.

11.1 × 4.7 × 5.2 cm 100 / 50
Print Code: G(1), L1, N(8)



New



New



Sudoku 20189

Skill Game. Wood. 81 Pieces.
Geschicklichkeitsspiel. Holz. 81 Stück.
Jeu d'Habileté. Bois. 81 Pièces.
Behendigheidsspel. Hout. 81 Stuks.

📏 20 x 3.5 x 20 cm 📦 30
🔗 Print Code: D(2), L2, W



Thumper 20403

Game. Wood. 17 Pieces. Cotton Pouch.
Spiel. Holz. 17 Stück. Baumwolle Etui.
Jeu. Bois. 17 Pièces. Étui Coton.
Spel. Hout. 17 Stuks. Katoen Zakje.

📏 12 x 12 x 1.5 cm 📦 100 / 50
🔗 Print Code: D(2), F(1), L1, N(8)



Parchess 6932

Game Set. Wood. 3 Games.
Spiel Set. Holz. 3 Spiele.
Set Jeu. Bois. 3 Jeux.
Spel Set. Hout. 3 Spelen.

📏 12.5 x 3 x 12.5 cm 📦 100 / 50
🔗 Print Code: D(2), L2, W



Mikado 5718

Skill Game. Wood. 41 Pieces.
Geschicklichkeitsspiel. Holz. 41 Stück.
Jeu d'Habileté. Bois. 41 Pièces.
Behendigheidsspel. Hout. 41 Stuks.

📏 19.3 x 2.5 x 4.1 cm 📦 100 / 50
🔗 Print Code: D(2), L2, W

CHESS, DRAUGHTS,
AND LUDO



Genium 5525

Skill Games Set. Wood. 3 Games.
Geschicklichkeitsspiele Set. Holz. 3 Spiele.
Set Jeux d' 'Habilités. Bois. 3 Jeux.
Behendigheidsspel Set. Hout. 3 Spelen.

16.3 x 6 x 6.4 cm 50 Print Code: D(2), L2, W



Tayex 6782

Skill Game. Wood. 7 Pieces. Cotton Pouch.
Geschicklichkeitsspiel. Holz. 7 Stück. Baumwolle Etui.
Jeu d' 'Habilité. Bois. 7 Pièces. Étui Coton.
Behendigheidsspel. Hout. 7 Stuks. Katoen Zakje.

4.5 x 4.5 x 4.5 cm 200 / 100 Print Code: G(1), N(8)

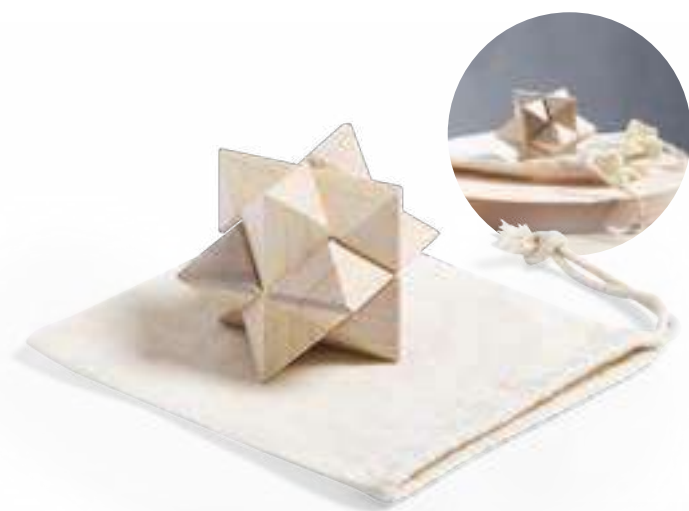

Bruffy 6781

Skill Game. Wood. 6 Pieces. Cotton Pouch.
Geschicklichkeitsspiel. Holz. 6 Stück. Baumwolle Etui.
Jeu d' 'Habilité. Bois. 6 Pièces. Étui Coton.
Behendigheidsspel. Hout. 6 Stuks. Katoen Zakje.

5 x 5 x 5 cm 200 / 100 Print Code: G(1), N(8)



Cusack 20395

Skill Game. Bamboo. 6 Pieces.
Geschicklichkeitsspiel. Bambus. 6 Stück.
Jeu d' 'Habilité. Bambou. 6 Pièces.
Behendigheidsspel. Bamboe. 6 Stuks.

4.5 x 4.5 x 4.5 cm 500 / 100 Print Code: C(1)



Charlis 1507

Skill Game. Wood. 13 Pieces.
Geschicklichkeitsspiel. Holz. 13 Stück.
Jeu d'Habileté. Bois. 13 Pièces.
Behendigheidsspel. Hout. 13 Stuks.

14.4 x 3 x 14.4 cm 40 Print Code: D(2), L2, W



Sabix 6419

Game. Wood. 45 Pieces. Cotton Pouch.
Spiel. Holz. 45 Stück. Baumwolle Etui.
Jeu. Bois. 45 Pièces. Étui Coton.
Spel. Hout. 45 Stuks. Katoen Zakje.



5.7 x 17 x 5.7 cm 50 Print Code: G(1), N(8), L1

Ketel 1506

Skill Game. Wood. 4 Pieces. Cotton Pouch.
Geschicklichkeitsspiel. Holz. 4 Stück. Baumwolle Etui.
Jeu d'Habileté. Bois. 4 Pièces. Étui Coton.
Behendigheidsspel. Hout. 4 Stuks. Katoen Zakje.



9 x 12 cm 200 / 50 Print Code: G(1), L2, N(8)

Gary 6985

Skill Game. Wood. Cotton Pouch.
Geschicklichkeitsspiel. Holz. Baumwolle Etui.
Jeu d'Habileté. Bois. Étui Coton.
Behendigheidsspel. Hout. Katoen Zakje.



29 x 1.7 x 1.3 cm 200 / 100 Print Code: G(1), N(8)



New

Jatrex 20399

Mini Puzzle. Wood. 9 Pieces.
Mini Puzzle. Holz. 9 Stück.
Mini Puzzle. Bois. 9 Pièces.
Mini Puzzel. Hout. 9 Stuks.

7.5 x 12 x 1.2 cm 100 / 25
 Print Code: C(1), L1



Tangram 3704

Puzzle. Wood. 7 Pieces.
Puzzle. Holz. 7 Stück.
Puzzle. Bois. 7 Pièces.
Puzzel. Hout. 7 Stuks.

9.8 x 9.8 x 0.7 cm 400 / 100 Print Code: E(1), L1

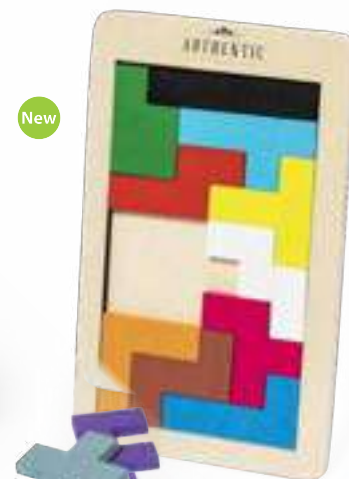

New

Brodix 20394

Skill Game. Wood. 12 Pieces.
Geschicklichkeitsspiel. Holz. 12 Stück.
Jeu d'Habileté. Bois. 12 Pièces.
Behendigheidsspel. Hout. 12 Stuks.

15.8 x 9.4 x 0.5 cm 300 / 100 Print Code: E(1), L1

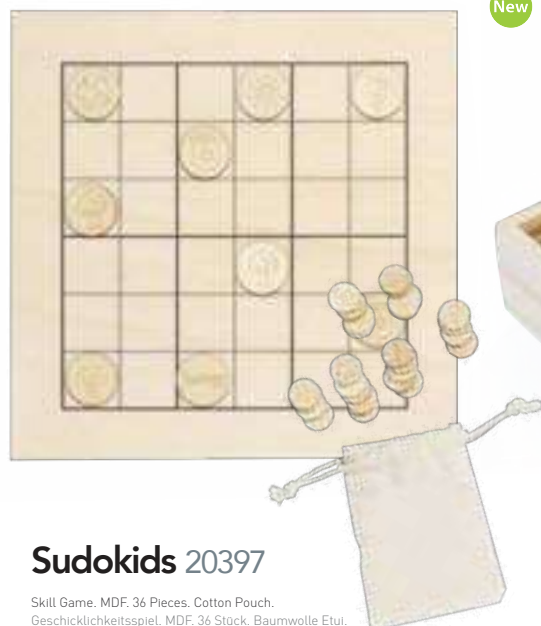

Sudokids 20397

Skill Game. MDF. 36 Pieces. Cotton Pouch.
Geschicklichkeitsspiel. MDF. 36 Stück. Baumwolle Etui.
Jeu d'Habileté. MDF. 36 Pièces. Étui Coton.
Behendigheidsspel. MDF. 36 Stuks. Katoen Zakje.

17 x 17 x 2.7 cm 100 / 25 Print Code: F(1), D(1), L1, N(8)

New



Kelpet 5716

Dominoes. Wood. 28 Pieces.
Domino. Holz. 28 Stück.
Dominos. Bois. 28 Pièces.
Domino. Hout. 28 Stuks.

15 x 3 x 5 cm 100 / 50
 Print Code: D(4), L2, W



Mates 1520

Game. Wood. 32 Pieces. Cotton Pouch.
Spiel. Holz. 32 Stück. Baumwolle Etui.
Jeu. Bois. 32 Pièces. Étui Coton.
Spel. Hout. 32 Stuks. Katoen Zakje.

8.6 x 11.3 x 1.5 cm 300 / 50 Print Code: F(1), N(8)



Gupy 1508

Spinning Top. Wood.
Kreisel. Holz.
Toupie. Bois.
Draaiende Top. Hout.

📏 Ø 4.8 x 7.6 cm 📦 200 / 50 🏷️ Print Code: D(1), L1



Cretium 5715

Yoyo. Wood.
Yoyo. Holz.
Yoyo. Bois.
Jojo. Hout.

📏 Ø 5 x 2.8 cm 📦 300 / 50 🏷️ Print Code: C(4), L1, W

BAMBOO
FIBRE



Runux 6380

Yoyo. Bamboo Fibre/ PP.
Yoyo. Bambusfaser/ PP.
Yoyo. Fibre Bambou/ PP.
Jojo. Bamboe Fibre/ PP.

📏 Ø 5 x 1.5 cm 📦 500 / 100 🏷️ Print Code: C(4), W



Milux 4418

Yoyo.
Yoyo.
Yoyo.
Yoyo.

📏 Ø 5 x 1.5 cm 📦 500 / 100 🏷️ Print Code: C(4), W



04

WHEAT
STRAW



Dopey 20385

Yoyo. Wheat Straw/ ABS.
Yoyo. Weizenstroh/ ABS.
Yoyo. Paille de Blé/ ABS.
Jojo. Tarwestro/ ABS.

📏 Ø 5.4 x 3.5 cm 📦 250 / 50 🏷️ Print Code: C(4), W



Kerchak 20373

Dartball Board. Polyester. 3 Balls Included.
Dartschreibe. Polyester. 3 Bälle Inklusive.
Cible. Polyester. 3 Balles Inclusives.
Dartbal Bord. Polyester. 3 Ballen Inclusief.

📏 Ø 28.5 cm 📦 100 / 50 🗑️ Print Code: F(1), N(8)



Jordan 3920

Basket. PVC. Ball Included.
Basketball. PVC. Ball Inklusive.
Panier de Basket. PVC. Sphère Inclusive.
Mand. PVC. Bal Inclusief.

📏 20 x 16 cm 📦 100 / 50 🗑️ Print Code: E(1)



Barón 9670

Aircraft. EVA. Board: 17 x 13,5 x 0,3 cm. Aircraft: 12,7 x 4 x 15 cm.
Sportflugzeug. EVA. Puzzelbrett: 17 x 13,5 x 0,3 cm. Flugzeug: 12,7 x 4 x 15 cm.
Avion. EVA. Plaque: 17 x 13,5 x 0,3 cm. Avion: 12,7 x 4 x 15 cm.
Vliegtuig. EVA. Board: 17 x 13,5 x 0,3 cm. Vliegtuig: 12,7 x 4 x 15 cm.

🗑️ Consult. 📦 720 / 20 🗑️ Print Code: E(1)



Cissex 20398

Game. Wheat Straw/ ABS. 42 Pieces.
Spiel. Weizenstroh/ ABS. 42 Stück.
Jeu. Paille de Blé/ ABS. 42 Pièces.
Spel. Tarwestro/ ABS. 42 Stuks.

📏 18 x 12,5 x 2,8 cm 📦 50 / 100 🗑️ Print Code: D(1), W



Carlo 8850

Skill Games. 24 Assorted Games.
Geschicklichkeitsspiele. 24 Spiele Sortiert.
Jeux d' "Habiletés". 24 Jeux Assortis.
Behendigheidsspel. 24 Verzamelde Spelen.

📏 4 x 4 x 4 cm 📦 576 / 24 🗑️ Print Code: C(4)



Diamond 3392

Game. Magnetic.
Spiel. Magnetisch.
Jeu. Magnétique.
Spel. Magnetisch.

📏 13 x 1 x 13 cm 📦 200 / 50 🗑️ Print Code: D(1)

Summer
time



03



05

19

01

Spike 7003

Kids Sunglasses. UV400 Protection.
Kindersonnenbrille. UV400 Schutz.
Lunettes de Soleil Enfant. Protection UV400.
Kinder Zonnebril. UV400 Bescherming.

Consult. 400 / 10 Print Code: D(4)



05



21

03

01

Koldy 6151

Duck. PVC.
Ente. PVC.
Canard. PVC.
Eend. PVC.

8.4 x 7.7 x 7 cm 100 / 50 Print Code: D(1)



Dayane 1726

Fan. 2 Modes. 3 Batteries AAA Not Included.
Ventilator. 2 Positionen. 3 AAA Batterien Nicht im Lieferumfang.
Ventilateur. 2 Modes. 3 Piles AAA Non Incluses.
Ventilator. 2 Posities. 3 Batterijen AAA Niet Inclusief.

8 x 17.5 x 2.5 cm 100 / 50 Print Code: D(4)



05

19

03

04

Bujass 4686

Bubbles. Liquid Not Included.
Seifenblasen. Flüssigkeit Nicht im Lieferumfang.
Jeu Bulles Savon. Liquide Non Incluse.
Belleblaas. Vloeistof Niet Inclusief.

Ø 3.7 x 11.2 cm 500 / 50 Print Code: C(4)



11



03

19

05

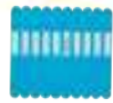
WATER
RESISTANT

IDEAL FOR PRINTING
10PCS

Mawi 3842

Bracelet. Tyvek® Material. One Size. Kids. Safety Catch.
Armband. Tyvek® Material. Einheitsgröße. Kinder. Sicherheitsverschluss.
Bracelet. Tyvek® Material. Taille Unique. Enfant. Fermeture Sécurité.
Armband. Tyvek® Material. Eén Maat. Kind. Veiligheidsluiting.

23 x 2.5 cm 20000 / 1000 Print Code: A(1)



Tecnar 4730

Notebook. Recycled Cardboard. Hard Cover. 80 Sheets. Recycled Cardboard Pen Included.

Notizbuch. Recycling Pappe. Hardcover-Abdeckung. 80 Blätter. Recycling Pappe Kugelschreiber Inklusiv.

Cahier. Carton Recyclé. Couverture Rigide. 80 Feuilles. Stylo Carton Recyclé Inclusive.

Notitieboek. Gerecycled Karton. Harde Kaft. 80 Blaadjes. Pen Gerecycled Karton Inclusief.

23.7 x 29 x 2 cm 20 Print Code: E(4), B(4)

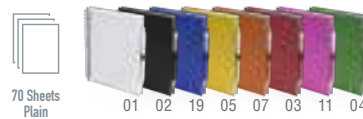

Koguel 4729

Notebook. Recycled Cardboard. Hard Cover. 70 Sheets. Recycled Cardboard Pen Included.

Notizbuch. Recycling Pappe. Hardcover-Abdeckung. 70 Blätter. Recycling Pappe Kugelschreiber Inklusiv.

Cahier. Carton Recyclé. Couverture Rigide. 70 Feuilles. Stylo Carton Recyclé Inclusive.

Notitieboek. Gerecycled Karton. Harde Kaft. 70 Blaadjes. Pen Gerecycled Karton Inclusief.

15 x 18.2 x 1.9 cm 50 / 25 Print Code: E(4), B(4)



Pilaf 4670

Notebook. Recycled Cardboard. Hard Cover. 50 Sheets. Recycled Cardboard Pen Included.

Notizbuch. Recycling Pappe. Hardcover-Abdeckung. 50 Blätter. Recycling Pappe Kugelschreiber Inklusiv.

Cahier. Carton Recyclé. Couverture Rigide. 50 Feuilles. Stylo Carton Recyclé Inclusive.

Notitieboek. Gerecycled Karton. Harde Kaft. 50 Blaadjes. Pen Gerecycled Karton Inclusief.

8.6 x 11.7 x 1.3 cm 200 / 50 Print Code: E(4), B(4)

Recycled

CARDBOARD



80 Sheets
Plain



New

Hantiz 20167

Notebook. Recycled Cardboard. Hard Cover. 80 Sheets.
Notizbuch. Recycling Pappe. Hardcover-Abdeckung. 80 Blätter.
Cahier. Carton Recyclé. Couverture Rigide. 80 Feuilles.
Notitieboek. Gerecycled Karton. Harde Kaft. 80 Blaadjes.

16.4 x 21.7 x 1.6 cm 50 / 25 Print Code: E(4)



New



Kanlio 20165

Notebook. Recycled Cardboard. 60 Sheets.
Notizbuch. Recycling Pappe. 60 Blätter.
Cahier. Carton Recyclé. 60 Feuilles.
Notitieboek. Gerecycled Karton. 60 Blaadjes.

14.4 x 21 x 0.8 cm 100 / 10 Print Code: E(4)



60 Sheets
Plain

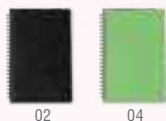

02

04



19

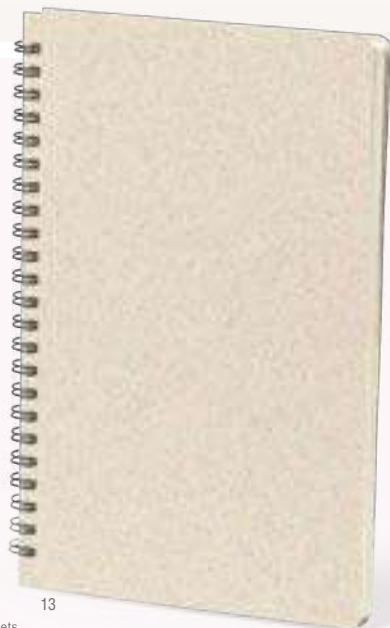

13

Roshan 1407

Notebook. Wheat Straw/ PP. 80 Sheets.
Notizbuch. Weizenstroh/ PP. 80 Blätter.
Cahier. Paille de Blé/ PP. 80 Feuilles.
Notitieboek. Tarwestro/ PP. 80 Blaadjes.

14.5 x 21 x 1.5 cm 50 / 25 Print Code: E(4)



New



19

02

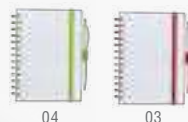

04

03



01

Ciara 20220

Notebook. Recycled ABS. Hard Cover. 70 Sheets. RABS Pen Included.
Notizbuch. Recycling ABS. Hardcover-Abdeckung. 70 Blätter. RABS Kugelschreiber Inklusiv.
Cahier. ABS Recyclé. Couverture Rigide. 70 Feuilles. Stylo RABS Inclusive.
Notitieboek. Gerecycled ABS. Harde Kaft. 70 Blaadjes. Pen RABS Inklusief.

14 x 18 x 1.5 cm 50 / 25 Print Code: E(4), B(4)



70 Sheets
Lined





Godiva 8587



Pencil. Wood.
Bleistift. Holz.
Crayon. Bois.
Potlood. Hout.



+10.000 uds
PRINTING 12% Dto.

NEW
COLOR

17

Ø 0.7 × 18.6 cm 2000 / 100
Print Code: A(4), L1



Togi 4173



Pencil. Wood.
Bleistift. Holz.
Crayon. Bois.
Potlood. Hout.

Ø 0.7 × 19 cm 2000 / 100 Print Code: A(4), L1



04

Flexi 3095



Pencil. PVC. Flexible.
Bleistift. PVC. Flexibel.
Crayon. PVC. Flexible.
Potlood. PVC. Flexibel.

Ø 0.6 × 32 cm 1000 / 100 Print Code: B(1)



01

02

03

05

07

11

19



19

Gabon 5647



Set. Recycled Cardboard. 5 Pieces.
Set. Recycling Pappe. 5 Stück.
Set. Carton Recyclé. 5 Pièces.
Set. Gerecycled Karton. 5 Stuks.

4.5 × 17.7 × 1.5 cm 400 / 50 Print Code: B(4), W



03

04

05



01 02 03 05 07 19

New



04

Baxter 20374

Eternal Pencil. Recycled ABS.
Ewiger Bleistift. Recycling ABS.
Crayon Éternel. ABS Recyclé.
Bleistift. Gerecycled ABS.

Ø 0.8 x 15.3 cm 1000 / 100 Print Code: A(4)



01 02 03 04 05 07

New



19

Astril 20375

Eternal Pencil.
Ewiger Bleistift.
Crayon Éternel.
Bleistift.

Ø 0.9 x 14.4 cm 2000 / 100 Print Code: A(4)



New

Seryi 20146

Eternal Pencil. Bamboo. File Included.
Ewiger Bleistift. Bambus. Felle Inklusive.
Crayon Éternel. Bambou. Lime Incluse.
Bleistift. Bamboe. Vjfl Inclusief.

Ø 0.8 x 15 cm 200 / 50
Print Code: C(4), L1



Billy 20145

Eternal Pencil. Bamboo.
Ewiger Bleistift. Bambus.
Crayon Éternel. Bambou.
Bleistift. Bamboe.

Ø 0.8 x 15.4 cm 1000 / 50
Print Code: A(4), L1



Yeidy 1288

Eternal Pencil. Recycled Cardboard/ Wheat Straw/ ABS.
Ewiger Bleistift. Recycling Papper/ Weizenstroh/ ABS.
Crayon Éternel. Carton Recyclé/ Paille de Blé/ ABS.
Bleistift. Gerecycled Karton/ Tarwestro/ ABS.

Ø 0.8 x 13.9 cm 1000 / 50
Print Code: A(4), W



03 02 01



19

Ludrick 20150 ERASABLE INK

Erasable Pen. Jumbo Refill.
Radierbarer Kugelschreiber. Jumbo Mine.
Stylo Effaçable. Recharge Jumbo.
Uitwisbare Pen. Jumbo Refill.

Ø 1.2 x 14.5 cm 1000 / 50 Print Code: A(4)



04 05 07 02 19

Gradox 5735

Pen.
Kugelschreiber.
Stylo.
Pen.

Ø 2.3 x 17.5 cm 1000 / 50 Print Code: B(4)



03



04 05 07 11 19

Nicky 4707

Pen. Multicolour Led Lights. Button Batteries Included.
Kugelschreiber. Mehrfarbige Led Lichten. Knopfzellen Inklusive.
Stylo. Lumières Led Multicolores. Piles Bouton Incluses.
Pen. Meerkleurige Led Lichten. Knopcel Batterijen Inclusief.

Ø 2.8 x 18.5 cm 500 / 50 Print Code: B(1)



03



FUNNY
writing



03

Krujer 5035

Pen Torch. 1 Led. Button Batteries Included.
Kugelschreiber Lampe. 1 Led. Knopfzellen Inklusive.
Stylo Lampe. 1 Led. Piles Bouton Incluses.
Pen-Zaklamp. 1 Led. Knopcel Batterijen Inclusief.

Ø 1 x 11 cm 500 / 50 Print Code: C(4)



09 02 19



Longi 3425

Sharpener.
Anspitzer.
Taille-Crayons.
Potlood Slipjer.

3.7 x 6 x 4.2 cm 600 / 50 Print Code: C(1)



Lektura 3585

Lamp. 1 Led. Flexible. Button Batteries Included.
Lampe. 1 Led. Flexibel. Knopfzellen Inklusiv.
Lampe. 1 Led. Flexible. Piles Bouton Incluses.
Lamp. 1 Led. Flexibel. Knooppel Batterijen Inclusief.

3 x 25 x 2 cm 200 / 50 Print Code: E(1)



Cafey 3337

Set. Eraser and Sharpener.
Set. Radiergummi und Anspitzer.
Set. Gomme et Taille-Crayon.
Set. Gum en Potlood Slipjer.

6 x 2.1 x 3 cm 600 / 20 Print Code: B(4)



Winlon 5403

Notebook. Hard Cover. 40 Sheets.
Notizbuch. Hardcover-Abdeckung. 40 Blätter.
Cahier. Couverture Rigide. 40 Feuilles.
Nottieboek. Harde Kaft. 40 Blaadjes.

8 x 9 x 1.1 cm 500 / 50 Print Code: D(4)



Elysium 20377

Set. Wheat Straw/ ABS. Eraser and Sharpener.
Set. Weizenstroh/ ABS. Radiergummi und Anspitzer.
Set. Paille de Blé/ ABS. Gomme et Taille-Crayon.
Set. Tarwestro/ ABS. Gum en Potlood Slipjer.

4 x 6 x 1.9 cm 400 / 50 Print Code: B(1)



Dilaver 20376

Sharpener. Bamboo/ Wheat Straw/ ABS.
Anspitzer. Bambus/ Weizenstroh/ ABS.
Taille-Crayon. Bambou/ Paille de Blé/ ABS.
Potlood Slipjer. Bamboe/ Tarwestro/ ABS.



4.4 x 6.3 cm 400 / 50
Print Code: B(4), L1



RULER

Flexor 3055

Ruler: 30 cm. Flexible.
Lineal: 30 cm. Flexibel.
Règle: 30 cm. Flexible.
Liniaal: 30 cm. Flexibel.

 31.5 x 3 x 0.3 cm  500 / 125
 Print Code: E(1)



Arnax 20378

Ruler: Wood: 30 cm.
Lineal: Holz: 30 cm.
Règle: Bois: 30 cm.
Liniaal: Hout: 30 cm.

 31 x 2.5 x 0.3 cm  500 / 100
 Print Code: D(1), L2, W



Nitria 6679

Antibacterial Ruler: 30 cm and 12".
Antibakterieel Lineal: 30 cm und 12".
Règle Antibacteriennene: 30 cm et 12".
Antibacterieel Liniaal: 30 cm en 12".

 31.5 x 4 x 0.2 cm  500 / 100
 Print Code: D(1), L, W





Marnik 5479

Whiteboard. 3 Chalks, Felt Tip Pen and Eraser Included.
Tafel. 3 Kreiden, Filzstift und Radierer Inklusief.
Ardoise. 3 Craies, Feutre et Effaceur Incluses.
Whiteboard. 3 Krijtjes, Felt Tip Pen en Gum Inclusief.

31 x 21 x 1.2 cm 50 Print Code: E(1), L2



TWO SIDES



Blerim 20388

Whiteboard. Chalk Included.
Tafel. Kreide Inklusief.
Ardoise. Craie Inklusief.
Whiteboard. Krijtje Inklusief.

12 x 23 x 2.5 cm 50 Print Code: D(1), L1



01



02

Koptul 6247

LCD Writing Tablet. Magnetic. Pen and Button Battery Included.
LCD-Schreibtablett. Magnetisch. Bleistift und Knopfzelle Inklusief.
Tablette d'écriture LCD. Magnétique. Crayon et Pile Bouton Inklusief.
LCD Tablet om te Schrijven. Magnetisch. Potlood en Knopcel Batterij Inklusief.

14.7 x 22.5 x 0.5 cm 100 / 50 Print Code: E(1), W



Arraky 20384

LCD Writing Tablet. Pen and Button Battery Included.
LCD-Schreibtablett. Bleistift und Knopfzelle Inklusief.
Tablette d'écriture LCD. Crayon et Pile Bouton Inklusief.
LCD Tablet om te Schrijven. Potlood en Knopcel Batterij Inklusief.

8.7 x 11.6 x 0.5 cm 400 / 100 Print Code: D(4), W



03



05



02



19



13



04

Tage 9976

Pencil Case, Polyester 600D.
 Federmappe, Polyester 600D.
 Trousse, Polyester 600D.
 Etui, Polyester 600D.

22 x 11.5 cm 500 / 10 Print Code: F(1), N(8), O



19

05



11

07

04

03

02

Celes 3987

Pencil Case, Polyester 600D.
 Federmappe, Polyester 600D.
 Trousse, Polyester 600D.
 Etui, Polyester 600D.

Ø 6.5 x 22.5 cm 250 / 10 Print Code: F(1), N(8), O



13

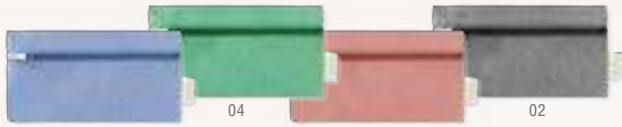

19

04

03

02

Laybax 1668

Pencil Case, 100% Recycled Cotton.
 Federmappe, 100% Recycling Baumwolle.
 Trousse, 100% Coton Recyclé.
 Etui, 100% Gerecycled Katoen.

22 x 11.5 cm 300 / 50 Print Code: F(1), N(8), O

RECYCLED
COTTON



03

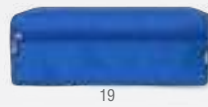

19



04



02

Yeimy 6986

Pencil Case, Polyester 600D RPET.
 Federmappe, Polyester 600D RPET.
 Trousse, Polyester 600D RPET.
 Etui, Polyester 600D RPET.

22 x 8 x 5 cm 300 / 50 Print Code: F(1), N(8), O

RPET

Recycled CARDBOARD



19



04



05



03

Rumbix 6092

Thermal Bag. Laminated Recycled Paper/ Aluminium.
Wärme Tasche. Laminiertes Recycling Papier/ Aluminium.
Sac Thermique. Papier Recyclé Laminé/ Aluminium.
Thermo-Tasje. Gelamineerd Gerecycled Papier/ Aluminium.

20 x 25 x 10 cm 100 / 50 Print Code: G(1)



Akiles 1720

Thermal Snacks Holder. Laminated Recycled Paper/ PEVA.
Wärme Lunch Box Tasche. Laminiertes Recycling Papier/ PEVA.
Lunch-Box Thermique. Papier Recyclé Laminé/ PEVA.
Thermo Boterhammentrommel. Gelamineerd Gerecycled Papier/ PEVA.

18 x 18 x 1 cm 500 / 50 Print Code: F(1)



Batuk 1719

Thermal Sandwich Holder. Laminated Recycled Paper/ Aluminium.
Wärme Lunch Box Tasche. Laminiertes Recycling Papier/ Aluminium.
Lunch-Box Thermique. Papier Recyclé Laminé/ Aluminium.
Thermo Boterhammentrommel. Gelamineerd Gerecycled Papier/ Aluminium.

21 x 8 x 7.5 cm 300 / 25 Print Code: E(1), N(8)



05



03



19

05

04



03

04

19

01



02

01

Noix 2500

450 ml

Sandwich Lunch Box. PP. 450 ml.
Sandwich Lunch Box. PP. 450 ml.
Gamelle Sandwich. PP. 450 ml.
Boterhammen-Lunchbox. PP. 450 ml.

13 x 5 x 13.5 cm 160 / 40 Print Code: E(1)

Rufus 4028

Thermal Sandwich Holder. PVC/ Aluminium.
Wärme Lunch Box Tasche. PVC/ Aluminium.
Lunch-Box Thermique. PVC/ Aluminium.
Thermo Boterhammentrommel. PVC/ Aluminium.

21 x 8 x 7.5 cm 300 / 25 Print Code: E(1), N(8)



19

Tradan 5235

Drawstring Cool Bag. Polyester 210D/ Aluminium.
Kühltasche Rucksack. Polyester 210D/ Aluminium.
Sac à Dos Glacière. Polyester 210D/ Aluminium.
Koeltas-Rugzak. Polyester 210D/ Aluminium.

27 x 33 cm 200 / 10 Print Code: G(1)

05

07

03

11

02

01

04

01

04



B

Llorel 5705

Drawstring Bag, Polyester 210T.
Rucksack, Polyester 210T.
Sac à Dos, Polyester 210T.
Rugzak, Polyester 210T.

26 x 30 cm 500 / 10 Print Code: F(1), N(8)



J



19

Kissa 4788

Foldable Drawstring Bag, Polyester 190T.
Faltbarer Rucksack, Polyester 190T.
Sac à Dos Pliable, Polyester 190T.
Opvouwbare Rugzak, Polyester 190T.

26.5 x 32.5 cm 500 / 10 Print Code: F(1), G(1)



05



07



01



03

Trokyn 6449

Drawstring Bag, Polyester 210D.
Rucksack, Polyester 210D.
Sac à Dos, Polyester 210D.
Rugzak, Polyester 210D.

31.5 x 42 cm 300 / 10
Print Code: F(1), N(8), R



01

05

19



02

07

04



D

Naiper 5889

Drawstring Bag, Polyester 210D.
Rucksack, Polyester 210D.
Sac à Dos, Polyester 210D.
Rugzak, Polyester 210D.

42 x 43 cm 300 / 20 Print Code: F(1), N(8)



C



G



07

Dinki 5091

Drawstring Bag. Polyester 210D.
Rucksack. Polyester 210D.
Sac à Dos. Polyester 210D.
Rugzak. Polyester 210D.

📏 27 x 32 cm 📦 500 / 50
🖨️ Print Code: F(1), N(8), R



New

Ashara 20393

03

Drawstring Bag. 100% Recycled Cotton.
Rucksack. 100% Recycling Baumwolle.
Sac à Dos. 100% Coton Recyclé.
Rugzak. 100% Gerecycled Katoen.

📏 27 x 32 cm 📦 150 / 50 🖨️ Print Code: F(6), N(8), O, P



Susdal 6424

03

Backpack. Polyester 600D. Padded Back and Shoulder Straps.
Rucksack. Polyester 600D. Gepolsterter Rücken und Schultergurte.
Sac à Dos. Polyester 600D. Dos et Bretelles Rembourrées.
Rugzak. Polyester 600D. Gewatteerde Achterzijde en Schouderbanden.

📏 25 x 30 x 12 cm 📦 50 🖨️ Print Code: G(1), N(8), O, P



Maggie 6987

04

Backpack. Polyester 600D RPET. Padded Back and Shoulder Straps.
Rucksack. Polyester 600D RPET. Gepolsterter Rücken und Schultergurte.
Sac à Dos. Polyester 600D RPET. Dos et Bretelles Rembourrées.
Rugzak. Polyester 600D RPET. Gewatteerde Achterzijde en Schouderbanden.

📏 25 x 30 x 12 cm 📦 50 🖨️ Print Code: G(1), N(8), O



19 03 02

kids BOTTLE



03



16

07

19

01

Dokmo 20389

Bottle, RPET/ Stainless Steel, 350 ml.
Trinkflasche, RPET/ Rostfreier Stahl, 350 ml.
Bidon, RPET/ Acier Inox, 350 ml.
Fles, RPET/ Roestvrij Staal, 350 ml.

📏 Ø 6.5 × 16.3 cm 📦 50 🗑️ Print Code: F(1), L1



19



05

03

Deldye 5560

Bottle, Tritan, 440 ml.
Trinkflasche, Tritan, 440 ml.
Bidon, Tritan, 440 ml.
Fles, Tritan, 440 ml.

📏 Ø 7 × 16 cm 📦 50 🗑️ Print Code: F(1)



21



03

07

05

19

11

01

Zanip 4596

Bottle, PS, 600 ml.
Trinkflasche, PS, 600 ml.
Bidon, PS, 600 ml.
Fles, PS, 600 ml.

📏 Ø 7.2 × 22.5 cm 📦 100 / 20 🗑️ Print Code: F(1)

RPET 

19



Rick 1534

Kids Cap. Polyester RPET. 5 Panels. Velcro Closure.
 Kinder Mütze. Polyester RPET. 5 Panels. Klettverschluss.
 Casquette Enfant. Polyester RPET. 5 Panneaux. Fermeture Velcro.
 Kinder Pet. Polyester RPET. 5 Panelen. Klittenband Stuiting.

 Consult.  300 / 30  Print Code: F(1), N(8), O, P, R

New



ORGANIC COTTON 



Lemkin 20507

Kids Cap. 100% Organic Cotton. 6 Panels. Buckle Closure.
 Kinder Mütze. 100% Organische Baumwolle. 6 Panels. Schnallen Verschluss.
 Casquette Enfant. 100% Organic Cotton. 6 Panneaux. Fermeture à Boucle.
 Kinder Pet. 100% Organisch Katoen. 6 Panelen. Gesp Stuiting.

 Consult.  200 / 50  Print Code: F(1), N(8), O, P, R

New



ORGANIC COTTON 



Avot 20506

Kids Cap. 100% Organic Cotton. 5 Panels. Velcro Closure.
 Kinder Mütze. 100% Organische Baumwolle. 5 Panels. Klett Verschluss.
 Casquette Enfant. 100% Organic Cotton. 5 Panneaux. Fermeture Velcro.
 Kinder Pet. 100% Organisch Katoen. 5 Panelen. Klittenband Stuiting.

 Consult.  200 / 50  Print Code: F(1), N(8), O, P, R



05

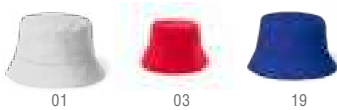

Timón 3342

Kids Hat. 100% Cotton.
 Kinder Hut. 100% Baumwolle.
 Bonnet Enfant. 100% Coton.
 Kinder Muts. 100% Katoen.

 Consult.  200 / 50  Print Code: F(1), N(8), O, P, R



19



Modiak 5239

Kids Cap. Microfibre/ Polyester. 5 Panels. Velcro Closure.
 Kinder Mütze. Mikrofaser/ Polyester. 5 Panels. Klettverschluss.
 Casquette Enfant. Microfibre/ Polyester. 5 Panneaux. Fermeture Velcro.
 Kinder Pet. Microfibre/ Polyester. 5 Panelen. Klittenband Stuiting.

 Consult.  300 / 50  Print Code: F(1), N(8), O, P, R



01



Sportkid 3329

Kids Cap. 100% Cotton. 5 Panels. Velcro Closure.
 Kinder Mütze. 100% Baumwolle. 5 Panels. Klettverschluss.
 Casquette Enfant. 100% Coton. 5 Panneaux. Fermeture Velcro.
 Kinder Pet. 100% Katoen. 5 Panelen. Klittenband Stuiting.

 Consult.  300 / 30  Print Code: F(1), N(8), O, P, R



Lowchen 20391

Set. Toothbrush Bamboo. Sand Timer Wheat Straw/ ABS, 2 Minutes. Cotton Pouch.
 Set. Zahnbürste Bambus. Sanduhr Weizenstroh/ ABS, 2 Minuten. Baumwolle Etui.
 Set. Brosse à Dents Bambou. Sablier Paille de Blé/ ABS, 2 Minutes. Étui Coton.
 Set. Tandemborstel Bamboe. Zandloper Tarwestro/ ABS, 2 Minuten. Katoen Zakje.

20 x 7.5 x 1.7 cm 200 / 50 Print Code: C(4), F(1), L1, N(8)



Becu 20392

Toothbrush. Bamboe.
 Zahnbürste. Bambus.
 Brosse à Dents. Bamboe.
 Tandemborstel. Bamboe.

1.3 x 14.5 x 1.7 cm 500 / 50 Print Code: C(4), L1



Siapax 5275

Sand Timer. 2 Minutes.
 Sanduhr. 2 Minuten.
 Sablier. 2 Minutes.
 Zandloper. 2 Minuten.

1.8 x 6 x 2.5 cm 1000 / 100 Print Code: C(4)



Fident 5032

Set. Toothbrush and Sand Timer. 2 Minutes.
 Set. Zahnbürste und Sanduhr. 2 Minuten.
 Set. Brosse à Dents et Sablier. 2 Minutes.
 Set. Tandemborstel en Zandloper. 2 Minuten.

8 x 20 x 2 cm 200 / 10 Print Code: F(1), L1

Cooking time



03



Marduk 1514

Kitchen Set. PP/ Silicone/ Cotton. 3 Pieces. Non-Woven Pouch.
Küchen Set. PP/ Silikon/ Baumwolle. 3 Stück. Non-Woven Etui.
Set Cuisine. PP/ Silicone/ Coton. 3 Pièces. Étui T.N.T..
Keuken Set. PP/ Siliconen/ Katoen. 3 Stuks. Non-Woven Zakje.

20 x 20 cm 100 / 50 Print Code: F(1), B(1),



Legox 4754

Set. Non-Woven. 2 Pieces. One Size. Kids.
Set. Non-Woven. 2 Stück. Einheitsgröße. Kinder.
Set. T.N.T.. 2 Pièces. Taille Unique. Enfant.
Set. Non-Woven. 2 Stuks. Eén Maat. Kind.

Consult. 200 / 50 Print Code: G(1)



01

19



Seter 20367

Umbrella. Polyester 190T. Metal Ribs. 18". Automatic. Polyester Pouch.
Regenschirm. Polyester 190T. Metall Rippen. 18". Automatisch. Polyester Etui.
Parapluie. Polyester 190T. Tiges Métal. 18". Automatique. Étui Polyester.
Paraplu. Polyester 190T. Ribben Metaal. 18". Automatisch. Polyester Zakje.

☒ Ø 78 cm ☑ 50 ☎ Print Code: G(1), N(8)

New



Claytop 20346

Raincoat. PE. One Size. Kids. 90 x 64 cm. Polyester RPET Pouch.
Poncho. PE. Einheitsgröße. Kinder. 90 x 64 cm. Polyester RPET Etui.
Poncho. PE. Taille Unique. Enfant. 90 x 64 cm. Étui Polyester RPET.
Kinder-Regenjas. PE. Eén Maat. Kind. 90 x 64 cm. Polyester RPET Zakje.

☒ 8.5 x 10 x 2 cm ☑ 200 / 25 ☎ Print Code: E(1)



Teo 3221

Raincoat. PVC. One Size. Kids. 90 x 64 cm. PVC Pouch.
Poncho. PVC. Einheitsgröße. Kinder. 90 x 64 cm. PVC Etui.
Poncho. PVC. Taille Unique. Enfant. 90 x 64 cm. Étui PVC.
Kinder-Regenjas. PVC. Eén Maat. Kind. 90 x 64 cm. PVC Zakje.

☒ 18 x 15 cm ☑ 100 / 25 ☎ Print Code: G(1), H(1)



19



19

Holiam 5506

Neck Warmer. Polyester.
Nacken Wärmer. Polyester.
Tour de Cou. Polyester.
Colsjaal. Polyester.

☒ 21 x 40 cm ☑ 500 / 100 ☎ Print Code: G(1), N(8), R



21

03

04

19

22

05

Anut 3721

Scarf. Polar Fleece 180 g/ m2.
Schal. Polar Fleece 180 g/ m2.
Écharpe. Polaire 180 g/ m2.
Sjaal. Polar Fleece 180 g/ m2.

☒ 91 x 12 cm ☑ 400 / 10 ☎ Print Code: N(8), O, P



19

03

05

Siku 3720

Mitten. Polar Fleece 180 g/ m2. One Size. Kids.
Handschuh. Polar Fleece 180 g/ m2. Einheitsgröße. Kinder.
Gant. Polaire 180 g/ m2. Taille Unique. Enfant.
Wanten. Polar Fleece 180 g/ m2. Eén Maat. Kind.

☒ 8 x 11 cm ☑ 400 / 10 ☎ Print Code: N(8), O



03

19

04

05

Pigun 5132

Touchscreen Gloves. Acrylic. One Size. Kids.
Touchpad Handschuhe. Acryl. Einheitsgröße. Kinder.
Gant Tactile. Acrylique. Taille Unique. Enfant.
Touchscreen Handschoenen. Acryl. Eén Maat. Kind.

☒ Consult. ☑ 500 / 10 ☎ Print Code: N(8)



Elektra 20382

Security Light. 3 Leds. 3 Light Modes, Fixed and Flashing. Button Batteries Included.

Sicherheitslicht. 3 Leds. 3 Lichtpositionen, Festes und Blinkendes. Knopfzellen Inklusive.

Lumière de Sécurité. 3 Leds. 3 Modes de Lumière, Fixe et Clignotante. Piles Bouton Incluses.

Veiligheidslicht. 3 Leds. 3 Licht Posities, Vast en Knipperend. Knoopcel Batterijen Inclusief.

5.5 x 7.6 x 0.7 cm 200 / 50 Print Code: C(1)



Koreflec 5659

Keyring. PVC. Reflective.

Schlüsselanhänger. PVC. Reflektierend.

Porte-Clés. PVC. Réfléchissant.

Sleutelhanger. PVC. Reflectorend.

6.1 x 5.3 x 0.2 cm 1000 / 100 Print Code: C(4)



Pincher 20381

Whistle. 6 COB Lights. 3 Light Modes, Fixed and Flashing. Button Batteries Included.

Pfeife. 6 COB Lichter. 3 Lichtpositionen, Festes und Blinkendes. Knopfzellen Inklusive.

Siffllet. 6 Lumières COB. 3 Modes de Lumière, Fixe et Clignotante. Piles Bouton Incluses.

Fluitje. 6 COB Lichten. 3 Licht Posities, Vast en Knipperend. Knoopcel Batterijen Inclusief.

7.6 x 3.5 x 1.8 cm 500 / 100 Print Code: C(1)



09



05

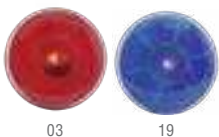

03

19

Flash 3025

Security Light. 1 Flashing Led. Button Batteries Included.

Sicherheitslicht. 1 Led Blinkende. Knopfzellen Inklusive.

Lumière de Sécurité. 1 Led Clignotante. Piles Bouton Incluses.

Veiligheidslicht. 1 Knipperend Led. Knoopcel Batterijen Inclusief.

Ø 4.9 x 1.5 cm 500 / 50 Print Code: C(1)



02

05F



Reflective 9550

Bracelet. PVC. Reflective.

Armband. PVC. Reflektierend.

Bracelet. PVC. Réfléchissant.

Armband. PVC. Reflectorend.

23 x 2.9 cm 1000 / 50 Print Code: D(1)



05

Eli 3264

Vest. Polyester. One Size. Kids.

Weste. Polyester. Einheitsgröße. Kinder.

Chasuble. Polyester. Taille Unique. Enfant.

Vest. Polyester. Eén Maat. Kind.

39 x 46 cm 100 / 20 Print Code: G(1)



03



19

20 BEST FRIENDS







New

Duval 20320

Pets Game. MDF/ Polyester.
 Spielzeug für Haustiere. MDF/ Polyester.
 Jeu d'Animaux de Compagnie. MDF/ Polyester.
 Spel voor Dieren. MDF/ Polyester.

📏 26.5 x 36 cm 📦 10 🖨️ Print Code: (1)



New

Kesel 20318

Pets Game. Wood.
 Spielzeug für Haustiere. Holz.
 Jeu d'Animaux de Compagnie. Bois.
 Spel voor Dieren. Hout.

📏 21 x 11 x 18.7 cm 📦 10 🖨️ Print Code: F(1), L2



New

Diny 20319

Pets Chair. Wood/ Canvas. Foldable.
 Haustier Stuhl. Holz/ Canvas. Faltbar.
 Chaise d'Animaux de Compagnie. Bois/ Toile. Pliable.
 Stoel voor Dieren. Hout/ Canvas. Opvouwbaar.

📏 47 x 38.5 x 37 cm 📦 10 🖨️ Print Code: H(1)

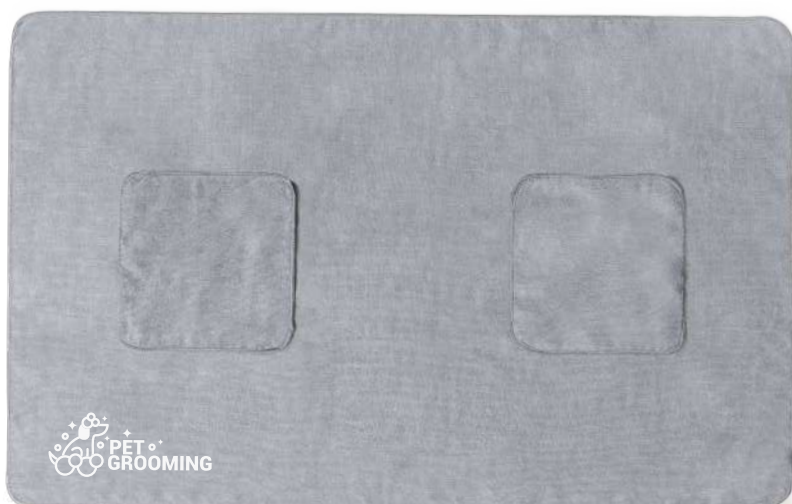

Yelyn 1504

66 x 106 cm

Pet Towel. Polyester 160 g/ m2. Polyester Pouch.
Haustier Handtuch. Polyester 160 g/ m2. Polyester Etui.
Serviette Animaux de Compagnie. Polyester 160 g/ m2. Étui Polyester.
Handdoek voor Dieren. Polyester 160 g/ m2. Polyester Zakje.

66 x 106 cm 50 Print Code: G(1), N(8), P



New



Vandyt 20317

Pets Brush. Wheat Straw/ ABS.
Haustier Bürste. Weizenstroh/ ABS.
Brosse d'Animaux de Compagnie. Paille de Blé/ ABS.
Dieren Haarborstel. Tarwestro/ ABS.

8,7 x 5 x 0,5 cm 500 / 100
Print Code: C(4)



Brolin 1501

Pet Brush. Wood.
Haustier Bürste. Holz.
Brosse Animaux de Compagnie. Bois.
Dieren Haarborstel. Hout.

6 x 23 x 7 cm 100 / 50 Print Code: D(1), L1



New



Akitax 20316

Pets Glove. Polyester/ TPR. One Size. Adult.
Haustier Handschuhe. Polyester/ TPR. Einheitsgröße. Erwachsene.
Gant d'Animaux de Compagnie. Polyester/ TPR. Taille Unique. Adulte.
Handschoenen voor Dieren. Polyester/ TPR. Eén Maat. Volwassenen.

Consult. 200 / 50 Print Code: N(8)



Tremony 20322

Bowl. Bamboe Fibre/ ABS.
Schüssel. Bambusfaser/ ABS.
Bol. Fibre Bambou/ ABS.
Voerbak. Bamboe Fibre/ ABS.

30 x 5.5 x 16.7 cm 40 Print Code: F(1)



Keken 1503

Foldable Bowl. Polyester RPET. 2 Compartments.
Faltbare Schüssel. Polyester RPET. 2 Abteilungen.
Bol Pliabile. Polyester RPET. 2 Compartiments.
Opvouwbare Voerbak. Polyester RPET. 2 Compartimenten.

28 x 14 x 9 cm 100 / 50 Print Code: N(8)

IDEAL FOR TAKE AWAY
- SUITABLE FOR LIQUID
AND FOOD

RPET



Poppy 1012

Foldable Bowl. Laminated Recycled Paper/ Polyester RPET.
Faltbare Schüssel. Laminiertes Recycling Papier/ Polyester RPET.
Bol Pliabile. Papier Recyclé Laminé/ Polyester RPET.
Opvouwbare Voerbak. Gelamineerd Gerecycled Papier/ Polyester RPET.

17 x 10 cm 200 / 10 Print Code: F(1)



IDEAL FOR TAKE AWAY
- SUITABLE FOR LIQUID
AND FOOD

RECYCLED PAPER



Saluki 20321

Foldable Bowl. Wheat Straw/ ABS/ TPR.
 Faltbare Schüssel. Weizenstroh/ ABS/ TPR.
 Bol Pliable. Paille de Blé/ ABS/ TPR.
 Opvouwbare Voerbak. Tarwestro/ ABS/ TPR.

32 x 5.3 x 12.9 cm 100 / 50 Print Code: E(1), L2



IDEAL FOR TAKE AWAY.
 SUITABLE FOR LIQUID
 AND FOOD



New

Pudle 20323

Feeding Pillow. Silicone.
 Futterkissen. Silikon.
 Coussin d'Alimentation. Silicone.
 Voedingskussen. Siliconen.

14.5 x 0.7 cm 100 / 50 Print Code: F(1)



IDEAL FOR TAKE AWAY.
 SUITABLE FOR LIQUID
 AND FOOD



IDEAL FOR TAKE AWAY
 - SUITABLE FOR LIQUID
 AND FOOD

Matsen 6171

Pets Set. Bottle PP. 2 Compartments 450 ml. Foldable Bowl TPR.
 Haustier Set. Trinkflasche PP. 2 Abteilungen 450 ml. Faltbare Schüssel TPR.
 Set Animaux de Compagnie. Bidon PP. 2 Compartiments 450 ml. Bol Pliable TPR.
 Dieren Set. Fles PP. 2 Compartimenten 450 ml. Opvouwbare Voerbak TPR.

11.3 x 23 cm 20 Print Code: E(1), L2



Baloyn 5935

Foldable Bowl. TPR.
 Faltbare Schüssel. TPR.
 Bol Pliable. TPR.
 Opvouwbare Voerbak. TPR.

12.9 x 5.2 cm 200 / 50
 Print Code: L2



250 ml

Eritsen 20326

Pets Bottle, PP, 250 ml.
 Trinkflasche für Haustier, PP, 250 ml.
 Bidon d'Animaux de Compagnie, PP, 250 ml.
 Fles voor Dieren, PP, 250 ml.

5 x 24 x 5 cm 100 / 50
 Print Code: F(1)



New

**Flaganan 20325**

Pets Bottle, ABS/ PET, 350 ml.
 Trinkflasche für Haustier, ABS/ PET, 350 ml.
 Bidon d'Animaux de Compagnie, ABS/ PET, 350 ml.
 Fles voor Dieren, ABS/ PET, 350 ml.

Ø 7 x 22 cm 40 / 20 Print Code: F(4)



350 ml

New



610 ml

IDEAL FOR TAKE AWAY.
 SUITABLE FOR LIQUID
 AND FOOD

Treiver 20324

Pets Set, ABS, 2 Compartments 330 ml and 280 ml.
 Haustier Set, ABS, 2 Abteilungen 330 ml und 280 ml.
 Set Animaux de Compagnie, ABS, 2 Compartiments 330 ml et 280 ml.
 Dieren Set, ABS, 2 Compartimenten 330 ml en 280 ml.

Ø 8 x 20.3 cm 50 Print Code: E(1)





Wabik 6681

Antibacterial Waste Bag Dispenser. 15 Biodegradable Bags Included.
 Antibakteriell Müllbeutelspender. 15 Kompostierbarer Beutel Inklusive.
 Distributeur de Sacs Antibacterienne. 15 Sacs Biodégradable Incluses.
 Antibacterieel Zakjes Dispenser. 15 Biologisch Afbreekbare Tassen Inclusief.

📏 Ø 4 x 10 cm 📦 200/20 🖨️ Print Code: D(4)



WHEAT STRAW

Leiren 6378

Waste Bag Dispenser. Bamboo Fibre/ PP. 15 Biodegradable Bags Included.
 Müllbeutelspender. Bambusfaser/ PP. 15 Kompostierbarer Beutel Inklusive.
 Distributeur de Sacs. Fibre Bambou/ PP. 15 Sacs Biodégradable Inclusive.
 Zakjes Dispenser. Bamboe Fibre/ PP. 15 Biologisch Afbreekbare Tassen Inclusief.

📏 8,2 x 5,4 x 4,1 cm 📦 200/50 🖨️ Print Code: D(4)



Seperd 20327

Waste Bag Dispenser. Polyester RPET. 15 Biodegradable Bags Included.
 Müllbeutelspender. Polyester RPET. 15 Kompostierbarer Beutel Inklusive.
 Distributeur de Sacs. Polyester RPET. 15 Sacs Biodégradable Incluses.
 Zakjes Dispenser. Polyester RPET. 15 Biologisch Afbreekbare Tassen Inclusief.

📏 8,8 x 5,5 x 3,5 cm 📦 200/50 🖨️ Print Code: E(1)



300 ml



Taxlen 2556

Dispenser Bottle. PP. 300 ml.
 Spenderflasche. PP. 300 ml.
 Bouteille Doseur. PP. 300 ml.
 Dispenser Fles. PP. 300 ml.

📏 Ø 6,4 x 18,5 cm 📦 150 🖨️ Print Code: F(1)



Muller 4618

Waste Bag Dispenser. 1 Led. 15 Bags Included. Button Batteries Included.
 Müllbeutelspender. 1 Led. 15 Beutel Inklusive. Knopfzellen Inklusive.
 Distributeur de Sacs. 1 Led. 15 Sacs Inclus. Piles Bouton Incluses.
 Zakjes Dispenser. 1 Led. 15 Tassen Inclusief. Knoopcelbatterij Inclusief.

📏 Ø 4,1 x 10,4 cm 📦 200/50 🖨️ Print Code: D(4)



05



04

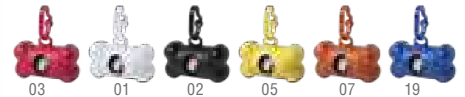

Rucin 5641

Waste Bag Dispenser. 15 Bags Included.
 Müllbeutelspender. 15 Beutel Inklusive.
 Distributeur de Sacs. 15 Sacs Incluses.
 Zakjes Dispenser. 15 Tassen Inclusief.

📏 8,2 x 5,4 x 4,1 cm 📦 200/50 🖨️ Print Code: D(4)



03

Mastif 20328

Pet Collar. Polyester. Adjustable.
Hundehalsband. Polyester. Verstellbar.
Collier. Polyester. Ajustable.
Halsband. Polyester. Aanpasbaar.

50 x 3.9 cm 200 / 100
Print Code: E(1), V



19

11

08

02



03



19



19

02



01



03

Muttley 3063

Pet Collar. Polyester. Reflective. Adjustable.
Hundehalsband. Polyester. Reflektierend. Verstellbar.
Collier. Polyester. Réfléchissant. Ajustable.
Halsband. Polyester. Reflectorend. Aanpasbaar.

50 x 1.8 cm 500 / 20 Print Code: E(1), V

Roco 3062

Bandana Pet Collar. Polyester. Adjustable.
Halstuch Hundehalsband. Polyester. Verstellbar.
Collier Bandana. Polyester. Ajustable.
Dieren Halsdoek-Halsband. Polyester. Aanpasbaar.

20 x 14 cm 400 / 20 Print Code: E(1), R

Bipols 5826

Bandana Pet Collar. Polyester. Reflective. Adjustable.
Halstuch Hundehalsband. Polyester. Reflektierend. Verstellbar.
Collier Bandana. Polyester. Réfléchissant. Ajustable.
Dieren Halsdoek-Halsband. Polyester. Reflectorend. Aanpasbaar.

23 x 15.5 cm 400 / 20 Print Code: E(1)



New

Bently 20333

Pet Lead. ABS/ Polyester. Extendable. With Brake.
Hundeleine. ABS/ Polyester. Ausziehbar. Mit Bremse.
Laisse pour Animaux. ABS/ Polyester. Extensible. Avec Frein.
Dierenriem. ABS/ Polyester. Verlengbaar. Met Rem.

16.5 x 10 x 3.5 cm 50 / 25
Print Code: E(1)



EXTENDABLE 3 METERS

BAGS NOT INCLUDED



New

Ivare 20330

Pet Lead. ABS/ Polyester.
Hundeleine. ABS/ Polyester.
Laisse pour Animaux. ABS/ Polyester.
Dierenriem. ABS/ Polyester.

14 x 14 x 2.9 cm 50 / 25
Print Code: E(1)



EXTENDABLE 3 METERS



141

287

280

Hoinzo 4979

Keyring Coin. Metal.
Schlüsselanhänger EK-Chip. Metall.
Porte-Clés Monnaie. Métal.
Munt-Stuethanger. Metaal.

Consult. 200 / 50
Print Code: D(1), L1



New

Kirix 20329

Pets Security Light. 1 Led. 3 Light Modes, Fixed and Flashing. Button Batteries Included.
Sicherheitslicht für Haustiere. 1 Led. 3 Lichtpositionen, Festes und Blinkendes. Knopfzellen Inklusiv.
Lumière de Sécurité d'Animaux de Compagnie. 1 Led. 3 Modes de Lumière, Fixe et Clignotante. Piles Bouton Incluses.
Veiligheidslicht voor Dieren. 1 Led. 3 Licht Posities, Vast en Knipperend. Knoopcel Batterijen Inclusief.

3 x 5.3 x 2 cm 400 / 50
Print Code: C(1)

New



03

Bigel 20315

Ball. TPR.
Ball. TPR.
Balle. TPR.
BaL. TPR.

📏 Ø 6.2 × 5.7 cm 📦 200 / 50 🖨️ Print Code: F(1)



08



19



SUBLIMATION



01

Flybit 3061

Frisbee. Cotton/ Polyester.
Frisbie. Baumwolle/ Polyester.
Frisbee. Coton/ Polyester.
Frisbie. Katoen/ Polyester.

📏 Ø 20 cm 📦 150 / 10 🖨️ Print Code: F(1), N(8), R



03



19

New



03



04



08



19

Girud 20332

Frisbee. TPR.
Frisbie. TPR.
Frisbee. TPR.
Frisbie. TPR.

📏 Ø 18.3 × 0.2 cm 📦 200 / 100 🖨️ Print Code: E(1)



07

Niki 9964

Ball.
Ball.
Balle.
BaL.

📏 Ø 6.4 cm 📦 200 / 20 🖨️ Print Code: L1, N(8)



03



19



Salmer 1502

Dog Chew Toy. Polyester/ TPR.
Kauknochen für Haustiere. Polyester/ TPR.
Jouet pour d'Animaux de Compagnie. Polyester/ TPR.
Speen voor Dieren. Polyester/ TPR.

📏 40 × 5.5 × 2 cm 📦 100 / 50 🖨️ Print Code: L1



New



Pecker 1115

Birdhouse. Wood.
Vogelhaus. Holz.
Maison d'Oiseau. Bois.
Vogelhuisje. Hout.

13 x 18 x 12.5 cm 40 Print Code: D(4), L1



Fenyx 20331

Birdhouse. Wood.
Vogelhaus. Holz.
Maison d'Oiseau. Bois.
Vogelhuisje. Hout.

8 x 22 x 8 cm 30 Print Code: D(4), L1



SUITABLE FOR LIQUID
AND FOOD

Xilam 1500

Bird Feeder. Bamboo Fibre/ Cotton.
Vogelfutterhaus. Bambusfaser/ Baumwolle.
Mangeoire d'Oiseau. Fibre Bambou/ Coton.
Vogelvoederhuisje. Bamboe Fibre/ Katoen.

Ø 15 x 60 cm 20 Print Code: F(1)

21 AUTO



CAR ACCESSORIES



New



Amiltox 20424

Holder. ABS/ Bamboo. Adjustable.
 Halter. ABS/ Bambus. Verstellbar.
 Support. ABS/ Bambou. Ajustable.
 Houder. ABS/ Bamboe. Aanpasbaar.

12.3 x 2.8 x 5.5 cm 200 / 100 Print Code: E(1), L1



Cultard 20425

Holder. ABS/ Bamboo. Adjustable.
 Halter. ABS/ Bambus. Verstellbar.
 Support. ABS/ Bambou. Ajustable.
 Houder. ABS/ Bamboe. Aanpasbaar.

9.5 x 9.5 x 5 cm 200 / 100 Print Code: E(1), L1



MAGNET

New



Toby 20255

Holder. Bamboo. Adhesive and Magnetic.
 Halter. Bambus. Haltend und Magnetisch.
 Support. Bambou. Adhésif et Magnétique.
 Houder. Bamboe. Klevend en Magnetisch.

4 x 5.7 x 3.2 cm 400 / 100 Print Code: E(4), L1

adjustable Holder

New



Vetel 20423

Holder. Adjustable.
Halter. Verstelbaar.
Support. Ajustable.
Houder. Aanpasbaar.

12 x 4.5 x 8 cm 100 / 25
 Print Code: E(1)



Lietor 6483

Holder. Adjustable.
Halter. Verstelbaar.
Support. Ajustable.
Houder. Aanpasbaar.

9.2 x 8.9 x 5.5 cm 100 / 50
 Print Code: E(1)



360° 45°

Gumbol 6785

Holder. Adjustable.
Halter. Verstelbaar.
Support. Ajustable.
Houder. Aanpasbaar.

7.7 x 3.2 x 7.4 cm 300 / 50 Print Code: E(1)



Daminus 5281

Holder. Adjustable.
Halter. Verstelbaar.
Support. Ajustable.
Houder. Aanpasbaar.

9.7 x 2.8 x 5 cm 300 / 50 Print Code: D(1), V



WIRELESS CHARGER

AUTO & ACCESSORIES



Odway 1440

Charger Holder. Wireless 10W. Adjustable.
Ladegerät Halter. Drahtlos 10W. Verstellbar.
Support Chargeur. Sans Fil 10W. Ajustable.
Oplader Houder. Draadloos 10W. Aanpasbaar.

9.2 x 10 x 10 cm 50 / 25 Print Code: E(1)



LIMITED
edition
EXPERIENCE



((15W))
WIRELESS
CHARGER



Yaben 1355

Charger Holder. Wheat Straw/ ABS/ Bamboo. Wireless 15W. Adjustable.
Ladegerät Halter. Weizenstroh/ ABS/ Bambus. Drahtlos 15W. Verstellbar.
Support Chargeur. Paille de Blé/ ABS/ Bambou. Sans Fil 15W. Ajustable.
Oplader Houder. Tarwestro/ ABS/ Bamboe. Draadloos 15W. Aanpasbaar.

11.2 x 11 x 7.5 cm 50 Print Code: E(1), F(1), L2

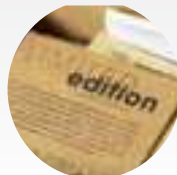

LIMITED
edition
EXPERIENCE



((15W))
WIRELESS
CHARGER



Yango 1354

Charger Holder. Wheat Straw/ ABS/ Bamboo. Wireless 15W. Adjustable.
Ladegerät Halter. Weizenstroh/ ABS/ Bambus. Drahtlos 15W. Verstellbar.
Support Chargeur. Paille de Blé/ ABS/ Bambou. Sans Fil 15W. Ajustable.
Oplader Houder. Tarwestro/ ABS/ Bamboe. Draadloos 15W. Aanpasbaar.

11.2 x 11 x 7.5 cm 50 Print Code: E(1), F(1), L2





New

Roketa 20422



Air Freshener. Bamboo/ Silicone. Lemon Aroma.
Lufterfrischer. Bambus/ Silikon. Zitronen Aroma.
Parfum Ambiance. Bambou/ Silicone. Arôme Citron.
Luchterfrisser. Bamboe/ Siliconen. Citroen Aroma.

📏 Ø 4.2 x 3.2 cm 📖 400 / 100 🖨️ Print Code: D(4), L1



05

03

Scrib 4276



Air Freshener. Lemon Aroma.
Lufterfrischer. Zitronen Aroma.
Parfum Ambiance. Arôme Citron.
Luchterfrisser. Citroen Aroma.

📏 Ø 5.2 x 3.8 cm 📖 400 / 50 🖨️ Print Code: D(4), V



01

19

02



09

02

Becrux 6292



Air Freshener. Aluminium/ ABS. Lemon Aroma.
Lufterfrischer. Aluminium/ ABS. Zitronen Aroma.
Parfum Ambiance. Aluminium/ ABS. Arôme Citron.
Luchterfrisser. Aluminium/ ABS. Citroen Aroma.

📏 5.7 x 4.2 x 3 cm 📖 400 / 50
🖨️ Print Code: D(4), L1



03



19

05

01

Telox 4250



Air Freshener. Glass. 5 mL. Ocean Aroma.
Lufterfrischer. Glas. 5 mL. Ozean Aroma.
Parfum Ambiance. Verre. 5 mL. Arôme Océan.
Luchterfrisser. Glas. 5 mL. Ozean Aroma.

📏 Ø 2.2 x 4.5 cm 📖 400 / 100 🖨️ Print Code: D(4)



200 ml

FOR CAR
& HOME

Trudy 6127

Humidifier. Multicolour Led Lights. 200 mL. 2 Steam Modes. USB Connection.
Luftbefeuchter. Mehrfarbige Led Lichten. 200 mL. 2 Dampf Funktionen. USB Anschluss.
Humidificateur. Lumières Led Multicolores. 200 mL. 2 Modes de Vapeur. Connexion USB.
Luchtbevochtiger. Meerkleurige Led Lichten. 200 mL. 2 Stoom Posities. USB Verbinding.

📏 Ø 6 x 14.9 cm 📖 50 🖨️ Print Code: E(1)



Abus 20421

TORCH, GLASS BREAKER
AND BELT CUTTER

Emergency Hammer. Aluminium. 6 COB Lights. Magnetic. 3 Functions. Button Batteries Included.
Nothammer. Aluminium. 6 COB Lichter. Magnetisch. 3 Funktionen. Knopfzellen Inklusiv.
Marteau de Secours. Aluminium. 6 Lumières. Magnétique. 3 Fonctions. Piles Bouton Incluses.
Nood Hamer. Aluminium. 6 COB Lichten. Magnetisch. 3 Functies. Knoopcel Batterijen Inclusief.

4.5 x 13 x 2.5 cm 100 / 50 Print Code: E(4)

TORCH, GLASS BREAKER
AND BELT CUTTER

01

02

Laguel 5815

Emergency Hammer. 1 Led. 4 COB Lights. 3 Light Modes. Fixed and Flashing. 3 Functions. Magnetic. Button Batteries Included.
Nothammer. 1 Led. 4 COB Lichter. 3 Lichtpositionen. Festes und Blinkendes. 3 Funktionen. Magnetisch. Knopfzellen Inklusiv.
Marteau de Secours. 1 Led. 4 Lumières COB. 3 Modes de Lumière. Fixe et Clignotante. 3 Fonctions. Magnétique. Piles Bouton Incluses.
Nood Hamer. 1 Led. 4 COB Lichten. 3 Licht Posities. Vast en Knipperend. 3 Functies. Magnetisch. Knoopcel Batterijen Inclusief.

2.7 x 12.3 x 1.5 cm 200 / 50 Print Code: E(4)

New

GLASS BREAKER AND
BELT CUTTER

Admir 20420

Keyring Emergency Hammer. 2 Functions.
Schlüsselanhänger Nothammer. 2 Funktionen.
Marteau de Secours Porte-Clés. 2 Fonctions.
Steutelhanger Nood Hamer. 2 Functies.

3.2 x 7.5 x 1.7 cm 400 / 50 Print Code: D(1)



Seleter 5437

Emergency Hammer. 1 Led. 3 Functions. Button Batteries Included.
Nothammer. 1 Led. 3 Funktionen. Knopfzellen Inklusiv.
Marteau de Secours. 1 Led. 3 Fonctions. Piles Bouton Incluses.
Nood Hamer. 1 Led. 3 Functies. Knoopcel Batterijen Inclusief.

7.6 x 13.3 x 2.4 cm 50 / 25 Print Code: E(4)



02

01

Hancar 6902

Emergency Light. 9 Flashing Leds. Magnetic. 3 Batteries AA Included.
 Nottlicht. 9 Blinkendes Leds. Magnetisch. 3 AA Batterien Inklusive.
 Lumière Urgence. 9 Leds Clignotantes. Magnétique. 3 Piles AA Incluses.
 Noodlicht. 9 Knipperend Leds. Magnetisch. 3 Batterijen AA Inclusief.

Ø 8.3 x 5 cm 40 Print Code: E(4)



Trend 5693

Emergency Light. 15 Leds. 9 Light Modes. Fixed and Flashing. Magnetic. 3 Batteries AAA Not Included.
 Nottlicht. 15 Leds. 9 Lichtpositionen, Festes und Blinkendes. Magnetisch. 3 AAA Batterien Nicht im Lieferumfang.
 Lumière Urgence. 15 Leds. 9 Modes de Lumière, Fixe et Clignotante. Magnétique. 3 Piles AAA Non Incluses.
 Noodlicht. 15 Leds. 9 Licht Posities, Vast en Knipperend. Magnetisch. 3 Batterijen AAA Niet Inclusief.

Ø 10 x 3.5 cm 100 / 50 Print Code: E(4)



05F

07F

Kross 8025

Reflective Vest. Polyester. One Size. Adult. Homologated.
 Warnweste. Polyester. Einheitsgröße. Erwachsene. Zugelassen.
 Gilet Réfléchissant. Polyester. Taille Unique. Adulte. Homologué.
 Reflecterend Vest. Polyester. Eén Maat. Volwassen. Gehomologiseerd.

65 x 70 cm 100 / 20 Print Code: G(6), N(8)



Jestol 2111

Reflective Vest. Polyester. One Size. Adult. Homologated.
 Warnweste. Polyester. Einheitsgröße. Erwachsene. Zugelassen.
 Gilet Réfléchissant. Polyester. Taille Unique. Adulte. Homologué.
 Reflecterend Vest. Polyester. Eén Maat. Volwassen. Gehomologiseerd.

65 x 70 cm 100 / 20 Print Code: G(6), N(8)





19 03 02

Wen 3761

Pressure Gauge. Aluminium.
 Reifendruckmesser. Aluminium.
 Mesureur Pression. Aluminium.
 Drukmeter. Aluminium.

📏 Ø 0.8 x 8 cm 📦 1000 / 100 🖨️ Print Code: D(1), L1



Quint 4915 210 X 130 CM CM

Space Blanket. Metallized PET.
 Rettungsdecke. Aluminisiertes PET.
 Couverture Thermique. PET Aluminisé.
 Heelal Deken. Aluminium Coated PET.

📏 210 x 130 cm 📦 200 / 50 🖨️ Print Code: D(1)



Gamp 5287

Alcohol Tester. 2 Batteries AAA Not Included.
 Alkoholtester. 2 AAA Batterien Nicht im Lieferumfang.
 Alcool Test. 2 Piles AAA Non Incluses.
 Alcohol Tester. 2 Batterijen AAA Niet Inclusief.

📏 3.6 x 9.5 x 1.7 cm 📦 200 / 50 🖨️ Print Code: E(4)



03

19

01

Dasha 3760

Ice Scraper. Polyester 210T.
Eiskratzer. Polyester 210T.
Gratte-Glace. Polyester 210T.
Ijskrabber. Polyester 210T.

17 × 25 × 1.5 cm

100 / 20

Print Code: E(1), N(8)

02



19

03

Feniok 5259

Ice Scraper.
Eiskratzer.
Gratte-Glace.
Ijskrabber.

8.8 × 21.2 × 1.3 cm

200 / 50

Print Code: D(4)

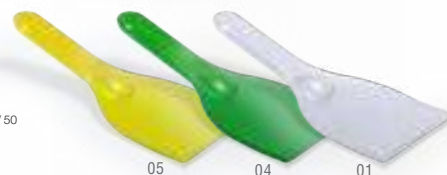

05

04

01



Skabix 6041

Snow Shovel. Carbon Steel. Foldable. Polyester Pouch.
Schneeschaufel. Kohlenstoff Stahl. Faltbar. Polyester Etui.
Pelle à Neige. Acier Carbone. Pliable. Étui Polyester.
Sneeuwschep. Carbon-Staal. Opvouwbaar. Polyester Zakje.

11.5 × 46.5 × 5 cm

20

Print Code: I(8), L2



Ice scraper



bamboo

Nafa 20416

Ice Scraper. Bamboo/ Silicone
 Eiskratzer. Bambus/ Silikon.
 Gratte-Glace. Bambou/ Silicone
 Ijskrabber. Bamboe/ Siliconen.

12.4 x 10.8 x 0.6 cm 200 / 50 Print Code: D(4), L2



Guñon 1862

Ice Scraper. Wheat Straw/ PP.
 Eiskratzer. Weizenstroh/ PP.
 Gratte-Glace. Paille de Blé/ PP.
 Ijskrabber. Tarwestro/ PP.

9.3 x 20.5 x 2 cm 200 / 50 Print Code: D(4)

New



Ucko 20418

Ice Scraper Keyring. Wheat Straw/ PS/ TPR.
 Eiskratzer Schlüsselanhänger. Weizenstroh/ PS/ TPR.
 Porte-Clés Gratte-Glace. Paille de Blé/ PS/ TPR.
 Ijskrabber Sleutelhanger. Tarwestro/ PS/ TPR.

5 x 5.5 x 0.3 cm 500 / 100 Print Code: C(4)

New



Nigex 20417

Ice Scraper. Bamboo/ Wheat Straw/ PP.
 Eiskratzer. Bambus/ Weizenstroh/ PP.
 Gratte-Glace. Bambou/ Paille de Blé/ PP.
 Ijskrabber. Bamboe/ Tarwestro/ PP.

9.5 x 22.5 x 2 cm 200 / 50 Print Code: D(4), L1



Fangiox 21004

Keyring. Metal/ Bamboo.
Schlüsselanhänger. Metall/ Bambus.
Porte-Clés. Métal/ Bambou.
Sleutelhanger. Metaal/ Bamboe.

2,4 x 5 x 0,4 cm 200 / 50
 Print Code: D(1), L1



MADE FROM
-RECYCLED-
LEATHER



Fostel 20188

Keyring. Recycled Leather/ Metal.
Schlüsselanhänger. Recycling Leder/ Metall.
Porte-Clés. Cuir Recyclé/ Métal.
Sleutelhanger. Gerecycled Leer/ Metaal.

5,6 x 2,5 x 0,4 cm 300 / 50
 Print Code: D(1), L1

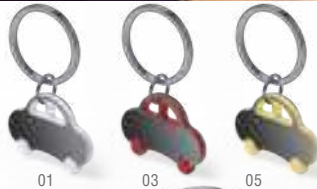

01

03

05



19

Rader 5358

Keyring. Stainless Steel.
Schlüsselanhänger. Rostfreier Stahl.
Porte-Clés. Acier Inox.
Sleutelhanger. Roestvrij Staal.

4,2 x 3 x 0,4 cm 300 / 50 Print Code: D(1), L1



Engine 9642

Keyring. Metal.
Schlüsselanhänger. Metall.
Porte-Clés. Métal.
Sleutelhanger. Metaal.

4,3 x 3 x 0,5 cm 400 / 50 Print Code: D(1), L1



Dazler 20415

Holder.
Halter.
Support.
Holder.

10.5 x 11.5 x 9 cm 100 / 20
Print Code: E(1)



Nardelly 5624

19

Organizer. Non-Woven.
Ordner. Non-Woven.
Organiseur. T.N.T.
Organizer. Non-Woven.

34 x 28 x 25 cm 40
Print Code: G(1), N(8)



Helron 1180

Cable Pouch. Polyester 600D RPET.
Kabeltasche. Polyester 600D RPET.
Sac de Câble. Polyester 600D RPET.
Kabeltas. Polyester 600D RPET.

Ø 39 x 12 cm 50 Print Code: K(8)

RPET



Birdy 1186



Sunshade. Polyester UV Protection. Polyester Pouch.
 Autosonnenschutz. Polyester UV Schutz. Polyester Etui.
 Pare-Soleil. Polyester Protection UV. Étui Polyester.
 Zonnescherm. Polyester UV Bescherming. Polyester Zakje.

140 x 75 cm 30 Print Code: G(1), N(8)



01



02



SUBLIMATION

Korenty 1596



Sunshade. Polyester. 2 Pieces. Foldable. Polyester Pouch.
 Autosonnenschutz. Polyester. 2 Stück. Faltpar. Polyester Etui.
 Pare-Soleil. Polyester. 2 Pièces. Pliable. Étui Polyester.
 Zonnescherm. Polyester. 2 Stuks. Opvouwbaar. Polyester Zakje.

44 x 36 cm 200 Print Code: G(1), R



150 x 70 CM

Sertark 1594



Sunshade. Polyester 170T. Foldable. Polyester Pouch.
 Autosonnenschutz. Polyester 170T. Faltpar. Polyester Etui.
 Pare-Soleil. Polyester 170T. Pliable. Étui Polyester.
 Zonnescherm. Polyester 170T. Opvouwbaar. Polyester Zakje.

150 x 70 cm 100 Print Code: G(1)





New



130 x 70 CM



Harmuny 20413

Sunshade. Two Bubble Recycled Aluminium Sides.
 Autosonnenschutz. Recycling Aluminium Luftblasen Beidseitig.
 Pare-Soleil. Aluminium Recyclé Bulles Deux Faces.
 Zonnescherm. Tweezijdig Gerecycled Aluminium Bubbelfolie.

130 x 70 cm 50 Print Code: H(1)



New



150 x 70 CM



Eldoris 20414

Sunshade. Aluminium One Side.
 Autosonnenschutz. Aluminium Einseitig.
 Pare-Soleil. Aluminium Un Côté.
 Zonnescherm. Aluminium Eenzijdig.

150 x 70 cm 100 Print Code: H(1)



Xaton 1595

Sunshade. Two Bubble Aluminium Sides.
 Autosonnenschutz. Aluminium Luftblasen Beidseitig.
 Pare-Soleil. Aluminium Bulles Deux Faces.
 Zonnescherm. Tweezijdig Aluminium Bubbelfolie.

130 x 70 cm 100 Print Code: H(1)



Falnit 5708

Sunshade. Two Bubble Aluminium Sides.
 Autosonnenschutz. Aluminium Luftblasen Beidseitig.
 Pare-Soleil. Aluminium Bulles Deux Faces.
 Zonnescherm. Tweezijdig Aluminium Bubbelfolie.

130 x 80 cm 100 Print Code: H(1)



Fussion 8100

Sunshade. Aluminium One Side.
 Autosonnenschutz. Aluminium Einseitig.
 Pare-Soleil. Aluminium Un Côté.
 Zonnescherm. Aluminium Eenzijdig.

130 x 60 cm 100 Print Code: H(1)



Jumbo 9124

Sunshade. Aluminium One Side.
 Autosonnenschutz. Aluminium Einseitig.
 Pare-Soleil. Aluminium Un Côté.
 Zonnescherm. Aluminium Eenzijdig.

130 x 70 cm 100 Print Code: H(1)



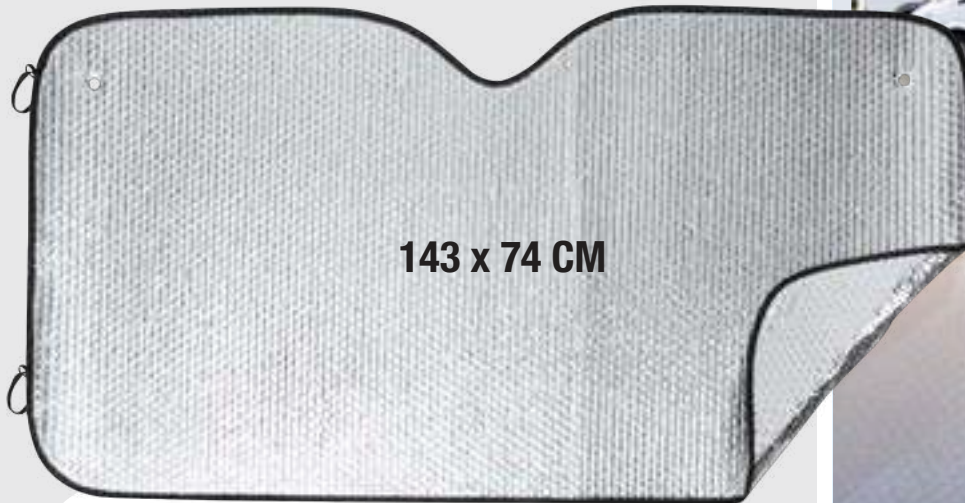

143 x 74 CM



Vagón 9173

Sunshade. Two Bubble Aluminium Sides.
Autosonnenschutz. Aluminium Luftblasen Beidseitig.
Pare-Soleil. Aluminium Bulles Deux Faces.
Zonnescherm. Tweezijdig Aluminium Bubbelfolie.

143 x 74 cm 100 Print Code: H(1)



SUNSHADE
BIG SIZE

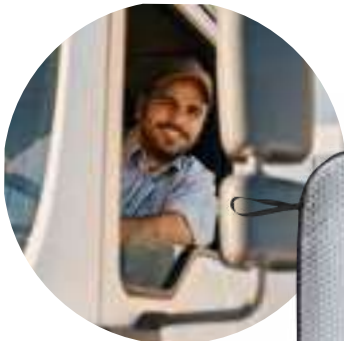

Belgiox 5709

Sunshade. Two Bubble Aluminium Sides.
Autosonnenschutz. Aluminium Luftblasen Beidseitig.
Pare-Soleil. Aluminium Bulles Deux Faces.
Zonnescherm. Tweezijdig Aluminium Bubbelfolie.

180 x 90 cm 50 Print Code: H(1)



BIG SIZE
180 x 90 CM

22 TOOLS & DIY





**PRACTICAL,
MULTIFUNCTIONAL,
ESSENTIAL**

BAMBOO tools



Dichen 1m 20494

Tape Measure. Bamboo.
Maßband. Bambus.
Mètre Grade. Bambou.
Meetlint. Bamboe.

5 × 5 × 1.8 cm 300 / 100 Print Code: D(4), L1, W



Sitong 1m 1619

Opener Tape Measure. Bamboo.
Flaschenöffner Maßband. Bambus.
Mètre Grade Ouvre Bouteille. Bambou.
Opener Meetlint. Bamboe.

Ø 5 × 2.3 cm 200 / 50 Print Code: D(4), L1, W



Nish 20495

Multifunction Keyring. Bamboo.
Multifunktion Schlüsselanhänger. Bambus.
Porte-Clés Multifonction. Bambou.
Multifunctioneel Houder. Bamboe.

6 × 8 × 1.5 cm 200 / 100 Print Code: D(4), L1



Nudok 1583

Bottle Opener Level. Bamboo.
Flaschenöffner Level. Bambus.
Level Ouvre Bouteille. Bambou.
Opener Level. Bamboe.

15 × 4.8 × 2 cm 100 / 50 Print Code: D(4), L1, W



Lirson 20501

Cutter. Bamboo.
Cutter. Bambou.
Cutter. Bambou.
Cutter. Bamboe.

1.8 × 13 × 1.4 cm 600 / 50 Print Code: C(4), L1



Denwa 1m 20474

Multitool Tape Measure. Bamboo/ Stainless Steel. 7 Functions.
 Multiwerkzeug Maßband. Bambus/ Rostfreier Stahl. 7 Funktionen.
 Mètre Grade Multi Outils. Bambou/ Acier Inox. 7 Fonctions.
 Multitool Meetlint. Bamboe/ Roestvrij Staal. 7 Functies.

5.8 × 8.9 × 1.9 cm 200 / 100
 Print Code: D(4), L1, W

BAMBOO & BLACK tools



Ruselton 20472

Multitool. Bamboo/ Carbon Steel. 7 Functions.
 Multiwerkzeug. Bambus/ Kohlenstoff Stahl. 7 Funktionen.
 Multi Outils. Bambou/ Acier Carbone. 7 Fonctions.
 Multitool. Bamboe/ Carbon-Staal. 7 Functies.

3.2 × 9.8 × 2 cm 100 / 20
 Print Code: D(4), L1



Eliza 3m 20508

Multitool Tape Measure. Bamboo/ ABS. 5 Accessories. 7 Functions.
 Multiwerkzeug Maßband. Bambus/ ABS. 5 Teile. 7 Funktionen.
 Mètre Grade Multi Outils. Bambou/ ABS. 5 Accessoires. 7 Fonctions.
 Multitool Meetlint. Bamboe/ ABS. 5 Accessoires. 7 Functies.

9.6 × 6 × 2.2 cm 100 / 50
 Print Code: D(4), L1



Wilco 1m 20471

Multitool Tape Measure. Bamboo/ ABS. 1 Led. 2 Accessories. Button Batteries Included.
 Multiwerkzeug Maßband. Bambus/ ABS. 1 Led. 2 Teile. Knopfzellen inklusive.
 Mètre Grade Multi Outils. Bambou/ ABS. 1 Led. 2 Accessoires. Piles Bouton Incluses.
 Multitool Meetlint. Bamboe/ ABS. 1 Led. 2 Accessoires. Knoopcel Batterijen Inclusief.

Ø 5.8 × 1.9 cm 200 / 100
 Print Code: D(1), L1

WHEAT STRAW

Sanwel 3m 1618

Multifunction Tape Measure. Wheat Straw/ ABS. 12 Sticky Notes 4,5 x 4,5 cm. With Brake and Clip. Pen Included.
 Multifunktion Maßband. Weizenstroh/ ABS. 12 Haftnetzen 4,5 x 4,5 cm. Mit Bremse und Gürtelclip. Kugelschreiber Inklusiv.
 Mètre Grade Multifonction. Paille de Blé/ ABS. 12 Notes Adhésives 4,5 x 4,5 cm. Avec Frein et Clip. Stylo Inclusif.
 Multifunctioneel Meetlint. Tarwestro/ ABS. 12 Plakmemo's 4,5 x 4,5 cm. Met Rem en Clip. Pen Inclusief.

7.9 x 5.9 x 3 cm 100 / 50 Print Code: E(1), W



Hermy 5m 1213

Tape Measure. Bamboo/ ABS. With Brake and Clip Included.
 Maßband. Bambus/ ABS. Mit Bremse und Gürtelclip Inklusiv.
 Mètre Grade. Bambou/ ABS. Avec Frein et Clip Inclusif.
 Meetlint. Bamboe/ ABS. Met Rem en Clip Inclusief.

6.9 x 6.9 x 3.8 cm 50 / 10 Print Code: E(4), L1



Lusim 1m 1577

Tape Measure. Bamboo/ ABS. Clip Included.
 Maßband. Bambus/ ABS. Gürtelclip Inklusiv.
 Mètre Grade. Bambou/ ABS. Clip Inclusif.
 Meetlint. Bamboe/ ABS. Clip Inclusief.

4.4 x 6.5 x 1.3 cm 500 / 50 Print Code: D(4), L1



Liam 1m 1343

Opener Tape Measure.
 Flaschenöffner Maßband.
 Mètre Grade Ouvre Boutelle.
 Opener Meetlint.

4.5 x 4.5 x 1 cm 500 / 50 Print Code: D(4), W

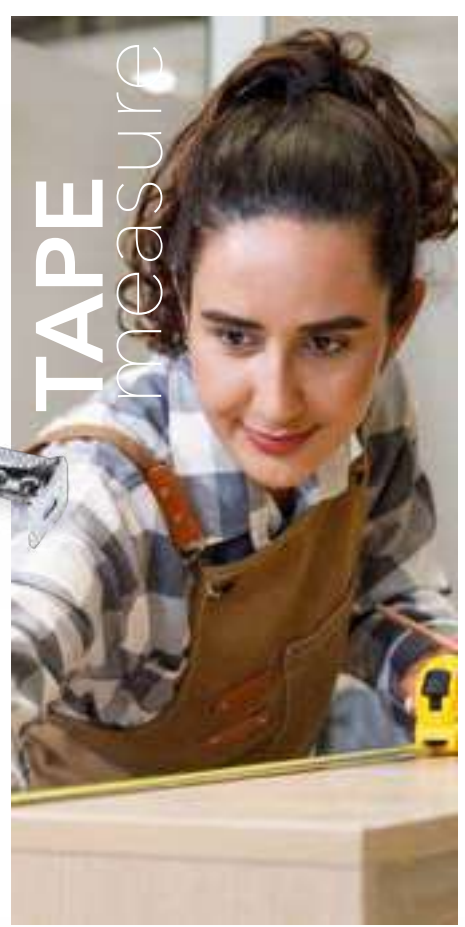

TAPE
measure

Harrol 1m 5547

Tape Measure. With Brake.
Maßband. Mit Bremse.
Mètre Grade. Avec Frein.
Meetlint. Met Rem.

6x6x6 4.3 x 4.1 x 1.5 cm

120 / 12

Print Code: D(1), V

Turner 5m 20500

Tape Measure. With Brake and Clip Included.
Maßband. Mit Bremse und Gürtelclip Inklusiv.
Mètre Grade. Avec Frein et Clip Inclusive.
Meetlint. Met Rem en Clip Inclusief.

8x7x3.5 8 x 7.1 x 3.5 cm

50 / 10

Print Code: E(1), V



Grade 3m 3020

Tape Measure. With Brake and Clip Included.
Maßband. Mit Bremse und Gürtelclip Inklusiv.
Mètre Grade. Avec Frein et Clip Inclusive.
Meetlint. Met Rem en Clip Inclusief.

6x6x6 6 x 6 x 6 cm

120 / 12

Print Code: E(1), V

Grade 5m 4643

Tape Measure. With Brake and Clip Included.
Maßband. Mit Bremse und Gürtelclip Inklusiv.
Mètre Grade. Avec Frein et Clip Inclusive.
Meetlint. Met Rem en Clip Inclusief.

7x7x3.5 7 x 7 x 3.5 cm

50 / 10

Print Code: E(1), V

Grade 7,5m 6411

Tape Measure. With Brake and Clip Included.
Maßband. Mit Bremse und Gürtelclip Inklusiv.
Mètre Grade. Avec Frein et Clip Inclusive.
Meetlint. Met Rem en Clip Inclusief.

8.5x8.5x4.5 8.5 x 8.5 x 4.5 cm

40 / 10

Print Code: E(1), V



New



Margorix 20477

Multitool. Bamboo/ Carbon Steel. 1 Accessoire. 5 Fonctions. Jumbo Refill.
 Multiwerkzeug. Bambus/ Kohlenstoff Stahl. 1 Teil. 5 Funktionen. Jumbo Mine.
 Multi Outils. Bambou/ Acier Carbone. 1 Accessoire. 5 Fonctions. Recharge Jumbo.
 Multitool. Bamboe/ Carbon-Staal. 1 Accessoire. 5 Functies. Jumbo Refill.

15 x 2 x 4 cm 50 Print Code: E(1)



Delint 1578



Pencil. Wood.
 Bleistift. Holz.
 Crayon. Bois.
 Potlood. Hout.

1.2 x 17.2 x 0.7 cm 1000 / 100 Print Code: A(1), L1, W



03



04

19

05

02

Carpintero 8876



Pencil. Wood.
 Bleistift. Holz.
 Crayon. Bois.
 Potlood. Hout.

Ø 1.2 x 17.6 cm 1000 / 100 Print Code: A(1), L1, W



SHARPENED

+10.000 uds
 PRINTING 12% Dto.

Miniature 9607

Pencil. Wood.
 Bleistift. Holz.
 Crayon. Bois.
 Potlood. Hout.

Ø 0.5 x 10 cm 2000 / 100 Print Code: A(4), L1

Medil 1579

Ruler. Wood. 2 M. Foldable.
Lineal. Holz. 2 M. Faltbar.
Règle. Bois. 2 M. Pliable.
Linaal. Hout. 2 M. Opvouwbaar.

 24 x 1.7 x 3.5 cm  100 / 10  Print Code: E(f), L2



6in1
MULTI-
FUNCTION

Rakars 1581

Multifunction Pen. Bamboo. 1 Accessorie. 6 Functions.
Multifunktion Kugelschreiber. Bambus. 1 Teil. 6 Funktionen.
Stylo Multifonction. Bambou. 1 Accessoire. 6 Fonctions.
Multifunctioneel Pen. Bamboe. 1 Accessoire. 6 Functies.

 Ø 1.2 x 15.1 cm  500 / 50  Print Code: B(4), L1



Suriak 1580

Multifunction Eternal Pencil. Bamboo. 3 Functions.
Multifunktion Ewiger Bleistift. Bambus. 3 Funktionen.
Crayon Éternel Multifonction. Bambou. 3 Fonctions.
Multifunctioneel Bleistift. Bamboe. 3 Functies.

 Ø 1 x 14.8 cm  500 / 50  Print Code: B(4), L1



ETERNAL WRITING



Blauden 3450

Multitool. Aluminium/ Stainless Steel. 12 Functions. Polyester Pouch.
 Multiwerkzeug. Aluminium/ Rostfreier Stahl. 12 Funktionen. Polyester Etui.
 Multi Outils. Aluminium/ Acier Inox. 12 Fonctions. Étui Polyester.
 Multitool. Aluminium/ Roestvrij Staal. 12 Functies. Polyester Zakje.

5 x 10.5 x 1.7 cm 100 / 10 Print Code: E(4), L1



Borth 7291

Multitool. Aluminium/ Stainless Steel. 6 Functions.
 Multiwerkzeug. Aluminium/ Rostfreier Stahl. 6 Funktionen.
 Multi Outils. Aluminium/ Acier Inox. 6 Fonctions.
 Multitool. Aluminium/ Roestvrij Staal. 6 Functies.

2.8 x 8.4 x 1.5 cm 100 / 10 Print Code: E(1), L1



swisent
ORIZONS[®]
 adventure



Wicax 4208

Multitool. Stainless Steel. 11 Functions. PU Pouch.
 Multiwerkzeug. Rostfreier Stahl. 11 Funktionen. PU Etui.
 Multi Outils. Acier Inox. 11 Fonctions. Étui Similicuir.
 Multitool. Roestvrij Staal. 11 Functies. PU Zakje.

8 x 5.5 x 0.3 cm 400 / 100 Print Code: D(1), L1



Blizen 4305

Multitool. Aluminium. 6 Accessories.
 Multiwerkzeug. Aluminium. 6 Teile.
 Multi Outils. Aluminium. 6 Accessoires.
 Multitool. Aluminium. 6 Accessoires.

Ø 1.3 x 11 cm 200 / 50 Print Code: C(1), L1



Loulan 20503

3 in 1
MULTI-FUNCTION

Multitool. Aluminium. 2 Accessoires. 3 Functies.
Multiwerkzeug. Aluminium. 2 Teile. 3 Funktionen.
Multi Outils. Aluminium. 2 Accessoires. 3 Fonctions.
Multitool. Aluminium. 2 Accessoires. 3 Functies.

Ø 1.2 x 13.1 cm 200 / 100 Print Code: C(1), L1

Tulix 20504

8 in 1
MULTI-FUNCTION

Multifunction Pen. Stainless Steel. 1 Accessoire. 8 Functies.
Multifunktion Kugelschreiber. Rostfreier Stahl. 1 Teil. 8 Funktionen.
Stylo Multifonction. Acier Inox. 1 Accessoire. 8 Fonctions.
Multifunctioneel Pen. Roestvrij Staal. 1 Accessoire. 8 Functies.

1.3 x 16.3 x 1.3 cm 200 / 50 Print Code: C(1), L1

Posdan 20478

7 in 1
MULTI-FUNCTION

Multifunction Pen. 1 Accessoire. 7 Functies. Button Batteries Included.
Multifunktion Kugelschreiber. 1 Teil. 7 Funktionen. Knopfzellen Inklusiv.
Stylo Multifonction. 1 Accessoire. 7 Fonctions. Piles Bouton Incluses.
Multifunctioneel Pen. 1 Accessoire. 7 Functies. Knopcel Batterijen Inclusief.

Ø 1.3 x 14.6 cm 500 / 100 Print Code: C(1), L1



Thirty 9774

Scale Ruler. Aluminium. 30 cm. Scales: 1:20, 1:25, 1:50, 1:75, 1:100.
 Maßstab. Aluminium. 30 cm. Skala: 1:20, 1:25, 1:50, 1:75, 1:100.
 Règle. Aluminium. 30 cm. Échelle: 1:20, 1:25, 1:50, 1:75, 1:100.
 Lineaal. Aluminium. 30 cm. Schaal: 1:20, 1:25, 1:50, 1:75, 1:100.

32 x 2 x 2 cm 200 / 20 Print Code: F(4), L1



Koltom 5548

Cutter.
Cutter.
Cutter.
Cutter.

3 x 15.5 x 1.4 cm 500 / 100 Print Code: C(4)



Gruesly 5549

Cutter. Aluminium.
Cutter. Aluminium.
Cutter. Aluminium.
Cutter. Aluminium.

4 x 15.5 x 2.2 cm 100 / 25 Print Code: C(1)



Fainel 5550

Cutter. Stainless Steel.
Cutter. Rostfreier Stahl.
Cutter. Acier Inox.
Cutter. Roestvrij Staal.

1.2 x 12.7 x 1.1 cm 800 / 100 Print Code: L1

WHEAT STRAW tools

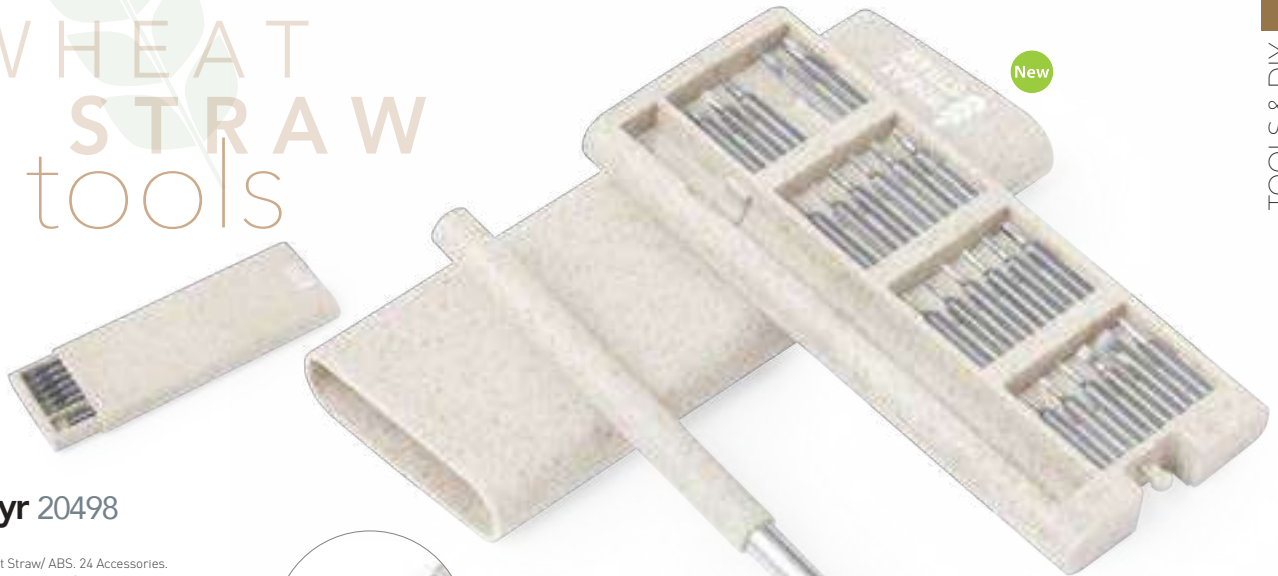

New

Zephyr 20498

Tool Set. Wheat Straw/ ABS. 24 Accessories.
 Werkzeug Set. Weizenstroh/ ABS. 24 Teile.
 Set Outils. Paille de Blé/ ABS. 24 Accessoires.
 Gereedschaps Set. Tarwestro/ ABS. 24 Accessoires.

16.6 x 1.8 x 6.8 cm 50 Print Code: E(1), W



New



Rowe 20499

Cutter. Wheat Straw/ ABS.
 Cutter. Weizenstroh/ ABS.
 Cutter. Paille de Blé/ ABS.
 Cutter. Tarwestro/ ABS.

3 x 15.5 x 1.4 cm 500 / 100 Print Code: C(4)



New

Drankil 1m 20479

Multitool Tape Measure. Wheat Straw/ ABS. 6 Accessories.
 Multiwerkzeug Maßband. Weizenstroh/ ABS. 6 Teile.
 Mètre Grade Multi Outils. Paille de Blé/ ABS. 6 Accessoires.
 Multitool Meetlint. Bamboe/ ABS. 6 Accessoires.

10.8 x 6.3 x 2.1 cm 200 / 100 Print Code: D(4)



New



Sacana 20480

Multitool. Wheat Straw/ ABS. 10 Accessories.
 Multiwerkzeug. Weizenstroh/ ABS. 10 Teile.
 Multi Outils. Paille de Blé/ ABS. 10 Accessoires.
 Multitool. Tarwestro/ ABS. 10 Accessoires.

Ø 2.4 x 13.3 cm 200 / 50
 Print Code: D(4)

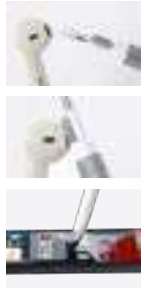

Gobit 20749

Cleaner Pen. 4 Functions.
Reinigungs Kugelschreiber. 4 Funktionen.
Stylo Nettoyeur. 4 Fonctions.
Reinigungs Pen. 4 Functies.

Ø 1.2 x 14 cm 400 / 100 Print Code: B(4)

New



02

01



Payro 5791

7 in 1 Multifunction Pen. 1 Accessoire. 7 Functions.
7 in 1 Multifunktion Kugelschreiber. 1 Teil. 7 Funktionen.
Stylo Multifonction 7 en 1. 1 Accessoire. 7 Fonctions.
7 in 1 Multifunctioneel Pen. 1 Accessoire. 7 Functies.

1.6 x 15.5 x 1.2 cm 500 / 50 Print Code: B(4)

09 04 02 03

7 in 1
MULTI-FUNCTION

19

Sauris 4402

Multifunction Pen. 1 Accessoire. 5 Functions.
Multifunktion Kugelschreiber. 1 Teil. 5 Funktionen.
Stylo Multifonction. 1 Accessoire. 5 Fonctions.
Multifunctioneel Pen. 1 Accessoire. 5 Functies.

Ø 1 x 14.9 cm 1000 / 50 Print Code: B(4)



09 01 19 03

5 in 1
MULTI-FUNCTION

02



02 03 19



01

New

Lexi 21011

Multifunction Pen. Aluminium. 1 Accessoire. 5 Functions.
Multifunktion Kugelschreiber. Aluminium. 1 Teil. 5 Funktionen.
Stylo Multifonction. Aluminium. 1 Accessoire. 5 Fonctions.
Multifunctioneel Pen. Aluminium. 1 Accessoire. 5 Functies.

Ø 1.1 x 9.2 cm 500 / 100 Print Code: C(1), L1

5 in 1
MULTI-FUNCTION

01 02

AL RECYCLED
Aluminium3 in 1
MULTI-FUNCTION

Teluk 1680

Multifunction Eternal Pencil. Recycled Aluminium. 3 Functions.
Multifunktion Ewiger Bleistift. Recycling Aluminium. 3 Funktionen.
Crayon Éternel Multifonction. Aluminium Recyclé. 3 Fonctions.
Multifunctioneel Bleistift. Gerecycled Aluminium. 3 Functies.

1.4 x 14.8 x 1.4 cm 500 / 50 Print Code: B(4), L1



06

Contal 5119

Multifunction Pen. 3 Functions.
Multifunktion Kugelschreiber. 3 Funktionen.
Stylo Multifonction. 3 Fonctions.
Multifunctioneel Pen. 3 Functies.

Ø 1.1 x 14.8 cm 1000 / 50 Print Code: B(4)

3 in 1
MULTI-FUNCTION

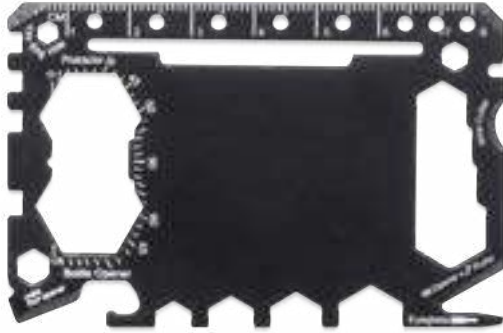

Frest 1592

Multitool. Stainless Steel. 17 Functions. PU Pouch.
 Multiwerkzeug. Rostfreier Stahl. 17 Funktionen. PU Etui.
 Multi Outils. Acier Inox. 17 Fonctions. Étui Similitcuir.
 Multitool. Roestvrij Staal. 17 Functies. PU Zakje.

9.4 x 6.4 x 0.2 cm 400 / 100 Print Code: D(1), L1



New

Vireon 20487

Multitool. Stainless Steel. 1 Led. 16 Functions. Button Batteries Included.
 Multiwerkzeug. Rostfreier Stahl. 1 Led. 16 Funktionen. Knopfzellen Inklusive.
 Multi Outils. Acier Inox. 1 Led. 16 Fonctions. Piles Bouton Incluses.
 Multitool. Roestvrij Staal. 1 Led. 16 Functies. Knopcel Batterijen Inclusief.

8.5 x 5.3 x 0.9 cm 200 / 100 Print Code: D(1), L1



Torkul 1591

Multitool. Stainless Steel. 17 Functions.
 Multiwerkzeug. Rostfreier Stahl. 17 Funktionen.
 Multi Outils. Acier Inox. 17 Fonctions.
 Multitool. Roestvrij Staal. 17 Functies.

6.3 x 6.3 x 0.8 cm 100 / 50 Print Code: D(1), L1



New

Sekmed 20482

Multitool. Stainless Steel. 10 Functions.
 Multiwerkzeug. Rostfreier Stahl. 10 Funktionen.
 Multi Outils. Acier Inox. 10 Fonctions.
 Multitool. Roestvrij Staal. 10 Functies.

3.8 x 10 x 1 cm 200 / 100 Print Code: D(1), L1



New

Valixia 20481

Multitool. Aluminium/ Stainless Steel. 13 Functions.
 Multiwerkzeug. Aluminium/ Rostfreier Stahl. 13 Funktionen.
 Multi Outils. Aluminium/ Acier Inox. 13 Fonctions.
 Multitool. Aluminium/ Roestvrij Staal. 13 Functies.

3.9 x 8.6 x 1 cm 200 / 50 Print Code: D(1), L1



Congus 5675

Tool Set. 19 Accessories.
 Werkzeug Set. 19 Teile.
 Set Outils. 19 Accessoires.
 Gereedschaps Set. 19 Accessoires.

15 x 9 x 2 cm 40 Print Code: F(1)



Ambery 1215

Tool Set. Aluminium. 25 Accessories.
 Werkzeug Set. Aluminium. 25 Teile.
 Set Outils. Aluminium. 25 Accessoires.
 Gereedschaps Set. Aluminium. 25 Accessoires.

20,3 x 2,9 x 14 cm 20 Print Code: F(1), L2



Mostik 5677

Tool Set. 4 Leds. 21 Accessories. Button Batteries Included.
 Werkzeug Set. 4 Leds. 21 Teile. Knopfzellen Inklusiv.
 Set Outils. 4 Leds. 21 Accessoires. Piles Bouton Incluses.
 Gereedschaps Set. 4 Leds. 21 Accessoires. Knopcel Batterijen Inclusief.

20 x 12 x 4,6 cm 20 Print Code: F(2)



Wheels 5676

Tool Set. 20 Accessories.
 Werkzeug Set. 20 Teile.
 Set Outils. 20 Accessoires.
 Gereedschaps Set. 20 Accessoires.

Ø 12,9 x 4,9 cm 30 Print Code: F(2)



Layla 20496

Multitool. 1 Led. 19 COB Lights. 2 Light Modes, Fixed and Flashing. 13 Functions. Magnetic. 3 Piles AAA Non Included.

Multiwerkzeug. 1 Led. 19 COB Lichter. 2 Lichtpositionen, Festes und Blinkendes. 13 Funktionen. Magnetisch. 3 AAA Batterien Nicht im Lieferumfang.

Multi Outils. 1 Led. 19 Lumières COB. 2 Modes de Lumière, Fixe et Clignotante. 13 Fonctions. Magnétique. 3 Piles AAA Non Incluses.

Multitool. 1 Led. 19 COB Lichten. 2 Licht Posities, Vast en Knipperend. 13 Functies. Magnetisch. 3 Batterijen AAA Niet Inclusief.

4.6 x 16.8 x 3.1 cm 50 Print Code: E(1), L1



Hancuk 20497

Tool Set. 4 Leds. 2 Light Modes, Fixed and Flashing. 21 Accessories. 3 Piles AAA Non Included.

Werkzeug Set. 4 Leds. 2 Lichtpositionen, Festes und Blinkendes. 21 Teile. 3 AAA Batterien Nicht im Lieferumfang.

Set Outils. 4 Leds. 2 Modes de Lumière, Fixe et Clignotante. 21 Accessoires. 3 Piles AAA Non Incluses.

Gereedschaps Set. 4 Leds. 2 Licht Posities, Vast en Knipperend. 21 Accessoires. 3 Batterijen AAA Niet Inclusief.

12.6 x 17.5 x 4.8 cm 20 Print Code: F(2)



Vizcaya 8534

Tool Set. 1 Led. 24 Accessories. 4 Batteries AA Not Included.

Werkzeug Set. 1 Led. 24 Teile. 4 AA Batterien Nicht im Lieferumfang.

Set Outils. 1 Led. 24 Accessoires. 4 Piles AA Non Incluses.

Gereedschaps Set. 1 Led. 24 Accessoires. 4 Batterijen AA Niet Inclusief.

19 x 9.5 x 12.5 cm 20 Print Code: F(2)



Teigel 1530

Tool Set. 24 Leds Lights. Adjustable Brightness. 30 Accessories. 3 Piles AA Non Included.

Werkzeug Set. 24 Leds. Einstellbare Lichtintensität. 30 Teile. 3 AA Batterien Nicht im Lieferumfang.

Set Outils. 24 Leds. Lumière à Intensité Réglable. 30 Accessoires. 3 Piles AA Non Incluses.

Gereedschaps Set. 24 Leds. Lamp met Instelbare Lichtintensiteit. 30 Accessoires. 3 Batterijen AA Niet Inclusief.

19.5 x 5.5 x 15.5 cm 15 Print Code: F(2)





New



Rosen 20483

Tool Set. Bamboo. 15 Accessories.
 Werkzeug Set. Bambus. 15 Teile.
 Set Outils. Bambou. 15 Accessoires.
 Gereedschaps Set. Bamboe. 15 Accessoires.

18 x 3.3 x 17.5 cm 15 Print Code: F(1), L2, W



New



Belamy 20493

Tool Set. Cork. 24 Accessories.
 Werkzeug Set. Kork. 24 Teile.
 Set Outils. Liège. 24 Accessoires.
 Gereedschaps Set. Kurk. 24 Accessoires.

15.5 x 4.2 x 10 cm 40 Print Code: F(1), L2, N(8)

Cork

BAMBOO



Raylok 1582

Tool Set. Bamboo. 19 Accessories.
 Werkzeug Set. Bambus. 19 Teile.
 Set Outils. Bambou. 19 Accessoires.
 Gereedschaps Set. Bamboe. 19 Accessoires.

23 x 2.6 x 11.4 cm 20 Print Code: F(1), L2, W



Bamboo Multitools



Craxin 1587

Multitool. Bamboo/ Stainless Steel. 13 Functions.

Multiwerkzeug. Bambus/ Rostfreier Stahl. 13 Funktionen.

Multi Outils. Bambou/ Acier Inox. 13 Fonctions.

Multitool. Bamboe/ Roestvrij Staal. 13 Functies.

7,1 x 14 x 2,4 cm 40 / 10
Print Code: E(4), L1



Folnax 6805

Multitool. Bamboo/ Stainless Steel. 12 Functions.

Multiwerkzeug. Bambus/ Rostfreier Stahl. 12 Funktionen.

Multi Outils. Bambou/ Acier Inox. 12 Fonctions.

Multitool. Bamboe/ Roestvrij Staal. 12 Functies.

5 x 10,5 x 1,7 cm 100 / 10
Print Code: E(4), L1

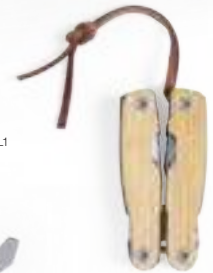

Sultan 6804

Pocket Knife. Bamboo/ Stainless Steel. Safety Lock Included.

Taschenmesser. Bambus/ Rostfreier Stahl. Sicherheitsverschluss.

Canif. Bambou/ Acier Inox. Avec Cran d'Arrêt.

Zakmes. Bamboe/ Roestvrij Staal. Met Veiligheidsblokkade.

9,8 x 2,5 x 1,4 cm 120 / 12
Print Code: E(4), L1



Titan 6803

Multifunction Pocket Knife. Bamboo/ Stainless Steel. 9 Functions.

Multifunktions-taschenmesser. Bambus/ Rostfreier Stahl. 9 Funktionen.

Canif Multi-Usages. Bambou/ Acier Inox. 9 Fonctions.

Multifunctioneel Zakmes. Bamboe/ Roestvrij Staal. 9 Functies.

9,4 x 2,5 x 1,5 cm 100 / 10
Print Code: E(4), L1



Kasuki 20484

Multifunction Pocket Knife. Bamboo/ Stainless Steel. 9 Functions.

Multifunktions-taschenmesser. Bambus/ Rostfreier Stahl. 9 Funktionen.

Canif Multi-Usages. Bambou/ Acier Inox. 9 Fonctions.

Multifunctioneel Zakmes. Bamboe/ Roestvrij Staal. 9 Functies.

9,3 x 3,5 x 1,6 cm 100 / 20
Print Code: E(4), L1



Komit 1590

Multifunction Pocket Knife, Aluminium/ Stainless Steel. 13 Functions.
 Multifunktions-taschenmesser. Aluminium/ Rostfreier Stahl. 13 Funktionen.
 Canif Multi-Usages. Aluminium/ Acier Inox. 13 Fonctions.
 Multifunctioneel Zakmes. Aluminium/ Roestvrij Staal. 13 Functies.

9.3 x 3.3 x 1.9 cm 100 / 10 Print Code: E(1), L1



Dailfot 1589

Multitool, Aluminium/ Stainless Steel. 13 Functions.
 Multiwerkzeug. Aluminium/ Rostfreier Stahl. 13 Funktionen.
 Multi Outils. Aluminium/ Acier Inox. 13 Fonctions.
 Multitool. Aluminium/ Roestvrij Staal. 13 Functies.

5.5 x 10.5 x 1.9 cm 50 / 10 Print Code: E(1), L1



Datrak 1588

Pocket Knife, Aluminium/ Stainless Steel. Safety Lock Included.
 Taschenmesser. Aluminium/ Rostfreier Stahl. Sicherheitsverschluss.
 Canif. Aluminium/ Acier Inox. Avec Cran d'Arrêt.
 Zakmes. Aluminium/ Roestvrij Staal. Met Veiligheidsblokkade.

10.1 x 3.1 x 1.3 cm 100 / 10 Print Code: E(1), L1



Brica 1585

Multifunction Pocket Knife, Cork/ Stainless Steel. 9 Functions.
 Multifunktions-taschenmesser. Cork/ Rostfreier Stahl. 9 Funktionen.
 Canif Multi-Usages. Liège/ Acier Inox. 9 Fonctions.
 Multifunctioneel Zakmes. Kurk/ Roestvrij Staal. 9 Functies.

9.4 x 2.5 x 1.5 cm 100 / 10 Print Code: E(4), L1



Ketlen 1584

Multitool, Cork/ Stainless Steel. 12 Functions.
 Multiwerkzeug. Cork/ Rostfreier Stahl. 12 Funktionen.
 Multi Outils. Liège/ Acier Inox. 12 Fonctions.
 Multitool. Kurk/ Roestvrij Staal. 12 Functies.

6.2 x 10.5 x 2.2 cm 100 / 10 Print Code: E(4), L1



Sarper 1586

Pocket Knife, Cork/ Stainless Steel. Safety Lock Included.
 Taschenmesser. Cork/ Rostfreier Stahl. Sicherheitsverschluss.
 Canif. Liège/ Acier Inox. Avec Cran d'Arrêt.
 Zakmes. Kurk/ Roestvrij Staal. Met Veiligheidsblokkade.

9.8 x 2.5 x 1.2 cm 120 / 12 Print Code: E(4), L1



Cork



Shaula 20485

Opener Torch. 30 COB Lights. 3 Light Modes, Fixed and Flashing. Magnetic. Batterie 300 mAh.
 Flaschenöffner Lampe. 30 COB Lichten. 3 Lichtpositionen, Festes und Blinkendes. Magnetisch. Batterie 300 mAh.
 Lampe Ouvrir Bouteille. 30 Lumières COB. 3 Modes de Lumière, Fixe et Clignotante. Magnétique. Batterie 300 mAh.
 Opener Zaklamp. 30 COB Lichten. 3 Licht Posities, Vast en Knipperend. Magnetisch. Batterij 300 mAh.

📏 4.5 × 6.1 × 2.1 cm 📦 200 / 50 🗑️ Print Code: D(1)



Argix 20486

Multitool. Aluminium. 20 COB Lights. 3 Light Modes, Fixed and Flashing. 10 Functions. Magnetic. Battery 500 mAh.
 Multiwerkzeug. Aluminium. 20 COB Lichten. 3 Lichtpositionen, Festes und Blinkendes. 10 Funktionen. Magnetisch. Batterie 500 mAh.
 Multi Outils. Aluminium. 20 Lumières COB. 3 Modes de Lumière, Fixe et Clignotante. 10 Fonctions. Magnétique. Batterie 500 mAh.
 Multitool. Aluminium. 20 COB Lichten. 3 Licht Posities, Vast en Knipperend. 10 Functies. Magnetisch. Batterij 500 mAh.

📏 5 × 9.5 × 3 cm 📦 50 🗑️ Print Code: E(1)



Borah 20492

Torch. Aluminium. 1 Led. 10 COB Lights. 2 Light Modes, Fixed and Flashing. Batterie 400 mAh.
 Lampe. Aluminium. 1 Led. 10 COB Lichten. 2 Lichtpositionen, Festes und Blinkendes. Batterie 400 mAh.
 Lampe. Aluminium. 1 Led. 10 Lumières COB. 2 Modes de Lumière, Fixe et Clignotante. Batterie 400 mAh.
 Zaklamp. Aluminium. 1 Led. 10 COB Lichten. 2 Licht Posities, Vast en Knipperend. Batterij 400 mAh.

📏 Ø 2.7 × 9.1 cm 📦 200 / 100 🗑️ Print Code: E(1), L1



Gimax 1663

Torch. Aluminium. 1 Led. 200 Lumens. Zoom. 3 Light Modes, Fixed and Flashing. 3 Batteries AA Not Included.
 Lampe. Aluminium. 1 Led. 200 Lumens. Zoom. 3 Lichtpositionen, Festes und Blinkendes. 3 AA Batterien Nicht im Lieferumfang.
 Lampe. Aluminium. 1 Led. 200 Lumens. Zoom. 3 Modes de Lumière, Fixe et Clignotante. 3 Piles AA Non Incluses.
 Zaklamp. Aluminium. 1 Led. 200 Lumens. Zoom. 3 Licht Posities, Vast en Knipperend. 3 Batterijen AA Niet Inclusief.

📏 Ø 4.2 × 13.7 cm 📦 50 / 25 🗑️ Print Code: E(1), L1





New

Freddie 20194

Torch. Bamboo. 9 Leds. 3 Piles AAA Non Included.
 Lampe. Bambou. 9 Leds. 3 AAA Batterien Nicht im Lieferumfang.
 Lampe. Bambou. 9 Leds. 3 Piles AAA Non Includes.
 Zaklamp. Bamboe. 9 Leds. 3 Batterijen AAA Niet Inclusief.

Ø 3.4 x 10 cm 200 / 100 Print Code: E(4), L1



Sena 20491

Torch. 2 Leds. Hand Charge. Button Batteries Included.
 Lampe. 2 Leds. Dynamo. Knopfzellen Inklusive.
 Lampe. 2 Leds. Chargement Manuel. Piles Bouton Includes.
 Zaklamp. 2 Leds. Hand Oplaadbaar Zaklantaarn. Knopcel Batterijen Inclusief.

5.2 x 10 x 2.8 cm 100 / 50 Print Code: D(4)



Flareon 20984

AL RECYCLED
Aluminium

Torch. Recycled Aluminium. 1 Led. 3 Batteries AAA Not Included.
 Lampe. Recycling Aluminium. 1 Led. 3 AAA Batterien Nicht im Lieferumfang.
 Lampe. Aluminium Recyclé. 1 Led. 3 Piles AAA Non Includes.
 Zaklamp. Gerecycled Aluminium. 1 Led. 3 Batterijen AAA Niet Inclusief.

Ø 2.4 x 8.4 cm 200 / 50 Print Code: D(1), L1

Lumosh 7287

Torch. Aluminium. 9 Leds. 30 Lumens. 3 Batteries AAA Not Included.
 Lampe. Aluminium. 9 Leds. 30 Lumen. 3 AAA Batterien Nicht im Lieferumfang.
 Lampe. Aluminium. 9 Leds. 30 Lumens. 3 Piles AAA Non Includes.
 Zaklamp. Aluminium. 9 Leds. 30 Lumens. 3 Batterijen AAA Niet Inclusief.

Ø 3.2 x 10 cm 100 / 50 Print Code: E(4), L1

Conny 5331

Torch. Aluminium. 9 Leds. 3 Batteries AAA Not Included.
 Lampe. Aluminium. 9 Leds. 3 AAA Batterien Nicht im Lieferumfang.
 Lampe. Aluminium. 9 Leds. 3 Piles AAA Non Includes.
 Zaklamp. Aluminium. 9 Leds. 3 Batterijen AAA Niet Inclusief.

Ø 2.4 x 8.4 cm 200 / 50 Print Code: D(1), L1



New



EXTENSIBLE 57 CM

Eterial 20488

Torch. Aluminium. 1 Led. 4 COB Lights. 3 Light Modes, Fixed and Flashing. Battery 1.200 mAh.

Lampe. Aluminium. 1 Led. 4 COB Lichter. 3 Lichtpositionen, Festes und Blinkendes. Batterie 1.200 mAh.

Lampe. Aluminium. 1 Led. 4 Lumières COB. 3 Modes de Lumière, Fixe et Clignotante. Batterie 1.200 mAh.

Zaklamp. Aluminium. 1 Led. 4 COB Lichten. 3 Licht Posities, Vast en Knipperend. Batterij 1.200 mAh.

📏 Ø 4.5 x 17.4 cm 📦 50 🖨️ Print Code: E(t), L1

Rogla 20490

Torch. 3 Leds. Solar and Hand Charging. Button Batteries Included.

Lampe. 3 Leds. Solarladung und Dynamo. Knopfzellen Inklusive.

Lampe. 3 Leds. Charge Solaire et Manuel. Piles Bouton Inclusief.

Zaklamp. 3 Leds. Zonnelading en Hand Oplaadbaar Zaklantaarn. Knooppcel Batterijen Inclusief.

📏 5 x 9.2 x 3.3 cm 📦 100 / 50 🖨️ Print Code: D(4)

Lachman 20489

Torch. Aluminium. 3 Leds. Extendable and Flexible. Magnetic. Button Batteries Included.

Lampe. Aluminium. 3 Leds. Ausziehbar und Flexibel. Magnetisch. Knopfzellen Inklusive.

Lampe. Aluminium. 3 Leds. Extensible et Flexible. Magnétique. Piles Bouton Inclusief.

Zaklamp. Aluminium. 3 Leds. Verlengbaar en Flexibel. Magnetisch. Knooppcel Batterijen Inclusief.

📏 Ø 2.1 x 17 cm 📦 100 / 50 🖨️ Print Code: E(t), L1



New



Kuruma 20475

Gardening Set. Wood/ Metal. 8 Accessories.
 Gartenset. Holz/ Metall. 8 Teile.
 Ensemble de Jardinage. Bois/ Métal. 8 Accessoires.
 Tuinieren Set. Hou/ Metaal. 8 Accessoires.

49 x 52 cm 10 Print Code: I(8)



Maurix 1116

Gardening Set. Wood/ Metal. 3 Accessories.
 Gartenset. Holz/ Metall. 3 Teile.
 Ensemble de Jardinage. Bois/ Métal. 3 Accessoires.
 Tuinieren Set. Hou/ Metaal. 3 Accessoires.

20 x 18 x 3.5 cm 40 Print Code: G(1), L1, N(8), O



ANTI SLIP

19

08

04

03

Hetson 6500

Gloves. Nylon. One Size. Adult.
 Handschuhe. Nylon. Einheitsgröße. Erwachsene.
 Gant. Nylon. Taille Unique. Adulte.
 Handschoenen. Nylon. Eén Maat. Volwassen.

Consult. 500 / 10 Print Code: N(8)





19 02 04

swisent
ORIZONS
adventure

Klent 7292

Multifunction Pocket Knife, Aluminium/ Stainless Steel. 10 Functions.
Multifunktionstaschenmesser. Aluminium/ Rostfreier Stahl. 10 Funktionen.
Canif Multi-Usages. Aluminium/ Acier Inox. 10 Fonctions.
Multifunctioneel Zakmes. Aluminium/ Roestvrij Staal. 10 Functies.

10.1 x 2.7 x 1.3 cm 100 / 10 Print Code: E(1), L1



Kolmi 3451

Multifunction Pocket Knife, Aluminium/ Stainless Steel. 10 Functions. Polyester Pouch.
Multifunktionstaschenmesser. Aluminium/ Rostfreier Stahl. 10 Funktionen. Polyester Etui.
Canif Multi-Usages. Aluminium/ Acier Inox. 10 Fonctions. Étui Polyester.
Multifunctioneel Zakmes. Aluminium/ Roestvrij Staal. 10 Functies. Polyester Zakje.

9 x 2.5 x 1.5 cm 100 / 10 Print Code: E(4), L1



Shakon 4586

Multifunction Pocket Knife, Stainless Steel. 10 Functions.
Multifunktionstaschenmesser. Rostfreier Stahl. 10 Funktionen.
Canif Multi-Usages. Acier Inox. 10 Fonctions.
Multifunctioneel Zakmes. Roestvrij Staal. 10 Functies.

7.3 x 2.1 x 1.3 cm 100 / 10 Print Code: E(4)



Campello 8225

Multifunction Pocket Knife, Aluminium/ Stainless Steel. 6 Functions.
Multifunktionstaschenmesser. Aluminium/ Rostfreier Stahl. 6 Funktionen.
Canif Multi-Usages. Aluminium/ Acier Inox. 6 Fonctions.
Multifunctioneel Zakmes. Aluminium/ Roestvrij Staal. 6 Functies.

7.2 x 2 x 0.8 cm 240 / 12 Print Code: E(4), L1



03 19



02

SMALL SIZE

Castilla 9855

Mini Multifunction Pocket Knife, Stainless Steel. 6 Functions.
Mini Multifunktionstaschenmesser. Rostfreier Stahl. 6 Funktionen.
Mini-Canif Multi-Usages. Acier Inox. 6 Fonctions.
Mini Multifunctioneel Zakmes. Roestvrij Staal. 6 Functies.

5.8 x 1.8 x 0.8 cm 600 / 20 Print Code: E(4)



Campaña 9562

Pocket Knife. Wood/ Stainless Steel.
Taschenmesser. Holz/ Rostfreier Stahl.
Canif. Bois/ Acier Inox.
Zakmes. Hout/ Roestvrij Staal.

9.4 x 1.6 x 1.6 cm 240 / 12 Print Code: E(4), L1



Dertam 5456

Pocket Knife. Wood/ Stainless Steel. Safety Lock Included.
Taschenmesser. Holz/ Rostfreier Stahl. Sicherheitsverschluss.
Canif. Bois/ Acier Inox. Avec Cran d'Arrêt.
Zakmes. Hout/ Roestvrij Staal. Met Veiligheidsblokkade.

10.1 x 2.9 x 1.4 cm 100 / 10 Print Code: E(4), L1



Woon 8235

Pocket Knife. Wood/ Stainless Steel. Safety Lock Included.
Taschenmesser. Holz/ Rostfreier Stahl. Sicherheitsverschluss.
Canif. Bois/ Acier Inox. Avec Cran d'Arrêt.
Zakmes. Hout/ Roestvrij Staal. Met Veiligheidsblokkade.

9.1 x 2.4 x 1.4 cm 120 / 12 Print Code: E(4), L1



Acer 8232

Pocket Knife. Aluminium/ Stainless Steel. Safety Lock Included.
Taschenmesser. Aluminium/ Rostfreier Stahl. Sicherheitsverschluss.
Canif. Aluminium/ Acier Inox. Avec Cran d'Arrêt.
Zakmes. Aluminium/ Roestvrij Staal. Met Veiligheidsblokkade.

8.7 x 3 x 0.6 cm 240 / 12 Print Code: E(4), L1



Thiam 5457

Pocket Knife. Aluminium/ Stainless Steel. Safety Lock Included.
Taschenmesser. Aluminium/ Rostfreier Stahl. Sicherheitsverschluss.
Canif. Aluminium/ Acier Inox. Avec Cran d'Arrêt.
Zakmes. Aluminium/ Roestvrij Staal. Met Veiligheidsblokkade.

8.9 x 2.6 x 1.2 cm 100 / 10 Print Code: E(4), L1



23 Special **AGRICULTURE**





New

Sparq 21232

Corkscrew Pocket Knife. Wood/ Stainless Steel.
Korkenzieher Taschenmesser. Holz/ Rostfreier Stahl.
Canif Tire-Bouchon. Bois/ Acier Inox.
Kurkretrekker Zakmes. Hout/ Roestvrij Staal.

11.8 x 2.4 x 1.5 cm 120 / 12
Print Code: E(4), L1



New

Rinex 21233

Pocket Knife. Wood/ Stainless Steel.
Taschenmesser. Holz/ Rostfreier Stahl.
Canif. Bois/ Acier Inox.
Zakmes. Hout/ Roestvrij Staal.

10.8 x 2.1 x 1.5 cm 120 / 12
Print Code: E(4), L1



New

Terral 21229

Pocket Knife. Wood/ Stainless Steel. Safety Lock Included.
Taschenmesser. Holz/ Rostfreier Stahl. Sicherheitsverschluss.
Canif. Bois/ Acier Inox. Avec Cran d'Arrêt.
Zakmes. Hout/ Roestvrij Staal. Met Veiligheidsblokkade.

10.9 x 2.4 x 2.1 cm 240 / 12
Print Code: E(4), L1



New

Koburn 20994

Pocket Knife. Aluminium/ Stainless Steel.
Taschenmesser. Aluminium/ Rostfreier Stahl.
Canif. Aluminium/ Acier Inox.
Zakmes. Aluminium/ Roestvrij Staal.

2.3 x 7.5 x 0.7 cm 200 / 50
Print Code: D(1), L1, V



New

Spiet 21010

Pocket Knife Keyring. Stainless Steel/ Wood.
Taschenmesser Schlüsselanhänger. Rostfreier Stahl/ Holz.
Porte-Clés Canif. Acier Inox/ Bois.
Zakmes Sleutelhanger. Roestvrij Staal/ Hout.

1.8 x 8 x 1 cm 200 / 50
Print Code: L1



New

Famke 21009

Multitool Keyring. Wood/ Stainless Steel. 3 Functions.
Multiwerkzeug Schlüsselanhänger. Holz/ Rostfreier Stahl. 3 Funktionen.
Porte-Clés Multi Outils. Bois/ Acier Inox. 3 Fonctions.
Multitool Sleutelhanger. Hout/ Roestvrij Staal. 3 Functies.

6.1 x 2 x 1 cm 200 / 50
Print Code: D(1), L1

New



Hokem 21227

Pocket Knife. Wood/ Stainless Steel. Safety Lock Included.
Taschenmesser. Holz/ Rostfreier Stahl. Sicherheitsverschluss.
Canif. Bois/ Acier Inox. Avec Cran d'Arrêt.
Zakmes. Hout/ Roestvrij Staal. Met Veiligheidsblokkade.

10.9 x 2.4 x 2.1 cm 240 / 12 Print Code: E(4), L1

New



04 02 19

Xiflon 21228

Pocket Knife. Wood/ Stainless Steel. Safety Lock Included.
Taschenmesser. Holz/ Rostfreier Stahl. Sicherheitsverschluss.
Canif. Bois/ Acier Inox. Avec Cran d'Arrêt.
Zakmes. Hout/ Roestvrij Staal. Met Veiligheidsblokkade.

10.9 x 2.4 x 2.1 cm 240 / 12 Print Code: E(4), L1



03

New



Mulsen 21230

Pocket Knife. Stainless Steel.
Taschenmesser. Rostfreier Stahl.
Canif. Acier Inox.
Zakmes. Roestvrij Staal.

10 x 3.3 x 1.1 cm 240 / 12 Print Code: E(4)

New



19 03 02

Youks 21231

Pocket Knife. Stainless Steel.
Taschenmesser. Rostfreier Stahl.
Canif. Acier Inox.
Zakmes. Roestvrij Staal.

10 x 3.3 x 1.1 cm 240 / 12 Print Code: E(4)



04

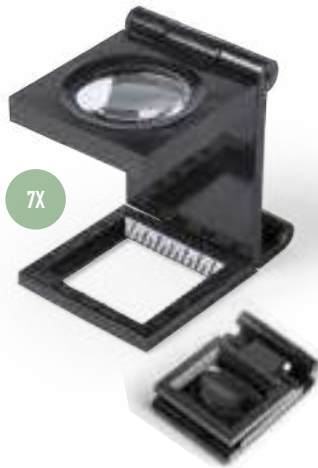

Mauran 7X 8530

Magnifier. With Ruler for Measurement.
Lupe. Mit Messlineal.
Loupe Compte-Fils. Avec Règle de Mesure.
Vergrootglas. Lijnaal met Maat Verdeling.

3 x 4.5 x 4.6 cm 600 / 200 Print Code: C(4)



Tudels 8X 21251

Magnifier. 1 Led. With Ruler for Measurement. Button Batteries Included.
Lupe. 1 Led. Mit Messlineal. Knopfzellen Inklusive.
Loupe Compte-Fils. 1 Led. Avec Règle de Mesure. Piles Bouton Incluses.
Vergrootglas. 1 Led. Lijnaal met Maat Verdeling. Knoopcel Batterijen Inclusief.

5.3 x 5.5 x 4.2 cm 500 / 50 Print Code: C(4)

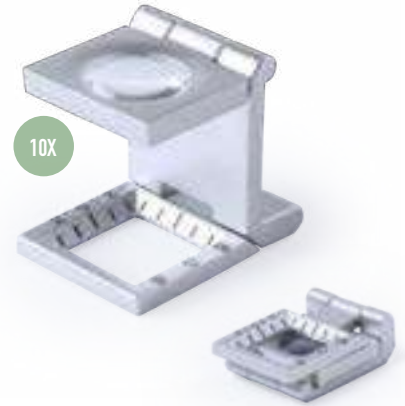

Court 10X 9521

Magnifier. Metal. With Ruler for Measurement.
Lupe. Metall. Mit Messlineal.
Loupe Compte-Fils. Métal. Avec Règle de Mesure.
Vergrootglas. Metaal. Lijnaal met Maat Verdeling.

2.3 x 2.5 x 3 cm 200 / 50 Print Code: E(4), L1



Rindex 20X 21250

Magnifier. Metal.
Lupe. Metall.
Loupe. Métal.
Vergrootglas. Metaal.

3.5 x 1.8 x 2.5 cm 200 / 50 Print Code: D(1), L1



Yoplin 30X 21252

Magnifier. Metal. 2 Leds. Button Batteries Included.
Lupe. Metall. 2 Leds. Knopfzellen Inklusive.
Loupe. Métal. 2 Leds. Piles Bouton Incluses.
Vergrootglas. Metaal. 2 Leds. Knoopcel Batterijen Inclusief.

5.3 x 2.1 x 2.8 cm 100 / 50 Print Code: D(1), L1



Nalix 10/20X 21249

Magnifier. Metal.
Lupe. Metall.
Loupe. Métal.
Vergrootglas. Metaal.

5.3 x 1.8 x 2.1 cm 200 / 50 Print Code: D(1), L1



Kitins 8X 21257

Magnifier Keyring. Metal.
Lupe Schlüsselanhänger. Metall.
Loupe Porte-Clés. Métal.
Vergrootglas Sleutelhanger. Metaal.

3 × 4.4 × 0.8 cm 300 / 50
Print Code: D(1), L1



Keyan 30/60X 21254

Magnifier. Metal. 2 Leds. Button Batteries Included.
Lupe. Metall. 2 Leds. Knopfzellen Inklusive.
Loupe. Métal. 2 Leds. Piles Bouton Incluses.
Vergrootglas. Metaal. 2 Leds. Knoopcel Batterijen Inclusief.

5.3 × 2.8 × 3.4 cm 100 / 50
Print Code: D(1)



Nunky 30X 21253

Magnifier. Metal. 2 Leds. Button Batteries Included.
Lupe. Metall. 2 Leds. Knopfzellen Inklusive.
Loupe. Métal. 2 Leds. Piles Bouton Incluses.
Vergrootglas. Metaal. 2 Leds. Knoopcel Batterijen Inclusief.

5.7 × 2.5 × 3.4 cm 200 / 50
Print Code: D(1)



Kondes 20X 21256

Magnifier Keyring. 1 Led. Button Batteries Included.
Lupe Schlüsselanhänger. 1 Led. Knopfzellen Inklusive.
Loupe Porte-Clés. 1 Led. Piles Bouton Incluses.
Vergrootglas Sleutelhanger. 1 Led. Knoopcel Batterijen Inclusief.

3.5 × 5.4 × 2.4 cm 300 / 50
Print Code: C(4)



Dicson 60X 5134

Microscope. ABS/ Metal. 2 Leds. Ultraviolet Light. Button Batteries Included. Polyester Pouch.
Mikroskoop. ABS/ Metall. 2 Leds. Ultraviolettes Licht. Knopfzellen Inklusive. Polyester Etui.
Microscope. ABS/ Métal. 2 Leds. Ultraviolets. Piles Bouton Incluses. Étui Polyester.
Microscop. ABS/ Metaal. 2 Leds. Ultraviolet Licht. Knoopcel Batterijen Inclusief. Polyester Zakje.

7 × 8 × 2.2 cm 300 / 100
Print Code: D(4)



Saganix 60X 21255

Microscope. 1 Led. Ultraviolet Light. Polyester Pouch. Button Batteries Included.
Mikroskoop. 1 Led. Ultraviolettes Licht. Polyester Etui. Knopfzellen Inklusive.
Microscope. 1 Led. Ultraviolets. Étui Polyester. Piles Bouton Incluses.
Microscop. 1 Led. Ultraviolet Licht. Polyester Zakje. Knoopcel Batterijen Inclusief.

4 × 6 × 2.1 cm 300 / 50
Print Code: D(4), N(8)



New

70 ml

Roswal 2744

Measuring Cup, PP, 70 ml.
 Messbecher, PP, 70 ml.
 Verre Mesureur, PP, 70 ml.
 Maatbeker, PP, 70 ml.

📏 Ø 6.2 x 5.3 cm 📦 750 🖨️ Print Code: B(1)



New

250 ml

Felix 2743

Measuring Cup, PP, 250 ml.
 Messbecher, PP, 250 ml.
 Verre Mesureur, PP, 250 ml.
 Maatbeker, PP, 250 ml.

📏 Ø 6.7 x 10.3 cm 📦 600 🖨️ Print Code: C(1)



New

Finak 2748

Shovel, PP.
 Schaufel, PP.
 Pelle, PP.
 Schep, PP.

📏 23 x 4.5 x 8.8 cm 📦 180 🖨️ Print Code: B(1)



New

6 L

Manson 2740

Measuring Bucket, PP, 6 L.
 Messeimer, PP, 6 L.
 Seau Mesureur, PP, 6 L.
 Maatemmer, PP, 6 L.

📏 Ø 26.5 x 22.5 cm 📦 50 🖨️ Print Code: F(1)



New

12 L

Lunux 2741

Measuring Bucket, PP, 12 L.
 Messeimer, PP, 12 L.
 Seau Mesureur, PP, 12 L.
 Maatemmer, PP, 12 L.

📏 Ø 29 x 25 cm 📦 20 🖨️ Print Code: F(1)



Ladex 21245

Measuring Jug, PP, 500 ml.
Messkrug, PP, 500 ml.
Carafe Mesureur, PP, 500 ml.
Maatkan, PP, 500 ml.

📏 Ø 9.5 × 12.5 cm 📦 200 🗑️ Print Code: D(1)

Suwan 2745

Measuring Jug, PP, 1 L.
Messkrug, PP, 1 L.
Carafe Mesureur, PP, 1 L.
Maatkan, PP, 1 L.

📏 Ø 13.5 × 13.5 cm 📦 150 🗑️ Print Code: D(1)

Lumer 2742

Measuring Jug, PP, 1 L.
Messkrug, PP, 1 L.
Carafe Mesureur, PP, 1 L.
Maatkan, PP, 1 L.

📏 20 × 11.5 × 11 cm 📦 150 🗑️ Print Code: D(1)



Sasuk 2746

Measuring Jug, PP, 2.2 L.
Messkrug, PP, 2.2 L.
Carafe Mesureur, PP, 2.2 L.
Maatkan, PP, 2.2 L.

📏 Ø 10 × 22.2 cm 📦 60 🗑️ Print Code: E(1)



Danlox 21244

Measuring Jug, PP, 4 L.
Messkrug, PP, 4 L.
Carafe Mesureur, PP, 4 L.
Maatkan, PP, 4 L.

📏 Ø 17.7 × 25.2 cm 📦 40 🗑️ Print Code: E(1)



New

Langek 21234

Weighing Scales. 2 Accessories 50 ml and 25 ml. Max 300 g. Button Battery Included.

Waage. 2 Teile 50 ml und 25 ml. Max 300 g. Knopfzelle Inklusiv.

Balance. 2 Accessoires 50 ml et 25 ml. Max 300 g. Pile Bouton Inclusive.

Weegschaal. 2 Accessoires 50 ml en 25 ml. Max 300 g. Knopcel Batterij Inclusief.

6.2 x 24.5 x 3 cm 50 Print Code: E(4)



New

1 L

Plazix 21235

Measuring Scale. PP/ ABS. 1 L. Max 5 Kg. Button Battery Included.

Messwaage. PP/ ABS. 1 L. Max 5 Kg. Knopfzelle Inklusiv.

Balance Mesureuse. PP/ ABS. 1 L. Max 5 Kg. Pile Bouton Inclusive.

Maatweegschaal. PP/ ABS. 1 L. Max 5 Kg. Knopcel Batterij Inclusief.

21 x 15 x 14.5 cm 12 Print Code: F(1)



Niben 21236

Weighing Scales. Max 50 Kg. 2 Batteries AAA Not Included.

Waage. Max 50 Kg. 2 AAA Batterien Nicht im Lieferumfang.

Balance. Max 50 Kg. 2 Piles AAA Non Inclusive.

Weegschaal. Max 50 Kg. 2 Batterijen AAA Niet Inclusief.

14.4 x 12 x 1.5 cm 50 Print Code: E(1)



New



New

Dreax 21238

Thermometer. 2 Batteries AAA Not Included.

Thermometer. 2 AAA Batterien Nicht im Lieferumfang.

Thermomètre. 2 Piles AAA Non Inclusive.

Thermometer. 2 Batterijen AAA Niet Inclusief.

8 x 13.3 x 3 cm 100 / 50 Print Code: D(4)



Jarris 21237

Thermometer. 1 Battery AAA Not Included.

Thermometer. 1 AAA Batterie Nicht im Lieferumfang.

Thermomètre. 1 Pile AAA Non Inclusive.

Thermometer. 1 Batterij AAA Niet Inclusief.

3 x 17 x 2.7 cm 100 / 50 Print Code: D(1)



New





40 L/ m2 2050

Rain Meter. Scale Measurement: 1 Line = 1 L/ m2.
Niederschlagsmesser. Messbereich: 1 Strich = 1 L/ m2.
Pluviomètre. Graduation: 1 Trait = 1 L/ m2.
Regenmeter. Schaal: 1 Lijn = 1 L/ m2.

📏 Ø 8 × 44 cm 📦 200 🖨️ Print Code: D(1)

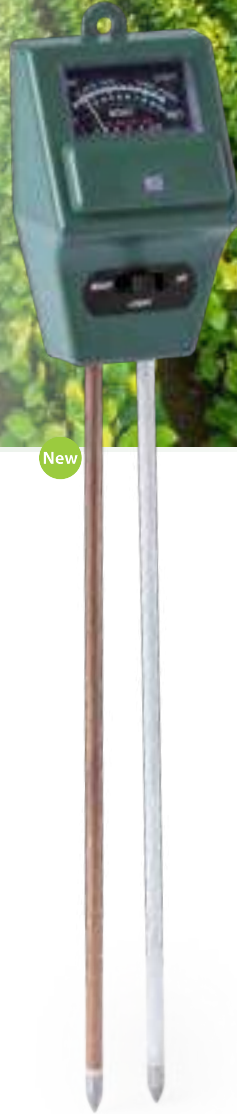

Pyrom 21240

Combitester. 3 Functions. Hygrometer, Luxmeter, and Phmeter.
Erdtester. 3 Funktionen. Hygrometer, Luxmeter und Phmeter.
Testeur de Terre. 3 Fonctions. Hygromètre, Luxmètre et Phmètre.
Aardetester. 3 Functies. Hygrometer, Luxmeter en Phmeter.

📏 5.8 × 29.5 × 3.7 cm 📦 50 🖨️ Print Code: E(1)



Cynex 21239

Soil Thermometer.
Bodenthermometer.
Thermomètre Cuisine.
Grondthermometer.

📏 2.8 × 32 × 2.1 cm 📦 100 🖨️ Print Code: E(1)



New

Balest 21243

Anemometer. Button Battery Included.
Anemometer. Knopfzelle Inklusiv.
Anémomètre. Pile Bouton Inclus.
Anemometer. Knoopcel Batterij Inclusief.

4.4 x 11 x 2.2 cm 50 Print Code: E(1)



New

Jekux 21242

Refractometer.
Refraktometer.
Réfractomètre.
Refractometer.

21 x 6 x 9 cm 25 Print Code: F(1), L2



New

Sheley 21241

Caliper. Button Battery Included.
Messschieber. Knopfzelle Inklusiv.
Calibre. Pile Bouton Inclus.
Schuifmaat. Knoopcel Batterij Inclusief.

7.8 x 24 x 1.5 cm 100 Print Code: E(1)



Miant 2739

Caliper. PP. 13 Accessories. 30-90 mm.
Kalibrator. PP. 13 Teile. 30-90 mm.
Calibreur. PP. 13 Accessoires. 30-90 mm.
Kalibrator. PP. 13 Accessoires. 30-90 mm.

11 x 16.5 x 1.4 cm 100 Print Code: C(1)



New

New

Iswud 2738

Caliper. PP. 8 Accessories. 14-28 mm.
Kalibrator. PP. 8 Teile. 14-28 mm.
Calibreur. PP. 8 Accessoires. 14-28 mm.
Kalibrator. PP. 8 Accessoires. 14-28 mm.

4.4 x 8.6 x 0.9 cm 250 Print Code: C(1)



Lautar 1964



Weather Station. Indoor/ Outdoor Temperature Sensor. USB Connection Adapter.
 Wetterstation. Äußere und Innentemperatur Sensor. USB Anschluss Adapter.
 Station Météo. Température Intérieur/ Extérieur. Adaptateur Connexion USB.
 Weerstation. Binnen Buiten Temperatuur Sensor. USB Verbinding Adapter.

18.1 x 11.9 x 2 cm 20 / 10 Print Code: E(1), W



New



Maginly 21022



Weather Station. Wheat Straw/ ABS. 2 Batteries AAA Not Included.
 Wetterstation. Weizenstroh/ ABS. 2 AAA Batterien Nicht im Lieferumfang.
 Station Météo. Paille de Blé/ ABS. 2 Piles AAA Non Incluses.
 Weerstation. Tarwestro/ ABS. 2 Batterijen AAA Niet Inclusief.

8 x 14.2 x 4 cm 50 / 25 Print Code: E(4)



New



Geibol 21021

Weather Station. 2 Batteries AAA Not Included.
 Wetterstation. 2 AAA Batterien Nicht im Lieferumfang.
 Station Météo. 2 Piles AAA Non Incluses.
 Weerstation. 2 Batterijen AAA Niet Inclusief.

6.7 x 14.3 x 5.5 cm 50 / 25 Print Code: E(4)



Behox 6806

Weather Station. Bamboo/ ABS. 2 Batteries AAA Not Included.
 Wetterstation. Bambus/ ABS. 2 AAA Batterien Nicht im Lieferumfang.
 Station Météo. Bambou/ ABS. 2 Piles AAA Non Incluses.
 Weerstation. Bamboe/ ABS. 2 Batterijen AAA Niet Inclusief.

13 x 13 x 2.4 cm 50 / 25 Print Code: E(4), L2, W



BAMBOO

24 HEADWARE







New

13



Pepper 21168

Hat. 100% Cotton.
Hut. 100% Baumwolle.
Bonnet. 100% Coton.
Muts. 100% Katoen.



ADJUSTABLE INNER BAND

Consult. 200 / 20 Print Code: F(1), N(8), O, P

RECYCLED COTTON



08



NEW COLOR

Madelyn 1539

Hat. 100% Recycled Cotton.
Hut. 100% Recycling Baumwolle.
Bonnet. 100% Coton Recyclé.
Muts. 100% Gerecycled Katoen.

Consult. 200 / 50 Print Code: F(1), N(8), O, P



06



NEW COLOR

Marvin 8538

Hat. 100% Cotton.
Hut. 100% Baumwolle.
Bonnet. 100% Coton.
Muts. 100% Katoen.

Consult. 200 / 50 Print Code: F(1), N(8), O, P



New

06

FOLDABLE

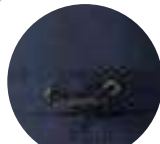

ADJUSTABLE

Hetoson 21165

Hat. Microfibre. Foldable.
Hut. Mikrofaser. Faltbar.
Bonnet. Microfibre. Pliable.
Muts. Microfibre. Opvouwbaar.

Consult. 200 / 20 Print Code: F(1), G(1), H(1)



04

Safari 9335

Hat. 100% Cotton.
Hut. 100% Baumwolle.
Bonnet. 100% Coton.
Muts. 100% Katoen.

Consult. 200 / 50 Print Code: F(1), N(8), O, P



14



New

03



18

08

06

02

Sirocon 20841

Hat, 100% Cotton.
Hut, 100% Baumwolle.
Bonnet, 100% Coton.
Muts, 100% Katoen.

Consult. 200 / 50 Print Code: F(1), N(8), O, P



Stone
Washing



02

03

06

08

Bongs 20840

Cap, 100% Cotton, 6 Panels, Buckle Closure.
Mütze, 100% Baumwolle, 6 Panels, Schnallen Verschluss.
Casquette, 100% Coton, 6 Panneaux, Fermeture à Boucle.
Pet, 100% Katoen, 6 Panelen, Gesp Stuiting.

Consult. 200 / 25 Print Code: F(1), N(8), O, P



New

18

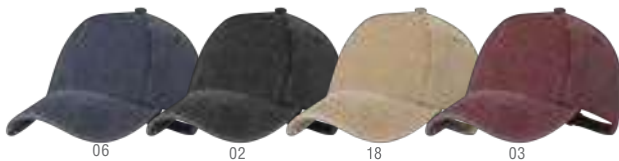

06

02

18

03

Zorp 20839

Cap, 100% Cotton, 5 Panels, Buckle Closure.
Mütze, 100% Baumwolle, 5 Panels, Schnallen Verschluss.
Casquette, 100% Coton, 5 Panneaux, Fermeture à Boucle.
Pet, 100% Katoen, 5 Panelen, Gesp Stuiting.

Consult. 200 / 25 Print Code: F(1), N(8), O, P



New

08

New



02



Oconor 20835

Cap. Polyester RPET. 6 Panels. Velcro Closure.
 Mütze. Polyester RPET. 6 Panels. Klett Verschluss.
 Casquette. Polyester RPET. 6 Panneaux. Fermeture Velcro.
 Pet. Polyester RPET. 6 Panelen. Klittenband Stuiting.

Consult. 200 / 25 Print Code: F(1), N(8), O, P, R



New



03



Sandrok 20836

Cap. Polyester RPET. 5 Panels. Velcro Closure.
 Mütze. Polyester RPET. 5 Panels. Klett Verschluss.
 Casquette. Polyester RPET. 5 Panneaux. Fermeture Velcro.
 Pet. Polyester RPET. 6 Panelen. Klittenband Stuiting.

Consult. 200 / 25 Print Code: F(1), N(8), O, P, R



19



Keinfax 6420

Cap. Polyester RPET. 5 Panels. Velcro Closure.
 Mütze. Polyester RPET. 5 Panels. Klett Verschluss.
 Casquette. Polyester RPET. 5 Panneaux. Fermeture Velcro.
 Pet. Polyester RPET. 5 Panelen. Klittenband Stuiting.

Consult. 300 / 30 Print Code: F(1), N(8), O, P, R



RECYCLED COTTON



New



13

New



08



19 06 08 04 01 02 03

Brauner 20837

Cap. 100% Recycled Cotton. 5 Panels. Buckle Closure.
Mütze. 100% Recycling Baumwolle. 5 Panels. Schnallen Verschluss.
Casquette. 100% Coton Recyclé. 5 Panneaux. Fermeture à Boucle.
Pet. 100% Gerecycled Katoen. 5 Panelen. Gesp Stuiting.

Consult. 200 / 25 Print Code: F(1), N(8), O, P



19 06 04 03 02 01 13

Daimat 20838

Cap. 100% Recycled Cotton. 6 Panels. Buckle Closure.
Mütze. 100% Recycling Baumwolle. 6 Panels. Schnallen Verschluss.
Casquette. 100% Coton Recyclé. 6 Panneaux. Fermeture à Boucle.
Pet. 100% Gerecycled Katoen. 6 Panelen. Gesp Stuiting.

Consult. 200 / 25 Print Code: F(1), N(8), O, P



Organic
Cotton**Zonner 6421**

Cap. 100% Organic Cotton. 5 Panels. Velcro Closure.
Mütze. 100% Organische Baumwolle. 5 Panneaux. Klett Verschluss.
Casquette. 100% Coton Organique. 5 Panneaux. Fermeture Velcro.
Pet. 100% Organisch Katoen. 5 Panelen. Klittenband Stuiting.

Consult. 300 / 30 Print Code: F(1), N(8), O, P

**Vachir 1033**

Cap. 100% Organic Cotton/ Cork. 5 Panels. Velcro Closure.
Mütze. 100% Organische Baumwolle/ Kork. 5 Panneaux. Klett Verschluss.
Casquette. 100% Coton Organique/ Liège. 5 Panneaux. Fermeture Velcro.
Pet. 100% Organisch Katoen/ Kurk. 5 Panelen. Klittenband Stuiting.

Consult. 200 / 50 Print Code: F(1), N(8), O, P



New



RPET

Daphne 20832

Cap. Polyester RPET. 5 Panels. Plastic Closure.
Mütze. Polyester RPET. 5 Panneaux. Plastik Verschluss.
Casquette. Polyester RPET. 5 Panneaux. Fermeture Plastique.
Pet. Polyester RPET. 5 Panelen. Kunststof Stuiting.

Consult. 200 / 25 Print Code: N(8)



100% CANVAS

Trystan 1538

Cap. 100% Canvas. 5 Panels. Buckle Closure.
Mütze. 100% Segeltuch. 5 Panneaux. Schnallen Verschluss.
Casquette. 100% Toile. 5 Panneaux. Fermeture à Boucle.
Pet. 100% Canvas. 5 Panelen. Gesp Stuiting.

Consult. 200 / 50 Print Code: F(1), N(8), O, P



ORGANIC COTTON



New

New



13



06



03 19 08 04 02 01 06



03 19 08 04 02 01 13 06

Calipso 20834

Cap. 100% Organic Cotton. 6 Panels. Buckle Closure.
 Mütze. 100% Organische Baumwolle. 6 Panels. Schnallen Verschluss.
 Casquette. 100% Coton Organique. 6 Panneaux. Fermeture à Boucle.
 Pet. 100% Organisch Katoen. 6 Panelen. Gesp Stuiting.

Consult. 200 / 25 Print Code: F(1), N(8), O, P



Gleyre 20833

Cap. 100% Organic Cotton. 5 Panels. Buckle Closure.
 Mütze. 100% Organische Baumwolle. 5 Panels. Schnallen Verschluss.
 Casquette. 100% Organic Cotton. 5 Panneaux. Fermeture à Boucle.
 Pet. 100% Organisch Katoen. 5 Panelen. Gesp Stuiting.

Consult. 200 / 25 Print Code: F(1), N(8), O, P



Bayon 4901

Cap. 100% Brushed Cotton. 5 Panels. Velcro Closure.
Mütze. 100% Gebürstete Baumwolle. 5 Panels. Klett Verschluss.
Casquette. 100% Coton Peigné. 5 Panneaux. Fermeture Velcro.
Pet. 100% Geborsteld Katoen. 5 Panelen. Klittenband Stuiting.

 Consult.  200 / 50  Print Code: F(1), N(8), O, P

**Kisse 4676**

Cap. 100% Brushed Cotton. 5 Panels. Velcro Closure.
Mütze. 100% Gebürstete Baumwolle. 5 Panels. Klett Verschluss.
Casquette. 100% Coton Peigné. 5 Panneaux. Fermeture Velcro.
Pet. 100% Geborsteld Katoen. 5 Panelen. Klittenband Stuiting.

 Consult.  200 / 50  Print Code: N(8), O, P

**Rittel 4902**

Cap. 100% Brushed Cotton. 6 Panels. Velcro Closure.
Mütze. 100% Gebürstete Baumwolle. 6 Panels. Klett Verschluss.
Casquette. 100% Coton Peigné. 6 Panneaux. Fermeture Velcro.
Pet. 100% Geborsteld Katoen. 6 Panelen. Klittenband Stuiting.

 Consult.  200 / 50  Print Code: F(1), N(8), O, P

**Rubec 4675**

Cap. 100% Brushed Cotton. 6 Panels. Velcro Closure.
Mütze. 100% Gebürstete Baumwolle. 6 Panels. Klett Verschluss.
Casquette. 100% Coton Peigné. 6 Panneaux. Fermeture Velcro.
Pet. 100% Geborsteld Katoen. 6 Panelen. Klittenband Stuiting.

 Consult.  200 / 50  Print Code: F(1), N(8), O, P





13



08



Mimax 20830

Cap. 100% Brushed Cotton. 5 Panels. Buckle Closure.
Mütze. 100% Gebürstete Baumwolle. 5 Panels. Schnallen Verschluss.
Casquette. 100% Coton Peigné. 5 Panneaux. Fermeture à Boucle.
Pet. 100% Geborsteld Katoen. 5 Panelen. Gesp Stuitling.

Consult. 200 / 25 Print Code: F(1), N(8), O, P



Linnea 1535

Cap. 100% Brushed Cotton. 6 Panels. Buckle Closure.
Mütze. 100% Gebürstete Baumwolle. 6 Panels. Schnallen Verschluss.
Casquette. 100% Coton Peigné. 6 Panneaux. Fermeture à Boucle.
Pet. 100% Geborsteld Katoen. 6 Panelen. Gesp Stuitling.

Consult. 200 / 50 Print Code: F(1), N(8), O, P



19



06



Karola 20829

Cap. Microfibre. 5 Panels. Buckle Closure.
Mütze. Mikrofaser. 5 Panels. Schnallen Verschluss.
Casquette. Microfibre. 5 Panneaux. Fermeture à Boucle.
Pet. Microfibre. 5 Panelen. Gesp Stuitling.

Consult. 200 / 25 Print Code: F(1), N(8), O, P, R



Klarke 1533

Cap. Brushed Cotton/ Spandex. 6 Panels. Regolabile Elastica.
Mütze. Gebürstete Baumwolle/ Spandex. 6 Panels. Elastischer Verstellbar.
Casquette. Coton Peigné/ Spandex. 6 Panneaux. Elastic Adjustable.
Pet. Geborsteld Katoen/ Spandex. 6 Panelen. Ajustável Elástico.

S-M, L, XL 100 / 25 Print Code: F(1), N(8), O, P





Zodak 4828

Cap. Polyester. 5 Panels. Plastic Closure.
Mütze. Polyester. 5 Panels. Plastik Verschluss.
Casquette. Polyester. 5 Panneaux. Fermeture Plastique.
Pet. Polyester. 5 Panelen. Kunststof Sluiting.

Consult. 200 / 25 Print Code: F(1), N(8), O, P



SUBLIMATION

01



04

05

07

02

03

19

Clipak 6337

Cap. Polyester. 5 Panels. Plastic Closure.
Mütze. Polyester. 5 Panels. Plastik Verschluss.
Casquette. Polyester. 5 Panneaux. Fermeture Plastique.
Pet. Polyester. 5 Panelen. Kunststof Sluiting.

Consult. 200 / 25 Print Code: F(1), N(8), O, P, R



SPECIAL PRINTING

02



06



08

06



02



01

Flecher 1537



SUBLIMATION

Cap. Cotton/ Polyester. 5 Panels. Plastic Closure.
Mütze. Baumwolle/ Polyester. 5 Panels. Plastik Verschluss.
Casquette. Coton/ Polyester. 5 Panneaux. Fermeture Plastique.
Pet. Katoen/ Polyester. 5 Panelen. Kunststof Sluiting.

Consult. 200 / 50 Print Code: N(8), O, R

Danix 6618

Cap. Polyester. 6 Panels. Plastic Closure.
Mütze. Polyester. 6 Panels. Plastik Verschluss.
Casquette. Polyester. 6 Panneaux. Fermeture Plastique.
Pet. Polyester. 6 Panelen. Kunststof Sluiting.

Consult. 200 / 50 Print Code: F(1), N(8), O, P



06



Sport 8072

Cap. 100% Cotton. 5 Panels. Velcro Closure.
 Mütze. 100% Baumwolle. 5 Panels. Klett Verschluss.
 Casquette. 100% Coton. 5 Panneaux. Fermeture Velcro.
 Pet. 100% Katoen. 5 Panelen. Klittenband Stuiting.

Consult. 300 / 30 Print Code: F(1), N(8), O, P



04



Haliard 20831

Cap. 100% Cotton. 6 Panels. Velcro Closure.
 Mütze. 100% Baumwolle. 6 Panels. Klett Verschluss.
 Casquette. 100% Coton. 6 Panneaux. Fermeture Velcro.
 Pet. 100% Katoen. 6 Panelen. Klittenband Stuiting.

Consult. 200 / 25 Print Code: F(1), N(8), O, P

Microfibre & Polyester



02



Blazok 5226



Cap. Microfibre/ Polyester. 6 Panels. Velcro Closure.
 Mütze. Mikrofaser/ Polyester. 6 Panels. Klett Verschluss.
 Casquette. Microfibre/ Polyester. 6 Panneaux. Fermeture Velcro.
 Pet. Microfibre/ Polyester. 6 Panelen. Klittenband Stuiting.

Consult. 300 / 50 Print Code: F(1), N(8), O, P, R



03



Krox 5225



Cap. Microfibre/ Polyester. 5 Panels. Velcro Closure.
 Mütze. Mikrofaser/ Polyester. 5 Panels. Klett Verschluss.
 Casquette. Microfibre/ Polyester. 5 Panneaux. Fermeture Velcro.
 Pet. Microfibre/ Polyester. 5 Panelen. Klittenband Stuiting.

Consult. 300 / 50 Print Code: F(1), N(8), O, P, R



19



05 04 03 11 07 02 01

Sodel 4479



Cap. Polyester. 5 Panels. Velcro Closure.
 Mütze. Polyester. 5 Panels. Klettverschluss.
 Casquette. Polyester. 5 Panneaux. Fermeture Velcro.
 Pet. Polyester. 5 Panelen. Klittenband Stuiting.

Consult. 200 / 25 Print Code: F(1), N(8), O, P, R



02



01 04 05 03 11 19

Yobs 5360

Cap. Polyester. 5 Panels. Plastic Closure.
 Mütze. Polyester. 5 Panels. Plastik Verschluss.
 Casquette. Polyester. 5 Panneaux. Fermeture Plastique.
 Pet. Polyester. 5 Panelen. Kunststoff Stuiting.

Consult. 200 / 25 Print Code: F(1), N(8), O, P, R



03



19 01 02

Lorenz 3945

Cap. Cotton/ Thick Polyester. 5 Panels. Velcro Closure.
 Mütze. Baumwolle/ Groß Polyester. 5 Panels. Klettverschluss.
 Casquette. Coton/ Polyester Épais. 5 Panneaux. Fermeture Velcro.
 Pet. Katoen/ Dikke Polyester. 5 Panelen. Klittenband Stuiting.

Consult. 200 / 50 Print Code: F(1), N(8), O, P, R



14



04



02

Saigón 9678

Cap. 100% Brushed Cotton. Velcro Closure.
Mütze. 100% Gebürstete Baumwolle. Klett Verschluss.
Casquette. 100% Coton Peigné. Fermeture Velcro.
Pet. 100% Geborsteld Katoen. Klittenband Stuiting.

Consult. 300 / 50 Print Code: F(1), N(8), O, P



New



18



02



08



14



06

Bruck 20157

Cap. 100% Cotton. Velcro Closure.
Mütze. 100% Baumwolle. Klett Verschluss.
Casquette. 100% Coton. Fermeture Velcro.
Pet. 100% Katoen. Klittenband Stuiting.

Consult. 200 / 25 Print Code: F(1), N(8), O, P



New



371



372

Prody 20155

Cap. Thick Polyester. Buckle Closure.
Mütze. Groß Polyester. Schnallen Verschluss.
Casquette. Polyester Épais. Fermeture à Boucle.
Pet. Dikke Polyester. Gesp Stuiting.

Consult. 100 / 25 Print Code: N(8), O, P



06



02



19



20



03



04



13

Nesy 9066

Reversible Hat. Outside: Nylon. Inside: Polar Fleece. Anti-Pilling.
Wendehut. Äußere: Nylon. Innen: Polar Fleece. Anti-Pilling.
Bonnet Réversible. Extérieur: Nylon. Intérieur: Polaire. Anti-Pilling.
Omkeerbare Muts. Buitenzijde: Nylon. Binnenzijde: Polar Fleece. Anti-Pilling.

Consult. 200 / 50 Print Code: F(1), N(8), O



REVERSIBLE



03



19

Gonnax 4900

Sun Visor. Polyester.
Sonnenblende. Polyester.
Visière. Polyester.
Zonneklep. Polyester.

Consult. 250 / 25
Print Code: F(1), N(8), O, P, R



Tiger 3330

Sun Visor. 100% Cotton.
Sonnenblende. 100% Baumwolle.
Visière. 100% Coton.
Zonneklep. 100% Katoen.

Consult. 250 / 25
Print Code: F(1), N(8), O, P



03



04



Arilyn 20505

Headband. Polyester.
Stirnband. Polyester.
Bandeau Tête. Polyester.
Hoofdband. Polyester.

22.5 x 8 cm 300 / 10
Print Code: E(1), N(8), R

Narim 6358

Sun Visor. PVC. UV Protection.
Sonnenblende. PVC. UV Schutz.
Visière. PVC. Protection UV.
Zonneklep. PVC. UV Bescherming.

Consult. 200 / 10
Print Code: E(1)



01



Isildur 1536

Cap. Microfibre. Reflective. Velcro Closure.
 Mütze. Mikrofaser. Reflektierender. Klett Verschluss.
 Casquette. Microfibre. Réfléchissant. Fermeture Velcro.
 Pet. Microfiber. Reflectorend. Klittenband Stütting.

Consult. 300 / 30 Print Code: F(1), N(8), O, P, R



05



Laimbur 5565

Cap. Microfibre. Elastic Closure.
 Mütze. Mikrofaser. Elastischer Verschluss.
 Casquette. Microfibre. Fermeture Élastique.
 Pet. Microfiber. Elastische Stütting.

Consult. 200 / 25 Print Code: F(1), N(8), O, P, R



19



softcool extreme
 UV PROTECTION

Fandol 5554

Cap. 55% Nylon/ 45% Polyester. Velcro Closure. UV50 Protection.
 Mütze. 55% Nylon/ 45% Polyester. Klett Verschluss. UV50 Schutz.
 Casquette. 55% Nylon/ 45% Polyester. Fermeture Velcro. Protection UV50.
 Pet. 55% Nylon/ 45% Polyester. Klittenband Stütting. UV50 Bescherming.

Consult. 200 / 25 Print Code: F(1), N(8), O, P, R

New



05



Brixa 20828

Cap. Microfibre. 5 Panels. Reflective. Velcro Closure.
Mütze. Mikrofaser. 5 Panels. Reflektierender. Klett Verschluss.
Casquette. Microfibre. 5 Panneaux. Réfléchissant. Fermeture Velcro.
Pet. Microfibrer. 5 Panelen. Reflecterend. Klittenband Stuiting.

Consult. 200 / 25 Print Code: F(1), N(8), O, P



07

Destada 20827

Cap. Microfibre. 6 Panels. Reflective. Velcro Closure.
Mütze. Mikrofaser. 6 Panels. Reflektierender. Klett Verschluss.
Casquette. Microfibre. 6 Panneaux. Réfléchissant. Fermeture Velcro.
Pet. Microfibrer. 6 Panelen. Reflecterend. Klittenband Stuiting.

Consult. 200 / 25 Print Code: F(1), N(8), O, P



05



03



07



19

Tarea 3120

Cap. 100% Cotton. 5 Panels. Velcro Closure. Reflective.
Mütze. 100% Baumwolle. 5 Panels. Klett Verschluss. Reflektierend.
Casquette. 100% Coton. 5 Panneaux. Fermeture Velcro. Réfléchissant.
Pet. 100% Katoen. 5 Panelen. Klittenband Stuiting. Reflecterend.

Consult. 300 / 30 Print Code: F(1), N(8), O, P



Working
Caps





Levant 20826

Cap. Microfibre. Elastic Closure.
Mütze. Mikrofaser. Elastischer Verschluss.
Casquette. Microfibre. Fermeture Élastique.
Pet. Microfibrer. Elastische Stutting.

Consult. 200 / 50 Print Code: F(1), N(8), O, P

13



06

04



136

Pamper 20825

Cap. Polyester RPET. 5 Panels. Plastic Closure.
Mütze. Polyester RPET. 5 Panels. Plastik Verschluss.
Casquette. Polyester RPET. 5 Panneaux. Fermeture Plastique.
Pet. Polyester RPET. 5 Panelen. Kunststof Sluiting.

Consult. 200 / 25 Print Code: F(1), N(8), O, P

04



Draken 6207

Hat. Microfibre.
Hut. Mikrofaser.
Bonnet. Microfibre.
Muts. Microfibrer.

Consult. 200 / 50 Print Code: F(1), N(8), O, P



Rambo 8080

Camouflage Cap. Cotton/ Polyester. 5 Panels. Velcro Closure.
Camouflage Mütze. Baumwolle/ Polyester. 5 Panels. Klettverschluss.
Casquette Camouflage. Coton/ Polyester. 5 Panneaux. Fermeture Velcro.
Camouflage Pet. Katoen/ Polyester. 5 Panelen. Klittenband Stutting.

Consult. 300 / 30 Print Code: F(1), N(8), O, P



19



02

01

04

05

07

11

03

Modiak 5239

Kids Cap. Microfibre/ Polyester. 5 Panels. Velcro Closure.

Kinder Mütze. Mikrofaser/ Polyester. 5 Panels. Klettverschluss.

Casquette Enfant. Microfibre/ Polyester. 5 Panneaux. Fermeture Velcro.

Kinder Pet. Microfibre/ Polyester. 5 Panelen. Klittenband Stuiting.



Consult.



300 / 50



Print Code: F(1), N(8), O, P, R



Kids Caps



05



01



03



19

Timón 3342

Kids Hat. 100% Cotton.

Kinder Hut. 100% Baumwolle.

Bonnet Enfant. 100% Coton.

Kinder Muts. 100% Katoen.



Consult.



200 / 50



Print Code: F(1), N(8), O, P



03



19



01



05

Sportkid 3329

Kids Cap. 100% Cotton. 5 Panels. Velcro Closure.

Kinder Mütze. 100% Baumwolle. 5 Panels. Klettverschluss.

Casquette Enfant. 100% Coton. 5 Panneaux. Fermeture Velcro.

Kinder Pet. 100% Katoen. 5 Panelen. Klittenband Stuiting.



Consult.



300 / 30



Print Code: F(1), N(8), O, P

Kids Caps



Rick 1534

Kids Cap. Polyester RPET. 5 Panels. Velcro Closure.
 Kinder Mütze. Polyester RPET. 5 Panels. Klett Verschluss.
 Casquette Enfant. Polyester RPET. 5 Panneaux. Fermeture Velcro.
 Kinder Pet. Polyester RPET. 5 Panelen. Klittenband Stütting.

Consult. 300 / 30 Print Code: F(1), N(8), O, P, R



ORGANIC COTTON



New



New



Avot 20506

Kids Cap. 100% Organic Cotton. 5 Panels. Velcro Closure.
 Kinder Mütze. 100% Organische Baumwolle. 5 Panels. Klett Verschluss.
 Casquette Enfant. 100% Organic Cotton. 5 Panneaux. Fermeture Velcro.
 Kinder Pet. 100% Organisch Katoen. 5 Panelen. Klittenband Stütting.

Consult. 200 / 50 Print Code: F(1), N(8), O, P



Lemkin 20507

Kids Cap. 100% Organic Cotton. 6 Panels. Buckle Closure.
 Kinder Mütze. 100% Organische Baumwolle. 6 Panels. Schnallen Verschluss.
 Casquette Enfant. 100% Organic Cotton. 6 Panneaux. Fermeture à Boucle.
 Kinder Pet. 100% Organisch Katoen. 6 Panelen. Gesp Stütting.

Consult. 200 / 50 Print Code: F(1), N(8), O, P





02

Garfy 9212

Bandana. Cotton/ Polyester.
Kopftuch. Baumwolle/ Polyester.
Bandana. Coton/ Polyester.
Bandana. Katoen/ Polyester.

Consult. 600 / 10 Print Code: E(1), N(8), O

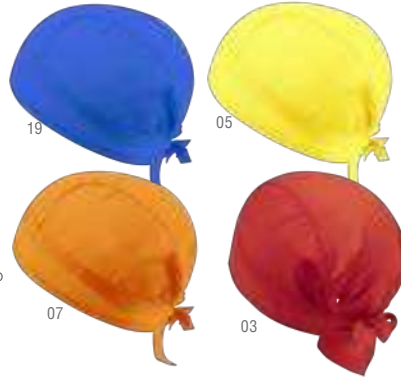

Plus 3029

Neckerchief. Polyester 170T.
Halstuch. Polyester 170T.
Foulard. Polyester 170T.
Bandana. Polyester 170T.

100 x 70 cm 1000 / 10 Print Code: F(1), N(8), R

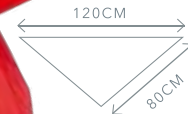
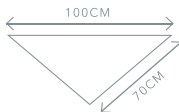

BIG SIZE

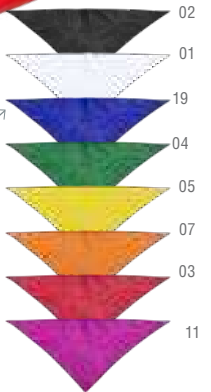

Kozma 4834

Neckerchief Wrap. Polyester 170T.
Halstuch. Polyester 170T.
Foulard Tissu. Polyester 170T.
Bandana. Polyester 170T.

120 x 80 cm 1000 / 10 Print Code: F(1), N(8), R

2in1
MULTI-FUNCTION



neckerchief

RECYCLED COTTON 

RPET 

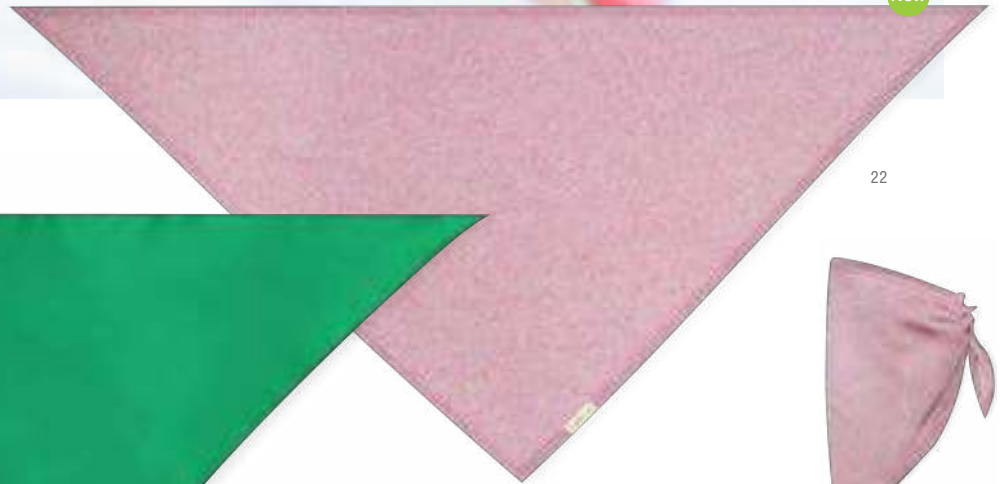

22

RPET 

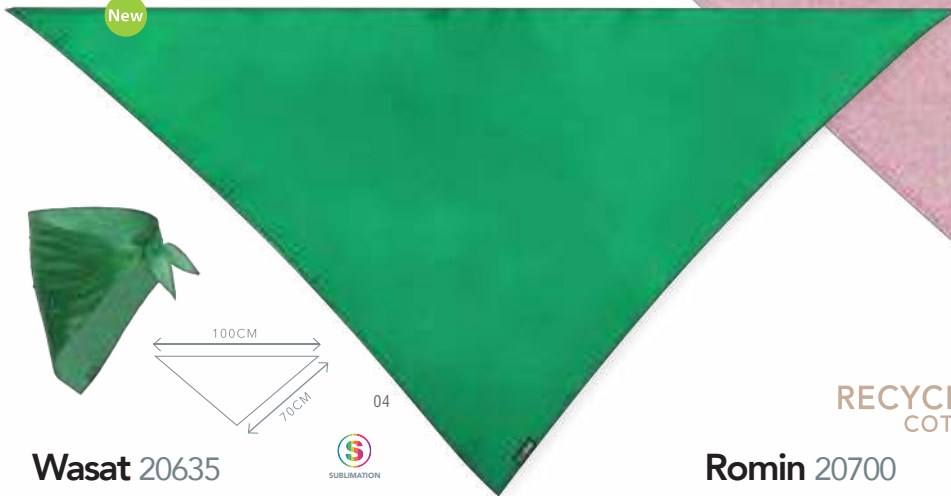

New

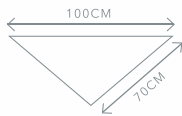

04



Wasat 20635

Neckerchief. Polyester 190T RPET.
Halstuch. Polyester 190T RPET.
Foulard. Polyester 190T RPET.
Bandana. Polyester 190T RPET.

 100 x 70 cm  1000 / 10
 Print Code: F(1), N(8), R



01

19

RECYCLED COTTON 

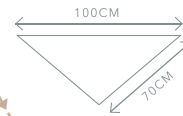

Romin 20700

Neckerchief. 100% Recycled Cotton.
Halstuch. 100% Recycling Baumwolle.
Foulard. 100% Coton Recyclé.
Bandana. 100% Gerecyclé Katoen.

 100 x 70 cm  200 / 50
 Print Code: F(6), N(8)



04

07

19

13

03





New

13



BORSALINO

Mestral 20824



INNER BAND

Hat. Straw.
Hut. Stroh.
Chapeau. Paille.
Hoed. Stro.

Consult. 250 Print Code: Consultar



04



Straw Hats



Bull 4190



INNER BAND



VENTILATION



TEXANO

Hat. Straw.
Hut. Stroh.
Chapeau. Paille.
Hoed. Stro.

Consult. 250 Print Code: Consultar



New

Leone 20823



INNER BAND



DALLAS

Hat. Straw.
Hut. Stroh.
Chapeau. Paille.
Hoed. Stro.

Consult. 250 Print Code: Consultar



Zelio 4930



Hat. Straw.
Hut. Stroh.
Chapeau. Paille.
Hoed. Stro.

Consult. 250 Print Code: Consultar



TYROL



Lúa 8085



INDIANA

Hat. Straw.
Hut. Stroh.
Chapeau. Paille.
Hoed. Stro.

Consult. 250 Print Code: Consultar



Vita 8086



INDIANA

Hat. Straw.
Hut. Stroh.
Chapeau. Paille.
Hoed. Stro.

Consult. 250 Print Code: Consultar



TYROL

117

Bauwens 5504



INNER BAND

Hat. Polyester.
Hut. Polyester.
Chapeau. Polyester.
Hoed. Polyester.

Consult. 100 / 25 Print Code: Consultar



13



18



13



INDIANA

Hindyp 4600



INNER BAND

Hat. Polyester.
Hut. Polyester.
Chapeau. Polyester.
Hoed. Polyester.

Consult. 100 / 25 Print Code: Consultar



08



01



13



BORSALINO

Timbu 3574



INNER BAND

Hat. Polyester.
Hut. Polyester.
Chapeau. Polyester.
Hoed. Polyester.

Consult. 100 / 25 Print Code: Consultar



01



08



02



New



13



Harmon 20822

Hat. Paper Straw.
Hut. Papierstroh.
Chapeau. Paille de Papier.
Hoed. Papieren Rietjes.

Consult. 100 / 25 Print Code: Consultar



TYROL



18



18



INDIANA

Mulins 1531

Hat. Paper Straw. Adjustable.
Hut. Papierstroh. Verstellbar.
Chapeau. Paille de Papier. Ajustable.
Hoed. Papieren Rietjes. Aanpasbaar.

Consult. 100 / 25 Print Code: Consultar



13

Adjustable
& External
Inside
Ribbon included



13



TYROL



13



13



INDIANA

Teilor 1038

Hat. Paper Straw. Adjustable.
Hut. Papierstroh. Verstellbar.
Chapeau. Paille de Papier. Ajustable.
Hoed. Papieren Rietjes. Aanpasbaar.

Consult. 100 / 25 Print Code: E(1), N(8)



18



01



01

Ranyit 1039

Hat. Paper Straw. Adjustable.
Hut. Papierstroh. Verstellbar.
Chapeau. Paille de Papier. Ajustable.
Hoed. Papieren Rietjes. Aanpasbaar.

Consult. 100 / 25 Print Code: E(1), N(8)





Braz 3575

Hat. Polyester.
Hut. Polyester.
Chapeau. Polyester.
Hoed. Polyester.



Consult.

200 / 25

Print Code: F(1)

INNER BAND



TYROL



Chizzer 6103

Hat. Paper Straw.
Hut. Papierstroh.
Chapeau. Paille de Papier.
Hoed. Papieren Rietjes.

INNER BAND



INDIANA

Consult. 100 / 25 Print Code: Consulnar



03



INDIANA

Splash 9195

Hat. Straw.
Hut. Stroh.
Chapeau. Paille.
Hoed. Stro.



Consult. 250 Print Code: Consulnar

INNER BAND

VENTILATION

Types of hats



TYROL

INDIANA

BORSALINO

TEXANO

DALLAS

Material hat band

925

HEADWARE



Natural Cotton

Natural Cork



Non-Woven

Polyester

Polyester Sublimation



INNER BAND

CINTA INTERIOR PARA UNA MAYOR COMODIDAD AL TIEMPO QUE GARANTIZA UNA MAYOR DURACIÓN DEL SOMBRERO.
 INNER BAND, GUARANTEEING MORE COMFORT AND LONGER DURABILITY.
 RUBAN INTÉRIEUR POUR UN MEILLEUR CONFORT, QUI GARANTIT UNE MEILLEURE CONSERVATION DU SOMBRERO.
 INNENBAND GELIEFERT FÜR OPTIMALEN TRAGEKOMFORT UND LÄNGERE LEBENSDAUER.
 NASTRO INTERNO PER CONSENTIRE AL CAPPELLO SIA UNA PIÙ COMODA VESTIBILITÀ CHE UNA PIÙ LUNGA DURATA.
 CINTA INTERIOR PARA MAIOR COMODIDADE E DURABILIDADE DO CHAPÉU.
 HEBBEN EENBINNENBAND, EEN GARANTIE VOOR MEER COMFORT EN DUURZAAMHEID.

RIBBON PRICE + PRINTING + SEWING

PRECIO DE CINTA + IMPRESIÓN + COSIDO

MINIMUM: 250 PCS

CHECK FOR 100 Pcs. - CONSULTAR PARA 100 UDS.
 SET UP NOT INCLUDED - CLICHÉ NO INCLUIDO

SCREEN PRINTING: 1 COLOR INCLUDED - SERIGRAFÍA: 1 COLOR INCLUIDA



3'7 CM

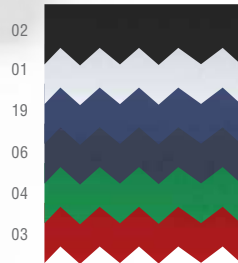

Hicoband 1532

Hatband, Polyester.
 Hut Band, Polyester.
 Ruban Chapeau, Polyester.
 Hoedenband, Polyester.

67 x 3.7 cm Print Code: Consultar

SUBLIMATION: FULL COLOR INCLUDED - SUBLIMACIÓN: A TODO COLOR INCLUIDO



3'7 CM

Hico Sublimation 6761

Hatband, Polyester.
 Hut Band, Polyester.
 Ruban Chapeau, Polyester.
 Hoedenband, Polyester.

67 x 3.7 cm Print Code: Consult.

MINIMUM: 250 PCS

CHECK FOR 100 Pcs. - CONSULTAR PARA 100 UDS.
SET UP NOT INCLUDED - CLICHÉ NO INCLUIDO

3 CM

SCREEN PRINTING: 1 COLOR INCLUDED - SERIGRAFIA: 1 COLOR INCLUIDA



Cottonband 1034

Hatband, 100% Recycled Cotton.
Hut Band, 100% Recycling Baumwolle.
Ruban Chapeau, 100% Coton Recyclé.
Hoedenband, 100% Gerecycled Katoen.

67 x 3 cm Print Code: Consultar

Check for more than one color printing
Consultar impresión a más de un color

3'2 CM

SUBLIMATION: FULL COLOR INCLUDED - SUBLIMACIÓN: A TODO COLOR INCLUIDO



Hatband, Polyester.
Hut Band, Polyester.
Ruban Chapeau, Polyester.
Hoedenband, Polyester.

67 x 3.2 cm Print Code: Consult.

Check for more than one color printing
Consultar impresión a más de un color

3'2 CM

SCREEN PRINTING: 1 COLOR INCLUDED - SERIGRAFIA: 1 COLOR INCLUIDA



Hatband, Non-Woven.
Hut Band, Non-Woven.
Ruban Chapeau, T.N.T.
Hoedenband, Non-Woven.

67 x 3.2 cm Print Code: Consult.

Check for more than one color printing
Consultar impresión a más de un color

3'2 CM

SCREEN PRINTING: 1 COLOR INCLUDED - SERIGRAFIA: 1 COLOR INCLUIDA

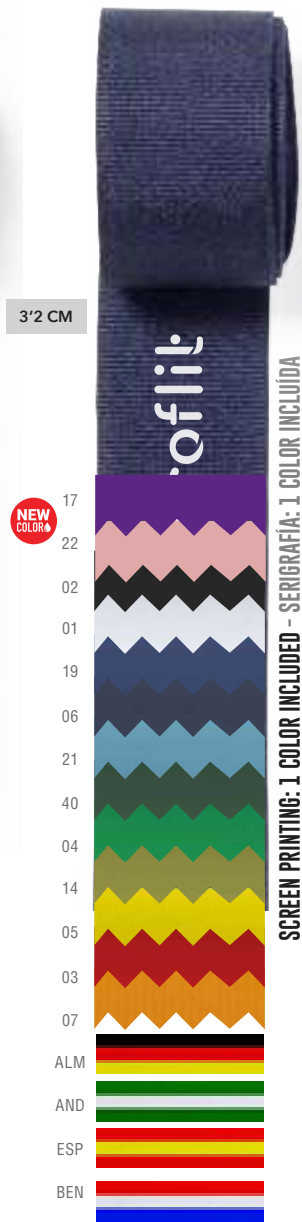

Hatband, Polyester.
Hut Band, Polyester.
Ruban Chapeau, Polyester.
Hoedenband, Polyester.

67 x 3.2 cm Print Code: Consult.

Check for more than one color printing
Consultar impresión a más de un color

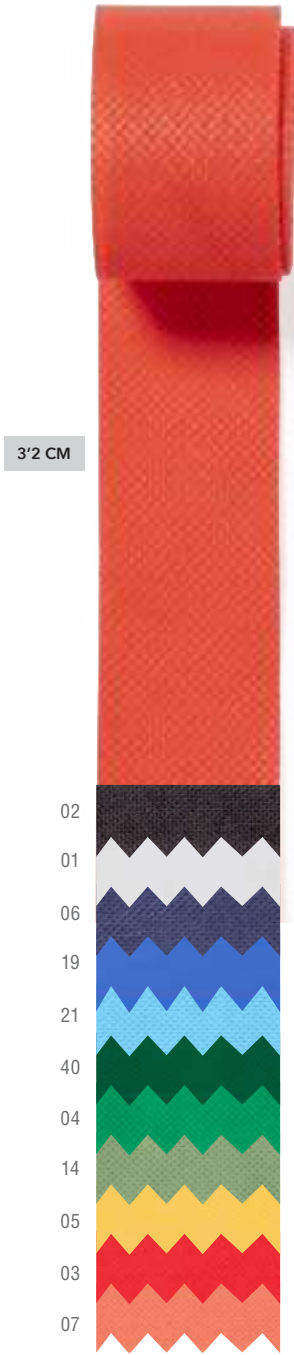

3'2 CM

Sprint 2008C

Hatband, Non-Woven.
Hut Band, Non-Woven.
Ruban Chapeau, T.N.T.
Hoedenband, Non-Woven.

67 x 3.2 cm 3000 / 50

Print Code: Consult.



3'2 CM

Polyester 5447

Hatband, Polyester.
Hut Band, Polyester.
Ruban Chapeau, Polyester.
Hoedenband, Polyester.

67 x 3.2 cm 3000

Print Code: Consult.

FULL ROLL ONLY
ROLLO COMPLETO

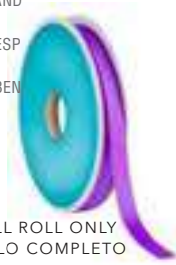

2'7 CM

Menas 5730

Hatband, Non-Woven.
Hut Band, Non-Woven.
Ruban Chapeau, T.N.T.
Hoedenband, Non-Woven.

67 x 2.7 cm 5000

Print Code: Consult.

IDEAL FOR
PRINTING

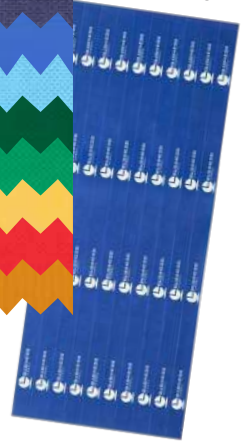

Plancha 10 cintas
Plate 10 ribbons

25 SUN & SUMMER





**JOY,
CHILL,
PLAY**



Dayane 1726

Fan. 2 Modes. 3 Batteries AAA Not Included.
Ventilator. 2 Positionen. 3 AAA Batterien Nicht im Lieferumfang.
Ventilateur. 2 Modes. 3 Piles AAA Non Incluses.
Ventilator. 2 Posities. 3 Batterijen AAA Niet Inclusief.

8 x 17.5 x 2.5 cm 100 / 50 Print Code: D(4)

New



Sartor 21226

Fan. 2 Batteries AA Not Included.
Ventilator. 2 AA Batterien Nicht im Lieferumfang.
Ventilateur. 2 Piles AA Non Incluses.
Ventilator. 2 Batterijen AA Niet Inclusief.

6.6 x 15 x 4 cm 100 / 50 Print Code: D(4)

New



Manhattan 21174

Fan. Manual.
Ventilator. Manueller.
Ventilateur. Manuel.
Ventilator. Hand.

7 x 13.5 x 3.5 cm 500 / 20 Print Code: D(4)

New



35 ml

07



Bluco 20769

Vaporizer Fan. 35 ml. 1 Battery AA Not Included.
Zerstäuber Ventilator. 35 ml. 1 AA Batterie Nicht im Lieferumfang.
Ventilateur Vaporisateur. 35 ml. 1 Pile AA Non Inclusive.
Sproeier Ventilator. 35 ml. 1 Batterij AA Niet Inclusief.

10 x 7 x 2.6 cm 100 / 50 Print Code: D(1)

35 ml



NEW COLOR



01

19

Hendry 6014

Vaporizer Fan. 35 ml. 2 Batteries AA Not Included.
Zerstäuber Ventilator. 35 ml. 2 AA Batterien Nicht im Lieferumfang.
Ventilateur Vaporisateur. 35 ml. 2 Piles AA Non Incluses.
Sproeier Ventilator. 35 ml. 2 Batterijen AA Niet Inclusief.

8.5 x 16 x 8 cm 100 / 50 Print Code: D(4)

70 ml



01

03

Bangui 3593 19

Vaporizer. 70 ml.
Zerstäuber. 70 ml.
Vaporisateur. 70 ml.
Sproeier. 70 ml.

Ø 3.2 x 21.5 cm 100 / 25 Print Code: D(4)





2 in 1

Benard 20766

Fan. Foldable. 3 Modes. Battery 400 mAh.
 Ventilator. Faltbar. 3 Positionen. Batterie 400 mAh.
 Ventilateur. Pliable. 3 Modes. Batterie 400 mAh.
 Ventilator. Opvouwbaar. 3 Posities. Batterij 400 mAh.

8 x 14,2 x 2,5 cm 50 Print Code: E(4)



Sherman 20767

Fan. 3 Modes. Battery 800 mAh.
 Ventilator. 3 Positionen. Batterie 800 mAh.
 Ventilateur. 3 Modes. Batterie 800 mAh.
 Ventilator. 3 Posities. Batterij 800 mAh.

14 x 22 x 6,2 cm 50 Print Code: F(1)



350 ml

Zexen 20737

Fan Bottle. Tritan. 350 ml. 3 Modes. Battery 1.200 mAh.
 Trinkflasche Ventilator. Tritan. 350 ml. 3 Positionen. Batterie 1.200 mAh.
 Bidon Ventilateur. Tritan. 350 ml. 3 Modes. Batterie 1.200 mAh.
 Fles Ventilator. Tritan. 350 ml. 3 Posities. Batterij 1.200 mAh.

8,5 x 16 cm 50 Print Code: F(1)



2 in 1

Fanger 20765

Holder Fan. 3 Modes. Battery 300 mAh.
 Halter Ventilator. 3 Positionen. Batterie 300 mAh.
 Ventilateur Support. 3 Modes. Batterie 300 mAh.
 Houder Ventilator. 3 Posities. Batterij 300 mAh.

7,8 x 13,2 x 2,8 cm 100 / 50 Print Code: E(4)



Lencer 6468

Hand Fan. Bamboo Fibre/ PP/ Polyester RPET.
 Fächer. Bambusfaser/ PP/ Polyester RPET.
 Éventail. Fibre Bambou/ PP/ Polyester RPET.
 Waaler. Bamboe Fibre/ PP/ Polyester RPET.

42.5 x 23 cm 250 / 25 Print Code: D(1), E(2), L1



RPET



02



03



11

22

01

04

05

Tela 8096

Hand Fan. PP/ Polyester.
 Fächer. PP/ Polyester.
 Éventail. PP/ Polyester.
 Waaler. PP/ Polyester.

43 x 23 cm 250 / 25 Print Code: D(1), E(2)

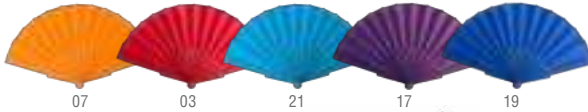

07

03

21

17

19



01

02

04

19

Pumik 1606

Hand Fan. Recycled PP/ Polyester RPET.
 Fächer. PP Recycling/ Polyester RPET.
 Éventail. PP Recyclé/ Polyester RPET.
 Waaler. Gerecycled PP/ Polyester RPET.

43 x 23 cm 250 / 25 Print Code: D(1), E(2)



RPET



RPET

Woter 6467

Hand Fan. Wood/ Polyester RPET.
Fächer. Holz/ Polyester RPET.
Éventail. Bois/ Polyester RPET.
Waaier. Houten/ Polyester RPET.



42.5 x 23 cm 250 / 25 Print Code: D(1), E(2), L1



11



02 01 07 05 228 03
Folklore 8863

Hand Fan. Wood/ Cotton/ Polyester.
Fächer. Holz/ Baumwolle/ Polyester.
Éventail. Bois/ Coton/ Polyester.
Waaier. Houten/ Katoen/ Polyester.



17

04

42.5 x 23 cm 250 / 25
 Print Code: D(1), E(2), L1



Madera 8097

Hand Fan. Wood.
Fächer. Holz.
Éventail. Bois.
Waaier. Hout.

35 x 20 cm 250 / 25 Print Code: D(1), E(2), L1



19



17

05

03

07

11

01

16

02

Kronix 6406

Hand Fan. Bamboo/ Polyester.
Fächer. Bambus/ Polyester.
Éventail. Bambou/ Polyester.
Waaier. Bamboe/ Polyester.

38 x 21 cm 600 / 100 Print Code: D(1), E(2), L1

BAMBOO



BAMBOO

Claren 20763

Hand Fan. Bamboo/ Polyester.
 Fächer. Bambus/ Polyester.
 Éventail. Bambou/ Polyester.
 Waaier. Bamboe/ Polyester.

38 x 21 cm 600 / 100
 Print Code: D(1), E(2), L1

**Sayiri 20762**

Hand Fan. Wood/ Polyester.
 Fächer. Holz/ Polyester.
 Éventail. Bois/ Polyester.
 Waaier. Houten/ Polyester.

42.5 x 23 cm 250 / 25
 Print Code: D(1), E(2), L1

**Dubert 6407**

Hand Fan. Wood/ Cotton.
 Fächer. Holz/ Baumwolle.
 Éventail. Bois/ Coton.
 Waaier. Hout/ Katoen.

42.5 x 23 cm 250 / 25
 Print Code: D(1), E(2), L1

Natural
Cork**Kasol 6476**

Hand Fan. Wood/ Cork.
 Fächer. Holz/ Kork.
 Éventail. Bois/ Liège.
 Waaier. Houten/ Kurk.

41.5 x 23 cm 250 / 25
 Print Code: D(1), E(2), L1





Kerry 8864

Pai Pai. Translucent.
Pay-Pay. Durchscheinend.
Pai Pai. Translucide.
Pai Pai. Doorschijnend.

18 x 24.2 cm 500 / 100 Print Code: E(1)

03



Stilo 3132

Pai Pai. Foldable.
Pay-Pay. Faltbar.
Pai Pai. Pliable.
Pai Pai. Opvouwbaar.

24.5 x 26 cm 500 / 125 Print Code: C(4)



Bilsom 1017

Hand Fan. Recycled Cardboard.
Fächer. Recycling Pappe.
Éventail. Carton Recyclé.
Waier. Gerecycled Karton.

30.5 x 17.5 cm 500 / 100 Print Code: C(1)



Olbran 1607

Pai Pai. Bamboo/ Polyester.
Pay-Pay. Bambus/ Polyester.
Pai Pai. Bamboe/ Polyester.
Pai Pai. Bamboe/ Polyester.

24 x 35 x 0.9 cm 100 / 10 Print Code: E(1), L1, N(8), R



Prakay 1603

Sunglasses. Coffee Fibre/ PP/ Wood. UV400 Protection.
 Sonnenbrille. Kaffeeleaser/ PP/ Holz. UV400 Schutz.
 Lunettes de Soleil. Fibre de café/ PP/ Bois. Protection UV400.
 Zonnebril. Koffievezel/ PP/ Hout. UV400 Bescherming.

Consult. 300 / 10 Print Code: E(4), L1



MADE FROM
COFFEE
 -FIBER-

Tinex 6355

Sunglasses. Bamboo/ Bamboo Fibre/ PP. UV400 Protection.
 Sonnenbrille. Bambus/ Bambusfaser/ PP. UV400 Schutz.
 Lunettes de Soleil. Bambou/ Fibre Bambou/ PP. Protection UV400.
 Zonnebril. Bamboe/ Bamboe Fibre/ PP. UV400 Bescherming.

Consult. 300 / 10 Print Code: D(4), L1



Bamboo &
 Wheat Straw

LIMITED
edition
 EXPERIENCE



Thezin 1613

Sunglasses. Bamboo. Mirrored Lenses. UV400 Protection. Polyester Pouch.
 Sonnenbrille. Bambus. Spiegeleffekt-Linsen. UV400 Schutz. Polyester Etui.
 Lunettes de Soleil. Bambou. Verres à Effet Miroir. Protection UV400. Étui Polyester.
 Zonnebril. Bamboe. Spiegeleffect Lenzen. UV400 Bescherming. Polyester Zakje.

Consult. 100 / 20 Print Code: F(1), L2



Dristan 21052

Sunglasses. Bamboo/ AC. Mirrored Lenses. UV400 Protection.
 Sonnenbrille. Bambus/ AC. Spiegeleffekt-Linsen. UV400 Schutz.
 Lunettes de Soleil. Bambou/ AC. Verres à Effet Miroir. Protection UV400.
 Zonnebril. Bamboe/ AC. Spiegeleffect Lenzen. UV400 Bescherming.

Consult. 300 / 10 Print Code: E(4), L1



Ferguson 20764

Sunglasses. Bamboo/ PC. Mirrored Lenses. UV400 Protection.
 Sonnenbrille. Bambus/ PC. Spiegeleffekt-Linsen. UV400 Schutz.
 Lunettes de Soleil. Bambou/ PC. Verres à Effet Miroir. Protection UV400.
 Zonnebril. Bamboe/ PC. Spiegeleffect Lenzen. UV400 Bescherming.

Consult. 300 / 10 Print Code: E(4), L1



Mitrox 6810

Sunglasses. Bamboo/ PC. Mirrored Lenses. UV400 Protection.
 Sonnenbrille. Bambus/ PC. Spiegeleffekt-Linsen. UV400 Schutz.
 Lunettes de Soleil. Bambou/ PC. Verres à Effet Miroir. Protection UV400.
 Zonnebril. Bamboe/ PC. Spiegeleffect Lenzen. UV400 Bescherming.

Consult. 300 / 10 Print Code: E(4), L1



Graham 1030

Sunglasses. Bamboo/ PC. Mirrored Lenses. UV400 Protection.
 Sonnenbrille. Bambus/ PC. Spiegeleffekt-Linsen. UV400 Schutz.
 Lunettes de Soleil. Bambou/ PC. Verres à Effet Miroir. Protection UV400.
 Zonnebril. Bamboe/ PC. Spiegeleffect Lenzen. UV400 Bescherming.

Consult. 300 / 10 Print Code: E(4), L1



Scutel 1029

Sunglasses. Cork/ PC. UV400 Protection.
 Sonnenbrille. Kork/ PC. UV400 Schutz.
 Lunettes de Soleil. Liège/ PC. Protection UV400.
 Zonnebril. Kurk/ PC. UV400 Bescherming.

Consult. 300 / 10 Print Code: E(4), L1



Cork

RPET

Sigma 6811



Kilpan 6354

Bamboo Fibre



Wheat Straw

Mirfat 1031



Poren 1605

RPET



Sigma 6811

Sunglasses. RPET. UV400 Protection.
 Sonnenbrille. RPET. UV400 Schutz.
 Lunettes de Soleil. RPET. Protection UV400.
 Zonnebril. RPET. UV400 Bescherming.

Consult. 300 / 10 Print Code: E(4)



Poren 1605

Sunglasses. RPET. Mirrored Lenses. UV400 Protection.
 Sonnenbrille. RPET. Spiegeleffekt-Linsen. UV400 Schutz.
 Lunettes de Soleil. RPET. Verres à Effet Miroir. Protection UV400.
 Zonnebril. RPET. Spiegeleffect Lenzen. UV400 Bescherming.

Consult. 300 / 10 Print Code: E(4)



Kilpan 6354

Sunglasses. Bamboo Fibre/ PP. UV400 Protection.
 Sonnenbrille. Bambusfaser/ PP. UV400 Schutz.
 Lunettes de Soleil. Fibre Bambou/ PP. Protection UV400.
 Zonnebril. Bamboe Fibre/ PP. UV400 Bescherming.

Consult. 300 / 10 Print Code: D(4)



Mirfat 1031

Sunglasses. Wheat Straw/ PP. UV400 Protection.
 Sonnenbrille. Weizenstroh/ PP. UV400 Schutz.
 Lunettes de Soleil. Paille de Blé/ PP. Protection UV400.
 Zonnebril. Tarwestro/ PP. UV400 Bescherming.

Consult. 300 / 10 Print Code: E(4)



04



Leychan 5923

Sunglasses. UV400 Protection.
 Sonnenbrille. UV400 Schutz.
 Lunettes de Soleil. Protection UV400.
 Zonnebril. UV400 Bescherming.

Consult. 300 / 10 Print Code: D(4)



02



Xaloc 7000

Sunglasses. UV400 Protection.
 Sonnenbrille. UV400 Schutz.
 Lunettes de Soleil. Protection UV400.
 Zonnebril. UV400 Bescherming.

Consult. 300 / 10 Print Code: D(4)



01



Nixtu 5284

Sunglasses. UV400 Protection.
 Sonnenbrille. UV400 Schutz.
 Lunettes de Soleil. Protection UV400.
 Zonnebril. UV400 Bescherming.

Consult. 300 / 10 Print Code: D(4)



Gredel 4799

Sunglasses. Mirrored Lenses. UV400 Protection.
 Sonnenbrille. Spiegeleffekt-Linsen. UV400 Schutz.
 Lunettes de Soleil. Verres à Effet Miroir. Protection UV400.
 Zonnebril. Spiegeleffect Lenzen. UV400 Bescherming.

Consult. 300 / 10 Print Code: D(4)



04



04



Nival 4581

Sunglasses, Mirrored Lenses, UV400 Protection.
 Sonnenbrille, Spiegeleffekt-Linsen, UV400 Schutz.
 Lunettes de Soleil, Verres à Effet Miroir, Protection UV400.
 Zonnebril, Spiegeleffect Lenzen, UV400 Bescherming.

Consult. 300 / 10 Print Code: D(4)



Harvey 4217

Sunglasses, Mirrored Lenses, UV400 Protection.
 Sonnenbrille, Spiegeleffekt-Linsen, UV400 Schutz.
 Lunettes de Soleil, Verres à Effet Miroir, Protection UV400.
 Zonnebril, Spiegeleffect Lenzen, UV400 Bescherming.

Consult. 300 / 10 Print Code: D(4)



02



02



03



Malter 4094

Sunglasses, UV400 Protection.
 Sonnenbrille, UV400 Schutz.
 Lunettes de Soleil, Protection UV400.
 Zonnebril, UV400 Bescherming.

Consult. 300 / 10 Print Code: D(4)

Spike 7003

Kids Sunglasses, UV400 Protection.
 Kindersonnenbrille, UV400 Schutz.
 Lunettes de Soleil Enfant, Protection UV400.
 Kinder Zonnebril, UV400 Bescherming.

Consult. 400 / 10 Print Code: D(4)

KIDS

Premia 9993

Sunglasses, UV400 Protection.
 Sonnenbrille, UV400 Schutz.
 Lunettes de Soleil, Protection UV400.
 Zonnebril, UV400 Bescherming.

Consult. 300 / 10 Print Code: D(4)



11 02 05 07

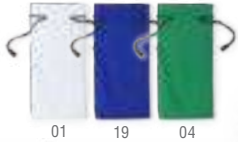

01 19 04



Milla 9994

Pouch, Polyester.
Hülle, Polyester.
Étui, Polyester.
Hoes, Polyester.

9 x 18 cm 1000 / 50
Print Code: E(2), N(8)

03



New



02 03 04

Torlax 20761

Pouch, Polyester RPET.
Hülle, Polyester RPET.
Étui, Polyester RPET.
Hoes, Polyester RPET.

9,5 x 18 cm 1000 / 500
Print Code: D(1), N(8)

19



Ekain 4390



Pouch, Polyester.
Hülle, Polyester.
Étui, Polyester.
Hoes, Polyester.

9 x 18 cm 1000 / 50 Print Code: D(1), N(8), R



Kalermix 1604

Pouch, Felt RPET.
Hülle, Filz RPET.
Étui, Feutrine RPET.
Hoes, Vilt RPET.

9,5 x 18 cm 500 / 50 Print Code: D(1), N(8)



Silmax 6629

Pouch, Polyester.
Hülle, Polyester.
Étui, Polyester.
Hoes, Polyester.

9 x 18 cm 1000 / 50 Print Code: D(1), N(8)

Kanger 21096

Flip Flops. EVA/ PU.
 Flip Flop. EVA/ PU.
 Tongues. EVA/ PU.
 Flip Flops. EVA/ PU.

36-37, 38-39, 40-41, 42-43, 44-45
 Print Code: E(1)



06

Caimán 9860

Flip Flops. EVA/ Polyester.
 Flip Flop. EVA/ Polyester.
 Tongues. EVA/ Polyester.
 Flip Flops. EVA/ Polyester.

36-38, 42-44
 Print Code: E(1), N(8)



03



07



02

19



New

Manisok 21097

Flip Flops. EVA/ PVC.
 Flip Flop. EVA/ PVC.
 Tongues. EVA/ PVC.
 Flip Flops. EVA/ PVC.

36-38, 42-44
 Print Code: D(1), E(1)



02



Sebrin 6441

Flip Flops. EVA/ PVC.
 Flip Flop. EVA/ PVC.
 Tongues. EVA/ PVC.
 Flip Flops. EVA/ PVC.

36-38, 42-44
 Print Code: D(1), E(1), L1



Yassir 1751

Flip Flops. EVA/ Cork/ Polyester.
 Flip Flop. EVA/ Kork/ Polyester.
 Tongues. EVA/ Liège/ Polyester.
 Flip Flops. EVA/ Kurk/ Polyester.

36-38, 42-44
 Print Code: F(1), L2, N(8)

LIMITED edition EXPERIENCE





19

Brasileira 9343

Flip Flops. EVA/ PVC.
 Flip Flop. EVA/ PVC.
 Tongues. EVA/ PVC.
 Flip Flops. EVA/ PVC.

36-38, 42-44 40 / 10 Print Code: E(1)



07

03



01

04



02

Salti 8884

Flip Flops. EVA/ PVC.
 Flip Flop. EVA/ PVC.
 Tongues. EVA/ PVC.
 Flip Flops. EVA/ PVC.

36-38, 42-44 60 / 10 Print Code: D(1), E(1)



02

01

Tapiok 1602

Flip Flops. Recycled EVA/ PVC. Sizes: 36-38, 42-44.
 Flip Flop. Recycling EVA/ PVC. Größen: 36-38, 42-44.
 Tongues. EVA Recyclé/ PVC. Tailles: 36-38, 42-44.
 Flip Flops. Gerecycled EVA/ PVC. Maat: 36-38, 42-44.

36-38, 42-44 60 / 10 Print Code: D(1), E(1)



Badrak 1752



Sublimation Flip Flops. EVA/ PVC/ Polyester. Sizes: 36-38, 42-44.
 Sublimations Flip Flop. EVA/ PVC/ Polyester. Größen: 36-38, 42-44.
 Tongues Sublimation. EVA/ PVC/ Polyester. Tailles: 36-38, 42-44.
 Sublimatie Flip Flops. EVA/ PVC/ Polyester. Maat: 36-38, 42-44.

36-38, 42-44 20 Print Code: Q(1), R





NEW COLOR



Cretus 1020

Sunscreen Lotion. 30 ml. SPF30.
Sonnenschutzmittel. 30 ml. SPF30.
Crème Solaire. 30 ml. SPF30.
Zonnebrandcrème. 30 ml. SPF30.

4.7 x 9.5 x 2.4 cm 200 / 50
Print Code: C(4)

05



New



03

SUNSCREEN

LIP BALM

Canen 20567



Set. Sunscreen Lotion SPF30, Lip Balm SPF15, Vanilla Aroma.
Set. Sonnenschutzmittel SPF30, Lippenbalsam SPF15, Vanille Aroma.
Set. Crème Solaire SPF30, Baume Lèvres SPF15, Arôme Vanille.
Set. Zonnebrandcrème SPF30, Lippenbalsam SPF15, Vanille Aroma.

Ø 2 x 9 cm 500 / 50 Print Code: C(4)



04

05

07

11

19

01

New



Yohan 20568

Set. PP. Sunscreen Lotion SPF30, After Sun, Hydroalcoholic Gel, Citronella Spray and Soothing for Bites.
Set. PP. Sonnenschutzmittel SPF30, After Sun, Hydroalkoholisches Gel, Zitronellenspray und Beruhigungsmittel für Stiche.
Set. PP. Crème Solaire SPF30, After Sun, Gel Hydroalcoolique, Spray à la Citronnelle et Apaisant pour les Piqûres.
Set. PP. Zonnebrandcrème SPF30, After Sun, Hydroalkoholische Gel, Citronellaspray en Verzachtend bij Beten.

11 x 13.5 x 2 cm 80 / 40
Print Code: D(1), W



WATERPROOF



New



05

Dalmas 20760

Multipurpose Bag. PVC. Waterproof.
Mehrzwecktasche. PVC. Wasserabweisende.
Fourre-Tout. PVC. Imperméable.
Multifunctioneel Tasje. PVC. Waterdicht.

25.5 x 19 x 10 cm 100 / 50 Print Code: F(1)



01



03



21

New



Jagsen 20465

Bag. PVC. Waterproof.
Tasche. PVC. Wasserabweisende.
Sac. PVC. Imperméable.
Tas. PVC. Waterdicht.

49 x 48 x 25 cm 25 Print Code: G(1)



New



Nandora 20466

Bag. PVC. Waterproof.
Tasche. PVC. Wasserabweisende.
Sac. PVC. Imperméable.
Tas. PVC. Waterdicht.

44.5 x 48 x 19 cm 25 Print Code: G(1)

WATERPROOF

WATERPROOF

Bag & Backpack

9 L



04



02

19

01

05

03

Tinsul 4848

Bag, Ripstop, 9 L, Waterproof.
Tasche, Ripstop, 9 L, Wasserabweisende.
Sac, Ripstop, 9 L, Imperméable.
Tas, Ripstop, 9 L, Waterdicht.

📏 Ø 18.5 x 36 cm 📦 100 / 10 🖨️ Print Code: H(1)

2.3 L



19



05

02

01

03

Kinser 4847

Bag, Ripstop, 2.3 L, Waterproof.
Tasche, Ripstop, 2.3 L, Wasserabweisende.
Sac, Ripstop, 2.3 L, Imperméable.
Tas, Ripstop, 2.3 L, Waterdicht.

📏 Ø 11.5 x 26 cm 📦 200 / 10 🖨️ Print Code: H(1)

2 L



03



01

05

19

Kambax 6564

Bag, Ripstop, 2 L, Waterproof, Touch Screen.
Tasche, Ripstop, 2 L, Wasserabweisende, Touch Screen.
Sac, Ripstop, 2 L, Imperméable, Écran Tactile.
Tas, Ripstop, 2 L, Waterdicht, Touch Screen.

📏 Ø 11 x 29.5 cm 📦 200 / 10 🖨️ Print Code: G(1)

WATERPROOF RPET

947

SUN & SUMMER

New

5 L



02 05 19



03

Veronia 20462

Bag, Polyester 300D RPET, 5 L, Waterproof.
Tasche, Polyester 300D RPET, 5 L, Wasserabweisend.
Sac, Polyester 300D RPET, 5 L, Imperméable.
Tas, Polyester 300D RPET, 5 L, Waterdicht.

📏 Ø 17.5 x 35 cm 📦 100 / 10 🖨️ Print Code: G(1), N(8)

10 L

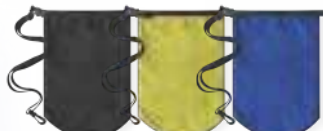

02 05 19

New



03

Kasolin 20463

Bag, Polyester 300D RPET, 10 L, Waterproof.
Tasche, Polyester 300D RPET, 10 L, Wasserabweisend.
Sac, Polyester 300D RPET, 10 L, Imperméable.
Tas, Polyester 300D RPET, 10 L, Waterdicht.

📏 Ø 20 x 46 cm 📦 50 / 10 🖨️ Print Code: G(1), N(8)

20 L



01 05 19



03

Tayrux 6513

Backpack, Ripstop, 20 L, Waterproof.
Rucksack, Ripstop, 20 L, Wasserabweisend.
Sac à Dos, Ripstop, 20 L, Imperméable.
Rugzak, Ripstop, 20 L, Waterdicht.

📏 Ø 23 x 63 cm 📦 20 🖨️ Print Code: H(1)

New

25 L

RPET



03 02 19

Ardentix 20464

Backpack, Polyester 300D RPET, 25 L, Waterproof, Touch Screen.
Rucksack, Polyester 300D RPET, 25 L, Wasserabweisend, Touch Screen.
Sac à Dos, Polyester 300D RPET, 25 L, Imperméable, Écran Tactile.
Rugzak, Polyester 300D RPET, 25 L, Waterdicht, Touch Screen.

📏 37 x 55 x 13 cm 📦 30 / 10 🖨️ Print Code: H(1), N(8)



04

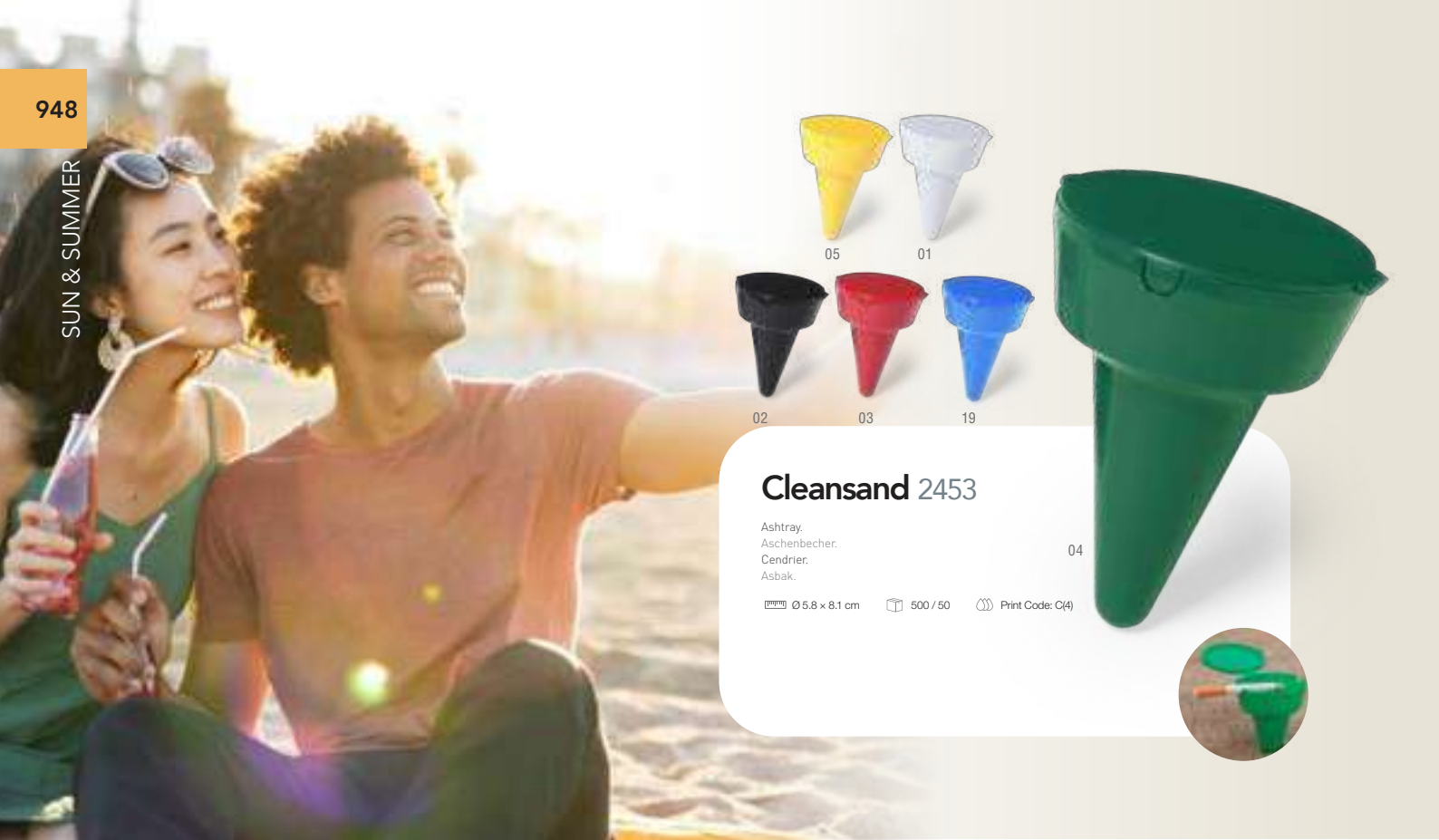

Cleansand 2453

Ashtray.
Aschenbecher.
Cendrier.
Asbak.

04

📏 Ø 5,8 × 8,1 cm 📦 500 / 50 🔄 Print Code: C(4)

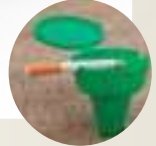

01



04

19

08

02

03

Berko 5696

Pocket Ashtray. PVC/ Aluminium.
Tasche Aschenbecher. PVC/ Aluminium.
Cendrier Poche. PVC/ Aluminium.
Zak-Asbak. PVC/ Aluminium.



📏 8 × 8 × 1 cm 📦 500 / 50 🔄 Print Code: C(1)



Flament 1600

Pocket Ashtray. Laminated Recycled Paper/ Aluminium.
Tasche Aschenbecher. Laminiertes Recycling Papier/ Aluminium.
Cendrier Poche. Papier Recyclé Laminé/ Aluminium.
Zak-Asbak. Gelamineerd Gerecycled Papier/ Aluminium.

📏 7,5 × 8,5 × 1 cm 📦 500 / 50 🔄 Print Code: C(1)



Dokon 1599

Pocket Ashtray. Cork/ Aluminium.
Tasche Aschenbecher. Kork/ Aluminium.
Cendrier Poche. Liège/ Aluminium.
Zak-Asbak. Kurk/ Aluminium.

📏 8 × 8 × 1 cm 📦 500 / 50 🔄 Print Code: C(1)

WATERPROOF & TACTILE



19

Arsax 4777

Multipurpose Bag. PVC. Waterproof. Touch Screen.
 Mehrzwecktasche. PVC. Wasserdicht. Touch Screen.
 Fourre-Tout. PVC. Imperméable. Écran Tactile.
 Multifunctioneel Tasje. PVC. Waterdicht. Touch Screen.

13 x 24.5 cm 300 / 50 Print Code: F(1)



19

Tamy 4097

Multipurpose Bag. PVC. Waterproof. Touch Screen.
 Mehrzwecktasche. PVC. Wasserdicht. Touch Screen.
 Fourre-Tout. PVC. Imperméable. Écran Tactile.
 Multifunctioneel Tasje. PVC. Waterdicht. Touch Screen.

13 x 24.5 cm 300 / 50 Print Code: F(1)

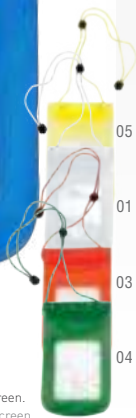

03

Rokdem 1610

Multipurpose Bag. PVC. Waterproof. Touch Screen.
 Mehrzwecktasche. PVC. Wasserdicht. Touch Screen.
 Fourre-Tout. PVC. Imperméable. Écran Tactile.
 Multifunctioneel Tasje. PVC. Waterdicht. Touch Screen.

10 x 23.5 cm 500 / 50 Print Code: F(1)



New

RECYCLED COTTON
Global Recycled Standard

Lainen 20752

180 x 90 cm

Towel Pareo. 100% Recycled Cotton 180 g/ m2.
Strandsarong. 100% Recycling Baumwolle 180 g/ m2.
Paréo Serviette. 100% Coton Recyclé 180 g/ m2.
Omslag Handdoek. 100% Gerecycled Katoen 180 g/ m2.

180 x 90 cm 30 Print Code: F(1), N(8), P



New



Harlow 20753

180 x 90 cm

Towel Pareo. 100% Recycled Cotton/ Polyester 250 g/ m2.
Strandsarong. 100% Recycling Baumwolle/ Polyester 250 g/ m2.
Paréo Serviette. 100% Coton Recyclé/ Polyester 250 g/ m2.
Omslag Handdoek. 100% Gerecycled Katoen/ Polyester 250 g/ m2.

180 x 90 cm 25 Print Code: F(1), N(8), P



TERRY TOWEL



ORGANIC COTTON



Prik 1183

180 x 90 cm

Towel Pareo. 50% Organic Cotton/ 50% Polyester 280 g/ m2.
Strandsarong. 50% Organische Baumwolle/ 50% Polyester 280 g/ m2.
Paréo Serviette. 50% Coton Organique/ 50% Polyester 280 g/ m2.
Omslag Handdoek. 50% Organisch Katoen/ 50% Polyester 280 g/ m2.

180 x 90 cm 20 Print Code: F(1), N(8), P



TERRY TOWEL



Yistal 6427

180 x 90 cm

Towel Pareo. 100% Organic Cotton 110 g/ m2.
Strandsarong. 100% Organische Baumwolle 110 g/ m2.
Paréo Serviette. 100% Coton Organique 110 g/ m2.
Omslag Handdoek. 100% Organisch Katoen 110 g/ m2.

180 x 90 cm 50 Print Code: F(1), N(8), P



TERRY TOWEL



Donell 20782

180 x 90 cm

Towel Pareo. 80% Cotton/ 20% Polyester 180 g/ m2.
 Strandsarong. 80% Baumwolle/ 20% Polyester 180 g/ m2.
 Paréo Serviette. 80% Coton/ 20% Polyester 180 g/ m2.
 Omslag Handdoek. 80% Katoen/ 20% Polyester 180 g/ m2.

180 x 90 cm 30 Print Code: F(1), N(8), P



Botari 20751

180 x 90 cm

Towel Pareo. 80% Cotton/ 20% Polyester 180 g/ m2.
 Strandsarong. 80% Baumwolle/ 20% Polyester 180 g/ m2.
 Paréo Serviette. 80% Coton/ 20% Polyester 180 g/ m2.
 Omslag Handdoek. 80% Katoen/ 20% Polyester 180 g/ m2.

180 x 90 cm 30 Print Code: F(1), N(8), P

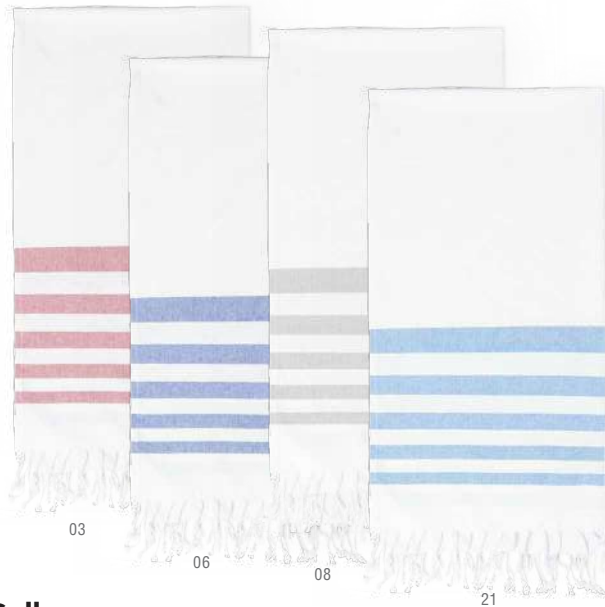

Sally 1184

170 x 90 cm

Towel Pareo. 100% Cotton 180 g/ m2.
 Strandsarong. 100% Baumwolle 180 g/ m2.
 Paréo Serviette. 100% Coton 180 g/ m2.
 Omslag Handdoek. 100% Katoen 180 g/ m2.

170 x 90 cm 30 Print Code: F(1), N(8), P



Vedant 1601

170 x 90 cm

Towel Pareo. 100% Cotton 180 g/ m2.
 Strandsarong. 100% Baumwolle 180 g/ m2.
 Paréo Serviette. 100% Coton 180 g/ m2.
 Omslag Handdoek. 100% Katoen 180 g/ m2.

170 x 90 cm 30 Print Code: F(1), N(8), P



New



Carey 20754

Drawstring Bag Pareo. 100% Recycled Cotton 170 g/ m².
Sarong Rucksack. 100% Recycling Baumwolle 170 g/ m².
Sac à Dos Paréo. 100% Coton Recyclé 170 g/ m².
Omstlag Rugzak. 100% Gerecycled Katoen 170 g/ m².

 180 x 90 cm  30  Print Code: F(1), N(8), O, P



Taylor 2636 Made in Europe

Towel Pareo. 60% Recycled Cotton/ 40% Polyester 250 g/ m².
Strandsarong. 60% Recycling Baumwolle/ 40% Polyester 250 g/ m².
Paréo Serviette. 60% Coton Recyclé/ 40% Polyester 250 g/ m².
Omstlag Handdoek. 60% Gerecycled Katoen/ 40% Polyester 250 g/ m².

 150 x 80 cm  35  Print Code: F(1), N(8), O, P



Yisper 2637 Made in Europe

Towel Pareo. 60% Recycled Cotton/ 40% Polyester 250 g/ m².
Strandsarong. 60% Recycling Baumwolle/ 40% Polyester 250 g/ m².
Paréo Serviette. 60% Coton Recyclé/ 40% Polyester 250 g/ m².
Omstlag Handdoek. 60% Gerecycled Katoen/ 40% Polyester 250 g/ m².

 150 x 80 cm  35  Print Code: F(1), N(8), O, P



Beach Mat XXL



08

13



21



06



CENTRAL HOLE FOR BEACH UMBRELLA

Buzzer 1181

Beach Mat. 100% Cotton 140 g/ m².
Strandmatte. 100% Baumwolle 140 g/ m².
Natte de Plage. 100% Coton 140 g/ m².
Strandmat. 100% Katoen 140 g/ m².

180 x 180 cm

180 x 180 cm 30 Print Code: F(1), N(8), P



Simbar 1182

Beach Mat. 100% Cotton 140 g/ m².
Strandmatte. 100% Baumwolle 140 g/ m².
Natte de Plage. 100% Coton 140 g/ m².
Strandmat. 100% Katoen 140 g/ m².

150 x 210 cm

150 x 210 cm 30 Print Code: F(1), N(8), P



08

RECYCLED COTTON TOWEL



TERRY TOWEL



TERRY TOWEL

Plivex 2638 Made in Europe

Towel. 65% Recycled Cotton/ 35% Polyester 330 g/ m².
Handtuch. 65% Recycling Baumwolle/ 35% Polyester 330 g/ m².
Serviette. 65% Coton Recyclé/ 35% Polyester 330 g/ m².
Handdoek. 65% Gerecycled Katoen/ 35% Polyester 330 g/ m².

150 x 80 cm

150 x 80 cm 25 Print Code: F(1), N(8), O, P



Flokyn 2639 Made in Europe

Towel. 65% Recycled Cotton/ 35% Polyester 330 g/ m².
Handtuch. 65% Recycling Baumwolle/ 35% Polyester 330 g/ m².
Serviette. 65% Coton Recyclé/ 35% Polyester 330 g/ m².
Handdoek. 65% Gerecycled Katoen/ 35% Polyester 330 g/ m².

150 x 80 cm

150 x 80 cm 25 Print Code: F(1), N(8), O, P





Reiven 5511

Beach Mat. PP.
Strandmatte. PP.
Natte de Plage. PP.
Strandmat. PP.

70 x 180 cm 50 Print Code: F(1)



SIZE XL



05



19

16

03

Buren 5704

Beach Mat. Laminated Non-Woven.
Strandmatte. Laminiertes Non-Woven.
Natte de Plage. T.N.T. Laminé.
Strandmat. Gelamineerd Non-Woven.

70 x 180 cm 100 / 50 Print Code: F(1), G(1)



07

SIZE XL



03



07

19

05

04

Kassia 5512

Beach Mat. PP.
Strandmatte. PP.
Natte de Plage. PP.
Strandmat. PP.

60 x 180 cm 50 Print Code: F(1)





19



07

05



03



02

Chaptan 1516

Beach Umbrella. Nylon. PVC Pouch.
Sonnenschirm. Nylon. PVC Etui.
Pare-Soleil. Nylon. Étui PVC.
Strandparasol. Nylon. PVC Zakje.



A



B



C

Nukel 6412



Beach Umbrella. Nylon. PVC Pouch.
Sonnenschirm. Nylon. PVC Etui.
Pare-Soleil. Nylon. Étui PVC.
Strandparasol. Nylon. PVC Zakje.

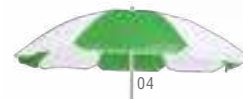

04

☞ Ø 150 cm ☞ 12 ☞ Print Code: H(1), N(8)

☞ Ø 150 cm ☞ 12 ☞ Print Code: H(1), N(8), R



Taner 3951

Beach Umbrella. Nylon. UV Protection. Nylon Pouch.
Sonnenschirm. Nylon. UV Schutz. Nylon Etui.
Parasol. Nylon. Protection Rayons UV. Étui Nylon.
Strandparasol. Nylon. UV Bescherming. Nylon Zakje.

☰ Ø 150 cm 📦 12 🏷️ Print Code: H(1), N(8)

Sandok 5490

Beach Umbrella. Nylon. Reclinable. UV Protection. Nylon Pouch.
Sonnenschirm. Nylon. Grössenverstellbar. UV Schutz. Nylon Etui.
Parasol. Nylon. Reclinable. Protection Rayons UV. Étui Nylon.
Strandparasol. Nylon. Verstellbare. UV Bescherming. Nylon Zakje.

☰ Ø 200 cm 📦 12 🏷️ Print Code: H(1), N(8)

Niobex 1120

Hammock. Canvas. Canvas Pouch.
Hängematte. Canvas. Canvas Etui.
Hamac. Toile. Étui Toile.
Hangmat. Canvas. Canvas Zakje.

190 x 80 cm 10
Print Code: G(1), K(8), N(8)



Medrus 1609

Holder. Wood/ Cotton. Foldable. 2 Positions.
Halter. Holz/ Baumwolle. Faltbar. 2 Positionen.
Support. Bois/ Coton. Pliable. 2 Positions.
Houder. Hout/ Katoen. Opvouwbaar. 2 Posities.

12.3 x 10.1 x 11 cm 200 / 50
Print Code: D(1), N(8)



Maretis 1608

Headrest. Wood/ Cotton. Foldable.
Kissen. Holz/ Baumwolle. Faltbar.
Coussin. Bois/ Coton. Pliable.
Kussen. Hout/ Katoen. Opvouwbaar.

25 x 15 x 15 cm 40
Print Code: E(1), L1, N(8)

Rinthia 1611

Chair. Wood/ Canvas. Foldable.
Stuhl. Holz/ Segeltuch. Faltbar.
Chaise. Bois/ Toile. Pliable.
Stoel. Hout/ Canvas. Opvouwbaar.

60.5 x 80 x 86.5 cm 2
Print Code: H(1), N(8)



Flentul 5489

Chair. Polyester 600D. Foldable. Polyester Pouch.
 Stuhl. Polyester 600D. Faltbar. Polyester Etui.
 Chaise. Polyester 600D. Pliable. Étui Polyester.
 Stoel. Polyester 600D. Opvouwbaar. Polyester Zakje.

45 x 70 x 45 cm 10 Print Code: H(1), N(8)



02 03 04



Coswel 1861

Chair. Polyester 600D. Foldable.
 Stuhl. Polyester 600D. Faltbar.
 Chaise. Polyester 600D. Pliable.
 Stoel. Polyester 600D. Opvouwbaar.

48 x 63 x 52 cm 6
 Print Code: H(1), N(8)



08 19 02



19

Xana 3571

Chair Cool Bag. Polyester 600D/ Aluminium. Foldable.
 Stuhl Kühltasche. Polyester 600D/ Aluminium. Faltbar.
 Chaise Glacière. Polyester 600D/ Aluminium. Pliable.
 Stoel-koeltas. Polyester 600D/ Aluminium. Opvouwbaar.

26.5 x 34.5 x 32 cm 20 Print Code: H(1), N(8)



03 02



New

Sagan 20459

Cool Bag Chair. Polyester 600D RPET/ PEVA.
 Stuhl Kühltasche. Polyester 600D RPET/ PEVA.
 Chaise Glacière. Polyester 600D RPET/ PEVA.
 Stoel-koeltas. Polyester 600D RPET/ PEVA.

31 x 42 x 35 cm 6 Print Code: N(8)





ZIPPER

Daniels 3311

Cool Bag. Polyester 190T/ Aluminium. Foldable.
Kühltasche. Polyester 190T/ Aluminium. Faltbar.
Glacière. Polyester 190T/ Aluminium. Pliable.
Koeltas. Polyester 190T/ Aluminium. Opvouwbaar.

45 x 36 x 9 cm 100 / 20
Print Code: G(1)



Pattel 1097

Cool Bag. Polyester 600D RPET/ PEVA.
Kühltasche. Polyester 600D RPET/ PEVA.
Glacière. Polyester 600D RPET/ PEVA.
Koeltas. Polyester 600D RPET/ PEVA.

48 x 52 x 16.5 cm 20 Print Code: G(1), N(8)



Yonner 6277

Thermal Picnic Basket. Polyester 600D/ Aluminium. Foldable.
Wärme Tasche. Polyester 600D/ Aluminium. Faltbar.
Sac Thermique. Polyester 600D/ Aluminium. Pliable.
Thermo-Tasje. Polyester 600D/ Aluminium. Opvouwbaar.

47 x 25 x 28 cm 20 Print Code: H(1), N(8)

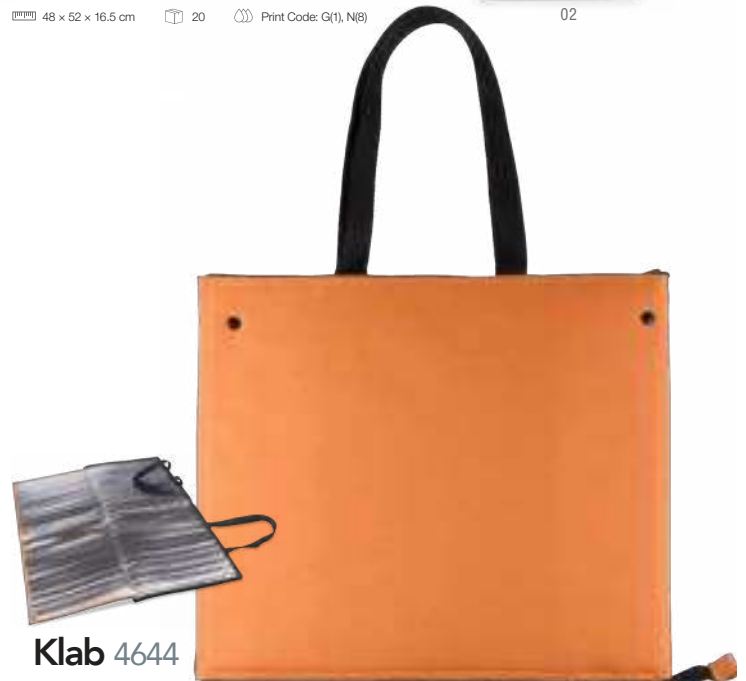

Klab 4644

Cool Bag. Polyester 600D/ Aluminium.
Kühltasche. Polyester 600D/ Aluminium.
Glacière. Polyester 600D/ Aluminium.
Koeltas. Polyester 600D/ Aluminium.

44 x 39 cm 50 Print Code: G(1), N(8)





Briant 1800

Thermal Picnic Basket. PP. Foldable.
 Picnic Wärme Tasche. PP. Fallbar.
 Sac Thermique Picnic. PP. Pliable.
 Picnic Thermo-Tasje. PP. Opvouwbaar.

47 x 24 x 29 cm 8 Print Code: K(1)



Vilan 20619

Cool Bag. PP. 4 L.
 Kühltasche. PP. 4 L.
 Glacière. PP. 4 L.
 Koeltas. PP. 4 L.

27 x 18.5 x 16 cm 4 Print Code: K(1)



Trixen 20618

Cool Bag. 100% Recycled Cotton/ PEVA.
 Kühltasche. 100% Recycling Baumwolle/ PEVA.
 Glacière. 100% Coton Recyclé/ PEVA.
 Koeltas. 100% Gerecycled Katoen/ PEVA.

30 x 18 x 14 cm 50 Print Code: G(1), N(8)



Linax 1100

Thermal Bag. 100% Cotton/ Laminated Jute/ Aluminium.
 Wärme Tasche. 100% Baumwolle/ Laminiertes Jutestoff/ Aluminium.
 Sac Thermique. 100% Coton/ Jute Laminé/ Aluminium.
 Thermo-Tasje. 100% Katoen/ Gelamineerd Jute/ Aluminium.

43 x 33 x 14 cm 50 / 10 Print Code: G(1), N(8)



06

Raxnal 1164

Bag. Laminated Jute/ Laminated Cotton.
Tasche. Laminiertes Jutestoff/ Laminiertes Baumwolle.
Sac. Jute Laminé/ Coton Laminé.
Tas. Gelamineerd Jute/ Gelamineerd Katoen.

48 x 35 x 15 cm 100 / 10
Print Code: F(1), N(8)



04

13



13

Cekon 5725

Bag. Laminated Jute/ Cotton.
Tasche. Laminiertes Jutestoff/ Baumwolle.
Sac. Jute Laminé/ Coton.
Tas. Gelamineerd Jute/ Katoen.

44.5 x 34 x 15 cm 50 / 10
Print Code: F(6), N(8)

NEW
COLOR

02

06

04



ZIPPER



Mandy 1264

Bag. Synthetic. With Inner Lining.
Tasche. Synthetisch. Mit Innenfutter.
Sac. Synthétique. Avec Doublure Intérieure.
Tas. Synthetisch. Met Voering aan de Binnenzijde.

45 x 40 cm 30
Print Code: F(1), Lt



Bedwey 1275

Bag. Straw/ Cotton.
Tasche. Stroh/ Baumwolle.
Sac. Paille/ Coton.
Tas. Stro/ Katoen.

44 x 41 x 11 cm 20
Print Code: F(1), Lt





New

Ivyx 20758

Bag, 100% Cotton 450 g/ m²/ Jute.
 Tasche, 100% Baumwolle 450 g/ m²/ Jutestoff.
 Sac, 100% Coton 450 g/ m²/ Jute.
 Tas, 100% Katoen 450 g/ m²/ Jutestoff.

📏 55 x 39 x 15 cm 📦 50 / 25 🏷️ Print Code: F(1), N(8), O, P



New

Tashi 20532

Beauty Bag, Laminated Jute/ PU.
 Kosmetik Tasche, Laminiertes Jutestoff/ PU.
 Nécessaire, Jute Laminé/ Similicuir.
 Toilettas, Gelamineerd Jute/ PU.

📏 29 x 17 cm 📦 300 / 50 🏷️ Print Code: F(1), L2



New

Moxia 20759

Bag, Straw/ PU.
 Tasche, Stroh/ PU.
 Sac, Paille/ Similicuir.
 Tas, Stro/ PU.

📏 47 x 30 x 24 cm 📦 20 🏷️ Print Code: F(1), L2



Tashi 20532

Moxia 20759



Farus 5726

Bag. Jute/ Cotton.
Tasche. Jutestoff/ Baumwolle.
Sac. Jute/ Coton.
Tas. Jute/ Katoen.

48 x 35 x 15 cm 100 / 10 Print Code: F(6), N(8)



13



07 11 02 19 21 05 03

Hintol 4883

Bag. Laminated Jute/ Cotton.
Tasche. Laminiertes Jutestoff/ Baumwolle.
Sac. Jute Laminé/ Coton.
Tas. Gelamineerd Jute/ Katoen.

44.5 x 35 x 14 cm 60 / 5 Print Code: F(1), N(8)



13



04 06 05

Rotin 6387

Bag. Laminated Jute/ Laminated Cotton.
Tasche. Laminiertes Jutestoff/ Laminiertes Baumwolle.
Sac. Jute Laminé/ Coton Laminé.
Tas. Gelamineerd Jute/ Gelamineerd Katoen.

39 x 31.5 x 16 cm 50 / 10 Print Code: F(6), N(8)



Bitalex 6388

Bag. Jute/ Cotton.
Tasche. Jutestoff/ Baumwolle.
Sac. Jute/ Coton.
Tas. Jute/ Katoen.

48 x 35 x 15 cm 50 / 10 Print Code: F(6), N(8), P



New

18

Belesi 20756

Bag. 100% Cotton 280 g/ m²/ Jute.
Tasche. 100% Baumwolle 280 g/ m²/ Jutestoff.
Sac. 100% Coton 280 g/ m²/ Jute.
Tas. 100% Katoen 280 g/ m²/ Jutestoff.

50 x 34 x 17.5 cm 50 / 25
Print Code: F(6), N(8), O, P



New

03

Dretan 20757

280 g/m²

Bag. 100% Cotton 280 g/ m².
Tasche. 100% Baumwolle 280 g/ m².
Sac. 100% Coton 280 g/ m².
Tas. 100% Katoen 280 g/ m².

53 x 38 x 17 cm 100 / 50
Print Code: F(6), N(8), O, P



New

09

Hitalax 21055

Bag. Cotton/ PU.
Tasche. Baumwolle/ PU.
Sac. Coton/ Similiticuir.
Tas. Katoen/ PU.

35 x 48 x 15 cm 100 / 25
Print Code: F(6), N(8), O, P



06

04



13

02

POCKET 06



23

22



280 g/m²

New

Hexa Fairtrade 20780

Bag. 100% Cotton 280 g/ m².
Tasche. 100% Baumwolle 280 g/ m².
Sac. 100% Coton 280 g/ m².
Tas. 100% Katoen 280 g/ m².

45 x 38 x 10.5 cm 50
Print Code: F(6), N(8), O, P

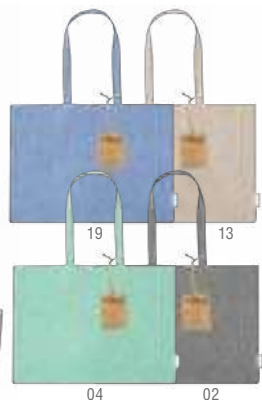

19

13

04

02

220 g/m²

Bonillo 20755

Bag. 100% Recycled Cotton 220 g/ m².
Tasche. 100% Recycling Baumwolle 220 g/ m².
Sac. 100% Coton Recyclé 220 g/ m².
Tas. 100% Gerecyclé Katoen 220 g/ m².

50 x 36 x 12 cm 100 / 50
Print Code: F(6), N(8), O, P



New

03

RECYCLED COTTON





220 g/m²

Kauly 1171

Bag. 100% Cotton 220 g/ m2.
Tasche. 100% Baumwolle 220 g/ m2.
Sac. 100% Coton 220 g/ m2.
Tas. 100% Katoen 220 g/ m2.

55 x 39 x 15 cm 50 / 10 Print Code: F(6), N(8), O, P

13

Holfox 5728

Bag. Polyester/ Cotton.
Tasche. Polyester/ Baumwolle.
Sac. Polyester/ Coton.
Tas. Polyester/ Katoen.

47 x 38 x 10 cm 100 / 10
Print Code: F(1), N(8)



03



• ZIPPER

Drexis 1598

Bag. Polyester. Beauty Bag Included.
Tasche. Polyester. Kosmetik Tasche Inklusive.
Sac. Polyester. Nécessaire Inclusive.
Tas. Polyester. Toilettes Inclusief.

47 x 34 x 12.5 cm 100 / 50 Print Code: G(1), N(8), R



• ZIPPER

Revile 1597

Bag. Polyester 600D. Beauty Bag Included.
Tasche. Polyester 600D. Kosmetik Tasche Inklusive.
Sac. Polyester 600D. Nécessaire Inclusive.
Tas. Polyester 600D. Toilettes Inclusief.

47 x 34 x 12.5 cm 50 Print Code: G(1), N(8)



13

06

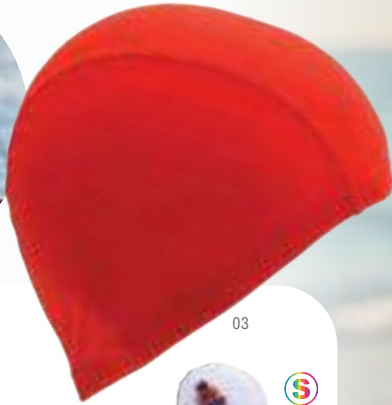

Micra 3572

Swim Hat. Polyester/ Spandex.
 Badekappe. Polyester/ Spandex.
 Bonnet de Piscine. Polyester/ Spandex.
 Zwermmuts. Polyester/ Spandex.

Consult. 400 / 50 Print Code: E(1), N(8), R



PillowBeach

OPAQUE

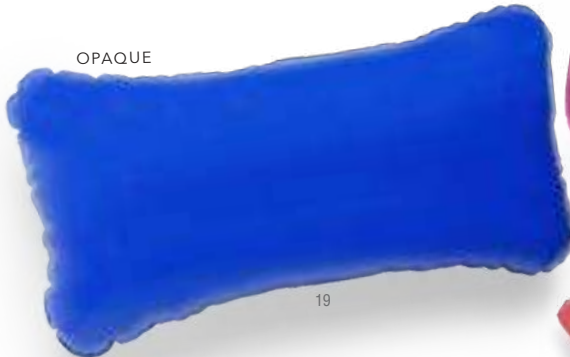

Cancún 9589

Pillow. PVC.
 Kissen. PVC.
 Coussin. PVC.
 Kussen. PVC.

30 x 7 x 15 cm 200 / 100 Print Code: F(1)

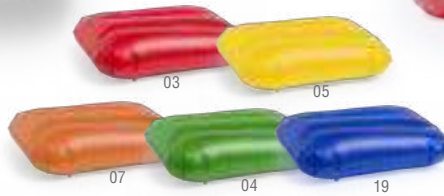

Egeo 3254

Pillow. PVC.
 Kissen. PVC.
 Coussin. PVC.
 Kussen. PVC.

28.5 x 7 x 19 cm 200 / 100 Print Code: F(1)



Blisit 5619

Pillow. PVC.
 Kissen. PVC.
 Coussin. PVC.
 Kussen. PVC.

30 x 12 x 15.5 cm 200 / 100 Print Code: F(1)

TRANSPARENT



THICKNESS
0,6 cm

Cupsol 4578

Beach Rackets. Wood.
Strand Schläger. Holz.
Raquette Plage. Bois.
Strand Rackets. Hout.

19 x 33 x 0,6 cm 36
Print Code: G(1)

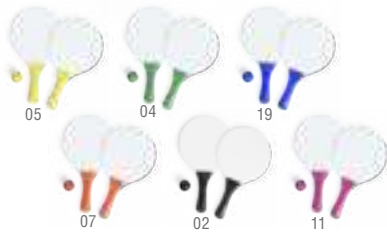

THICKNESS
0,8 cm



Kongal 5922

Beach Rackets. Wood.
Strand Schläger. Holz.
Raquette Plage. Bois.
Strand Rackets. Hout.

23,5 x 38 x 0,8 cm 24
Print Code: G(1)



Skippy 21169

Set. Racket PP. Beach Ball PVC.
Set. Schläger PP. Strandball PVC.
Set. Raquette PP. Ballon PVC.
Set. Racket PP. Strandbal PVC.

Consult. 300 / 50 Print Code: F(1), G(1)



THICKNESS
0,6 cm

Faluk 4804

Beach Rackets. Wood.
Strand Schläger. Holz.
Raquette Plage. Bois.
Strand Rackets. Hout.

19 x 33 x 0,6 cm 36
Print Code: G(1)



ⓘ
THICKNESS
0,6 cm



Bubbak 1099

Beach Rackets. Wood/ Cork. Cotton Pouch.
Strand Schläger. Holz/ Kork. Baumwolle Etui.
Raquette Plage. Bois/ Liège. Étui Coton.
Strand Rackets. Hout/ Kurk. Katoen Zakje.

19 x 33 x 0.6 cm 36 Print Code: G(1), L2, N(8)

ⓘ
THICKNESS
0,6 cm



Saiker 1279

Beach Rackets. Wood/ Wheat Straw/ PP.
Strand Schläger. Holz/ Weizenstroh/ PP.
Raquette Plage. Bois/ Paille de Blé/ PP.
Strand Rackets. Hout/ Tarwestro/ PP.

19 x 33 x 0.6 cm 36 Print Code: G(1), L2

CHESS,
DRAUGHTS
AND LUDO

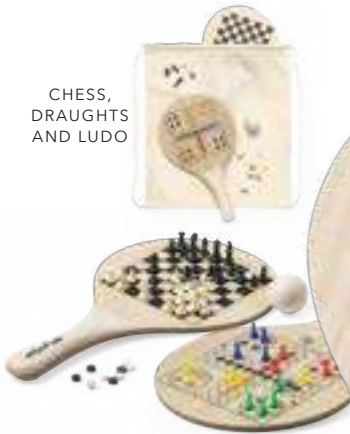

Pecter 1510

Beach Rackets. Wood/ Wheat Straw/ PP. 3
Games. Cotton Pouch.
Strand Schläger. Holz/ Weizenstroh/ PP. 3 Spiele.
Baumwolle Etui.
Raquette Plage. Bois/ Paille de Blé/ PP. 3 Jeux.
Étui Coton.
Strand Rackets. Hout/ Tarwestro/ PP. 3 Spelen.
Katoen Zakje.

19 x 33 x 0.6 cm 36
Print Code: G(1), L2, N(8)

ⓘ
THICKNESS
0,6 cm



New

ⓘ
THICKNESS
0,6 cm



Zaxia 20739

Sublimation Beach Rackets. Wood/ Wheat Straw/ PP.
Sublimations Strand Schläger. Holz/ Weizenstroh/ PP.
Raquette Plage Sublimation. Bois/ Paille de Blé/ PP.
Sublimatie Strand Rackets. Hout/ Tarwestro/ PP.

19 x 33 x 0.6 cm 36
Print Code: L2, R



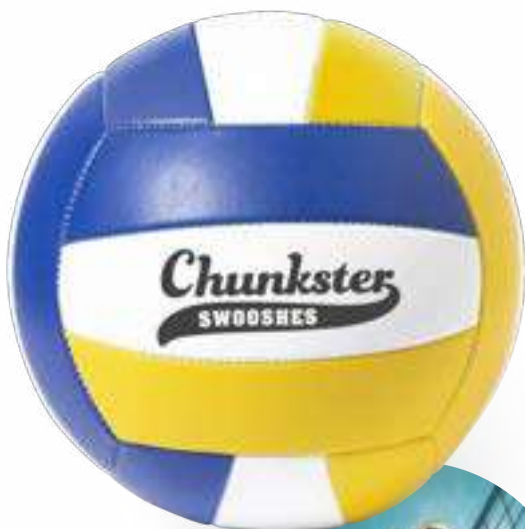

Lidok 6968

Ball. PU/ PVC. Size: 5.
Ball. PU/ PVC. Größe: 5.
Ballon. Similiticuir/ PVC. Taille: 5.
Voetbal. PU/ PVC. Maat: 5.

Consult. 40 Print Code: G(1)



Delko 4086

Ball. PU/ PVC. Size: 5.
Ball. PU/ PVC. Größe: 5.
Ballon. Similiticuir/ PVC. Taille: 5.
Voetbal. PU/ PVC. Maat: 5.

Consult. 40 Print Code: G(1)



Zubigol 3115

Goal Post. Nylon. Foldable. Polyester Pouch.
Strandfussballtor. Nylon. Faltbar. Polyester Etui.
Cage de Buts. Nylon. Pliable. Étui Polyester.
Doel. Nylon. Opvouwbaar. Polyester Zakje.

141 x 80 x 80 cm 20 Print Code: I(6)





05



New

03



04



Watson 9156

Frisbee. Polyester. Foldable.
Frisbie. Polyester. Faltbar.
Frisbee. Polyester. Pliable.
Frisbie. Polyester. Opvouwbaar.



Ø 24.5 cm 800 / 200 Print Code: E(1), F(1)



Girud 20332

Frisbee. TPR.
Frisbie. TPR.
Frisbee. TPR.
Frisbie. TPR.



Ø 18.3 x 0.2 cm 200 / 100 Print Code: E(1)

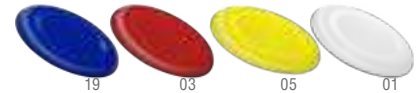

Girox 4579

Frisbee. PP.
Frisbie. PP.
Frisbee. PP.
Frisbie. PP.

Ø 23 x 1.8 cm 200 / 100 Print Code: E(1)

WHEAT STRAW



BAMBOO FIBRE



Croak 1509

Game. Wheat Straw/ PP.
Spiel. Weizenstroh/ PP.
Jeu. Paille de Blé/ PP.
Spel. Tarwestro/ PP.

Ø 15 x 2 cm 200 / 50 Print Code: E(1)



Ditul 6381

Frisbee. Bamboo Fibre/ PP.
Frisbie. Bambusfaser/ PP.
Frisbee. Fibre Bambou/ PP.
Frisbie. Bamboe Fibre/ PP.

Ø 22.8 x 2.5 cm 200 / 100 Print Code: E(1)



A

C

Darmon 1515

Beach Ball, PVC. Deflated Size: 37 cm. Inflated Size: 28 cm.
 Strandball, PVC. Entleerte Größe: 37 cm. Aufgepumpte Größe: 28 cm.
 Ballon, PVC. Dimensions Dégonflé: 37 cm. Gonflé: 28 cm.
 Strandbal, PVC. Onopgeblazen Maat: 37 cm. Opgeblazen Maat: 28 cm.

Consult. 200 / 100 Print Code: Consultar



B

ONE PLAIN SIDE
FOR PRINTING



03

05

07

19

01

02

BIG SIZE

Magno 3261

Beach Ball, PVC. Deflated Size: 47 cm. Inflated Size: 40 cm.
 Strandball, PVC. Entleerte Größe: 47 cm. Aufgepumpte Größe: 40 cm.
 Ballon, PVC. Dimensions Dégonflé: 47 cm. Gonflé: 40 cm.
 Strandbal, PVC. Onopgeblazen Maat: 47 cm. Opgeblazen Maat: 40 cm.

Consult. 200 / 100 Print Code: F(1), G(1)



Wembley 9576

Beach Ball, PVC. Deflated Size: 33 cm. Inflated Size: 25 cm.
 Strandball, PVC. Entleerte Größe: 33 cm. Aufgepumpte Größe: 25 cm.
 Ballon, PVC. Dimensions Dégonflé: 33 cm. Gonflé: 25 cm.
 Strandbal, PVC. Onopgeblazen Maat: 33 cm. Opgeblazen Maat: 25 cm.

Consult. 400 / 100 Print Code: F(1)



Portobello 8094

Beach Ball. PVC. Deflated Size: 37 cm. Inflated Size: 28 cm.
 Strandball. PVC. Entleerte Größe: 37 cm. Aufgepumpte Größe: 28 cm.
 Ballon. PVC. Dimensions Dégonflé: 37 cm. Gonflé: 28 cm.
 Strandbal. PVC. Onopgeblazen Maat: 37 cm. Opgeblazen Maat: 28 cm.

Consult. 200 / 100 Print Code: F(1), G(1)



BeachBall

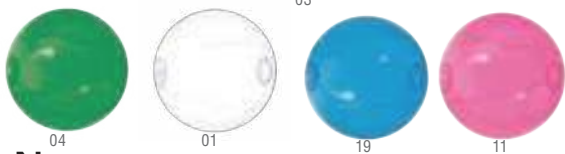

Nemon 4409

Beach Ball. PVC. Deflated Size: 37 cm. Inflated Size: 28 cm.
 Strandball. PVC. Entleerte Größe: 37 cm. Aufgepumpte Größe: 28 cm.
 Ballon. PVC. Dimensions Dégonflé: 37 cm. Gonflé: 28 cm.
 Strandbal. PVC. Onopgeblazen Maat: 37 cm. Opgeblazen Maat: 28 cm.

Consult. 200 / 100 Print Code: F(1), G(1)



Zeusty 5617

Beach Ball. PVC. Deflated Size: 37 cm. Inflated Size: 28 cm.
 Strandball. PVC. Entleerte Größe: 37 cm. Aufgepumpte Größe: 28 cm.
 Ballon. PVC. Dimensions Dégonflé: 37 cm. Gonflé: 28 cm.
 Strandbal. PVC. Onopgeblazen Maat: 37 cm. Opgeblazen Maat: 28 cm.

Consult. 200 / 100 Print Code: F(1), G(1)





05

BIG SIZE



19

01

03

Monvar 6602

Air Mattress. PVC. Special Folded for Printing.
 Luftmatratze. PVC. Spezielle Faltung für Einfachen Aufdruck.
 Matelas. PVC. Plîée Spécial pour Impression.
 Luchtbed. PVC. Speciaal Gevouwen voor Bedrukking.

75 x 185 x 25 cm 15 Print Code: H(1)



03



01

19

07

Pumper 9961

Air Mattress. PVC. Special Folded for Printing.
 Luftmatratze. PVC. Spezielle Faltung für Einfachen Aufdruck.
 Matelas. PVC. Plîée Spécial pour Impression.
 Luchtbed. PVC. Speciaal Gevouwen voor Bedrukking.

55 x 170 x 18 cm 25 Print Code: H(1)



19



03

07

01

NEW
COLOR

Wave 9417

Air Mattress. PVC.
 Luftmatratze. PVC.
 Matelas. PVC.
 Luchtbed. PVC.

31 x 68 x 10 cm 100 / 10 Print Code: H(1)



New

sun & Summer

975

SUN & SUMMER

01



Binsky 21170

Armchair. PVC/ Polyester. Special Folded for Printing.
Stuhl. PVC/ Polyester. Spezielle Faltung für Einfachen Aufdruck.
Fauteuil. PVC/ Polyester. Plîée Spécial pour Impression.
Armstoel. PVC/ Polyester. Speciaal Gevouwen voor Bedrukking.

72 x 155 x 25 cm 25 Print Code: H(1)

Tarxia 1612

Armchair. PVC/ Polyester. Special Folded for Printing.
Stuhl. PVC/ Polyester. Spezielle Faltung für Einfachen Aufdruck.
Fauteuil. PVC/ Polyester. Plîée Spécial pour Impression.
Armstoel. PVC/ Polyester. Speciaal Gevouwen voor Bedrukking.

80 x 110 x 18 cm 50 Print Code: H(1)



Donutk 5350

Air Mattress. PVC. Special Folded for Printing.
Luftmatratze. PVC. Spezielle Faltung für Einfachen Aufdruck.
Matelas. PVC. Plîée Spécial pour Impression.
Luchtbed. PVC. Speciaal Gevouwen voor Bedrukking.

Ø 107 x 30 cm 20 Print Code: H(1)



Reset 9963

Armchair. PVC. Special Folded for Printing.
Stuhl. PVC. Spezielle Faltung für Einfachen Aufdruck.
Fauteuil. PVC. Plîée Spécial pour Impression.
Armstoel. PVC. Speciaal Gevouwen voor Bedrukking.

70 x 45 x 70 cm 30 Print Code: H(1)





æ asiaexpress
DIRECT IMPORTS SERVICE

Fully customizable:
send your idea
and we'll make it
happen

Import
made
easy.



100%
customizable

import made easy



26 EVENTS







New

340 ml



MULTICOLOUR LIGHT

Armos 20631

Cup, PS, 340 ml. Multicolour Led Lights. 2 Light Modes, Fixed and Flashing. Button Batteries Included.
 Trinkbecher. PS. 340 ml. Mehrfarbige Led Lichter. 2 Lichtpositionen, Festes und Blinkendes. Knopfzellen Inklusive.
 Verre. PS. 340 ml. Lumières Led Multicolores. 2 Modes de Lumière, Fixe et Clignotante. Piles Bouton Incluses.
 Beker. PS. 340 ml. Meerkleurige Led Lichten. 2 Licht Posities, Vast en Knipperend. Knoopcel Batterijen Inclusief.

📏 Ø 8.2 x 11.4 cm 📦 50 🗑️ Print Code: D(1)



New

Stanfor 20629

Coaster. Multicolour Led Lights. 2 Light Modes, Fixed and Flashing. Adhesive. Button Batteries Included.
 Untersetzer. Mehrfarbige Led Lichter. 2 Lichtpositionen, Festes und Blinkendes. Haftend. Knopfzellen Inklusive.
 Sous-Verre. Lumières Led Multicolores. 2 Modes de Lumière, Fixe et Clignotante. Adhésif. Piles Bouton Incluses.
 Onderzetter. Meerkleurige Led Lichten. 2 Licht Posities, Vast en Knipperend. Klevend. Knoopcel Batterijen Inclusief.

📏 Ø 6 x 0.4 cm 📦 1000 / 100 🗑️ Print Code: C(4)



New

Vitaly 20630

Coaster. Acrylic. Multicolour Led Lights. 3 Light Modes, Fixed and Flashing. Button Batteries Included.
 Untersetzer. Acryl. Mehrfarbige Led Lichter. 3 Lichtpositionen, Festes und Blinkendes. Knopfzellen Inklusive.
 Sous-Verre. Acrylique. Lumières Led Multicolores. 3 Modes de Lumière, Fixe et Clignotante. Piles Bouton Incluses.
 Onderzetter. Acryl. Meerkleurige Led Lichten. 3 Licht Posities, Vast en Knipperend. Knoopcel Batterijen Inclusief.

📏 Ø 10 x 0.3 cm 📦 400 / 100 🗑️ Print Code: D(4), L2, W

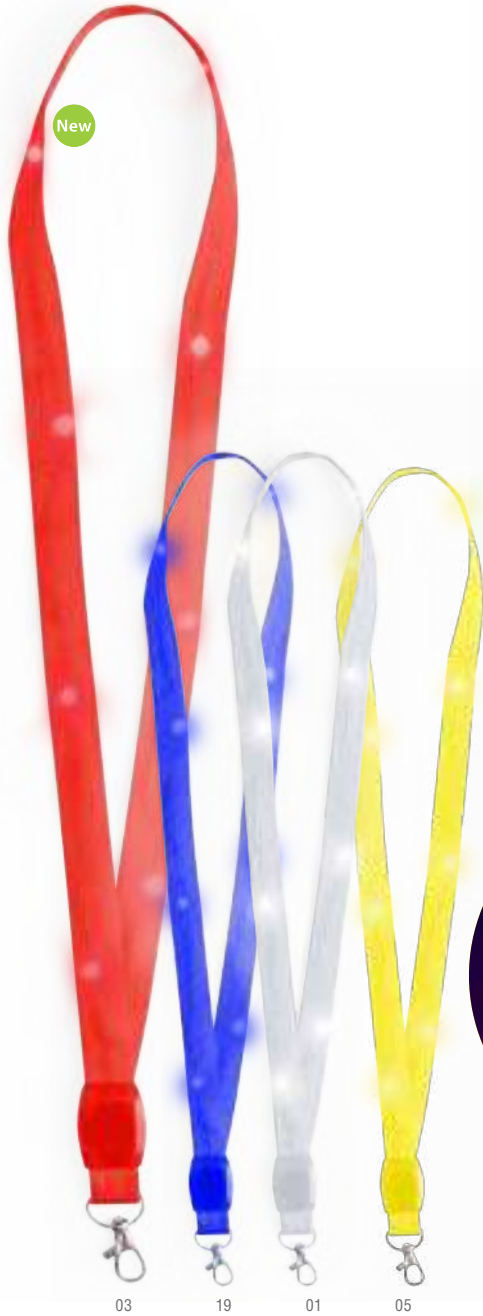

Wilou 20625

Lanyard. Polyester. 8 Leds. 3 Light Modes, Fixed and Flashing. Button Batteries Included.
 Schlüsselband. Polyester. 8 Leds. 3 Lichtpositionen, Festes und Blinkendes. Knopfzellen Inklusiv.
 Lanyard. Polyester. 8 Leds. 3 Modes de Lumière, Fixe et Clignotante. Piles Bouton Incluses.
 Lanyard. Polyester. 8 Leds. 3 Licht Posities, Vast en Knipperend. Knoopcel Batterijen Inclusief.

📏 2 x 50 cm 📦 300 / 50 🗣️ Print Code: D(1)

03

19

01

05

New



Sedora 20627

Bracelet. Silicone. Multicolour Led Lights. Button Batteries Included.
 Armband. Silikon. Mehrfarbige Led Lichten. Knopfzellen Inklusiv.
 Bracelet. Silicone. Lumières Led Multicolores. Piles Bouton Incluses.
 Armband. Siliconen. Meerkleurige Led Lichten. Knoopcel Batterijen Inclusief.

📏 Ø 7.5 x 2.4 cm 📦 400 / 100 🗣️ Print Code: C(4)

New



Xandar 20626

Pin. Multicolour Led Lights. 3 Light Modes, Fixed and Flashing. Button Batteries Included.
 Pin. Mehrfarbige Led Lichten. 3 Lichtpositionen, Festes und Blinkendes. Knopfzellen Inklusiv.
 Pin. Lumières Led Multicolores. 3 Modes de Lumière, Fixe et Clignotante. Piles Bouton Incluses.
 Speld. Meerkleurige Led Lichten. 3 Licht Posities, Vast en Knipperend. Knoopcel Batterijen Inclusief.

📏 Ø 5.1 x 1.5 cm 📦 500 / 50 🗣️ Print Code: D(4)

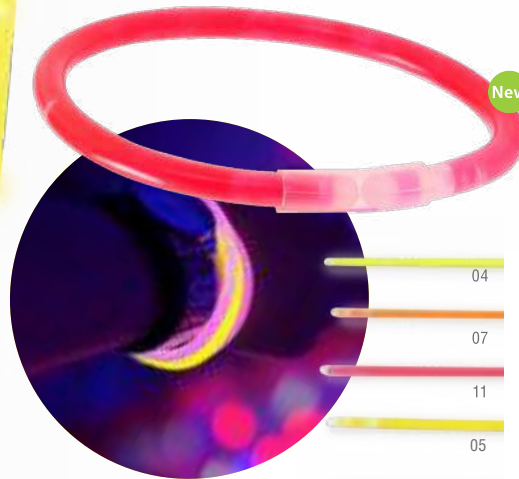

New

Vexa 20628

Glow Bracelet.
 Leuchtarmband.
 Bracelet Lumineux.
 Lichtgevende Armband.

📏 Ø 0.5 x 20 cm 📦 2000 / 100 🗣️ Print Code: A(1)

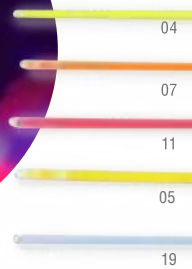

04

07

11

05

19

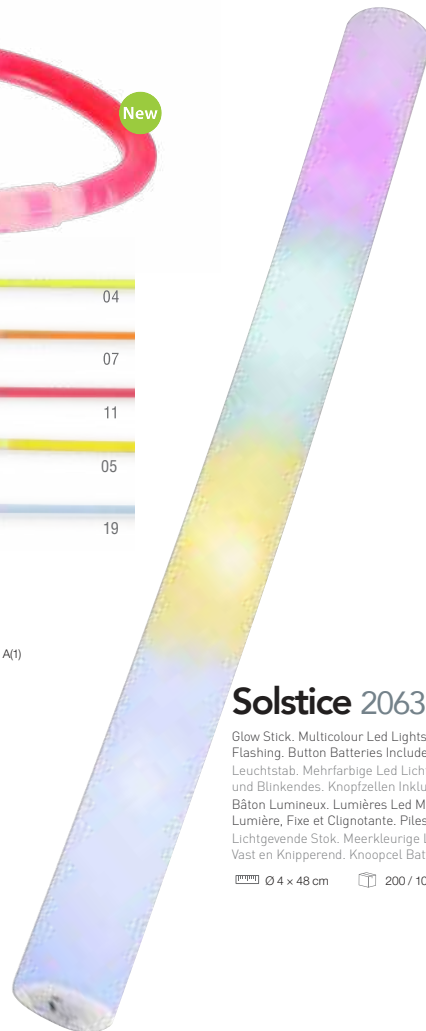

Solstice 20632

Glow Stick. Multicolour Led Lights. 3 Light Modes, Fixed and Flashing. Button Batteries Included.
 Leuchtstab. Mehrfarbige Led Lichten. 3 Lichtpositionen, Festes und Blinkendes. Knopfzellen Inklusiv.
 Bâton Lumineux. Lumières Led Multicolores. 3 Modes de Lumière, Fixe et Clignotante. Piles Bouton Incluses.
 Lichtgevende Stok. Meerkleurige Led Lichten. 3 Licht Posities, Vast en Knipperend. Knoopcel Batterijen Inclusief.

📏 Ø 4 x 48 cm 📦 200 / 100 🗣️ Print Code: D(1)

UNBREAKABLE

Security wristbands

EVENTS



03



21

UNBREAKABLE
SYNTHETIC

05



05F 21 19 11 08 07 05 04 02 01



17 01 02 03 04 05 07 08 11 19



01 02 03 04 05 07 19 22 17

IDEAL FOR PRINTING
10 PIECES

Events 3841

Bracelet. Tyvek® Material. One Size. Adult. Safety Catch.
Armband. Tyvek® Material. Einheitsgröße. Erwachsene. Sicherheitsverschluss.
Bracelet. Tyvek® Material. Taille Unique. Adulte. Fermeture Sécurité.
Armband. Tyvek® Material. Eén Maat. Volwassen. Veiligheidsluiting.

25.8 x 2.5 cm 20000 / 1000 Print Code: A(1)

IDEAL FOR PRINTING
10 PIECES

Fonten 1545

Bracelet. Synthetic. One Size. Adult. Safety Catch.
Armband. Synthetisch. Einheitsgröße. Erwachsene. Sicherheitsverschluss.
Bracelet. Synthétique. Taille Unique. Adulte. Fermeture Sécurité.
Armband. Synthetisch. Eén Maat. Volwassen. Veiligheidsluiting.

25 x 1.9 cm 10000 / 1000 Print Code: A(1)

IDEAL FOR PRINTING
10 PIECES

Ankaran 6203

Bracelet. Tyvek® Material. One Size. Adult. Safety Catch.
Armband. Tyvek® Material. Einheitsgröße. Erwachsene. Sicherheitsverschluss.
Bracelet. Tyvek® Material. Taille Unique. Adulte. Fermeture Sécurité.
Armband. Tyvek® Material. Eén Maat. Volwassen. Veiligheidsluiting.

25.5 x 1.9 cm 20000 / 1000 Print Code: A(1)



19



03



02 04 05 07

Multi 9096

Bracelet. PVC. Adjustable. Safety Catch.
Armband. PVC. Verstellbaar. Sicherheitsverschluss.
Bracelet. PVC. Ajustable. Fermeture Sécurité.
Armband. PVC. Aanpasbaar. Veiligheidsluiting.

24.3 x 2 cm 5000 / 100 Print Code: A(1)

IDEAL FOR PRINTING
10 PIECES

Sowel 6972

Bracelet. Tyvek® Material. One Size. Adult. Safety Catch.
Armband. Tyvek® Material. Einheitsgröße. Erwachsene. Sicherheitsverschluss.
Bracelet. Tyvek® Material. Taille Unique. Adulte. Fermeture Sécurité.
Armband. Tyvek® Material. Eén Maat. Volwassen. Veiligheidsluiting.

25.8 x 2.7 cm 20000 / 1000 Print Code: A(1)



19

03

05

IDEAL FOR PRINTING
10 PIECES

Mawi 3842

Bracelet. Tyvek® Material. One Size. Kids. Safety Catch.
Armband. Tyvek® Material. Einheitsgröße. Kinder. Sicherheitsverschluss.
Bracelet. Tyvek® Material. Taille Unique. Enfant. Fermeture Sécurité.
Armband. Tyvek® Material. Eén Maat. Kind. Veiligheidsluiting.

23 x 2.5 cm 20000 / 1000 Print Code: A(1)



19



Festak 6199

Bracelet. Polyester/ ABS. Adjustable. Safety Catch.
 Armband. Polyester/ ABS. Verstelbaar. Sicherheitsverschluss.
 Bracelet. Polyester/ ABS. Ajustable. Fermeture Sécurité.
 Armband. Polyester/ ABS. Aanpasbaar. Veiligheidsluiting.

35 x 1.5 cm 2000 / 500 Print Code: D(1)

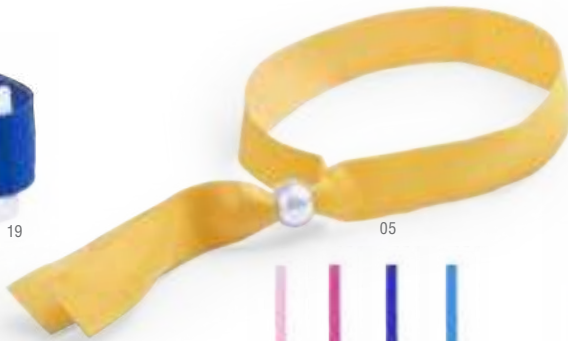

05



Mendol 5060

Bracelet. Polyester/ ABS. Adjustable.
 Armband. Polyester/ ABS. Verstelbaar.
 Bracelet. Polyester/ ABS. Ajustable.
 Armband. Polyester/ ABS. Aanpasbaar.

34.5 x 1.2 cm 2000 / 500 Print Code: D(1), R



04



Plasker 5061

Bracelet. Polyester/ ABS. Adjustable. Safety Catch.
 Armband. Polyester/ ABS. Verstelbaar. Sicherheitsverschluss.
 Bracelet. Polyester/ ABS. Ajustable. Fermeture Sécurité.
 Armband. Polyester/ ABS. Aanpasbaar. Veiligheidsluiting.

35 x 1.5 cm 2000 / 500 Print Code: D(1), R

COTTON

Bosgo 1542

Bracelet. 100% Cotton/ Bamboo. Adjustable. Safety Catch.
 Armband. 100% Baumwolle/ Bambus. Verstelbaar. Sicherheitsverschluss.
 Bracelet. 100% Coton/ Bambou. Ajustable. Fermeture Sécurité.
 Armband. 100% Katoen/ Bamboe. Aanpasbaar. Veiligheidsluiting.

35 x 1.5 cm 2000 / 500 Print Code: D(1), N(6)

RPET

Broch 6973

Bracelet. Polyester RPET/ Bamboo. Adjustable. Safety Catch.
 Armband. Polyester RPET/ Bambus. Verstelbaar. Sicherheitsverschluss.
 Bracelet. Polyester RPET/ Bamboe. Ajustable. Fermeture Sécurité.
 Armband. Polyester RPET/ Bamboe. Aanpasbaar. Veiligheidsluiting.

35 x 1.5 cm 2000 / 500 Print Code: D(1), R

NATURAL CORK

Bayala 6974

Bracelet. Cork. Adjustable. Safety Catch.
 Armband. Kurk. Verstelbaar. Sicherheitsverschluss.
 Bracelet. Liège. Ajustable. Fermeture Sécurité.
 Armband. Kurk. Aanpasbaar. Veiligheidsluiting.

25 x 1.5 cm 5000 / 1000 Print Code: A(1)

Special SUBLIMATION



Nopak 5454

Sublimation Lanyard, Polyester.
Sublimations Schlüsselband, Polyester.
Lanyard Sublimation, Polyester.
Sublimatie Lanyard, Polyester.

2.5 x 50 cm 500 / 100 Print Code: R



Waylen 5852

Sublimation Bracelet, Polyester.
Sublimations Armband, Polyester.
Bracelet Sublimation, Polyester.
Sublimatie Armband, Polyester.

30 x 1.5 cm Print Code: R



Lerop 2598

Sublimation Lanyard, Polyester.
Sublimations Schlüsselband, Polyester.
Lanyard Sublimation, Polyester.
Sublimatie Lanyard, Polyester.

2.5 x 100 cm 500 Print Code: R



Special Events

985

EVENTS



Abanda 2747

Plate, PP.
Teller, PP.
Assiette, PP.
Bord, PP.

 Ø 15 x 1.8 cm  190  Print Code: B(1)



Grisen 2761



Plate, PP.
Teller, PP.
Assiette, PP.
Bord, PP.

 Ø 19 x 1.5 cm  100  Print Code: B(1)



Hisnak 2762

Plate, PP.
Teller, PP.
Assiette, PP.
Bord, PP.

 19.5 x 2.3 x 19.5 cm  100  Print Code: B(1)



REUSABLE CUPS

Special Events



Hesun 2760

Cup. PP. 1,2 L.
Trinkbecher. PP. 1,2 L.
Verre. PP. 1,2 L.
Beker. PP. 1,2 L.

Ø 10,7 x 19 cm 400
Print Code: C(1)

12 L



Raxon 2751

Cup. PP. 600 ml.
Trinkbecher. PP. 600 ml.
Verre. PP. 600 ml.
Beker. PP. 600 ml.

Ø 8,8 x 12 cm 450 / 25
Print Code: C(1)

600 ml



Ginbert 2494

Cup. PP. 500 ml.
Trinkbecher. PP. 500 ml.
Verre. PP. 500 ml.
Beker. PP. 500 ml.

Ø 9,2 x 11,6 cm 500 / 25
Print Code: C(1)

500 ml



Colorbert 2752

Cup. PP. 500 ml.
Trinkbecher. PP. 500 ml.
Verre. PP. 500 ml.
Beker. PP. 500 ml.

Ø 8,9 x 11 cm 450 / 25
Print Code: C(1)

500 ml



Combi 2753

Cup. PP. 450 ml.
Trinkbecher. PP. 450 ml.
Verre. PP. 450 ml.
Beker. PP. 450 ml.

Ø 8 x 13,3 cm 500 / 25
Print Code: C(1)

450 ml



Cuvak 2754

Cup. PP. 400 ml.
Trinkbecher. PP. 400 ml.
Verre. PP. 400 ml.
Beker. PP. 400 ml.

Ø 8 x 11,5 cm 500 / 25
Print Code: C(1)

400 ml



Tanpil 2759

Cup. PP. 330 ml.
Trinkbecher. PP. 330 ml.
Verre. PP. 330 ml.
Beker. PP. 330 ml.

Ø 7,8 x 7,8 cm 320
Print Code: C(1)

330 ml



Chiquito 2755

Cup. PP. 220 ml.
Trinkbecher. PP. 220 ml.
Verre. PP. 220 ml.
Beker. PP. 220 ml.

Ø 7,9 x 5,5 cm 480
Print Code: C(1)

220 ml



Chupito 2756

Cup. PP. 35 ml.
Trinkbecher. PP. 35 ml.
Verre. PP. 35 ml.
Beker. PP. 35 ml.

Ø 3,9 x 4,6 cm 1000
Print Code: B(1)

35 ml



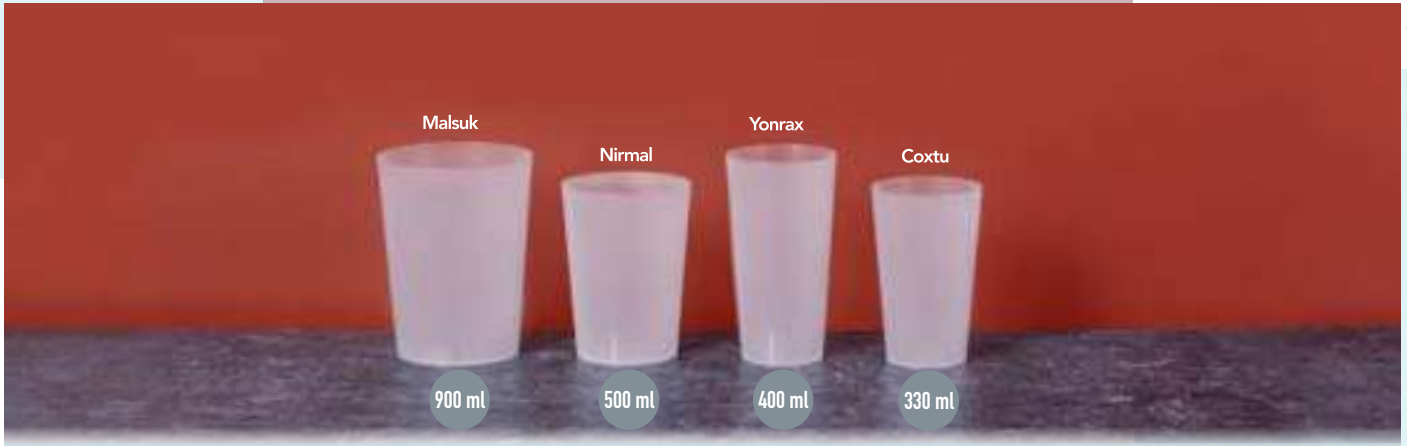

Special Events

Malsuk 2757

Cup, PP, 900 ml.
Trinkbecher, PP, 900 ml.
Verre, PP, 900 ml.
Beker, PP, 900 ml.

📏 Ø 10.5 x 13.6 cm 📦 150
♻️ Print Code: C(1)

900 ml



Nirmal 2554

Cup, PP, 500 ml.
Trinkbecher, PP, 500 ml.
Verre, PP, 500 ml.
Beker, PP, 500 ml.

📏 Ø 8.7 x 11.8 cm 📦 384 / 16 ♻️ Print Code: C(1)

500 ml



Yonrax 2555

Cup, PP, 400 ml.
Trinkbecher, PP, 400 ml.
Verre, PP, 400 ml.
Beker, PP, 400 ml.

📏 Ø 7.5 x 14 cm 📦 490 / 14 ♻️ Print Code: C(1)

400 ml



Coxtu 2758

Cup, PP, 330 ml.
Trinkbecher, PP, 330 ml.
Verre, PP, 330 ml.
Beker, PP, 330 ml.

📏 Ø 7 x 12 cm 📦 360 ♻️ Print Code: C(1)

330 ml





Neck 8780

Lanyard. Polyester.
Schlüsselband. Polyester.
Lanyard. Polyester.
Lanyard. Polyester.

📏 2 x 50 cm 📦 800 / 100 🖨️ Print Code: G(1), N(8), R



Tusca 20633

Cup Holder Cltp. PP.
Getränkhalter-Klammer. PP.
Pince Porte-Gobelet. PP.
Bekerhouderklcm. PP.

📏 1.6 x 2.2 x 2.2 cm 📦 2000 🖨️ Print Code: A(1)

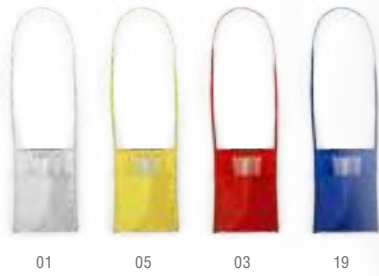

01 05 03 19

Yobok 4521

Multipurpose Bag. Non-Woven.
 Mehrzwecktasche. Non-Woven.
 Fourre-Tout. T.N.T.
 Multifunctioneel Tasje. Non-Woven.

17 x 22 x 6.2 cm 500 / 100
 Print Code: E(1)



02

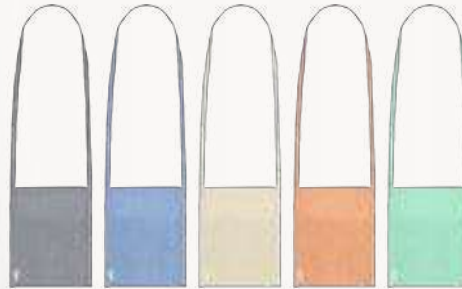

02 19 13 07 04

Wisy 20634

Multipurpose Bag. 100% Recycled Cotton.
 Mehrzwecktasche. 100% Recycling Baumwolle.
 Fourre-Tout. 100% Coton Recyclé.
 Multifunctioneel Tasje. 100% Gerecycled Katoen.

18 x 22 cm 400 / 50 Print Code: E(1), N(8)

New



03

polyester



03



SUBLIMATION

01

02

19

05

04

Frinly 6595

Lanyard Cup Holder. Polyester/ Silicone.
 Schlüsselband Getränkehalter. Polyester/ Silikon.
 Lanyard Porte Verre. Polyester/ Silicone.
 Lanyard Getränkehalter. Polyester/ Siliconen.

6 x 45 cm 800 / 100 Print Code: G(1), N(8), R



cotton



Felin 1541

Lanyard Cup Holder. 100% Cotton/ Silicone.
 Schlüsselband Getränkehalter. 100% Baumwolle/ Silikon.
 Lanyard Porte Verre. 100% Coton/ Silicone.
 Lanyard Getränkehalter. 100% Katoen/ Siliconen.

6 x 45 cm 800 / 100 Print Code: G(1), N(8)



Suju 20636

Pin.
Pin.
Pin.
Speld.

Ø 4.4 cm 2000 / 100 Print Code: B(1), W



Varek 20637

Pin.
Pin.
Pin.
Speld.

Ø 6 cm 1000 / 100 Print Code: B(1), W



04



Turmi 3741

Pin.
Pin.
Pin.
Speld.

Ø 3 cm 4000 / 200 Print Code: B(1)

Special doming

minimum 300 pcs
Full colour printing
Doming included
set up cost not included.



Batler 4607

Pin. Metal.
Pin. Metall.
Pin. Métal.
Speld. Metaal.

Consult. 1000 / 500 Print Code: Consult.



Formix 4762

Pin.
Pin.
Pin.
Speld.

Consult. 5000 / 100 Print Code: Consult.



Digital printing



Zamur 4234

Glasses.
Brille.
Lunettes.
Bril.

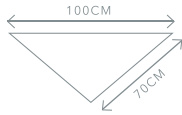
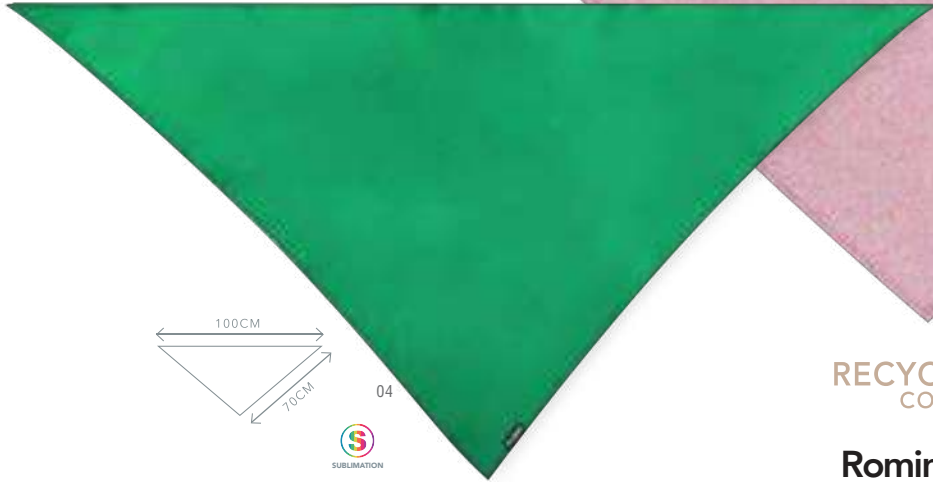

Consult. 300 / 10 Print Code: D(4), W

RPET  New



Wasat 20635

Neckerchief. Polyester 190T RPET.
Halstuch. Polyester 190T RPET.
Foulard. Polyester 190T RPET.
Bandana. Polyester 190T RPET.

 100 x 70 cm  1000 / 10
 Print Code: F(1), N(8), R



RECYCLED COTTON 

Romin 20700

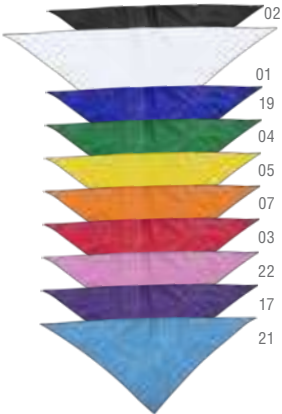
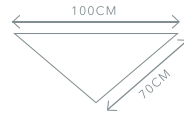

Neckerchief. 100% Recycled Cotton.
Halstuch. 100% Recycling Baumwolle.
Foulard. 100% Coton Recyclé.
Bandana. 100% Gerecyclted Kätoen.

 100 x 70 cm  200 / 50
 Print Code: F(8), N(8)



Plus 3029

Neckerchief. Polyester 170T.
Halstuch. Polyester 170T.
Foulard. Polyester 170T.
Bandana. Polyester 170T.

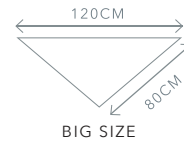
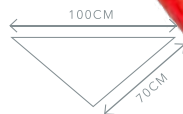

 100 x 70 cm  1000 / 10
 Print Code: F(1), N(8), R



Kozma 4834

2in1
MULTI
FUNCTION

Neckerchief Wrap. Polyester 170T.
Halstuch. Polyester 170T.
Foulard Tissu. Polyester 170T.
Bandana. Polyester 170T.

 120 x 80 cm  1000 / 10
 Print Code: F(1), N(8), R

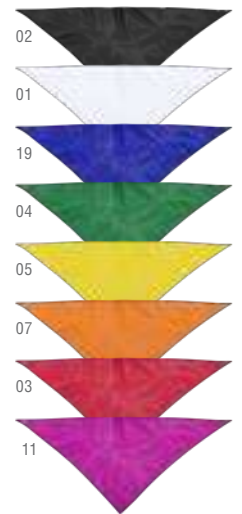



Sporter 3316

Vest. Polyester 190T. One Size. Adult.
 Weste. Polyester 190T. Einheitsgröße. Erwachsene.
 Chasuble. Polyester 190T. Taille Unique. Adulte.
 Vest. Polyester 190T. Eén Maat. Volwassen.

52 x 63 cm 300 / 25 Print Code: F(1)



03

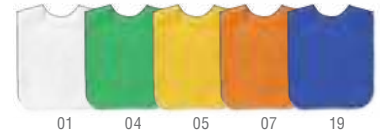

Cambex 4531

Vest. Non-Woven. One Size. Adult.
 Weste. Non-Woven. Einheitsgröße. Erwachsene.
 Chasuble. T.N.T. Taille Unique. Adulte.
 Vest. Non-Woven. Eén Maat. Volwassen.

53 x 66 cm 200 / 25 Print Code: F(1)



Rolof 4835

Pennant Flag. Polyester 170T.
 Fähnchen. Polyester 170T.
 Fanion. Polyester 170T.
 Vlag op Stok. Polyester 170T.

20 x 13.5 cm 2000 / 10 Print Code: D(1), R



04



Dambor 6200

Flag. Polyester 170D.
 Fahne. Polyester 170D.
 Drapeau. Polyester 170D.
 Vlag. Polyester 170D.

100 x 70 cm 200 / 10 Print Code: G(1), R



07



Yopet 4649

Whistle.
 Pfeife.
 Sifflet.
 Fluitje.

1.9 x 5 x 2.4 cm 1000 / 250 Print Code: C(1)



Colour 9768

Painting Set.
Fan Schminkset.
Set Peinture.
Schilder Set.

9.2 x 5 x 0.9 cm 400 / 50 Print Code: D(4)



Stick 9075

Cheering Sticks. LDPE. Reusable. Inflating Valve Included.
Klatschstange. LDPE. Wiederverwendbar. Inflation Ventil Inklusive.
Tap Tap. LDPE. Réutilisable. Valve pour Gonfler Incluse.
Cheering Sticks. LDPE. Herbruikbaar. Opblaasrietje Inclusief.

60 x 10 cm 500 / 25 Print Code: G(1)



Viorix 20638

Cheering Sticks. RPET. Reusable. Inflating Valve Included.
Klatschstange. RPET. Wiederverwendbar. Inflation Ventil Inklusive.
Tap Tap. RPET. Réutilisable. Valve pour Gonfler Incluse.
Cheering Sticks. RPET. Herbruikbaar. Opblaasrietje Inclusief.

60 x 10 cm 500 / 25 Print Code: F(1)



Rostel 6970

Cushion. Non-Woven. Padded.
Kissen. Non-Woven. Gepolstert.
Coussin. T.N.T. Rembourré.
Kussen. Non-Woven. Gewatteerd.

31 x 31 cm 50 Print Code: F(1)

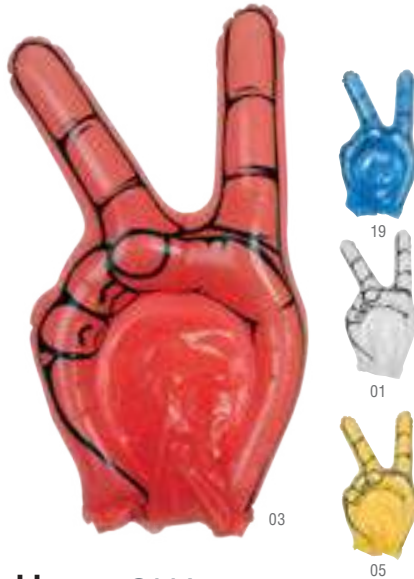

Hogan 9664

Animation Hand. LDPE. Reusable. Inflating Valve Included.
Klatschhand. LDPE. Wiederverwendbar. Inflation Ventil Inklusive.
Main Animation. LDPE. Réutilisable. Valve pour Gonfler Incluse.
Animatie-Hand. LDPE. Herbruikbaar. Opblaasrietje Inclusief.

33.5 x 57 cm 500 / 50 Print Code: G(1)



Zacky 6066

Animation Hand. EVA.
Klatschhand. EVA.
Main Animation. EVA.
Animatie-Hand. EVA.

25 x 50 cm 200 / 20 Print Code: F(1)

New



19



04



SUITABLE FOR ALL MOBILES

03



Seibly 20156

Lanyard. Silicone/ Polyester.
Schlüsselband. Silikon/ Polyester.
Lanyard. Silicone/ Polyester.
Lanyard. Siliconen/ Polyester.

📏 7 x 60 cm 📦 300 / 50 🖨️ Print Code: G(1), L1



02

New



07

11

19



03

01

04

05

Naomi 20242

Holder Bracelet. Silicone.
Halter Armband. Silikon.
Bracelet Support. Silicone.
Houder Armband. Siliconen.

📏 Ø 8.7 x 0.7 cm 📦 500 / 100 🖨️ Print Code: E(1), L1



117

08

02



06



19

01

02

03

Veltux 5638

Lanyard. Silicone.
Schlüsselband. Silikon.
Lanyard. Silicone.
Lanyard. Siliconen.

📏 7 x 58 cm 📦 300 / 50 🖨️ Print Code: G(1), L1

Landry 1838

Multipurpose Bag. Polyester 600D RPET.
Mehrzwecktasche. Polyester 600D RPET.
Fourre-Tout. Polyester 600D RPET.
Multifunctioneel Tasje. Polyester 600D RPET.

📏 11.5 x 19.5 x 2 cm 📦 200 / 50 🖨️ Print Code: F(1), N(8), R



New

Festival 20542

Kit. PP. 10 Accessoires.
 Kit. PP. 10 Teile.
 Kit. PP. 10 Accessoires.
 Kit. PP. 10 Accessoires.

5 x 9.5 x 2.5 cm 100
 Print Code: D(1)



New

35 ml

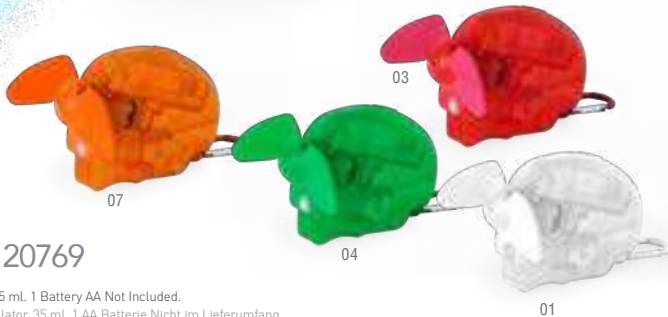

Bluco 20769

Vaporizer Fan. 35 ml. 1 Battery AA Not Included.
 Zerstäuber Ventilator. 35 ml. 1 AA Batterie Nicht im Lieferumfang.
 Ventilateur Vaporisateur. 35 ml. 1 Pile AA Non Inclusive.
 Sproeier Ventilator. 35 ml. 1 Batterij AA Niet Inclusief.

10 x 7 x 2.6 cm 100 / 50 Print Code: D(1)



Dayane 1726

Fan. 2 Modes. 3 Batteries AAA Not Included.
 Ventilator. 2 Positionen. 3 AAA Batterien Nicht im Lieferumfang.
 Ventilateur. 2 Modes. 3 Piles AAA Non Inclusive.
 Ventilator. 2 Posities. 3 Batterijen AAA Niet Inclusief.

8 x 17.5 x 2.5 cm 100 / 50 Print Code: D(4)

EVENTS



Neck 8780

Lanyard. Polyester.
Schlüsselband. Polyester.
Lanyard. Polyester.
Lanyard. Polyester.

2 x 50 cm 800 / 100 Print Code: G(1), N(8), R



Loriet 1544

Lanyard. Polyester RPET.
Schlüsselband. Polyester RPET.
Lanyard. Polyester RPET.
Lanyard. Polyester RPET.

2 x 50 cm 800 / 100 Print Code: G(1), N(8), R

Neck 8780

16

Loriet 1544

08

Kunel 6415

07

Kappin 6102

19

SAFETY CATCH



Kunel 6415

Lanyard. Polyester.
Schlüsselband. Polyester.
Lanyard. Polyester.
Lanyard. Polyester.

2 x 55 cm 600 / 100 Print Code: G(1), N(8), R



Kappin 6102

Lanyard. Polyester. Safety Catch.
Schlüsselband. Polyester. Sicherheitsverschluss.
Lanyard. Polyester. Fermeture Sécurité.
Lanyard. Polyester. Veiligheidsluiting.

2 x 50 cm 800 / 100 Print Code: G(1), N(8), R





ID Badget



Solip 4824

Id Badge, PVC.
Namensschild, PVC.
Badge, PVC.
Id Badge, PVC.



Consult. 1000 / 100 Print Code: C(1)

Skoll 20639

Id Badge, PVC.
Namensschild, PVC.
Badge, PVC.
Id Badge, PVC.

11,3 x 18 cm 1000 / 200 Print Code: C(1)



ID BADGE INCLUDED

19



Maes 3709

Id Badge Lanyard, Polyester/ PVC.
Namensschild Schlüsselband, Polyester/ PVC.
Lanyard Porte-Badge, Polyester/ PVC.
Badge Lanyard, Polyester/ PVC.

11 x 58 cm 1000 / 100 Print Code: G(1), D(1)



Ifem 9169

Id Badge, PVC.
Namensschild, PVC.
Badge, PVC.
Id Badge, PVC.

10 x 9 cm 2000 / 200 Print Code: C(1)



Alter 4344

Id Badge, PVC.
Namensschild, PVC.
Badge, PVC.
Id Badge, PVC.

11 x 9,5 cm 1000 / 100 Print Code: C(1)

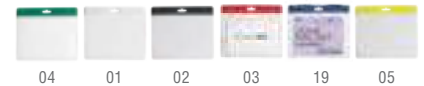



Bindel 3726

Id Badge. Aluminium.
Namensschild. Aluminium.
Badge. Aluminium.
Id Badge. Aluminium.

7 x 2.5 x 0.4 cm 1000 / 40 Print Code: C(4), L1



Upsin 5516

Id Badge.
Namensschild.
Badge.
Id Badge.

6.8 x 3.4 x 0.9 cm 1000 / 100 Print Code: C(4), L1



Venkal 5517

Id Badge. Aluminium.
Namensschild. Aluminium.
Badge. Aluminium.
Id Badge. Aluminium.

7 x 2.5 x 0.7 cm 1000 / 100 Print Code: C(4)



Sartal 6955

Id Badge. Cork.
Namensschild. Kork.
Badge. Liège.
Id Badge. Kurk.

7 x 2.5 x 1 cm 2000 / 200 Print Code: C(4), L1



ID Badgget

Rollup & Banner

Drentox 5067

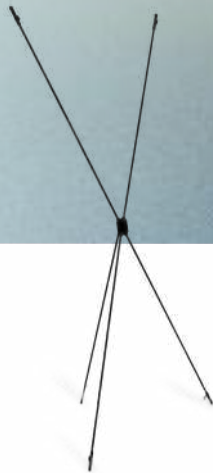

Lessep 5066

X-Banner. Steel and Fibreglass. Non-Woven Pouch.
 X-Banner. Stahl und Fiberglass. Non-Woven Etui.
 X-Banner. Acier et Fibre de Verre. Étui T.N.T.
 X-Banner. Staal en Glasvezel. Non-Woven Zakje.

60 x 160 cm 50 Print Code: Consult.

Drentox 5067

Roll Up. Aluminium. Polyester Pouch.
 Roll Up. Aluminium. Polyester Etui.
 Roll Up. Aluminium. Étui Polyester.
 Roll Up. Aluminium. Polyester Zakje.

85 x 208 cm 6 Print Code: Consult.



27 RAIN & COLD





**WINTER
COLD
RAIN**

1002

RAIN & COLD



New



Sandy 20160

Umbrella. Polyester 190T. Metal Ribs. 21". Polyester Pouch.
Regenschirm. Polyester 190T. Metall Rippen. 21". Polyester Etui.
Parapluie. Polyester 190T. Tiges Métal. 21". Étui Polyester.
Paraplu. Polyester 190T. Ribben Metaal. 21". Polyester Zakje.

☒ Ø 96 cm ☒ 60 ☒ Print Code: G(1), N(8), R



02



Ziant 4673

Umbrella. Polyester 190T. Metal Ribs. 21". Polyester Pouch.
Regenschirm. Polyester 190T. Metall Rippen. 21". Polyester Etui.
Parapluie. Polyester 190T. Tiges Métal. 21". Étui Polyester.
Paraplu. Polyester 190T. Ribben Metaal. 21". Polyester Zakje.

☒ Ø 96 cm ☒ 60 ☒ Print Code: G(1), N(8), R



01



RPET & STAINLESS STEEL Cork

New



550 ml

Neolux 21121



Set. Umbrella Pongee 190T. Fibreglass Ribs. 21". Windproof. Cork Handle. Pongee RPET Pouch. Insulated Bottle Recycled Stainless Steel/ Cork. 550 ml.

Set. Regenschirm Pongee 190T. Fibreglass Rippen. 21". Antiwindsystem. Kork Griff. Pongee RPET Etui. Wärme Flasche Recycling Rostfreier Stahl/ Kork. 550 ml.

Set. Parapluie Pongée 190T. Tiges Fibre de Verre. 21". Système Anti-Vent. Poignée Liège. Étui Pongee RPET. Bidon Thermique Acier Inox Recyclé/ Liège. 550 ml.

Set. Paraplu Pongee 190T. Glasvezel Ribben. 21". Windbestendig. Kurk Handvat. Pongee RPET Zakje. Thermoskan-Fles Gerecycled Roestvrij Staal/ Kurk. 550 ml.

☒ 37.8 x 9.6 x 18.4 cm ☒ 10 ☒ Print Code: F(1), G(1), L2, N(8)





Barbra 20237

Umbrella, Pongee 190T RPET, Fibreglass Ribs, 21". Windproof, Pongee RPET Pouch.
 Regenschirm, Pongee 190T RPET, Fiberglass Rippen, 21". Antiwindsystem, Pongee RPET Etui.
 Parapluie, Pongée 190T RPET, Tiges Fibre de Verre, 21". Système Anti-Vent, Étui Pongee RPET.
 Paraplu, Pongee 190T RPET, Glasvezel Ribben, 21". Windbestendig, Pongee RPET Zakje.

📏 97 x 30 cm 📖 30 🗑️ Print Code: G(1), L2, N(8)



Claris 20236

Umbrella, Pongee 190T RPET, Fibreglass Ribs, 21". Windproof, Pongee RPET Pouch.
 Regenschirm, Pongee 190T RPET, Fiberglass Rippen, 21". Antiwindsystem, Pongee RPET Etui.
 Parapluie, Pongée 190T RPET, Tiges Fibre de Verre, 21". Système Anti-Vent, Étui Pongee RPET.
 Paraplu, Pongee 190T RPET, Glasvezel Ribben, 21". Windbestendig, Pongee RPET Zakje.

📏 98 x 25.5 cm 📖 30 🗑️ Print Code: G(1), N(8)

RPET & RECYCLED STAINLESS STEEL



New

Gregory 20238

Set, Umbrella Pongee 190T, Fiberglass Ribs, 21", Windproof, Pongee RPET Pouch. Insulated Bottle Recycled Stainless Steel, 500 ml. Notepad Polyester 300D RPET, Hard Cover, 80 Sheets. Polyester 300D RPET Pen Included.
 Set, Regenschirm Pongee 190T, Fiberglass Rippen, 21", Antiwindsystem, Pongee RPET Etui. Wärme Flasche Recycling Rostfreier Stahl, 500 ml. Notizblock Polyester 300D RPET, Hardcover-Abdeckung, 80 Blätter, Polyester 300D RPET Kugelschreiber Inklusiv.
 Set, Parapluie Pongée 190T, Tiges Fibre de Verre, 21", Système Anti-Vent, Étui Pongee RPET. Bidon Thermique Acter Inox Recyclé, 500 ml, Bloc Polyester 300D RPET, Couverture Rigide, 80 Feuilles, Stylo Polyester 300D RPET Inclusive.
 Set, Paraplu Pongee 190T, Glasvezel Ribben, 21", Windbestendig, Pongee RPET Zakje. Thermoskan-Flas Recycled Roestvrij Staal, 500 ml. Notepad Polyester 300D RPET, Harde Kaft, 80 Blaadjes. Pen Polyester 300D RPET Inclusief.

📏 35.5 x 7.5 x 31 cm 📖 5 🗑️ Print Code: F(1), C(1), G(1), L2, N(8)



1004

RAIN & COLD



New



Wolver 20344

Umbrella. Pongee 190T RPET. Fibreglass Ribs. 23", Automatic. Windproof.
Regenschirm. Pongee 190T RPET. Fiberglass Rippen. 23". Automatisch. Antiwindsystem.
Parapluie. Pongée 190T RPET. Tiges Fibre de Verre. 23". Automatique. Système Anti-Vent.
Paraplu. Pongee 190T RPET. Glasvezel Ribben. 23". Automatisch. Windbestendig.



Ø 105 cm 25 Print Code: G(1), N(8), R

11 06 01 02 16 03 19 07



RPET 

1005

RAIN & COLD

Gotley 20342

Umbrella. Pongee 190T RPET. Fiberglass Ribs. 23". Windproof. Bamboo Pole and Handle.
 Regenschirm. Pongee 190T RPET. Fiberglass Rippen. 23". Antiwindsystem. Bambus Stange und Griff.
 Parapluie. Pongée 190T RPET. Tiges Fibre de Verre. 23". Système Anti-Vent. Poignée et Tige en Bamboo.
 Paraplu. Pongee 190T RPET. Glasvezel Ribben. 23". Windbestendig. Bamboe Stok en Handvat.

 Ø 105 cm  20  Print Code: G(1), L2, N(8)





New

New

Dewey 20340 Ø 130 cm

Umbrella. Polyester 150D. Fiberglass Ribs. 30". Automatic. Windproof.
 Regenschirm. Polyester 150D. Fiberglass Rippen. 30". Automatisch. Antiwindsystem.
 Parapluie. Polyester 150D. Tiges Fibre de Verre. 30". Automatique. Système Anti-Vent.
 Paraplu. Polyester 150D. Glasvezel Ribben. 30". Automatisch. Windbestendig.

 Ø 130 cm  20  Print Code: G(1), N(8)

Estaro 20341 Ø 130 cm

Umbrella. Polyester 150D. Fiberglass Ribs. 30". Automatic. Windproof. EVA Handle.
 Regenschirm. Polyester 150D. Fiberglass Rippen. 30". Automatisch. Antiwindsystem. EVA Griff.
 Parapluie. Polyester 150D. Tiges Fibre de Verre. 30". Automatique. Système Anti-Vent. Poignée EVA.
 Paraplu. Polyester 150D. Glasvezel Ribben. 30". Automatisch. Windbestendig. EVA Handvat.

 Ø 130 cm  20  Print Code: G(1), N(8)





Bonaf 6316

Umbrella, Pongee 190T RPET, Metal Ribs, 23". Automatic, Wood Pole and Handle.

Regenschirm, Pongee 190T RPET, Metall Rippen, 23". Automatisch, Holz Stange und Griff.

Parapluie, Pongée 190T RPET, Tiges Métal, 23". Automatique, Poignée et Tige en Bois.

Paraplu, Pongee 190T RPET, Ribben Metaal, 23". Automatisch, Houten stok en Handvat.

☒ Ø 105 cm ☒ 25 ☒ Print Code: G(1), L2, N(8), R



Branit 1219

Umbrella, Pongee 190T RPET, Fibreglass Ribs, 22". Automatic, Windproof, Wood Handle, Pongee RPET Pouch.

Regenschirm, Pongee 190T RPET, Fiberglass Rippen, 22". Automatisch, Antiwindsystem, Holz Griff, Pongee RPET Etui.

Parapluie, Pongée 190T RPET, Tiges Fibre de Verre, 22". Automatique, Système Anti-Vent, Poignée en Bois, Étui Pongee RPET.

Paraplu, Pongee 190T RPET, Glasvezel Ribben, 22". Automatisch, Windbestendig, Houten Handvat, Pongee RPET Zakje.

☒ Ø 100 cm ☒ 30 ☒ Print Code: G(1), L2, N(8)



RPET

♻️ = ♻️ = ZERO WASTE

RPET



Brosian 6315

Umbrella, Pongee 190T RPET, Fibreglass Ribs, 21".
 Windproof, Wood Handle, Pongee Pouch.
 Regenschirm, Pongee 190T RPET, Fiberglass Rippen, 21".
 Antiwindsystem, Holz Griff, Pongee Etui.
 Parapluie, Pongée 190T RPET, Tiges Fibre de Verre, 21".
 Système Anti-Vent, Poignée en Bois, Étui Pongée.
 Paraplu, Pongee 190T RPET, Glasvezel Ribben, 21".
 Windbestendig, Houten Handvat, Pongee Zakje.

☒ ☒ ☒ Ø 97 cm ☒ 30 ☒ ☒
 Print Code: G(1), L2, N(8), R



REFLECTIVE

AUTOMATIC OPENING AND CLOSING



Nereus 1220

Umbrella, Pongee 190T RPET, Fibreglass Ribs, 22".
 Automatic, Windproof, Reflective, Pongee RPET Pouch.
 Regenschirm, Pongee 190T RPET, Fiberglass Rippen, 22".
 Automatisch, Antiwindsystem, Reflektierender, Pongee RPET Etui.
 Parapluie, Pongée 190T RPET, Tiges Fibre de Verre, 22".
 Automatique, Système Anti-Vent, Réfléchissant, Étui Pongee RPET.
 Paraplu, Pongee 190T RPET, Glasvezel Ribben, 22".
 Automatisch, Windbestendig, Reflectorend, Pongee RPET Zakje.

☒ ☒ ☒ Ø 100 cm ☒ 30 ☒ ☒ Print Code: G(1), N(8), V



06 02

Keitty 1088

Umbrella, Pongee 190T RPET, Fibreglass Ribs, 23". Automatic Opening and Closing, Windproof, Bamboo Handle, Pongee RPET Pouch.
 Regenschirm, Pongee 190T RPET, Fiberglass Rippen, 23". Automatisch Öffnen und Schließen, Antiwindsystem, Bambus Griff, Pongee RPET Etui.
 Parapluie, Pongée 190T RPET, Tiges Fibre de Verre, 23". Ouverture et Fermeture Automatiques, Système Anti-Vent, Poignée en Bambou, Étui Pongee RPET.
 Paraplu, Pongee 190T RPET, Glasvezel Ribben, 23". Automatisch Openen en Sluiten, Windbestendig, Bamboe Handvat, Pongee RPET Zakje.

☒ ☒ ☒ Ø 103 cm ☒ 30 ☒ ☒ Print Code: G(1), L2, N(8)

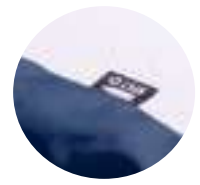



AUTOMATIC OPENING AND CLOSING



AUTOMATIC OPENING AND CLOSING

RPET 

Alexon 6787

Umbrella. Polyester 190T. Fibreglass Ribs. 21". Automatic Opening and Closing. Windproof. Polyester Pouch.
Regenschirm. Polyester 190T. Fiberglass Rippen. 21".
Automatisch Öffnen und Schließen. Antiwindsystem.
Polyester Etui.

Parapluie. Polyester 190T. Tiges Fibre de Verre. 21".
Ouverture et Fermeture Automatiques. Système Anti-Vent.
Étui Polyester.

Paraplu. Polyester 190T. Glasvezel Ribben. 21".
Automatisch Openen en Sluiten. Windbestendig. Polyester
Zakje.

 Ø 98 cm  30 / 10  Print Code: G(1), N(8)



Krastony 20343

Umbrella. Pongee 190T RPET. Fibreglass Ribs. 27". Automatic
Opening and Closing. Windproof. Pongee RPET Pouch.
Regenschirm. Pongee 190T RPET. Fiberglass Rippen. 27".
Automatisch Öffnen und Schließen. Antiwindsystem. Pongee
RPET Etui.

Parapluie. Pongée 190T RPET. Tiges Fibre de Verre. 27".
Ouverture et Fermeture Automatiques. Système Anti-Vent.
Étui Pongee RPET.

Paraplu. Pongee 190T RPET. Glasvezel Ribben. 27".
Automatisch Openen en Sluiten. Windbestendig. Pongee
RPET Zakje.

 Ø 120 cm  25  Print Code: G(1), N(8), R



 SUBLIMATION

BIG SIZE



Dolku 1803



Umbrella, Pongee 190T, Fibreglass Ribs, 30", Automatic, Windproof.
 Regenschirm, Pongee 190T, Fiberglass Rippen, 30", Automatisch, Antiwindsystem.
 Parapluie, Pongee 190T, Tiges Fibre de Verre, 30", Automatique, Système Anti-Vent.
 Paraplu, Pongee 190T, Glasvezel Ribben, 30", Automatisch, Windbestendig.

☒ Ø 130 cm ☒ 25 ☒ Print Code: G(1), N(8), R

Ø 130 cm

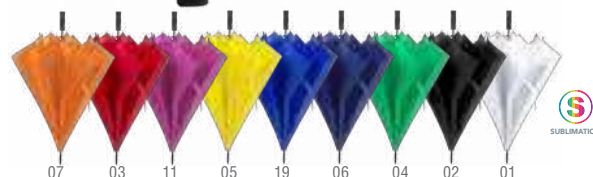

Panan 6105

Umbrella, Polyester 190T, Fibreglass Ribs, 30", Automatic, Windproof, EVA Handle.
 Regenschirm, Polyester 190T, Fiberglass Rippen, 30", Automatisch, Antiwindsystem, EVA Griff.
 Parapluie, Polyester 190T, Tiges Fibre de Verre, 30", Automatique, Système Anti-Vent, Poignée Eva.
 Paraplu, Polyester 190T, Glasvezel Ribben, 30", Automatisch, Windbestendig, EVA Handvat.

☒ Ø 130 cm ☒ 30 / 10 ☒ Print Code: G(1), N(8), R

Ø 130 cm

1010

RAIN & COLD

WOOD Handle



BIG SIZE

Ø 130 cm

Nouka 1801



Umbrella. Pongee 190T. Metal Ribs. 23". Wood Handle. Pongee Pouch.
Regenschirm. Pongee 190T. Metall Rippen. 23". Holz Griff. Pongee Etui.
Parapluie. Pongee 190T. Tiges Métal. 23". Poignée en Bois. Étui Pongee.
Paraplu. Pongee 190T. Metaal Ribben. 23". Houten Handvat. Pongee Zakje.

☒ Ø 106 cm ☒ 30 ☒ Print Code: G(1), L2, N(8), R

Tinnar 1810



Umbrella. Pongee 190T. Fiberglass Ribs. 30". Automatic. Windproof. Wood Handle.
Regenschirm. Pongee 190T. Fiberglass Rippen. 30". Automatisch. Antiwindsystem. Holz Griff.
Parapluie. Pongee 190T. Tiges Fibre de Verre. 30". Automatique. Système Anti-Vent. Poignée en Bois.
Paraplu. Pongee 190T. Glasvezel Ribben. 30". Automatisch. Windbestendig. Houten Handvat.

☒ Ø 130 cm ☒ 25 ☒ Print Code: G(1), L2, N(8), R

Tanesa 1802



Umbrella. Pongee 190T. Varilles Fibre de Verre. 27". Automatic. Windproof. Wood Handle.
Regenschirm. Pongee 190T. Fiberglass Rippen. 27". Automatisch. Antiwindsystem. Holz Griff.
Parapluie. Pongee 190T. Tiges Métal. 27". Automatique. Système Anti-Vent. Poignée en Bois.
Paraplu. Pongee 190T. Glasvezel Ribben. 27". Automatisch. Windbestendig. Houten Handvat.

☒ Ø 120 cm ☒ 25 ☒ Print Code: G(1), L2, N(8), R



20



07

Lagont 1947



Umbrella. Polyester 190T. Metal Ribs. 23". Automatic. Wood Pole and Handle.
 Regenschirm. Polyester 190T. Metall Rippen. 23". Automatisch. Holz Stange und Griff.
 Parapluie. Polyester 190T. Tiges Métal. 23". Automatique. Poignée et Tige en Bois.
 Paraplu. Polyester 190T. Ribben Metaal. 23". Automatisch. Houten Stok en Handvat.

☒ Ø 105 cm ☒ 25 ☒ Print Code: G(1), L2, N(8), R



01 06 02

Santy 9215



Umbrella. Polyester 190T. Metal Ribs. 23". Wood Pole and Handle.
 Regenschirm. Polyester 190T. Metall Rippen. 23". Holz Stange und Griff.
 Parapluie. Polyester 190T. Tiges Métal. 23". Poignée et Tige en Bois.
 Paraplu. Polyester 190T. Ribben Metaal. 23". Houten stok en Handvat.

☒ Ø 105 cm ☒ 25 ☒ Print Code: G(1), L2, N(8), R



03 13 02 05 01
 06 04 08 20 19



02

119

125

03

19

124

Korlet 6414

Umbrella. Polyester 190T. Metal Ribs. 23". Automatic. Wood Handle.
 Regenschirm. Polyester 190T. Metall Rippen. 23". Automatisch. Holz Griff.
 Parapluie. Polyester 190T. Tiges Métal. 23". Automatique. Poignée en Bois.
 Paraplu. Polyester 190T. Ribben Metaal. 23". Automatisch. Houten Handvat.

☒ Ø 105 cm ☒ 40 ☒ Print Code: G(1), L2, N(8), R



19

Meslop 4674

Umbrella. Polyester 190T. Metal Ribs. 23". Automatic.
 Regenschirm. Polyester 190T. Metall Rippen. 23". Automatisch.
 Parapluie. Polyester 190T. Tiges Métal. 23". Automatique.
 Paraplu. Polyester 190T. Ribben Metaal. 23". Automatisch.

☒ Ø 105 cm ☒ 25 ☒ Print Code: G(1), N(8), R



01 02 04 05 07 03 11



Hamfrey 5552

Reversible Umbrella. Pongee 190T. Fibreglass Ribs. 24".
Wenderegenschirm. Pongee 190T. Fiberglass Rippen. 24".
Parapluie Réversible. Pongée 190T. Tiges Fibre de Verre. 24".
Omkeerbare Paraplu. Pongee 190T. Glasvezel Ribben. 24".

☒ Ø 108 cm ☒ 30 / 10 ☒ Print Code: F(1), G(1), N(8), L2



SPECIAL Hands-Free



03



Halrum 5706

Umbrella. Polyester 190T. Fibreglass Ribs. 23". Automatic. Windproof.
Regenschirm. Polyester 190T. Fiberglass Rippen. 23". Automatisch. Antiwindsystem.
Parapluie. Polyester 190T. Tiges Fibre de Verre. 23". Automatique. Système Anti-Vent.
Paraplu. Polyester 190T. Glasvezel Ribben. 23". Automatisch. Windbestendig.

☒ Ø 105 cm ☒ 30 / 10 ☒ Print Code: F(1), G(1), N(8), L2, R



Brosmon 5707

Umbrella. Pongee 190T. Fibreglass Ribs. 21". Windproof.
Pongee Pouch.
Regenschirm. Pongee 190T. Fiberglass Rippen. 21".
Antiwindsystem. Pongee Etui.
Parapluie. Pongée 190T. Tiges Fibre de Verre. 21". Système
Anti-Vent. Étui Pongée.
Paraplu. Pongee 190T. Glasvezel Ribben. 21". Windbestendig.
Pongee Zakje.

☒ Ø 98 cm ☒ 30 / 10 ☒ Print Code: G(1), N(8), R

AUTOMATIC UMBRELLA

1013

W & COLD



02 20 06



04 02 06 03

Elmer 3553

Umbrella, Pongee 190T, Metal Ribs, 21", Automatic, EVA Ergonomic Handle, Pongee Pouch.
Regenschirm, Pongee 190T, Metall Rippen, 21", Automatisch, EVA Ergonomischer Griff, Pongee Etui.
Parapluie, Pongée 190T, Tiges Métal, 21", Automatique, Poignée Ergonomique EVA, Étui Pongée.
Paraplu, Pongee 190T, Ribben Metaal, 21", Automatisch, EVA Ergonomisch Handvat, Pongee Zakje.

☐ 98 cm ☐ 30 / 10 ☐ Print Code: G(1), N(8)

Hebol 4601

Umbrella, Pongee 190T, Metal Ribs, 22", Automatic, Pongee Pouch.
Regenschirm, Pongee 190T, Metall Rippen, 22", Automatisch, Pongee Etui.
Parapluie, Pongée 190T, Tiges Métal, 22", Automatique, Étui Pongée.
Paraplu, Pongee 190T, Ribben Metaal, 22", Automatisch, Pongee Zakje.

☐ 100 cm ☐ 30 / 10 ☐ Print Code: G(1), N(8), V



Royal 7157

Umbrella. Pongee 190T. Metal Ribs. 22". Automatic. PU Handle. Pongee Pouch.
 Regenschirm. Pongee 190T. Metall Rippen. 22". Automatisch. PU Griff. Pongee Etui.
 Parapluie. Pongée 190T. Tiges Métal. 22". Automatique. Poignée Similicuir. Étui Pongée.
 Paraplu. Pongee 190T. Ribben Metaal. 22". Automatisch. PU Handvat. Pongee Zakje.

☒ Ø 100 cm ☒ 25 ☒ Print Code: G(1), N(8)

Campbell 7153

Umbrella. Pongee 190T. Fibreglass Ribs. 27". Automatic. Windproof. Pongee Pouch Included.
 Regenschirm. Pongee 190T. Fiberglass Rippen. 27". Automatisch. Antiwindsystem. Pongee Etui.
 Parapluie. Pongée 190T. Tiges Fibre de Verre. 27". Automatique. Système Anti-Vent. Étui Pongée.
 Paraplu. Pongee 190T. Glasvezel Ribben. 27". Automatisch. Windbestendig. Pongee Zakje.

☒ Ø 120 cm ☒ 25 ☒ Print Code: G(1), N(8)

ANTONIO MIRO



Antonio Miró is currently a benchmark in the increasingly demanding fashion industry. Worldwide renowned and consolidated in showcases such as Paris, Milan, New York and Tokyo, with prestige earned by collections based on simplicity and perfection, being these his personal hallmarks. Minimalist like few others, Antonio Miró devotes his success to elegance, an objective he has never renounced.



1015

RAIN & COLD



Telfox 7154

Umbrella. Pongee 190T, Fibreglass Ribs, 21". Automatic Opening and Closing, Windproof, Polyester Pouch.
Regenschirm. Pongee 190T, Fiberglass Rippen, 21". Automatisch Öffnen und Schließen, Antiwindsystem, Polyester Etui.
Parapluie. Pongée 190T, Tiges Fibre de Verre, 21". Ouverture et Fermeture Automatiques, Système Anti-Vent, Étui Polyester.
Paraplu. Pongee 190T, Glasvezel Ribben, 21". Automatisch Openen en Sluiten, Windbestendig, Polyester Zakje.

☒ 95 cm ☑ 30 / 10 ☎ Print Code: G(1), N(8)



Kira 7248

Blanket. Polar Fleece 260 g/ m2, Anti-Pilling.
Decke. Polar Fleece 260 g/ m2, Anti-Pilling.
Couverture. Polaire 260 g/ m2, Anti-Pilling.
Deken. Polar Fleece 260 g/ m2, Anti-Pilling.

☒ 160 x 130 cm ☑ 20 ☎ Print Code: P



Montello 9486

Raincoat. PVC. One Size. Adult. 127 x 100 cm. PVC Pouch.
 Poncho. PVC. Einheitsgröße. Erwachsene. 127 x 100 cm. PVC Etui.
 Poncho. PVC. Taille Unique. Adulte. 127 x 100 cm. Étui PVC.
 Regenjas. PVC. Eén Maat. Volwassen. 127 x 100 cm. PVC Zakje.

📏 22.5 x 18 cm 📦 50 🗑️ Print Code: G(1), H(1)



03



Hydrus 3880

Raincoat. EVA. One Size. Adult. Polyester Pouch.
 Regenjacke. EVA. Einheitsgröße. Erwachsene. Polyester Etui.
 Imperméable. EVA. Taille Unique. Adulte. Étui Polyester.
 Regenjas. EVA. Eén Maat. Volwassen. Polyester Zakje.

📏 Ø 10 x 27 cm 📦 50 / 10 🗑️ Print Code: G(1), H(1)



19



05

Zaril 4262

Raincoat. PEVA. One Size. Adult. 127 x 102 cm. Polyester Pouch.
 Poncho. PEVA. Einheitsgröße. Erwachsene. 127 x 102 cm. Polyester Etui.
 Poncho. PEVA. Taille Unique. Adulte. 127 x 102 cm. Étui Polyester.
 Regenjas. PEVA. Eén Maat. Volwassen. 127 x 102 cm. Polyester Zakje.

📏 Ø 6 x 19 cm 📦 100 / 50 🗑️ Print Code: Consulair



Hips 9862

Raincoat. PVC. Waistbag Convertible.
 Regenjacke. PVC. Verwandelbaar in Gürteltasche.
 Imperméable. PVC. Convertible en Pochette.
 Regenjas. PVC. Veranderbaar in Heuptas.

📏 M-L, XL-XXL 📦 50 🗑️ Print Code: G(1), H(1)



06



WAISTBAG
 CONVERTIBLE



Reizon 6589

Raincoat. PLA 100% Compostable. One Size. Adult. 127 x 102 cm.
 Poncho. PLA 100% Kompostierbar. Einheitsgröße. Erwachsene. 127 x 102 cm.
 Poncho. PLA 100% Compostable. Taille Unique. Adulte. 127 x 102 cm.
 Regenjas. PLA 100% Composteerbaar. Eén Maat. Volwassen. 127 x 102 cm.

10 x 13.5 cm 200 / 20 Print Code: E(1)

RPET



Brinek 1478

Raincoat. LDPE. One Size. Adult. 127 x 102 cm. Polyester RPET Pouch.
 Poncho. LDPE. Einheitsgröße. Erwachsene. 127 x 102 cm. Polyester RPET Etui.
 Poncho. LDPE. Taille Unique. Adulte. 127 x 102 cm. Étui Polyester RPET.
 Regenjas. LDPE. Eén Maat. Volwassen. 127 x 102 cm. Polyester RPET Zakje.

8 x 8 x 2.5 cm 200 / 25 Print Code: E(1)



Gol 1084

Keyring Raincoat. LDPE. One Size. Adult. 120 x 90 cm.
 Schlüsselanhänger Poncho. LDPE. Einheitsgröße. Erwachsene. 120 x 90 cm.
 Porte-Clés Poncho. LDPE. Taille Unique. Adulte. 120 x 90 cm.
 Sleutelhanger Regenjas. LDPE. Eén Maat. Volwassen. 120 x 90 cm.

Ø 6.3 cm 200 / 25 Print Code: D(1)



Birtox 6357

Keyring Raincoat. LDPE. One Size. Adult. 127 x 102 cm.
 Schlüsselanhänger Poncho. LDPE. Einheitsgröße. Erwachsene. 127 x 102 cm.
 Porte-Clés Poncho. LDPE. Taille Unique. Adulte. 127 x 102 cm.
 Sleutelhanger Regenjas. LDPE. Eén Maat. Volwassen. 127 x 102 cm.

Ø 5.5 x 5.1 cm 200 / 50 Print Code: D(4), W



Remo 3503

Raincoat. HDPE. One Size. Adult. 127 x 102 cm.
 Poncho. HDPE. Einheitsgröße. Erwachsene. 127 x 102 cm.
 Poncho. HDPE. Taille Unique. Adulte. 127 x 102 cm.
 Regenjas. HDPE. Eén Maat. Volwassen. 127 x 102 cm.

10 x 13.5 cm 200 / 20 Print Code: E(1)

New



06

150 x 120 cm

Cindra 20336

Blanket. Polyester 240 g/ m².
 Decke. Polyester 240 g/ m².
 Couverture. Polyester 240 g/ m².
 Deken. Polyester 240 g/ m².

150 x 120 cm 20
 Print Code: E(1), N(8), O, P

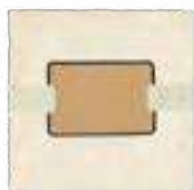

18



13

LIMITED
edition
EXPERIENCE

Haltebes 1617

Blanket. Coral Fleece/ Sherpa 380 g/ m². Anti-Pilling.
 Decke. Coral Fleece/ Sherpa 380 g/ m². Anti-Pilling.
 Couverture. Polaire Coral/ Sherpa 380 g/ m². Anti-Pilling.
 Deken. Coral Fleece/ Sherpa 380 g/ m². Anti-Pilling.

160 x 125 cm 10
 Print Code: F(1)

160 x 125 cm

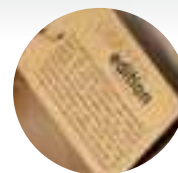

02

160 x 125 cm

08



160 x 125 cm

Lerten 6045

Blanket. Coral Fleece/ Sherpa 380 g/ m².
 Decke. Coral Fleece/ Sherpa 380 g/ m².
 Couverture. Polaire Coral/ Sherpa 380 g/ m².
 Deken. Coral Fleece/ Sherpa 380 g/ m².

160 x 125 cm 10
 Print Code: E(1), N(8), O, P



06

03

18

Karovix 6936

Blanket. Coral Fleece/ Sherpa 440 g/ m².
 Decke. Coral Fleece/ Sherpa 440 g/ m².
 Couverture. Polaire Coral/ Sherpa 440 g/ m².
 Deken. Coral Fleece/ Sherpa 440 g/ m².

160 x 125 cm 10
 Print Code: E(1), P



06

08



Durmok 20159

Blanket. Coral Fleece 260 g/ m2. Anti-Pilling.
 Decke. Coral Fleece 260 g/ m2. Anti-Pilling.
 Couverture. Polaire Corail 260 g/ m2. Anti-Pilling.
 Deken. Coral Fleece 260 g/ m2. Anti-Pilling.

160 x 130 cm 20 Print Code: E(1)

160 x 130 cm



Menex 4358

Blanket. Polar Fleece 180 g/ m2. Anti-Pilling.
 Decke. Polar Fleece 180 g/ m2. Anti-Pilling.
 Couverture. Polaire 180 g/ m2. Anti-Pilling.
 Deken. Polar Fleece 180 g/ m2. Anti-Pilling.

150 x 120 cm 20 Print Code: N(8), O, P

150 x 120 cm



150 x 120 cm

Thiago 5213

Blanket. Polar Fleece 180 g/ m2. Polyester Pouch.
 Decke. Polar Fleece 180 g/ m2. Polyester Etui.
 Couverture. Polaire 180 g/ m2. Étui Polyester.
 Deken. Polar Fleece 180 g/ m2. Polyester Zakje.

150 x 120 cm 20 Print Code: E(1), N(8), O, P



160 x 130 cm

Mountain 9248

Blanket. Polar Fleece 200 g/ m2. Anti-Pilling.
 Decke. Polar Fleece 200 g/ m2. Anti-Pilling.
 Couverture. Polaire 200 g/ m2. Anti-Pilling.
 Deken. Polar Fleece 200 g/ m2. Anti-Pilling.

160 x 130 cm 25 Print Code: E(1), N(8), O, P





RPET



150 x 120 cm

06

13

08

02

Kayla 6748

Blanket. Polyester RPET 200 g/ m². Polyester RPET Pouch.
 Decke. Polyester RPET 200 g/ m². Polyester RPET Etui inklusive.
 Couverture. Polyester RPET 200 g/ m². Étui Polyester RPET.
 Deken. Polyester RPET 200 g/ m². Polyester RPET Zakje.

150 x 120 cm 20 Print Code: E(1), N(8), O, P



New



03

19

08

Barzagli 20334

Blanket. Polyester RPET 200 g/ m². Polyester RPET Pouch.
 Decke. Polyester RPET 200 g/ m². Polyester RPET Etui inklusive.
 Couverture. Polyester RPET 200 g/ m². Étui Polyester RPET.
 Deken. Polyester RPET 200 g/ m². Polyester RPET Zakje.

150 x 120 cm

150 x 120 cm 20 Print Code: E(1), N(8), O, P



160 x 130 cm

Bibbly 1221

Blanket. Polyester RPET 200 g/ m². Cotton Pouch.
 Decke. Polyester RPET 200 g/ m². Baumwolle Etui.
 Couverture. Polyester RPET 200 g/ m². Étui Coton.
 Deken. Polyester RPET 200 g/ m². Katoen Zakje.

160 x 130 cm 20 Print Code: E(1), N(8), O, P



SOCKS & SLIPPERS WINTER

1021

RAIN & COLD



New



Molbik 5507

Sock. Polyester. One Size 36-43. Anti-Slip.
 Socken. Polyester. Einheitsgröße 36-43. Rutschfest.
 Chaussette. Polyester. Taille Unique 36-43. Antidérapant.
 Sok. Polyester. Eén Maat 36-43. Anti-Slip.

Consult. 100 / 10 Print Code: N(8)



Coulter 20112

Slippers. Cotton/ Polyester. Anti-Slip.
 Pantoffeln. Baumwolle/ Polyester. Rutschfest.
 Pantoufles. Coton/ Polyester. Antidérapante.
 Slippers. Katoen/ Polyester. Anti-Slip.

Consult. 36-38, 42-44. 50

RPET



RAIN & COLD

06
03
02
08



New



Duvan 20337

Neck Warmer. Polyester RPET.
Nacken Wärmer. Polyester RPET.
Tour de Cou. Polyester RPET.
Colsjaal. Polyester RPET.

25 x 38 cm 300 / 100
Print Code: G(1), N(8), O, P

19



01



08



06



02

Suanix 6856

Neck Warmer. Polyester RPET.
Nacken Wärmer. Polyester RPET.
Tour de Cou. Polyester RPET.
Colsjaal. Polyester RPET.

25 x 50 cm 300 / 100 Print Code: G(1), N(8), O, P

ORGANIC COTTON



227

Omega 6935

Neck Warmer. 100% Organic Cotton.
Nacken Wärmer. 100% Organische Baumwolle.
Tour de Cou. 100% Coton Organique.
Colsjaal. 100% Organisch Katoen.

25 x 60 cm 300 / 100
Print Code: G(1), N(8), O, P



08



06



02



Nical 2599

Antibacterial Neck Warmer. Polyester.
Antibakteriell Nacken Wärmer. Polyester.
Tour de Cou Antibacterienne. Polyester.
Antibacterieel Colsjaal. Polyester.

26 x 48 cm 300 / 10 Print Code: G(1), N(8), O, P, R



ANTIBACTERIAL & WATER RESISTANT



Cherin 4215

Neck Warmer. Polyester.
 Nacken Wärmer. Polyester.
 Tour de Cou. Polyester.
 Colsjaal. Polyester.

25 x 50 cm 300 / 100
 Print Code: G(1), N(8), R



New

13

Rehony 21167

Neck Warmer. Outside: 100% Polyester. Inside: 100% Polyester Microfleece.
 Nacken Wärmer. Äußere: 100% Polyester. Innen: 100% Polyester Microfleece.
 Tour de Cou. Extérieur: 100% Polyester. Intérieur: 100% Polyester Microfleece.
 Colsjaal. Buitenzijde: 100% Polyester. Binnenzijde: 100% Polyester Microfleece.

25 x 25 cm 200 / 20 Print Code: N(8)



08



02



06



Ponkar 5913

Neck Warmer and Hat. Outside: Polyester/ Spandex. Inside: Coral Fleece. 280 g/ m2.
 Nacken Wärmer und Hut. Äußere: Polyester/ Spandex. Innen: Coral Fleece. 280 g/ m2.
 Tour de Cou et Bonnet. Extérieur: Polyester/ Spandex. Intérieur: Polaire Coral. 280 g/ m2.
 Colsjaal en Muts. Buitenzijde: Polyester/ Spandex. Binnenzijde: Coral Fleece. 280 g/ m2.

25 x 28 cm 100 / 10 Print Code: G(1), N(8), O, P, R



SPECIAL WHITE
 COLOUR
 FOR SUBLIMATION

CORAL FLEECE INSIDE
 IDEAL FABRIC
 FOR PRINTING



Articos 8016

Neck Warmer and Hat. Polar Fleece 200 g/ m2. Anti-Pilling.
 Nacken Wärmer und Hut. Polar Fleece 200 g/ m2. Anti-Pilling.
 Tour de Cou et Bonnet. Polaire 200 g/ m2. Anti-Pilling.
 Colsjaal en Muts. Polar Fleece 200 g/ m2. Anti-Pilling.

24.5 x 25.5 cm 100 / 10 Print Code: G(1), N(8), O, P



New



Tecko 20345

Neck Warmer and Hat. Polar Fleece 200 g/ m2. Anti-Pilling.
Nacken Wärmer und Hut. Polar Fleece 200 g/ m2. Anti-Pilling.
Tour de Cou et Bonnet. Polaire 200 g/ m2. Anti-Pilling.
Colsjaal en Muts. Polar Fleece 200 g/ m2. Anti-Pilling.

30 x 37 cm 100 / 10
Print Code: G(1), N(8), O, P

13



01

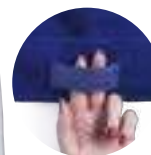

Holsen 5817

Hat. Acrylic.
Hut. Acryl.
Bonnet. Acrylique.
Muts. Acryl.

Consult. 200 / 10
Print Code: E(1), N(8)



06

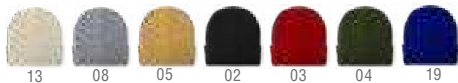

Lana 8017

Hat. Acrylic.
Hut. Acryl.
Bonnet. Acrylique.
Muts. Acryl.

Consult. 250 / 25
Print Code: N(8), O, P



08



Baikof 5592

Hat. Acrylic.
Hut. Acryl.
Bonnet. Acrylique.
Muts. Acryl.

Consult. 100 / 10
Print Code: N(8), O, P



OUTSIDE
POLYESTER /
SPANDEX

CORAL FLEECE INSIDE 08



Folten 5914

Hat. Outside: Polyester/ Spandex. Inside: Coral Fleece. 280 g/ m2.
Hut. Äußere: Polyester/ Spandex. Innen: Coral Fleece. 280 g/ m2.
Bonnet. Extérieur: Polyester/ Spandex. Intérieur: Polaire Corail. 280 g/ m2.
Muts. Buitenzijde: Polyester/ Spandex. Binnenzijde: Coral Fleece. 280 g/ m2.

Consult. 100 / 10
Print Code: F(1), N(8), O, P, R





13

New

Simiut 21166

Hat. Outside: 100% Polyester. Inside: 100% Polyester Microfleece.
 Hut. Äußere: 100% Polyester. Innen: 100% Polyester Microfleece.
 Bonnet. Extérieur: 100% Polyester. Intérieur: 100% Polyester Microfleece.
 Muts. Buitenzijde: 100% Polyester. Binnenzijde: 100% Polyester Microfleece.

Consult. 100 / 10
 Print Code: N(8)



08



06



02



SPECIAL
PRINTING
AREA



06

Selsoker 1442

Hat. Acrylic.
 Hut. Acryl.
 Bonnet. Acrylique.
 Muts. Acryl.

Consult. 200 / 10 Print Code: E(t), N(8)



13



371



02



08



ORGANIC
COTTON



08



06



02



227

Daison 6934

Hat. 100% Organic Cotton.
 Hut. 100% Organische Baumwolle.
 Bonnet. 100% Coton Organique.
 Muts. 100% Organisch Katoen.

Consult. 150 / 25 Print Code: N(8), O, P



08



13



08



06



02

Hetul 6854

Hat. Polyester RPET.
 Hut. Polyester RPET.
 Bonnet. Polyester RPET.
 Muts. Polyester RPET.

Consult. 250 / 25 Print Code: N(8), O, P



RPET



Terban 6440

Hat, Outside: Acrylic. Inside: Polar Fleece. Reflective.
 Hut, Äußere: Acryl. Innen: Polar Fleece. Reflektierend.
 Bonnet, Extérieur: Acrylique. Intérieur: Polaire. Réfléchissant.
 Muts, Buitenzijde: Acryl. Binnenzijde: Polar Fleece. Reflectorend.

Consult. 100 / 10 Print Code: N(8), P

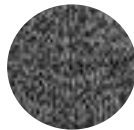

ULTRA
REFLECTIVE

New



UL'RA
REFLECTIVE

Dolberg 20338

Neck Warmer, Acrylic. Reflective.
 Nackenwärmer, Acryl. Reflektierend.
 Tour de Cou, Acrylique. Réfléchissant.
 Colsjaal, Acryl. Reflectorend.

25 x 50 cm 50 / 10 Print Code: G(1), N(8), O, P



08

Koppy 6558

Hat, Acrylic. 4 Leds. 4 Light Modes, Fixed and Flashing. Battery 300 mAh.
 Hut, Acryl. 4 Leds. 4 Lichtpositionen, Festes und Blinkendes. Batterie 300 mAh.
 Bonnet, Acrylique. 4 Leds. 4 Modes de Lumière, Fixe et Clignotante. Batterie 300 mAh.
 Muts, Acryl. 4 Leds. 4 Licht Posities, Vast en Knipperend. Batterij 300 mAh.

Consult. 100 / 50 Print Code: N(8)



02



02

Prasan 1805

Set, Acrylic. Hat and Touchscreen Gloves, One Size, Adult.
 Set, Acryl. Hut and Touchpad Handschuhe, Einheitsgröße, Erwachsene.
 Set, Acrylique. Bonnet et Gants Tactile, Taille Unique, Adulte.
 Set, Acryl. Muts en Touchscreen Handschoenen, Eén Maat, Volwassen.

Consult. 150 / 10 Print Code: E(1), L1



06

THREE TOUCH SCREEN FINGERTIPS

RPET



08



02

13

06

REVERSIBLE

Skix 1807

Reversible Hat. Outside: Polyester RPET. Inside: Polar Fleece. Anti-Pilling.
 Wendehut. Äußere: Polyester RPET. Innen: Polar Fleece. Anti-Pilling.
 Bonnet Réversible. Extérieur: Polyester RPET. Intérieur: Polaire. Anti-Pilling.
 Omkeerbare Muts. Buitenzijde: Polyester RPET. Binnenzijde: Polar Fleece. Anti-Pilling.

Consult. 200 / 50 Print Code: F(1), N(8), O



06



20

13

227

02

03

19

REVERSIBLE

Nesy 9066

Reversible Hat. Outside: Nylon. Inside: Polar Fleece. Anti-Pilling.
 Wendehut. Äußere: Nylon. Innen: Polar Fleece. Anti-Pilling.
 Bonnet Réversible. Extérieur: Nylon. Intérieur: Polaire. Anti-Pilling.
 Omkeerbare Muts. Buitenzijde: Nylon. Binnenzijde: Polar Fleece. Anti-Pilling.

Consult. 200 / 50 Print Code: F(1), N(8), O



08

New



New



08

02

06

14

Prody 20155

Cap. Thick Polyester. Buckle Closure.
 Mütze. Groß Polyester. Schnallen Verschluss.
 Casquette. Polyester Épais. Fermeture à Boucle.
 Pet. Dikke Polyester. Gesp Stuiting.

Consult. 100 / 25 Print Code: N(8), O, P



02

Bruck 20157

Cap. 100% Cotton. Velcro Closure.
 Mütze. 100% Baumwolle. Klett Verschluss.
 Casquette. 100% Coton. Fermeture Velcro.
 Pet. 100% Katoen. Klittenband Stuiting.

Consult. 200 / 25 Print Code: F(1), N(8), O, P



13



New

Fruwel 20154

Gloves. Acrylic. One Size. Adult.
 Handschuhe. Acryl. Einheitsgröße. Erwachsene.
 Gant. Acrylique. Taille Unique. Adulte.
 Handschoenen. Acryl. Eén Maat. Volwassen.

Consult. 200 / 10
 Print Code: N(8)



02

13

ANTI TOUCH SCREEN FINGERTIPS

Tellar 5131

Touchscreen Gloves. Acrylic. One Size. Adult.
 Touchpad Handschuhe. Acryl. Einheitsgröße. Erwachsene.
 Gant Tactile. Acrylique. Taille Unique. Adulte.
 Touchscreen Handschoenen. Acryl. Eén Maat. Volwassen.

Consult. 200 / 10 Print Code: N(8)



02

TWO TOUCH
 SCREEN FIN-
 GERTIPS



03

19

Vanzox 5917

Touchscreen Sport Gloves. Polyester/ Lycra. One Size. Adult.
 Touchpad Sport Handschuhe. Polyester/ Lycra. Einheitsgröße. Erwachsene.
 Gant Sportif Tactile. Polyester/ Lycra. Taille Unique. Adulte.
 Touchscreen Sport Handschoenen. Polyester/ Lycra. Eén Maat. Volwassen. 08

Consult. 200 / 10 Print Code: E(1), N(8)

ANTI SLIP





New

RPET 

THREE TOUCH SCREEN FINGERTIPS



08

Despil 6855

Touchscreen Gloves. Polyester RPET. One Size. Adult.
Touchpad Handschuhe. Polyester RPET. Einheitsgröße. Erwachsene.
Gant Tactile. Polyester RPET. Taille Unique. Adulte.
Touchscreen Handschoenen. Polyester RPET. Eén Maat. Volwassen.

 Consult.  200 / 10  Print Code: N(8)



06

02

Demsey 20339

Touchscreen Gloves. Polyester RPET. One Size. Adult.
Touchpad Handschuhe. Polyester RPET. Einheitsgröße. Erwachsene.
Gant Tactile. Polyester RPET. Taille Unique. Adulte.
Touchscreen Handschoenen. Polyester RPET. Eén Maat. Volwassen.

 Consult.  200 / 50  Print Code: E(1), L1





THREE TOUCH SCREEN FINGERTIPS



02

Actium 4010

Touchscreen Gloves. Acrylic. One Size. Adult.
Touchpad Handschuhe. Acryl. Einheitsgröße. Erwachsene.
Gant Tactile. Acrylique. Taille Unique. Adulte.
Touchscreen Handschoenen. Acryl. Eén Maat. Volwassen.

 Consult.  200 / 10  Print Code: N(8)



19

03

05

08

04

11

Tenex 6703

Antibacterial Touchscreen Gloves. Acrylic. One Size. Adult.
Antibakterieel Touchpad Handschuhe. Acryl. Einheitsgröße. Erwachsene.
Gant Tactile Antibacterienne. Acrylique. Taille Unique. Adulte.
Antibacterieel Touchscreen Handschoenen. Acryl. Eén Maat. Volwassen.

 Consult.  200 / 10  Print Code: N(8)

THREE TOUCH SCREEN FINGERTIPS





08

02

Kinar 1806

Scarf. Acrylic.
Schal. Acryl.
Écharpe. Acrylique.
Sjaal. Acryl.

160 x 30 cm 80 / 40
Print Code: G(1), N(8), P



06

New

RPET



08

Aronax 20335

Scarf. Polyester RPET.
Schal. Polyester RPET.
Écharpe. Polyester RPET.
Sjaal. Polyester RPET.

160 x 21 cm 40
Print Code: N(8), P



02

06



08

Polar 8012

Scarf. Polar Fleece 200 g/ m2. Anti-Pilling.
Schal. Polar Fleece 200 g/ m2. Anti-Pilling.
Écharpe. Polaire 200 g/ m2. Anti-Pilling.
Sjaal. Polar Fleece 200 g/ m2. Anti-Pilling.

160 x 29 cm 100 / 20
Print Code: N(8), O, P



02

06

03

13

UNISEX



ORGANIC COTTON 



08





04

13

Betty 1011

Foulard. 100% Organic Cotton. Organic Cotton Pouch.
 Foulard. 100% Organische Baumwolle. Organische Baumwolle Etui.
 Foulard. 100% Coton Organique. Étui Coton Organique.
 Sjaaltje. 100% Organisch Katoen. Organisch Katoen Zakje.

 180 x 50 cm  100 / 10
 Print Code: F(1), N(8)



13

22

06

Ribban 5916

Foulard. Viscose.
 Foulard. Viskose.
 Foulard. Viscose.
 Sjaaltje. Viscose.

 180 x 70 cm  100 / 10
 Print Code: F(1), N(8)



11

02

03

04



KIDS



Holiam 5506

Neck Warmer. Polyester.
Nacken Wärmer. Polyester.
Tour de Cou. Polyester.
Colsjaal. Polyester.

21 x 40 cm 500 / 100
Print Code: G(1), N(8), R



Anut 3721

Scarf. Polar Fleece 180 g/ m2.
Schal. Polar Fleece 180 g/ m2.
Écharpe. Polaire 180 g/ m2.
Sjaal. Polar Fleece 180 g/ m2.

91 x 12 cm 400 / 10 Print Code: N(8), O, P



TWO TOUCH SCREEN FINGERTIPS

05

Pigun 5132

Touchscreen Gloves. Acrylic. One Size. Kids.
Touchpad Handschuhe. Acryl. Einheitsgröße. Kinder.
Gant Tactile. Acrylique. Taille Unique. Enfant.
Touchscreen Handschoenen. Acryl. Eén Maat. Kind.

Consult. 500 / 10 Print Code: N(8)



04

03

19

Siku 3720

Mitten. Polar Fleece 180 g/ m2. One Size. Kids.
Handschuh. Polar Fleece 180 g/ m2. Einheitsgröße. Kinder.
Gant. Polaire 180 g/ m2. Taille Unique. Enfant.
Wanten. Polar Fleece 180 g/ m2. Eén Maat. Kind.

8 x 11 cm 400 / 10 Print Code: N(8), O



19



05

03



Seter 20367

Umbrella. Polyester 190T. Metal Ribs. 18". Automatic. Polyester Pouch.
 Regenschirm. Polyester 190T. Metall Rippen. 18". Automatisch. Polyester Etui.
 Parapluie. Polyester 190T. Tiges Métal. 18". Automatique. Étui Polyester.
 Paraplu. Polyester 190T. Ribben Metaal. 18". Automatisch. Polyester Zakje.

☒ 78 cm ☑ 50 ☎ Print Code: G(1), N(8)

RAIN
KIDS



Teo 3221

Raincoat. PVC. One Size. Kids. 90 x 64 cm. PVC Pouch.
 Poncho. PVC. Einheitsgröße. Kinder. 90 x 64 cm. PVC Etui.
 Poncho. PVC. Taille Unique. Enfant. 90 x 64 cm. Étui PVC.
 Kinder-Regenjas. PVC. Eén Maat. Kind. 90 x 64 cm. PVC Zakje.

☒ 18 x 15 cm ☑ 100 / 25 ☎ Print Code: G(1), H(1)



Claytop 20346

Raincoat. PE. One Size. Kids. 90 x 64 cm. Polyester RPET Pouch.
 Poncho. PE. Einheitsgröße. Kinder. 90 x 64 cm. Polyester RPET Etui.
 Poncho. PE. Taille Unique. Enfant. 90 x 64 cm. Étui Polyester RPET.
 Kinder-Regenjas. PE. Eén Maat. Kind. 90 x 64 cm. Polyester RPET Zakje.

☒ 8.5 x 10 x 2 cm ☑ 200 / 25 ☎ Print Code: E(1)



RPET ♻️

import made easy



 **asiaexpress**
DIRECT IMPORTS SERVICE



**Bespoke Umbrella:
Create a color combination,
add your logo and choose
your materials.**



æ asiaexpress
DIRECT IMPORTS SERVICE

**Import
made
easy.**



28 **SUBLIMATION LINE**





**COLOUR,
CREATIVE,
NON LIMITS**

New

350 ml



New

350 ml



Cervan 20516

Sublimation Mug, Glass, 350 ml.
 Sublimations Tasse, Glas, 350 ml.
 Tasse Sublimation, Verre, 350 ml.
 Sublimatie Mok, Glas, 350 ml.



☞ Ø 8 × 9.6 cm ☞ 36 ☞ Print Code: L1, Q

Osaka 20512

Sublimation Mug, Glass, 350 ml.
 Sublimations Tasse, Glas, 350 ml.
 Tasse Sublimation, Verre, 350 ml.
 Sublimatie Mok, Glas, 350 ml.



☞ Ø 8 × 9.6 cm ☞ 36 ☞ Print Code: L1, Q

New

330 ml



Loter 20511

Sublimation Cup, Glass, 330 ml.
 Sublimations Trinkbecher, Glas, 330 ml.
 Verre Sublimation, Verre, 330 ml.
 Sublimatie Beker, Glas, 330 ml.

☞ Ø 8.1 × 10 cm ☞ 36 ☞ Print Code: L1, Q

350 ml



Amira 1759

Sublimation Mug, Glass, 350 ml.
 Sublimations Tasse, Glas, 350 ml.
 Tasse Sublimation, Verre, 350 ml.
 Sublimatie Mok, Glas, 350 ml.

☞ Ø 8 × 9.6 cm ☞ 36 ☞ Print Code: F(1), L1, Q

New

500 ml



Oxia 20510

Sublimation Jug, Glass, 500 ml.
 Sublimations Krug, Glas, 500 ml.
 Carafe Sublimation, Verre, 500 ml.
 Sublimatie Kan, Glas, 500 ml.

☞ Ø 8 × 15 cm ☞ 20 ☞ Print Code: L1, Q

special Glass SUBLIMATION

1039

SUBLIMATION LINE



Fonix 20514

Sublimation Jar, Glass/ Bamboo, 400 ml.
Sublimations Krug, Glas/ Bambus, 400 ml.
Pot Sublimation, Verre/ Bambou, 400 ml.
Sublimatie Pot, Glas/ Bamboe, 400 ml.

☐ 7.7 x 12.5 cm ☑ 30 ☎ Print Code: L1, Q



Kaory 1774

Sublimation Bottle, Glass/ Bamboo, 500 ml.
Sublimations Trinkflasche, Glas/ Bambus, 500 ml.
Bidon Sublimation, Verre/ Bambou, 500 ml.
Sublimatie Fles, Glas/ Bamboe, 500 ml.

☐ 6.3 x 22.5 cm ☑ 50 ☎ Print Code: F(1), L1, L2, Q, WR



Vantex 20515

Sublimation Bottle, Glass/ Bamboo, 500 ml.
Sublimations Trinkflasche, Glas/ Bambus, 500 ml.
Bidon Sublimation, Verre/ Bambou, 500 ml.
Sublimatie Fles, Glas/ Bamboe, 500 ml.

☐ 6.3 x 22.5 cm ☑ 50 ☎ Print Code: L1, L2, Q



21



22

05

07

16

New
350 ml



20

New
350 ml



19

Orchix 20509

Sublimation Mug, Ceramic, 350 ml.
Sublimations Tasse, Keramik, 350 ml.
Tasse Sublimation, Céramique, 350 ml.
Sublimatie Mok, Keramiek, 350 ml.



04 02 08 06

Ø 8.2 x 9.6 cm 36
Print Code: Q

Lanteira 21092

Sublimation Mug, Ceramic, 350 ml.
Sublimations Tasse, Keramik, 350 ml.
Tasse Sublimation, Céramique, 350 ml.
Sublimatie Mok, Keramiek, 350 ml.



04 05 03

Ø 8 x 9.8 cm 36 Print Code: Q

350 ml



02

Harnet 3894

Sublimation Mug, Ceramic, 350 ml.
Sublimations Tasse, Keramik, 350 ml.
Tasse Sublimation, Céramique, 350 ml.
Sublimatie Mok, Keramiek, 350 ml.



04 07 19 03 05

Ø 8.2 x 9.6 cm 36
Print Code: Q

New

350 ml



Robleda 21091

Sublimation Mug, Ceramic, 350 ml.
Sublimations Tasse, Keramik, 350 ml.
Tasse Sublimation, Céramique, 350 ml.
Sublimatie Mok, Keramiek, 350 ml.



Ø 8.2 x 9.6 cm 36 Print Code: Q

To be Inspired



350 ml

Kaffir 5184

Sublimation Mug, Ceramic, 350 ml.
 Sublimations Tasse, Keramik, 350 ml.
 Tasse Sublimation, Céramique, 350 ml.
 Sublimatie Mok, Keramiek, 350 ml.



☞ Ø 9 x 10 cm ☞ 36 ☞ Print Code: Q



250 ml

Dolten 5183

Sublimation Mug, Ceramic, 250 ml.
 Sublimations Tasse, Keramik, 250 ml.
 Tasse Sublimation, Céramique, 250 ml.
 Sublimatie Mok, Keramiek, 250 ml.

☞ Ø 7.4 x 8.4 cm ☞ 48 ☞ Print Code: Q



350 ml

Bornel 3893

Sublimation Mug, Ceramic, 350 ml.
 Sublimations Tasse, Keramik, 350 ml.
 Tasse Sublimation, Céramique, 350 ml.
 Sublimatie Mok, Keramiek, 350 ml.

☞ Ø 8.2 x 9.6 cm ☞ 36 ☞ Print Code: Q



Heim 20513

Sublimation Jug, Ceramic, 700 ml.
 Sublimations Krug, Keramik, 700 ml.
 Carafe Sublimation, Céramique, 700 ml.
 Sublimatie Kan, Keramiek, 700 ml.

☞ Ø 10,3 × 13,8 cm ☞ 20 ☞ Print Code: Q



Gover 6287

Sublimation Mug, Ceramic, 300 ml.
 Sublimations Tasse, Keramik, 300 ml.
 Tasse Sublimation, Céramique, 300 ml.
 Sublimatie Mok, Keramiek, 300 ml.

☞ Ø 8,6 × 8,5 cm ☞ 36 ☞ Print Code: Q

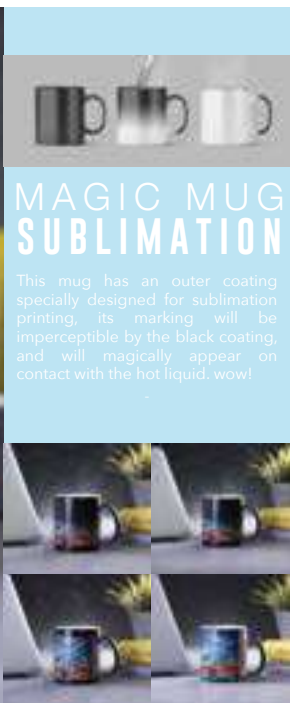

MAGIC MUG SUBLIMATION

This mug has an outer coating specially designed for sublimation printing, its marking will be imperceptible by the black coating, and will magically appear on contact with the hot liquid. wow!



Bardot 5837

Sublimation Mug, Ceramic, 350 ml.
 Sublimations Tasse, Keramik, 350 ml.
 Tasse Sublimation, Céramique, 350 ml.
 Sublimatie Mok, Keramiek, 350 ml.

☞ Ø 8,2 × 9,6 cm ☞ 36 ☞ Print Code: F(1), Q



420 ml



New

350 ml

Roset 1778

Sublimation Mug. Ceramic/ Cork. 420 ml.
 Sublimations Tasse. Keramik/ Kork. 420 ml.
 Tasse Sublimation. Céramique/ Liège. 420 ml.
 Sublimatie Mok. Keramiek/ Kurk. 420 ml.

☐ 09 x 11 cm ☑ 36 ☎ Print Code: Q



Nala 20522

Sublimation Mug. Ceramic/ Cork. 350 ml.
 Sublimations Tasse. Keramik/ Kork. 350 ml.
 Tasse Sublimation. Céramique/ Liège. 350 ml.
 Sublimatie Mok. Keramiek/ Kurk. 350 ml.

☐ 08.2 x 10.2 cm ☑ 36 ☎ Print Code: Q





Barker 1777



Sublimation Insulated Cup. Stainless Steel/ Cork. 330 ml.
 Sublimations Wärme Trinkbecher. Rostfreier Stahl/ Kork. 330 ml.
 Verre Thermique Sublimation. Acier Inox/ Liège. 330 ml.
 Sublimatie Beker-Fles. Roestvrij Staal/ Kurk. 330 ml.

Ø 8.6 x 12.4 cm 50 Print Code: L1, Q



Wifly 1776



Sublimation Insulated Mug. Stainless Steel/ Cork. 330 ml.
 Sublimations Wärme Tasse. Rostfreier Stahl/ Kork. 330 ml.
 Tasse Thermique Sublimation. Acier Inox/ Liège. 330 ml.
 Sublimatie Thermoskan-Mok. Roestvrij Staal/ Kurk. 330 ml.

Ø 8.8 x 11.7 cm 30 Print Code: L1, Q



380 ml



Kantol 6359

Sublimation Mug. Metal. 380 ml.
 Sublimations Tasse. Metall. 380 ml.
 Tasse Sublimation. Métal. 380 ml.
 Sublimatie Mok. Metaal. 380 ml.

Ø 8.8 x 7.9 cm 50 Print Code: L1, Q



380 ml



Neyms 6111

Sublimation Mug. Metal. 380 ml.
 Sublimations Tasse. Metall. 380 ml.
 Tasse Sublimation. Métal. 380 ml.
 Sublimatie Mok. Metaal. 380 ml.

Ø 8.8 x 7.9 cm 50 Print Code: Q





650 ml



500 ml



330 ml



Kallum 1791



Sublimation Insulated Cup. Stainless Steel. 650 ml.
 Sublimations Wärme Trinkbecher. Rostfreier Stahl. 650 ml.
 Verre Thermique Sublimation. Acier Inox. 650 ml.
 Sublimatie Beker-Fles. Roestvrij Staal. 650 ml.

☞ Ø 7.8 x 18.7 cm ☞ 50 ☞ Print Code: L3, Q



Cleikon 6165



Sublimation Vacuum Flask. Stainless Steel. 500 ml.
 Sublimations Thermoskanne. Rostfreier Stahl. 500 ml.
 Thermo Sublimation. Acier Inox. 500 ml.
 Sublimatie Thermosfles. Roestvrij Staal. 500 ml.

☞ Ø 7 x 24.6 cm ☞ 30 ☞ Print Code: L2, L3, Q



EASY OPENING

Alirox 6409



Sublimation Vacuum Flask. Stainless Steel. 330 ml.
 Sublimations Thermoskanne. Rostfreier Stahl. 330 ml.
 Thermo Sublimation. Acier Inox. 330 ml.
 Sublimatie Thermosfles. Roestvrij Staal. 330 ml.

☞ Ø 5.7 x 23 cm ☞ 30 ☞ Print Code: L2, L3, Q

700 ml

Bayron 6164

MANGO
JUICE

750 ml

Pooch 1775

Hingham

750 ml

Crafor 1259

MOSAIC

750 ml

Preuk 1258

M

400 ml

Greims 5341



800 ml

Bredix 1257

abcdefghijklmnopqrstuvwxyz

Bayron 6164

Sublimation Bottle. Stainless Steel. 700 mL.
 Sublimations Trinkflasche. Rostfreier Stahl. 700 mL.
 Bidon Sublimation. Acier Inox. 700 mL.
 Sublimatie Fles. Roestvrij Staal. 700 mL.

☰ Ø 7 × 27.5 cm ☰ 50 ☰ Print Code: L2, L3, Q

Pooch 1775

Sublimation Bottle. Stainless Steel/ Cork. 750 mL.
 Sublimations Trinkflasche. Rostfreier Stahl/ Kork. 750 mL.
 Bidon Sublimation. Acier Inox/ Liège. 750 mL.
 Sublimatie Fles. Roestvrij Staal/ Kurk. 750 mL.

☰ Ø 7 × 27.5 cm ☰ 50 ☰ Print Code: L2, L3, Q

Crafor 1259

Sublimation Bottle. Stainless Steel. 750 mL.
 Sublimations Trinkflasche. Rostfreier Stahl. 750 mL.
 Bidon Sublimation. Acier Inox. 750 mL.
 Sublimatie Fles. Roestvrij Staal. 750 mL.

☰ Ø 7 × 26 cm ☰ 30 ☰ Print Code: L2, L3, Q

Preuk 1258

Sublimation Bottle. Stainless Steel/ Bamboo. 750 mL.
 Sublimations Trinkflasche. Rostfreier Stahl/ Bambus. 750 mL.
 Bidon Sublimation. Acier Inox/ Bambou. 750 mL.
 Sublimatie Fles. Roestvrij Staal/ Bamboe. 750 mL.

☰ Ø 7.3 × 22.5 cm ☰ 30 ☰ Print Code: L2, L3, Q

Greims 5341

Sublimation Bottle. Aluminium. 400 mL.
 Sublimations Trinkflasche. Aluminium. 400 mL.
 Bidon Sublimation. Aluminium. 400 mL.
 Sublimatie Fles. Aluminium. 400 mL.

☰ Ø 6.6 × 17.5 cm ☰ 100/20 ☰ Print Code: L2, L3, Q

Bredix 1257

Sublimation Bottle. Aluminium. 800 mL.
 Sublimations Trinkflasche. Aluminium. 800 mL.
 Bidon Sublimation. Aluminium. 800 mL.
 Sublimatie Fles. Aluminium. 800 mL.

☰ Ø 7.3 × 25.3 cm ☰ 50 ☰ Print Code: L2, L3, Q

Double Wall

1047

SUBLIMATION LINE



Hodis 6480



Sublimation Insulated Bottle. Stainless Steel. 500 ml.
 Sublimations Wärme Flasche. Rostfreier Stahl. 500 ml.
 Bidon Thermique Sublimation. Acier Inox. 500 ml.
 Sublimatie Thermoskan-Fles. Roestvrij Staal. 500 ml.

Ø 7.3 × 22.7 cm 30
 Print Code: L2, L3, Q

Varn 1662



Sublimation Insulated Bottle. Stainless Steel. 500 ml.
 Sublimations Wärme Flasche. Rostfreier Stahl. 500 ml.
 Bidon Thermique Sublimation. Acier Inox. 500 ml.
 Sublimatie Thermoskan-Fles. Roestvrij Staal. 500 ml.

Ø 7.3 × 26.3 cm 30
 Print Code: L2, L3, Q

Ying 1382



Sublimation Insulated Bottle. Stainless Steel/ Bamboo. 500 ml.
 Sublimations Wärme Flasche. Rostfreier Stahl/ Bambus. 500 ml.
 Bidon Thermique Sublimation. Acier Inox/ Bambou. 500 ml.
 Sublimatie Thermoskan-Fles. Roestvrij Staal/ Bamboe. 500 ml.

Ø 7.1 × 22.7 cm 30 Print Code: L2, L3, Q

Jano 20738



Sublimation Insulated Bottle. Stainless Steel/ Bamboo. 500 ml.
 Sublimations Wärme Flasche. Rostfreier Stahl/ Bambus. 500 ml.
 Bidon Thermique Sublimation. Acier Inox/ Bambou. 500 ml.
 Sublimatie Thermoskan-Fles. Roestvrij Staal/ Bamboe. 500 ml.

Ø 7.3 × 26 cm 30 Print Code: L2, Q

New



Gwen 1830

Sublimation Bag, Non-Woven.
 Sublimations Tasche, Non-Woven.
 Sac Sublimation, T.N.T..
 Sublimatie Tas, Non-Woven.

38 x 35 cm

250 / 50

Print Code: F(1), N(8), R



Mirtal 4478

Sublimation Bag, Non-Woven.
 Sublimations Tasche, Non-Woven.
 Sac Sublimation, T.N.T..
 Sublimatie Tas, Non-Woven.

36 x 40 cm

400 / 20

Print Code: F(1), N(8), R



Godon 1831

Sublimation Bag, Non-Woven.
 Sublimations Tasche, Non-Woven.
 Sac Sublimation, T.N.T..
 Sublimatie Tas, Non-Woven.

35 x 40 x 15 cm

200 / 10

Print Code: F(1), N(8), R



Wercal 6115

Sublimation Bag, Non-Woven.
 Sublimations Tasche, Non-Woven.
 Sac Sublimation, T.N.T..
 Sublimatie Tas, Non-Woven.

34 x 43 cm

400 / 20

Print Code: F(1), N(8), R



Spook 3164

Drawstring Bag, Polyester 210T.
Rucksack, Polyester 210T.
Sac à Dos, Polyester 210T.
Rugzak, Polyester 210T.

34 x 42 cm 300 / 50 Print Code: F(1), N(8), R



Prosum 6431

Sublimation Bag, Polyester.
Sublimations Tasche, Polyester.
Sac Sublimation, Polyester.
Sublimatie Tas, Polyester.

38 x 42 cm 100 / 10 Print Code: F(1), N(8), R

SoftTouch^{material}



Kreston 6433

Sublimation Beauty Bag, Polyester.
Sublimations Kosmetik Tasche, Polyester.
Nécessaire Sublimation, Polyester.
Sublimatie Toilettas, Polyester.

22 x 14 x 6,5 cm 500 / 10 Print Code: F(1), N(8), R



Lizcom 6432

Sublimation Drawstring Bag, Polyester.
Sublimations Rucksack, Polyester.
Sac à Dos Sublimation, Polyester.
Sublimatie Rugzak, Polyester.

34 x 42 cm 100 / 10 Print Code: F(1), N(8), R



Cherin 4215

Neck Warmer. Polyester.
Nacken Wärmer. Polyester.
Tour de Cou. Polyester.
Colsjaal. Polyester.



25 x 50 cm 300 / 100 Print Code: G(1), N(8), R

Plus 3029

Neckerchief. Polyester 170T.
Halstuch. Polyester 170T.
Foulard. Polyester 170T.
Bandana. Polyester 170T.

100 x 70 cm 1000 / 10 Print Code: F(1), N(8), R

Flecher 1537

Cap. Cotton/ Polyester. 5 Panels. Plastic Closure.
Mütze. Baumwolle/ Polyester. 5 Panels. Plastik Verschluss.
Casquette. Coton/ Polyester. 5 Panneaux. Fermeture Plastique.
Pet. Katoen/ Polyester. 5 Panelen. Kunststof Sluiting.

Consult. 200 / 50
 Print Code: N(8), O, R



Piodox 1918

Sublimation Sock. Polyester. Size L-XL.
Sublimations Socken. Polyester. Grösse L-XL.
Chaussette Sublimation. Polyester. Taille L-XL.
Sublimatie Sok. Polyester. Maat L-XL.

40 x 8.5 cm 300 / 10 Print Code: N(8), R



Sakam 1919

Sublimation Sock. Polyester. Size S-M.
Sublimations Socken. Polyester. Grösse S-M.
Chaussette Sublimation. Polyester. Taille S-M.
Sublimatie Sok. Polyester. Maat S-M.

35 x 8 cm 400 / 10 Print Code: N(8), R



Special! Sublimation





Waylen 5852

Sublimation Bracelet, Polyester.
Sublimations Armband, Polyester.
Bracelet Sublimation, Polyester.
Sublimatie Armband, Polyester.

 30 x 1.5 cm  Print Code: R

Nopak 5454

Sublimation Lanyard, Polyester.
Sublimations Schlüsselband, Polyester.
Lanyard Sublimation, Polyester.
Sublimatie Lanyard, Polyester.

 2.5 x 50 cm  500 / 100  Print Code: R

Lerop 2598

Sublimation Lanyard, Polyester.
Sublimations Schlüsselband, Polyester.
Lanyard Sublimation, Polyester.
Sublimatie Lanyard, Polyester.

 2.5 x 100 cm  500  Print Code: R



New

Ranta 20740

Sublimation Travel Eye Mask. Soft Shell.
 Sublimations Reise Augenmaske. Soft Shell.
 Masque Voyage Sublimation. Soft Shell.
 Sublimatie Slaapmasker. Soft Shell.

18.5 x 8 cm 1000 / 50 Print Code: R



Gildor 4386

Cleaner Cloth. Microfibre/ Polyester.
 Putztuch. Mikrofaser/ Polyester.
 Chiffon Nettoyant. Microfibre/ Polyester.
 Schoonmaakdoekje. Microfibre/ Polyester.

18 x 15 cm 2000 / 100 Print Code: E(1), R



Ekain 4390

Pouch. Polyester.
 Hülle. Polyester.
 Étui. Polyester.
 Hoes. Polyester.

9 x 18 cm 1000 / 50
 Print Code: D(1), N(8), R



Groly 20946

Sublimation Notepad. Polyester 600D RPET. Hard Cover. 100 Sheets.
 Sublimations Notzblock. Polyester 600D RPET. Hardcover-Abdeckung. 100 Blätter.
 Bloc Notes Sublimation. Polyester 600D RPET. Couverture Rigide. 100 Feuilles.
 Sublimatie Nottieblokje. Polyester 600D RPET. Harde Kaft. 100 Bladjes.

14.7 x 21 x 1.5 cm 50 / 25 Print Code: E(4), N(8), R



Lury 20741

Sublimation Laptop Pouch. Soft Shell.
 Sublimations Laptop-Tasche. Soft Shell.
 Housse pour Ordinateur Portable Sublimation. Soft Shell.
 Sublimatie Laptotasje. Soft Shell.

41 x 30 cm 50 / 10 Print Code: R



Minet 6140

Mousepad. Polyester/ Silicone. Padded
 Wrist Rest. Anti-Slip.
 Mauspad. Polyester/ Silikon. Gepolsterter
 Palmrest. Rutschfest.
 Tapis Souris. Polyester/ Silicone. Repose-
 Mains Rembourrée. Antidérapant.
 Muispad. Polyester/ Siliconen. Gewatteerd
 Polssteun. Anti-Slip.

20.5 x 24.3 cm 100
 Print Code: E(1), N(8), R



Roland 5520

Mousepad. Polyester/ Silicone. Anti-Slip.
 Mauspad. Polyester/ Silikon. Rutschfest.
 Tapis Souris. Polyester/ Silicone. Antidérapant.
 Muispad. Polyester/ Siliconen. Anti-Slip.

Ø 20 cm 250 / 50 Print Code: E(1), N(8), R



Vaniat 4387

Mousepad. Polyester/ Silicone. Anti-Slip.
 Mauspad. Polyester/ Silikon. Rutschfest.
 Tapis Souris. Polyester/ Silicone. Antidérapant.
 Muispad. Polyester/ Siliconen. Anti-Slip.

22 x 18 cm 250 / 50 Print Code: E(1), N(8), R



02

19

Silax 5215

Kitchen Mitten. 100% Polyester. One Flat Side for Printing.
 Küchenhandschuh. 100% Polyester. Eine flache Seite zum Bedrucken.
 Gant Cuisine. 100% Polyester. Un Côté Lisse pour Impression.
 Ovenwant. 100% Polyester. Eén Platte Zijde Voor Bedrukking.

18 x 28 cm 200 / 50 Print Code: F(1), N(8), R



03

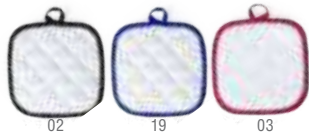

02

19

03

Kalmont 5214

Pot Holder. 100% Polyester. One Flat Side for Printing.
 Topflappen. 100% Polyester. Eine flache Seite zum Bedrucken.
 Manique. 100% Polyester. Un Côté Lisse pour Impression.
 Pannenvlap. 100% Polyester. Eén Platte Zijde Voor Bedrukking.

17 x 17 cm 200 / 50 Print Code: E(1), N(8), R



02



Lebron 6116

Sublimation Place Mat. Non-Woven.
 Sublimations Matte. Non-Woven.
 Set Table Sublimation. T.N.T..
 Sublimatie Placemat. Non-Woven.

40 x 30 x 0.1 cm 1000 / 50
 Print Code: E(1), N(8), R



Salmux 6114

Sublimation Apron. Non-Woven.
 Sublimations Schürze. Non-Woven.
 Tablier Sublimation. T.N.T..
 Sublimatie Schort. Non-Woven.



50 x 73 cm 200 / 50
 Print Code: F(1), N(8), R





Korenty 1596

Sunshade. Polyester. 2 Pieces. Foldable. Polyester Pouch.
Autosonnenschutz. Polyester. 2 Stück. Faltbar. Polyester Etui.
Pare-Soleil. Polyester. 2 Pièces. Pliable. Étui Polyester.
Zonnescherm. Polyester. 2 Stuks. Opvouwbaar. Polyester Zakje.

 44 x 36 cm  200  Print Code: G(1), R



New

 THICKNESS
0,6 cm

Zaxia 20739

Sublimation Beach Rackets. Wood/ Wheat Straw/ PP.
Sublimations Strand Schläger. Holz/ Weizenstroh/ PP.
Raquette Plage Sublimation. Bois/ Paille de Blé/ PP.
Sublimatie Strand Rackets. Hout/ Tarwestro/ PP.

 19 x 33 x 0.6 cm  36  Print Code: L2, R



Olbran 1607

Pai Pai. Bamboo/ Polyester.
Pay-Pay. Bambus/ Polyester.
Pai Pai. Bamboo/ Polyester.
Pai Pai. Bamboe/ Polyester.

 24 x 35 x 0.9 cm  100 / 10  Print Code: E(1), L1, N(8), R



Badrak 1752

Sublimation Flip Flops. EVA/ PVC/ Polyester. Sizes: 36-38, 42-44.
Sublimations Flip Flop. EVA/ PVC/ Polyester. Größen: 36-38, 42-44.
Tongues Sublimation. EVA/ PVC/ Polyester. Tailles: 36-38, 42-44.
Sublimatie Flip Flops. EVA/ PVC/ Polyester. Maat: 36-38, 42-44.

 36-38, 42-44  20  Print Code: G(1), R



29 PACKAGING





**MAKE A DIFFERENCE,
CUSTOMIZE YOUR PACKAGING.**

MARCA LA DIFERENCIA,
MARCA TU PACKAGING.

 **asiaexpress**
DIRECT IMPORTS SERVICE



Quimod 1561



Sulim 1560



Teiker 1559



Bags Recycled Paper

Quimod 1561



Bag, Recycled Paper 50 g/ m².
Tasche, Recycling Papier 50 g/ m².
Sac, Papier Recyclé 50 g/ m².
Tas, Gerecycled Papier 50 g/ m².

 25 x 32 cm  1000  Print Code: A(1)



Sulim 1560



Bag, Recycled Paper 50 g/ m².
Tasche, Recycling Papier 50 g/ m².
Sac, Papier Recyclé 50 g/ m².
Tas, Gerecycled Papier 50 g/ m².

 15 x 23 cm  3000  Print Code: A(1)



Teiker 1559

Bag, Recycled Paper 50 g/ m².
Tasche, Recycling Papier 50 g/ m².
Sac, Papier Recyclé 50 g/ m².
Tas, Gerecycled Papier 50 g/ m².

 9 x 14.5 cm  3500  Print Code: A(1)



gift box

1059

PACKAGING

Bexer 20348

Gift Box. Wood.
Geschenk-Box. Holz.
Boîte de Présentation. Bois.
Geschenkendoos. Hout.

 8.5 x 8.5 x 4.5 cm  300 / 50  Print Code: D(4), L1



New

New

Abedi 20347

Gift Box. Wood.
Geschenk-Box. Holz.
Boîte de Présentation. Bois.
Geschenkendoos. Hout.

 Ø 8.5 x 4.3 cm  300 / 50  Print Code: D(4), L1



Recycled Cardboard

Boxit 1314

Gift Box. Recycled Cardboard.
Geschenk-Box. Recycling Pappe.
Boîte de Présentation. Carton Recyclé.
Geschenkendoos. Gerecycled Karton.

 22.5 x 5.7 x 14 cm  400 / 100  Print Code: C(1)



Handru 1315

Gift Box. Recycled Cardboard.
Geschenk-Box. Recycling Pappe.
Boîte de Présentation. Carton Recyclé.
Geschenkendoos. Gerecycled Karton.

 14.5 x 3.7 x 12.7 cm  600 / 100  Print Code: C(1)



Recycled
Cardboard

Recycled Cardboard



Kuolux 1553

Gift Box. Recycled Corrugated Cardboard.
Geschenk-Box. Recycling Wellpappe.
Boîte de Présentation. Carton Ondulé Recyclé.
Geschenkeendoos. Gerecycled Golfkarton.

8 × 26.7 × 8 cm Print Code: D(1)

Avider 1552

Gift Box. Recycled Corrugated Cardboard.
Geschenk-Box. Recycling Wellpappe.
Boîte de Présentation. Carton Ondulé Recyclé.
Geschenkeendoos. Gerecycled Golfkarton.

12 × 10.6 × 9 cm Print Code: D(1)



IDEA FOR GIFT SET,
ITEMS NOT INCLUDED

Wingard 1551

Gift Box. Recycled Corrugated Cardboard.
Geschenk-Box. Recycling Wellpappe.
Boîte de Présentation. Carton Ondulé Recyclé.
Geschenkeendoos. Gerecycled Golfkarton.

21 × 5 × 25 cm Print Code: D(1)

Magdus 1549

Gift Box. Recycled Corrugated Cardboard.
Geschenk-Box. Recycling Wellpappe.
Boîte de Présentation. Carton Ondulé Recyclé.
Geschenkeendoos. Gerecycled Golfkarton.

26.5 × 9 × 30 cm Print Code: D(1)

Fissur 1550

Gift Box. Recycled Corrugated Cardboard.
Geschenk-Box. Recycling Wellpappe.
Boîte de Présentation. Carton Ondulé Recyclé.
Geschenkeendoos. Gerecycled Golfkarton.

16.6 × 8.9 × 15.3 cm Print Code: C(1)

Recycled Cardboard

Badesy 1497

Gift Box. Recycled Corrugated Cardboard.
Geschenk-Box. Recycling Wellpappe.
Boîte de Présentation. Carton Ondulé Recyclé.
Geschenkendoos. Gerecycled Golfkarton.

 8 x 26.7 x 8 cm  Print Code: D(1)



Badesy 1497

Jikory 1496

Gift Box. Recycled Corrugated Cardboard.
Geschenk-Box. Recycling Wellpappe.
Boîte de Présentation. Carton Ondulé Recyclé.
Geschenkendoos. Gerecycled Golfkarton.

 12 x 10.6 x 9 cm  Print Code: D(1)

Jikory 1496



IDEA FOR GIFT SET,
ITEMS NOT INCLUDED



Ciril 1313

Gift Box. Recycled Corrugated Cardboard.
Geschenk-Box. Recycling Wellpappe.
Boîte de Présentation. Carton Ondulé Recyclé.
Geschenkendoos. Gerecycled Golfkarton.

 16 x 8.5 x 15 cm  Print Code: C(1)

Fredox 1309

Gift Box. Recycled Corrugated Cardboard.
Geschenk-Box. Recycling Wellpappe.
Boîte de Présentation. Carton Ondulé Recyclé.
Geschenkendoos. Gerecycled Golfkarton.

 26.5 x 9 x 30 cm  Print Code: D(1)

Ayira 1310

Gift Box. Recycled Corrugated Cardboard.
Geschenk-Box. Recycling Wellpappe.
Boîte de Présentation. Carton Ondulé Recyclé.
Geschenkendoos. Gerecycled Golfkarton.

 21 x 5 x 25 cm  Print Code: D(1)

WITH
ELASTIC

IDEA FOR GIFT
ITEMS NOT INCLUDED

Canlia 1311

Gift Hangtag, Recycled Cardboard.
Geschenk-Hangtag, Recycling Pappe.
Hangtag de Présentation, Carton Recyclé.
Geschenk Hangtag, Gerecycled Karton.

5 x 8 cm 3000 / 100 Print Code: A(4)

SET
PRICE

Kotix 1312

Card, Recycled Cardboard.
Karte, Recycling Pappe.
Carte, Carton Recyclé.
Kaart, Gerecycled Karton.

15 x 10 cm 2000 / 200
 Print Code: A(4)



Qualix 1562

Gift Hangtags Set, Recycled Cardboard, 10 Pieces.
Geschenk-Hangtags Set, Recycling Pappe, 10 Stück.
Set Etiquettes de Présentation, Carton Recyclé, 10 Pièces.
Geschenk Hangtags Set, Gerecycled Karton, 10 Stuks.

5.5 x 10 x 2.5 cm 200 / 50 Print Code: B(1), A(4)





Topak 1558



Rubrux 1557



Kannus 1556



Topak 1558

Gift Box. Metal.
Geschenk-Box. Metall.
Boîte de Présentation. Métal.
Geschenkendoos. Metaal.

9 × 5 × 9 cm 100 / 50
Print Code: F(1), L2

Rubrux 1557

Gift Box. Metal.
Geschenk-Box. Metall.
Boîte de Présentation. Métal.
Geschenkendoos. Metaal.

Ø 8.5 × 5 cm 100 / 50
Print Code: F(1), L2

Kannus 1556

Gift Box. Metal.
Geschenk-Box. Metall.
Boîte de Présentation. Métal.
Geschenkendoos. Metaal.

Ø 8.5 × 28 cm 20
Print Code: F(1), L2

Experience 6661

Gift Box. Metal.
Geschenk-Box. Metall.
Boîte de Présentation. Métal.
Geschenkendoos. Metaal.

33.5 × 13.3 × 18.5 cm 10
Print Code: F(1), L2

RECYCLED COTTON



10 x 14 cm



25 x 30 cm



15 x 21 cm

Dratinix 1452

Bag. 100% Recycled Cotton 120 g/ m².
Tasche. 100% Recycling Baumwolle 120 g/ m².
Sac. 100% Coton Recyclé 120 g/ m².
Tas. 100% Gerecycled Katoen 120 g/ m².

10 x 14 cm 500 / 50
Print Code: F(1), N(8)



Murfix 1179

Bag. 100% Recycled Cotton 120 g/ m².
Tasche. 100% Recycling Baumwolle 120 g/ m².
Sac. 100% Coton Recyclé 120 g/ m².
Tas. 100% Gerecycled Katoen 120 g/ m².

25 x 30 cm 500 / 50
Print Code: F(1), N(8)

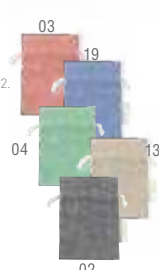

Karzak 1178

Bag. 100% Recycled Cotton 120 g/ m².
Tasche. 100% Recycling Baumwolle 120 g/ m².
Sac. 100% Coton Recyclé 120 g/ m².
Tas. 100% Gerecycled Katoen 120 g/ m².

15 x 21 cm 500 / 50
Print Code: F(1), N(8)

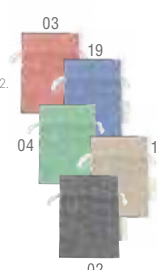

The Fairtrade Cotton label guarantees that the product comes from a traceable and sustainable sourcing chain and helps us to identify garments where 100% of the composition is traceable Fairtrade cotton. All of the cotton is Fairtrade certified, traded, audited and sourced from Fairtrade producers.

Visit www.info.fairtrade.net



Lovan Fairtrade 20779

Bag. 100% Cotton 105 g/ m².
Tasche. 100% Baumwolle 105 g/ m².
Sac. 100% Coton 105 g/ m².
Tas. 100% Katoen 105 g/ m².

15 x 21 cm 500 / 50
Print Code: F(6), N(8), O, P



Kaiki Fairtrade 20778

Bag. 100% Cotton 105 g/ m².
Tasche. 100% Baumwolle 105 g/ m².
Sac. 100% Coton 105 g/ m².
Tas. 100% Katoen 105 g/ m².

25 x 30 cm 500 / 50
Print Code: F(6), N(8), O, P



Marcex 6624

Bottle Bag, 100% Cotton 105 g/ m².
 Trinkflasche Tasche, 100% Baumwolle 105 g/ m².
 Sac. Bouteille, 100% Coton 105 g/ m².
 Fles Tas, 100% Katoen 105 g/ m².



12 x 33 cm 500 / 50 Print Code: F(6), N(8), O

IDEAL FOR BOTTLES AND VACUUM FLASK

12 x 33 cm

Marcex 6624

Miley 1177

30 x 45 cm

25 x 30 cm

Seaking 1451

10 x 14 cm

Fergut 6622

15 x 21 cm

Jardix 6623

Seaking 1451

Bag, 100% Cotton 105 g/ m².
 Tasche, 100% Baumwolle 105 g/ m².
 Sac, 100% Coton 105 g/ m².
 Tas, 100% Katoen 105 g/ m².

10 x 14 cm 500 / 50
 Print Code: F(6), N(8), O

Fergut 6622

Bag, 100% Cotton 105 g/ m².
 Tasche, 100% Baumwolle 105 g/ m².
 Sac, 100% Coton 105 g/ m².
 Tas, 100% Katoen 105 g/ m².

15 x 21 cm 500 / 50
 Print Code: F(6), N(8), O, P

Jardix 6623

Bag, 100% Cotton 105 g/ m².
 Tasche, 100% Baumwolle 105 g/ m².
 Sac, 100% Coton 105 g/ m².
 Tas, 100% Katoen 105 g/ m².

25 x 30 cm 500 / 50
 Print Code: F(6), N(8), O, P

Miley 1177

Bag, 100% Cotton 105 g/ m².
 Tasche, 100% Baumwolle 105 g/ m².
 Sac, 100% Coton 105 g/ m².
 Tas, 100% Katoen 105 g/ m².

30 x 45 cm 200 / 50
 Print Code: F(6), N(8), O, P

100%
Cotton

NATURAL JUTE



Lesky 6823



Vagan 6824

Vagan 6824

Bag. Jute.
Tasche. Jutestoff.
Sac. Jute.
Tas. Jute.

25 x 30 cm 200 / 50 Print Code: F(1), N(8)

Lesky 6823

Bag. Jute.
Tasche. Jutestoff.
Sac. Jute.
Tas. Jute.

16 x 20 cm 300 / 50 Print Code: F(1), N(8)



18



06



13



02

06

13

Pidrum 1555

Bag. Polyester.
Tasche. Polyester.
Sac. Polyester.
Tas. Polyester.

15 x 21 cm 1000 / 50 Print Code: F(1), N(8)



18

02

Yastrin 1554

Bag. Polyester.
Tasche. Polyester.
Sac. Polyester.
Tas. Polyester.

10 x 14 cm 1000 / 50 Print Code: F(1), N(8)



19

02

11

01

03

Dacrok 5901

Bag. Polyester.
Tasche. Polyester.
Sac. Polyester.
Tas. Polyester.

10 x 14 cm 1000 / 50 Print Code: E(1), N(8)



Kiping 4221

Bag. Polyester.
Tasche. Polyester.
Sac. Polyester.
Tas. Polyester.

9.5 x 10 cm 3000 / 100
Print Code: E(1), N(8)



Hidra 4227

Bag. Velvet.
Tasche. Wildleder.
Sac. Suédine.
Tas. Fluweel.

8 x 10 cm 2000 / 50
Print Code: E(1), N(8)



IDEAL FOR BACKPACKS



Cuper 5438

Bag. Non-Woven.
Tasche. Non-Woven.
Sac. T.N.T.
Tas. Non-Woven.

46 x 59 cm 200 / 20 Print Code: F(1)



Varien 4774

Bag. Non-Woven.
Tasche. Non-Woven.
Sac. T.N.T.
Tas. Non-Woven.

16 x 40 x 6.5 cm 1000 / 50
Print Code: F(1)



18

Varien 4774

Bag. Non-Woven.
Tasche. Non-Woven.
Sac. T.N.T.
Tas. Non-Woven.



20

02

06

16 x 40 x 6.5 cm 1000 / 50 Print Code: F(1)

Ragnar 5487

Bag. Recycled Paper 100 g/ m².
Tasche. Recycling Papier 100 g/ m².
Sac. Papier Recyclé 100 g/ m².
Tas. Gerecycled Papier 100 g/ m².



11 x 36 x 10 cm 500 / 100 Print Code: F(1)

Holden 3480

Bag. Laminated Jute.
Tasche. Laminiertes Jutestoff.
Sac. Jute Laminé.
Tas. Gelamineerd Jute.



10.5 x 35.5 x 10 cm 150 / 25 Print Code: G(1), N(8)

Koop 3481

Bag. Laminated Jute.
Tasche. Laminiertes Jutestoff.
Sac. Jute Laminé.
Tas. Gelamineerd Jute.



20 x 34.5 x 10 cm 100 / 25 Print Code: G(1), N(8)

Minax 6953

Bag. Cork.
Tasche. Kork.
Sac. Liège.
Tas. Kurk.



10 x 33 x 10 cm 200 / 25 Print Code: F(1), N(8)

Yaiza 6990

Bag. Canvas 220 g/ m².
Tasche. Canvas 220 g/ m².
Sac. Canvas 220 g/ m².
Tas. Canvas 220 g/ m².



8 x 31 x 8 cm 200 / 20 Print Code: F(1), N(8)



Dorkus 1666

Gift Box. Wood.
Geschenk-Box. Holz.
Boîte de Présentation. Bois.
Geschenkendoos. Hout.

34,7 x 11,2 x 28,5 cm 5 Print Code: F(1), L2



Grimbur 1943

Gift Box. Wood.
Geschenk-Box. Holz.
Boîte de Présentation. Bois.
Geschenkendoos. Hout.

10 x 35 x 10 cm 15 Print Code: F(1), L2



Plesnik 1652

Bag. Polyester.
Tasche. Polyester.
Sac. Polyester.
Tas. Polyester.

Ø 8 x 34 cm 500 / 10 Print Code: F(1), N(8)



Drazen 1651

Bag. 100% Coton Organique/ Cork.
Tasche. 100% Organische Baumwolle/ Kork.
Sac. 100% Coton Organique/ Liège.
Tas. 100% Organisch Katoen/ Kurk.

Ø 8 x 34 cm 400 / 10 Print Code: F(1), N(8)



Majan 20785

Gift Box. Wood.
Geschenk-Box. Holz.
Boîte de Présentation. Bois.
Geschenkendoos. Hout.

Ø 8 x 34 cm 30 Print Code: E(1)



30 TEXTILE







GARMENTS FOR EVERYONE

The models, colors, sizes and prices for all kind of events and promotions.



makito
THE FUTURE

FRUIT & LOOM.
THE BRAND

THE PRICE





Tecnic Kannur 21155 135 GSM

Adult T-Shirt, 100% Polyester 135 g/ m2. Breathable.
 Erwachsene T-Shirt, 100% Polyester 135 g/ m2. Atmungsaktiv.
 T-Shirt Adulte, 100% Polyester 135 g/ m2. Respirant.
 T-Shirt Volwassene, 100% Polyester 135 g/ m2. Ademend.

XS, S, M, L, XL, XXL 80 Print Code: F(6), M, N(8), O, P, R

Tecnic Kassar 21149 135 GSM

Adult T-Shirt, 100% Polyester RPET 135 g/ m2. Breathable.
 Erwachsene T-Shirt, 100% Polyester RPET 135 g/ m2. Atmungsaktiv.
 T-Shirt Adulte, 100% Polyester RPET 135 g/ m2. Respirant.
 T-Shirt Volwassene, 100% Polyester RPET 135 g/ m2. Ademend.

XS, S, M, L, XL, XXL 80 Print Code: F(6), N(8), O, P



Polyester Mesh Fabric

1075

makito



Tecnic Gelang 21164 135 GSM

Adult T-Shirt. 100% Polyester 135 g/ m2. Breathable.
 Erwachsene T-Shirt. 100% Polyester 135 g/ m2. Atmungsaktiv.
 T-Shirt Adulte. 100% Polyester 135 g/ m2. Respirant.
 T-Shirt Volwassenene. 100% Polyester 135 g/ m2. Ademend.

XS, S, M, L, XL, XXL 80 Print Code: F(6), N(8), O, P



Tecnic Filmur 21156 135 GSM

Adult T-Shirt. 100% Polyester 135 g/ m2. Breathable.
 Erwachsene T-Shirt. 100% Polyester 135 g/ m2. Atmungsaktiv.
 T-Shirt Adulte. 100% Polyester 135 g/ m2. Respirant.
 T-Shirt Volwassenene. 100% Polyester 135 g/ m2. Ademend.

XS, S, M, L, XL, XXL 100 / 10 Print Code: F(6), M, N(8), O, P, R

Polyester Pique Fabric



Tecnic Plus 4185 135 GSM

Kids T-Shirt. 100% Polyester 135 g/ m2. Breathable.
Kinder T-Shirt. 100% Polyester 135 g/ m2. Atmungsaktiv.
T-Shirt enfant. 100% Polyester 135 g/ m2. Respirant.
Kinder T-Shirt. 100% Polyester 135 g/ m2. Ademend.

Print Code: F(6), N(8), M, O, P, R

Tecnic Plus 4186 135 GSM

Women T-Shirt. 100% Polyester 135 g/ m2. Breathable.
Frauen T-Shirt. 100% Polyester 135 g/ m2. Atmungsaktiv.
T-Shirt Femme. 100% Polyester 135 g/ m2. Respirant.
Dames T-Shirt. 100% Polyester 135 g/ m2. Ademend.

Print Code: F(6), M, N(8), O, P, R

Polyester Pique Fabric

1077

makito



Tecnic Plus 4184

135 GSM

Adult T-Shirt. 100% Polyester 135 g/ m2. Breathable.
 Erwachsene T-Shirt. 100% Polyester 135 g/ m2. Atmungsaktiv.
 T-Shirt Adulte. 100% Polyester 135 g/ m2. Respirant.
 T-Shirt Volwassene. 100% Polyester 135 g/ m2. Ademend.

S, M, L, XL, XXL 80 / 10 Print Code: F(6), N(8), M, O, P, R



FLUORESCENT

Polyester Mesh Fabric



Tecnic Sappor 21159 135 GSM

Kids T-Shirt. 100% Polyester 135 g/ m2. Breathable.
 Kinder T-Shirt. 100% Polyester 135 g/ m2. Atmungsaktiv.
 T-Shirt enfant. 100% Polyester 135 g/ m2. Respirant.
 Kinder T-Shirt. 100% Polyester 135 g/ m2. Ademend.

4-5, 6-8, 10-12 100 Print Code: F(6), M, N(8), O, P, R

Tecnic Sappor 21158 135 GSM

Women T-Shirt. 100% Polyester 135 g/ m2. Breathable.
 Frauen T-Shirt. 100% Polyester 135 g/ m2. Atmungsaktiv.
 T-Shirt Femme. 100% Polyester 135 g/ m2. Respirant.
 Dames T-Shirt. 100% Polyester 135 g/ m2. Ademend.

S, M, L, XL 100 Print Code: F(6), M, N(8), O, P, R

Polyester Mesh Fabric

New



Tecnic Sappor 21157 135 GSM

Adult T-Shirt. 100% Polyester 135 g/ m2. Breathable.
Erwachsene T-Shirt. 100% Polyester 135 g/ m2. Atmungsaktiv.
T-Shirt Adulte. 100% Polyester 135 g/ m2. Respirant.
T-Shirt Volwassene. 100% Polyester 135 g/ m2. Ademend.

S, M, L, XL, XXL 80 Print Code: F(6), M, N(8), O, P, R



1080

makito

Polyester
POINTEL-HONEYCOMB FABRIC



Tecnic Rox 5249 135 GSM

Kids T-Shirt. 100% Polyester 135 g/ m2. Breathable.
Kinder T-Shirt. 100% Polyester 135 g/ m2. Atmungsaktiv.
T-Shirt Enfant. 100% Polyester 135 g/ m2. Respirant.
Kinder T-Shirt. 100% Polyester 135 g/ m2. Ademend.

4-5, 6-8, 10-12 100 / 10 Print Code: F(6), N(8), M, O, P, R

Tecnic Rox 5248 135 GSM

Women T-Shirt. 100% Polyester 135 g/ m2. Breathable.
Frauen T-Shirt. 100% Polyester 135 g/ m2. Atmungsaktiv.
T-Shirt Femme. 100% Polyester 135 g/ m2. Respirant.
Dames T-Shirt. 100% Polyester 135 g/ m2. Ademend.

S, M, L, XL 100 / 10 Print Code: F(6), N(8), M, O, P, R



Polyester
 POINTEL-HONEYCOMB FABRIC

1081

makito



Tecnic Rox 5247

135 GSM

Adult T-Shirt, 100% Polyester 135 g/ m2. Breathable.
 Erwachsene T-Shirt, 100% Polyester 135 g/ m2. Atmungsaktiv.
 T-Shirt Adulte, 100% Polyester 135 g/ m2. Respirant.
 T-Shirt Volwassene, 100% Polyester 135 g/ m2. Ademend.

Print Code: F(6), N(8), M, O, P, R



05F 07F
 FLUORESCENT

New



New



Tecnic Katsu 21152 135 GSM

Adult T-Shirt, 100% Polyester 135 g/ m2. Breathable.
 Erwachsene T-Shirt, 100% Polyester 135 g/ m2. Atmungsaktiv.
 T-Shirt Adulte, 100% Polyester 135 g/ m2. Respirant.
 T-Shirt Volwassene, 100% Polyester 135 g/ m2. Ademend.

XS, S, M, L, XL, XXL 80 Print Code: F(6), N(8), O, P

Tecnic Baraky 21151 135 GSM

Adult T-Shirt, 100% Polyester 135 g/ m2. Breathable.
 Erwachsene T-Shirt, 100% Polyester 135 g/ m2. Atmungsaktiv.
 T-Shirt Adulte, 100% Polyester 135 g/ m2. Respirant.
 T-Shirt Volwassene, 100% Polyester 135 g/ m2. Ademend.

XS, S, M, L, XL, XXL 80 Print Code: F(6), N(8), O, P



Polyester
Mesh Fabric



Tecnic Ulken 21163 140 GSM

Adult T-Shirt, 100% Polyester 140 g/ m2. Breathable.
 Erwachsene T-Shirt, 100% Polyester 140 g/ m2. Atmungsaktiv.
 T-Shirt Adulte, 100% Polyester 140 g/ m2. Respirant.
 T-Shirt Volwassenene, 100% Polyester 140 g/ m2. Ademend.

XS, S, M, L, XL, XXL 80 Print Code: F(6), N(8), O, P

Tecnic Tingyi 21150 135 GSM

Adult T-Shirt, 100% Polyester 135 g/ m2. Breathable.
 Erwachsene T-Shirt, 100% Polyester 135 g/ m2. Atmungsaktiv.
 T-Shirt Adulte, 100% Polyester 135 g/ m2. Respirant.
 T-Shirt Volwassenene, 100% Polyester 135 g/ m2. Ademend.

XS, S, M, L, XL, XXL 80 Print Code: F(6), N(8), O, P



Tecnic Dynamic 6221



- TECHNICAL FABRIC
- BREATHABLE
- ACTION DRY
- CREASE FREE
- REMOVABLE LABEL
- WHITE COLOUR SUITABLE FOR SUBLIMATION

Tecnic Troser 6459



Adult T-Shirt. Polyester/ Elastane 135 g/ m2. Breathable.
 Erwachsene T-Shirt. Polyester/ Elastan 135 g/ m2. Atmungsaktiv.
 T-Shirt Adulte. Polyester/ Élasthane 135 g/ m2. Respirant.
 T-Shirt Volwassene. Polyester/ Elastaan 135 g/ m2. Ademend.

S, M, L, XL, XXL 80 / 10
 Print Code: F(6), M, N(8), O, P, R

135 GSM

Tecnic Dynamic 6221



Adult T-Shirt. 100% Polyester 135 g/ m2. Breathable.
 Erwachsene T-Shirt. 100% Polyester 135 g/ m2. Atmungsaktiv.
 T-Shirt Adulte. 100% Polyester 135 g/ m2. Respirant.
 T-Shirt Volwassene. 100% Polyester 135 g/ m2. Ademend.

S, M, L, XL, XXL 80 / 10
 Print Code: F(6), N(8), M, O, P, R

135 GSM

- TECHNICAL FABRIC
- BREATHABLE
- ACTION DRY
- CREASE FREE
- REMOVABLE LABEL
- WHITE COLOUR SUITABLE FOR SUBLIMATION
- UNISEX

Tecnic Dynamic 6222



Kids T-Shirt. 100% Polyester 135 g/ m2. Breathable.
 Kinder T-Shirt. 100% Polyester 135 g/ m2. Atmungsaktiv.
 T-Shirt Enfant. 100% Polyester 135 g/ m2. Respirant.
 Kinder T-Shirt. 100% Polyester 135 g/ m2. Ademend.

4-5, 6-8, 10-12 100 / 10
 Print Code: F(6), N(8), M, O, P, R

135 GSM

- TECHNICAL FABRIC
- BREATHABLE
- ACTION DRY
- CREASE FREE
- REMOVABLE LABEL
- WHITE COLOUR SUITABLE FOR SUBLIMATION
- UNISEX



Tecnic Dynamic 6222

RPET



1085

makito



Rits 8004 135 GSM

Adult T-Shirt. 100% Polyester RPET 135 g/ m2. Breathable.
 Erwachsene T-Shirt. 100% Polyester RPET 135 g/ m2. Atmungsaktiv.
 T-Shirt Adulte. 100% Polyester RPET 135 g/ m2. Respirant.
 T-Shirt Volwassenene. 100% Polyester RPET 135 g/ m2. Ademend.

 XS, S, M, L, XL, XXL  100 / 5  Print Code: F(6), N(8), O, P



Tecnic Markus 6461 135 GSM

Adult T-Shirt. 100% Polyester RPET 135 g/ m2. Breathable.
 Erwachsene T-Shirt. 100% Polyester RPET 135 g/ m2. Atmungsaktiv.
 T-Shirt Adulte. 100% Polyester RPET 135 g/ m2. Respirant.
 T-Shirt Volwassenene. 100% Polyester RPET 135 g/ m2. Ademend.

 XS, S, M, L, XL, XXL  80 / 10  Print Code: F(6), M, N(8), O, P, R



New



Parisix 21113

Trainers. Polyester/TPR.
Sneaker. Polyester/TPR.
Baskets. Polyester/TPR.
Sportschoenen. Polyester/TPR.

36, 37, 38, 39, 40, 41, 42, 43, 44, 45, 46 10 Print Code: I(8)

New



Telarox 21112

Trainers. Canvas/TPR.
Sneaker. Canvas/TPR.
Baskets. Canvas/TPR.
Sportschoenen. Canvas/TPR.

36, 37, 38, 39, 40, 41, 42, 43, 44, 45, 46 10 Print Code: I(8)

Cotton touch

New



Hearvin 21160 160 GSM

Adult T-Shirt. 100% Polyester 160 g/ m2. Cotton Touch. Breathable.
 Erwachsene T-Shirt. 100% Polyester 160 g/ m2. Cotton Touch. Atmungsaktiv.
 T-Shirt Adulte. 100% Polyester 160 g/ m2. Cotton Touch. Respirant.
 T-Shirt Volwassene. 100% Polyester 160 g/ m2. Cotton Touch. Ademend.

Print Code: F(6), N(8), O, P

New



New



Hearvin 21162 160 GSM

Kids T-Shirt. 100% Polyester 160 g/ m2. Cotton Touch. Breathable.
 Kinder T-Shirt. 100% Polyester 160 g/ m2. Cotton Touch. Atmungsaktiv.
 T-Shirt Enfant. 100% Polyester 160 g/ m2. Cotton Touch. Respirant.
 Kinder T-Shirt. 100% Polyester 160 g/ m2. Cotton Touch. Ademend.

Print Code: F(6), N(8), O, P



UNISEX



BREATHABLE



CREASE FREE

REMOVABLE
PRINT

Hearvin 21161 160 GSM

Women T-Shirt. 100% Polyester 160 g/ m2. Cotton Touch. Breathable.
 Frauen T-Shirt. 100% Polyester 160 g/ m2. Cotton Touch. Atmungsaktiv.
 T-Shirt Femme. 100% Polyester 160 g/ m2. Cotton Touch. Respirant.
 Dames T-Shirt. 100% Polyester 160 g/ m2. Cotton Touch. Ademend.

Print Code: F(6), N(8), O, P





Helixa 8002 150 GSM



Adult T-Shirt. 100% Cotton Ring Spun, Single Jersey 150 g/ m2.
 Erwachsene T-Shirt. 100% Baumwolle Ring Spun, Single Jersey 150 g/ m2.
 T-Shirt Adulte. 100% Coton Ring Spun, Single Jersey 150 g/ m2.
 T-Shirt Volwassene. 100% Katoen Ring Spun, Single Jersey 150 g/ m2.

XS, S, M, L, XL, XXL 100 / 5 Print Code: F(6), N(8), O, P



Sunt 8000 150 GSM



Adult T-Shirt. 100% Cotton Ring Spun, Single Jersey 150 g/ m2.
 Erwachsene T-Shirt. 100% Baumwolle Ring Spun, Single Jersey 150 g/ m2.
 T-Shirt Adulte. 100% Coton Ring Spun, Single Jersey 150 g/ m2.
 T-Shirt Volwassene. 100% Katoen Ring Spun, Single Jersey 150 g/ m2.

XS, S, M, L, XL, XXL 100 / 5 Print Code: F(6), N(8), O, P



Vega 8001 150 GSM



REMOVABLE LABEL



UNISEX

Adult T-Shirt. 100% Cotton Ring Spun, Single Jersey 150 g/ m2.
 Erwachsene T-Shirt. 100% Baumwolle Ring Spun, Single Jersey 150 g/ m2.
 T-Shirt Adulte. 100% Coton Ring Spun, Single Jersey 150 g/ m2.
 T-Shirt Volwassene. 100% Katoen Ring Spun, Single Jersey 150 g/ m2.

XS, S, M, L, XL, XXL 100 / 5 Print Code: F(6), N(8), O, P



227

006

018

660

663

Nimo 8005 150 GSM



REMOVABLE LABEL



UNISEX

Adult T-Shirt. 100% Cotton Ring Spun, Single Jersey 150 g/ m2.
 Erwachsene T-Shirt. 100% Baumwolle Ring Spun, Single Jersey 150 g/ m2.
 T-Shirt Adulte. 100% Coton Ring Spun, Single Jersey 150 g/ m2.
 T-Shirt Volwassene. 100% Katoen Ring Spun, Single Jersey 150 g/ m2.

XS, S, M, L, XL, XXL 100 / 5 Print Code: F(6), N(8), O, P

1090

makito



New

Seiyo 21141



New

Seiyo 21179



Seiyo 21141 160 GSM

Women Colour T-Shirt. 100% Ring Spun Cotton, Single Jersey 160 g/ m2.
 Erwachsene Frauen Farbe T-Shirt. 100% Ring Spun Baumwolle, Single Jersey 160 g/ m2.
 T-Shirt Femme Couleur. 100% Coton Ring Spun, Single Jersey 160 g/ m2.
 Dames Kleuren T-Shirt. 100% Ring Spun Katoen, Single Jersey 160 g/ m2.

Print Code: F(6), N(8), O, P

Seiyo 21179 160 GSM

Women White T-Shirt. 100% Ring Spun Cotton, Single Jersey 160 g/ m2.
 Erwachsene Frauen Weiß T-Shirt. 100% Ring Spun Baumwolle, Single Jersey 160 g/ m2.
 T-Shirt Femme Blanc. 100% Coton Ring Spun, Single Jersey 160 g/ m2.
 Wit Dames T-Shirt. 100% Ring Spun Katoen, Single Jersey 160 g/ m2.

Print Code: F(6), M, N(8), O, P



New

Seiyo 21142



New

Seiyo 21180



Seiyo 21142 160 GSM

Kids Colour T-Shirt. 100% Ring Spun Cotton, Single Jersey 160 g/ m2.
 Kinder Farbe T-Shirt. 100% Ring Spun Baumwolle, Single Jersey 160 g/ m2.
 T-Shirt Enfant Couleur. 100% Coton Ring Spun, Single Jersey 160 g/ m2.
 Kleuren Kinder T-Shirt. 100% Ring Spun Katoen, Single Jersey 160 g/ m2.

Print Code: F(6), N(8), O, P



UNISEX



UNISEX

Seiyo 21180 160 GSM

Kids White T-Shirt. 100% Ring Spun Cotton, Single Jersey 160 g/ m2.
 Kinder Weiß T-Shirt. 100% Ring Spun Baumwolle, Single Jersey 160 g/ m2.
 T-Shirt Enfant Blanc. 100% Coton Ring Spun, Single Jersey 160 g/ m2.
 Wit Kinder T-Shirt. 100% Ring Spun Katoen, Single Jersey 160 g/ m2.

Print Code: F(6), M, N(8), O, P



100%
Cotton
160GSM

1091

makito

New

New



Seiyo 21178 160 GSM

Adult White T-Shirt. 100% Ring Spun Cotton, Single Jersey 160 g/ m2.
Erwachsene Weiß T-Shirt. 100% Ring Spun Baumwolle, Single Jersey 160 g/ m2.
T-Shirt Adulte Blanc. 100% Coton Ring Spun, Single Jersey 160 g/ m2.
Wit T-Shirt Volwassene. 100% Ring Spun Katoen, Single Jersey 160 g/ m2.

S, M, L, XL, XXL, 3XL 100 Print Code: F(6), M, N(8), O, P

Seiyo 21140 160 GSM

Adult Colour T-Shirt. 100% Ring Spun Cotton, Single Jersey 160 g/ m2.
Erwachsene Farbe T-Shirt. 100% Ring Spun Baumwolle, Single Jersey 160 g/ m2.
T-Shirt Adulte Couleur. 100% Coton Ring Spun, Single Jersey 160 g/ m2.
Kleuren T-Shirt Volwassene. 100% Ring Spun Katoen, Single Jersey 160 g/ m2.

S, M, L, XL, XXL, 3XL 100 Print Code: F(6), N(8), O, P

1092

Keya



WCS150 5868



WCS150 5867



WCS150 5868 150 GSM

Women Colour T-Shirt "keya". 100% Cotton Ring Spun, Single Jersey 150 g/ m2.
 Frauen Farbe T-Shirt "keya". 100% Baumwolle Ring Spun, Single Jersey 150 g/ m2.
 T-Shirt Femme Couleur "keya". 100% Coton Ring Spun, Single Jersey 150 g/ m2.
 Kleuren Dames T-Shirt "keya". 100% Katoen Ring Spun, Single Jersey 150 g/ m2.

☑️ S, M, L, XL, XXL 📦 100 🗣️ Print Code: F(6), N(8), O, P

WCS150 5867 150 GSM

Women White T-Shirt "keya". 100% Cotton Ring Spun, Single Jersey 150 g/ m2.
 Frauen Weiß T-Shirt "keya". 100% Baumwolle Ring Spun, Single Jersey 150 g/ m2.
 T-Shirt Femme Blanc "keya". 100% Coton Ring Spun, Single Jersey 150 g/ m2.
 Wit Dames T-Shirt "keya". 100% Katoen Ring Spun, Single Jersey 150 g/ m2.

☑️ S, M, L, XL, XXL 📦 100 🗣️ Print Code: F(6), N(8), M, O, P



YC150 5874



YC150 5873



YC150 5874 150 GSM



UNISEX

Kids Colour T-Shirt "keya". 100% Cotton Ring Spun, Single Jersey 150 g/ m2.
 Kinder Farbe T-Shirt "keya". 100% Baumwolle Ring Spun, Single Jersey 150 g/ m2.
 T-Shirt Enfant Couleur "keya". 100% Coton Ring Spun, Single Jersey 150 g/ m2.
 Kleuren Kinder T-Shirt "keya". 100% Katoen Ring Spun, Single Jersey 150 g/ m2.

☑️ XS (5-6), S (7-8), M (10-11), L (12-13), XL (14-15) 📦 100
 🗣️ Print Code: F(6), N(8), O, P

YC150 5873 150 GSM



UNISEX

Kids White T-Shirt "keya". 100% Cotton Ring Spun, Single Jersey 150 g/ m2.
 Kinder Weiß T-Shirt "keya". 100% Baumwolle Ring Spun, Single Jersey 150 g/ m2.
 T-Shirt Enfant Blanc "keya". 100% Coton Ring Spun, Single Jersey 150 g/ m2.
 Wit Kinder T-Shirt "keya". 100% Katoen Ring Spun, Single Jersey 150 g/ m2.

☑️ XS (5-6), S (7-8), M (10-11), L (12-13), XL (14-15) 📦 100
 🗣️ Print Code: F(6), N(8), M, O, P

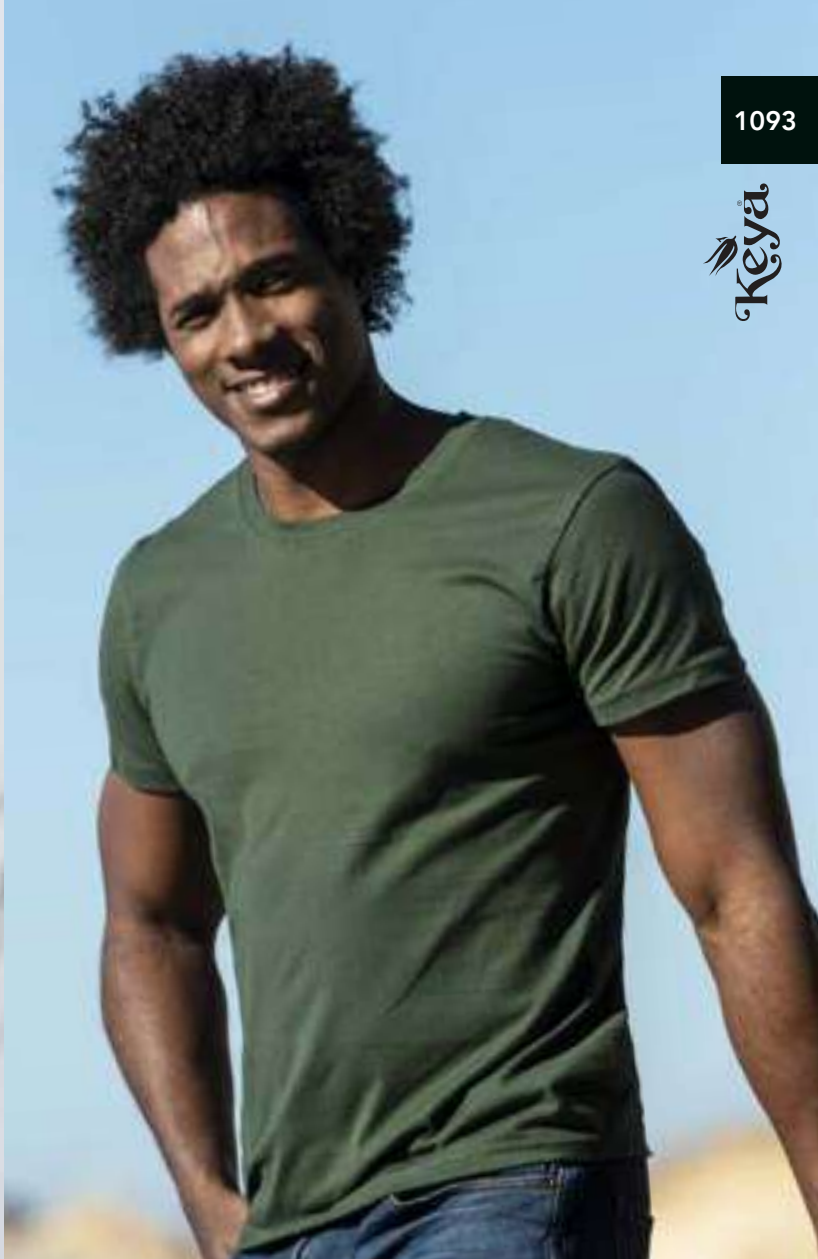

MC150 5856 150 GSM

Adult White T-Shirt "keya". 100% Cotton Ring Spun, Single Jersey 150 g/ m2.
 Erwachsene Weiß T-Shirt "keya". 100% Baumwolle Ring Spun, Single Jersey 150 g/ m2.
 T-Shirt Adulte Blanc "keya". 100% Coton Ring Spun, Single Jersey 150 g/ m2.
 Volwassene Wit T-Shirt "keya". 100% Katoen Ring Spun, Single Jersey 150 g/ m2.

Print Code: F(6), N(8), M, O, P

MC150 5857 150 GSM

Adult Colour T-Shirt "keya". 100% Cotton Ring Spun, Single Jersey 150 g/ m2.
 Erwachsene Farbe T-Shirt "keya". 100% Baumwolle Ring Spun, Single Jersey 150 g/ m2.
 T-Shirt Adulte Couleur "keya". 100% Coton Ring Spun, Single Jersey 150 g/ m2.
 Volwassene Kleuren T-Shirt "keya". 100% Katoen Ring Spun, Single Jersey 150 g/ m2.

Print Code: F(6), N(8), O, P

1094

Keya



MC130 5854 130 GSM

Adult White T-Shirt "keya". 100% Cotton Ring Spun, Single Jersey 130 g/ m2.
 Erwachsene Weiß T-Shirt "keya". 100% Baumwolle Ring Spun, Single Jersey 130 g/ m2.
 T-Shirt Adulte Blanc "keya". 100% Coton Ring Spun, Single Jersey 130 g/ m2.
 Volwassen Wit T-Shirt "keya". 100% Katoen Ring Spun, Single Jersey 130 g/ m2.

☞ S, M, L, XL, XXL ☞ 100 ☞ Print Code: F(6), N(6), M, O, P

MC130 5855 130 GSM

Adult Colour T-Shirt "keya". 100% Cotton Ring Spun, Single Jersey 130 g/ m2.
 Erwachsene Farbe T-Shirt "keya". 100% Baumwolle Ring Spun, Single Jersey 130 g/ m2.
 T-Shirt Adulte Couleur "keya". 100% Coton Ring Spun, Single Jersey 130 g/ m2.
 Volwassen Kleuren T-Shirt "keya". 100% Katoen Ring Spun, Single Jersey 130 g/ m2.

☞ S, M, L, XL, XXL ☞ 100 ☞ Print Code: F(6), N(6), O, P

Heavy Cotton

1095

Keya



MC180-OE 5860 180 GSM

Adult White T-Shirt "keya". 100% Heavy Cotton Ring Spun, Single Jersey 180 g/ m2.
Erwachsene Weiß T-Shirt "keya". 100% Dickes Baumwolle Ring Spun, Single Jersey 180 g/ m2.
T-Shirt Adulte Blanc "keya". 100% Coton Épais Ring Spun, Single Jersey 180 g/ m2.
Volwassene Wit T-Shirt "keya". 100% Dikke Katoen Ring Spun, Single Jersey 180 g/ m2.

☐ S, M, L, XL, XXL, 3XL 📦 100 🗉 Print Code: F(6), N(8), M, O, P

MC180-OE 5861 180 GSM

Adult Colour T-Shirt "keya". 100% Heavy Cotton Ring Spun, Single Jersey 180 g/ m2.
Erwachsene Farbe T-Shirt "keya". 100% Dickes Baumwolle Ring Spun, Single Jersey 180 g/ m2.
T-Shirt Adulte Couleur "keya". 100% Coton Épais Ring Spun, Single Jersey 180 g/ m2.
Volwassene Kleuren T-Shirt "keya". 100% Dikke Katoen Ring Spun, Single Jersey 180 g/ m2.

☐ S, M, L, XL, XXL, 3XL 📦 100 🗉 Print Code: F(6), N(8), O, P

1096

Keya



WCS180 5869 180 GSM

Women White T-Shirt "keya". 100% Cotton Ring Spun, Single Jersey 180 g/ m2.
 Frauen Weiß T-Shirt "keya". 100% Baumwolle Ring Spun, Single Jersey 180 g/ m2.
 T-Shirt Femme Blanc "keya". 100% Coton Ring Spun, Single Jersey 180 g/ m2.
 Wit Dames T-Shirt "keya". 100% Katoen Ring Spun, Single Jersey 180 g/ m2.

☞ S, M, L, XL, XXL ☞ 100 ☞ Print Code: F(6), N(6), M, O, P

WCS180 5870 180 GSM

Women Colour T-Shirt "keya". 100% Cotton Ring Spun, Single Jersey 180 g/ m2.
 Frauen Farbe T-Shirt "keya". 100% Baumwolle Ring Spun, Single Jersey 180 g/ m2.
 T-Shirt Femme Couleur "keya". 100% Coton Ring Spun, Single Jersey 180 g/ m2.
 Kleuren Dames T-Shirt "keya". 100% Katoen Ring Spun, Single Jersey 180 g/ m2.

☞ S, M, L, XL, XXL ☞ 100 ☞ Print Code: F(6), N(6), O, P



MC180 5858 180 GSM

Adult White T-Shirt "keya". 100% Cotton Ring Spun, Single Jersey 180 g/ m2.
 Erwachsene Weiß T-Shirt "keya". 100% Baumwolle Ring Spun, Single Jersey 180 g/ m2.
 T-Shirt Adulte Blanc "keya". 100% Coton Ring Spun, Single Jersey 180 g/ m2.
 Volwassene Wit T-Shirt "keya". 100% Katoen Ring Spun, Single Jersey 180 g/ m2.

☐ S, M, L, XL, XXL, 3XL 📦 100 🏷️ Print Code: F(6), N(8), M, O, P

MC180 5859 180 GSM

Adult Colour T-Shirt "keya". 100% Cotton Ring Spun, Single Jersey 180 g/ m2.
 Erwachsene Farbe T-Shirt "keya". 100% Baumwolle Ring Spun, Single Jersey 180 g/ m2.
 T-Shirt Adulte Couleur "keya". 100% Coton Ring Spun, Single Jersey 180 g/ m2.
 Volwassene Kleuren T-Shirt "keya". 100% Katoen Ring Spun, Single Jersey 180 g/ m2.

☐ S, M, L, XL, XXL, 3XL 📦 100 🏷️ Print Code: F(6), N(8), O, P



Guim 8006

150 GSM



Adult T-Shirt. 100% Organic Cotton Ring Spun, Single Jersey 150 g/ m2.
 Erwachsene T-Shirt. 100% Organische Baumwolle Ring Spun, Single Jersey 150 g/ m2.
 T-Shirt Adulte. 100% Coton Organique Ring Spun, Single Jersey 150 g/ m2.
 T-Shirt Volwassene. 100% Organisch Katoen Ring Spun, Single Jersey 150 g/ m2.

XS, S, M, L, XL, XXL 100 / 10 Print Code: F(6), N(8), O, P



Organic Color 6760

150 GSM



Adult T-Shirt "keya". 100% Organic Cotton Ring Spun, Single Jersey 150 g/ m2.
 Erwachsene T-Shirt "keya". 100% Organische Baumwolle Ring Spun, Single Jersey 150 g/ m2.
 T-Shirt Adulte "keya". 100% Coton Organique Ring Spun, Single Jersey 150 g/ m2.
 T-Shirt Volwassene "keya". 100% Organisch Katoen Ring Spun, Single Jersey 150 g/ m2.

S, M, L, XL, XXL 100 Print Code: F(6), N(8), O, P



RECYCLED
COTTON
& RPET

1099

makito

New



Bandul 21138

New



Bandul 21137

Bandul 21138

150 GSM



Women T-Shirt. 60% Recycled Cotton Single Jersey/ 40% Polyester RPET 150 g/ m2.
Frauen T-Shirt. 60% Recycling Baumwolle Single Jersey/ 40% Polyester RPET 150 g/ m2.
T-Shirt Femme. 60% Coton Recyclé Single Jersey/ 40% Polyester RPET 150 g/ m2.
Dames T-Shirt. 60% Gerecycled Katoen Single Jersey/ 40% Polyester RPET 150 g/ m2.

Print Code: F(6), N(8), O, P



Bandul 21137

150 GSM



Adult T-Shirt. 60% Recycled Cotton Single Jersey/ 40% Polyester RPET 150 g/ m2.
Erwachsene T-Shirt. 60% Recycling Baumwolle Single Jersey/ 40% Polyester RPET 150 g/ m2.
T-Shirt Adulte. 60% Coton Recyclé Single Jersey/ 40% Polyester RPET 150 g/ m2.
T-Shirt Volwassenene. 60% Gerecycled Katoen Single Jersey/ 40% Polyester RPET 150 g/ m2.

Print Code: F(6), N(8), O, P



Bandul 21139

150 GSM



Kids T-Shirt. 60% Recycled Cotton Single Jersey/ 40% Polyester RPET 150 g/ m2.
Kinder T-Shirt. 60% Recycling Baumwolle Single Jersey/ 40% Polyester RPET 150 g/ m2.
T-Shirt Enfant. 60% Coton Recyclé Single Jersey/ 40% Polyester RPET 150 g/ m2.
Kinder T-Shirt. 60% Gerecycled Katoen Single Jersey/ 40% Polyester RPET 150 g/ m2.

Print Code: F(6), N(8), O, P



New



Bandul 21139

1100

Keya

Organic
Cotton

Organic MN 6630 150 GSM

Adult T-Shirt "keya". 100% Organic Cotton Ring Spun, Single Jersey 150 g/ m².
 Erwachsene T-Shirt "keya". 100% Organische Baumwolle Ring Spun, Single Jersey 150 g/ m².
 T-Shirt Adulte "keya". 100% Coton Organique Ring Spun, Single Jersey 150 g/ m².
 T-Shirt Volwassene "keya". 100% Organisch Katoen Ring Spun, Single Jersey 150 g/ m².

Print Code: F(6), N(8), O, P



Organic WM 1298 150 GSM

Women T-Shirt "keya". 100% Organic Cotton Ring Spun, Single Jersey 150 g/ m².
 Frauen T-Shirt "keya". 100% Organische Baumwolle Ring Spun, Single Jersey 150 g/ m².
 T-Shirt Femme "keya". 100% Coton Organique Ring Spun, Single Jersey 150 g/ m².
 Dames T-Shirt "keya". 100% Organisch Katoen Ring Spun, Single Jersey 150 g/ m².

Print Code: F(6), N(8), O, P



Organic KD 1299 150 GSM

Kids T-Shirt "keya". 100% Organic Cotton Ring Spun, Single Jersey 150 g/ m².
 Kinder T-Shirt "keya". 100% Organische Baumwolle Ring Spun, Single Jersey 150 g/ m².
 T-Shirt Enfant "keya". 100% Coton Organique Ring Spun, Single Jersey 150 g/ m².
 Kinder T-Shirt "keya". 100% Organisch Katoen Ring Spun, Single Jersey 150 g/ m².

Print Code: F(6), N(8), O, P



REMOVABLE LABEL



UNISEX

Sury 8003 150 GSM

Adult T-Shirt. 100% Cotton Ring Spun, Single Jersey 150 g/ m2.

Erwachsene T-Shirt. 100% Baumwolle Ring Spun, Single Jersey 150 g/ m2.

T-Shirt Adulte. 100% Coton Ring Spun, Single Jersey 150 g/ m2.

T-Shirt Volwassene. 100% Katoen Ring Spun, Single Jersey 150 g/ m2.

XS, S, M, L, XL, XXL

100 / 5

Print Code: F(6), N(8), O, P



008



227



660



006



Krusly 5250 140 GSM

Adult T-Shirt. 100% Polyester 140 g/ m2. Cotton Touch. Breathable.
Erwachsene T-Shirt. 100% Polyester 140 g/ m2. Cotton Touch. Atmungsaktiv.
T-Shirt Adulte. 100% Polyester 140 g/ m2. Cotton Touch. Respirant.
T-Shirt Volwassene. 100% Polyester 140 g/ m2. Cotton Touch. Ademend.

📏 S, M, L, XL, XXL 📦 80 / 10 🏷️ Print Code: F(6), N(6), M, O, P, R

Krusly 5251 140 GSM

Kids T-Shirt. 100% Polyester 140 g/ m2. Cotton Touch. Breathable.
Kinder T-Shirt. 100% Polyester 140 g/ m2. Cotton Touch. Atmungsaktiv.
T-Shirt Enfant. 100% Polyester 140 g/ m2. Cotton Touch. Respirant.
Kinder T-Shirt. 100% Polyester 140 g/ m2. Cotton Touch. Ademend.

📏 4-5, 6-8, 10-12 📦 100 / 10 🏷️ Print Code: F(6), N(6), M, O, P, R



Original T 1332 140 GSM

Adult White T-Shirt. 100% Cotton 140 g/ m2.
 Erwachsene Weiß T-Shirt. 100% Baumwolle 140 g/ m2.
 T-Shirt Adulte Blanc. 100% Coton 140 g/ m2.
 Wit T-Shirt Volwassene. 100% Katoen 140 g/ m2.

S, M, L, XL,
 120
 Print Code: F(6), M, N(8), O, P
 XXL
 108

Original T 1333 145 GSM

Adult Colour T-Shirt. 100% Cotton 145 g/ m2.
 Erwachsene Farbe T-Shirt. 100% Baumwolle 145 g/ m2.
 T-Shirt Adulte Couleur. 100% Coton 145 g/ m2.
 Kleuren T-Shirt Volwassene. 100% Katoen 145 g/ m2.

S, M, L, XL,
 120
 Print Code: F(6), M, N(8), O, P
 XXL
 108



FRUIT OF THE LOOM
ICONIC



Iconic 1316 140 GSM

Adult White T-Shirt. 100% Combed Cotton Ring Spun 140 g/ m2.
Erwachsene Weiß T-Shirt. 100% Gekämmte Baumwolle Ring Spun 140 g/ m2.
T-Shirt Adulte Blanc. 100% Coton Peigné Ring Spun 140 g/ m2.
Wit T-Shirt Volwassene. 100% Gekamd Katoen Ring Spun 140 g/ m2.

 S, M, L, XL, XXL  72  Print Code: F(6), M, N(8), O, P

Iconic 1317 140 GSM

Women White T-Shirt. 100% Combed Cotton Ring Spun 140 g/ m2.
Frauen Weiß T-Shirt. 100% Gekämmte Baumwolle Ring Spun 140 g/ m2.
T-Shirt Femme Blanc. 100% Coton Peigné Ring Spun 140 g/ m2.
Wit Dames T-Shirt. 100% Gekamd Katoen Ring Spun 140 g/ m2.

 XS, S, M, L, XL, XXL  72  Print Code: F(6), M, N(8), O, P



Iconic 1324 150 GSM

Adult Colour T-Shirt. 100% Combed Cotton Ring Spun 150 g/ m2.
Erwachsene Farbe T-Shirt. 100% Gekämmte Baumwolle Ring Spun 150 g/ m2.
T-Shirt Adulte Couleur. 100% Coton Peigné Ring Spun 150 g/ m2.
Kleuren T-Shirt Volwassene. 100% Gekamd Katoen Ring Spun 150 g/ m2.

 S, M, L, XL, XXL  72  Print Code: F(6), N(8), O, P



Iconic 1325 150 GSM

Women Colour T-Shirt. 100% Combed Cotton Ring Spun 150 g/ m2.
Frauen Farbe T-Shirt. 100% Gekämmte Baumwolle Ring Spun 150 g/ m2.
T-Shirt Femme Couleur. 100% Coton Peigné Ring Spun 150 g/ m2.
Kleuren Dames T-Shirt. 100% Gekamd Katoen Ring Spun 150 g/ m2.

 XS, S, M, L, XL, XXL  72  Print Code: F(6), N(8), O, P



Iconic 1329 150 GSM

Kids Colour T-Shirt. 100% Combed Cotton Ring Spun 150 g/ m2.
 Kinder Farbe T-Shirt. 100% Gekämmte Baumwolle Ring Spun 150 g/ m2.
 T-Shirt Enfant Couleur. 100% Coton Peigné Ring Spun 150 g/ m2.
 Kleuren Kinder T-Shirt. 100% Gekamd Katoen Ring Spun 150 g/ m2.

Print Code: F(6), M, N(8), O, P



Iconic 1328 150 GSM

Kids Colour T-Shirt. 100% Combed Cotton Ring Spun 150 g/ m2.
 Kinder Farbe T-Shirt. 100% Gekämmte Baumwolle Ring Spun 150 g/ m2.
 T-Shirt Enfant Couleur. 100% Coton Peigné Ring Spun 150 g/ m2.
 Kleuren Kinder T-Shirt. 100% Gekamd Katoen Ring Spun 150 g/ m2.

Print Code: F(6), M, N(8), O, P

Iconic 1321 140 GSM

Kids White T-Shirt. 100% Combed Cotton Ring Spun 140 g/ m2.
 Kinder Weiß T-Shirt. 100% Gekämmte Baumwolle Ring Spun 140 g/ m2.
 T-Shirt Enfant Blanc. 100% Coton Peigné Ring Spun 140 g/ m2.
 Wit Kinder T-Shirt. 100% Gekamd Katoen Ring Spun 140 g/ m2.

Print Code: F(6), M, N(8), O, P

Iconic 1320 140 GSM

Kids White T-Shirt. 100% Combed Cotton Ring Spun 140 g/ m2.
 Kinder Weiß T-Shirt. 100% Gekämmte Baumwolle Ring Spun 140 g/ m2.
 T-Shirt Enfant Blanc. 100% Coton Peigné Ring Spun 140 g/ m2.
 Wit Kinder T-Shirt. 100% Gekamd Katoen Ring Spun 140 g/ m2.

Print Code: F(6), M, N(8), O, P





FRUIT & LOOM.
ICONIC



Iconic V-Neck 1326 150 GSM

Adult Colour T-Shirt. 100% Combed Cotton Ring Spun 150 g/ m2.
 Erwachsene Farbe T-Shirt. 100% Gekämmte Baumwolle Ring Spun 150 g/ m2.
 T-Shirt Adulte Couleur. 100% Coton Peigné Ring Spun 150 g/ m2.
 Kleuren T-Shirt Volwassene. 100% Gekamd Katoen Ring Spun 150 g/ m2.

 S, M, L, XL, XXL  72  Print Code: F(6), N(8), O, P



Iconic V-Neck 1327 150 GSM

Women Colour T-Shirt. 100% Combed Cotton Ring Spun 150 g/ m2.
 Frauen Farbe T-Shirt. 100% Gekämmte Baumwolle Ring Spun 150 g/ m2.
 T-Shirt Femme Couleur. 100% Coton Peigné Ring Spun 150 g/ m2.
 Kleuren Dames T-Shirt. 100% Gekamd Katoen Ring Spun 150 g/ m2.

 XS, S, M, L, XL, XXL  72  Print Code: F(6), N(8), O, P



Iconic V-Neck 1318 140 GSM

Adult White T-Shirt. 100% Combed Cotton Ring Spun 140 g/ m2.
 Erwachsene Weiß T-Shirt. 100% Gekämmte Baumwolle Ring Spun 140 g/ m2.
 T-Shirt Adulte Blanc. 100% Coton Peigné Ring Spun 140 g/ m2.
 Wit T-Shirt Volwassene. 100% Gekamd Katoen Ring Spun 140 g/ m2.

 S, M, L, XL, XXL  72  Print Code: F(6), M, N(8), O, P

Iconic V-Neck 1319 140 GSM

Women White T-Shirt. 100% Combed Cotton Ring Spun 140 g/ m2.
 Frauen Weiß T-Shirt. 100% Gekämmte Baumwolle Ring Spun 140 g/ m2.
 T-Shirt Femme Blanc. 100% Coton Peigné Ring Spun 140 g/ m2.
 Wit Dames T-Shirt. 100% Gekamd Katoen Ring Spun 140 g/ m2.

 XS, S, M, L, XL, XXL  72  Print Code: F(6), M, N(8), O, P

Cotton Pique Fabric

1107



FRUIT OF THE LOOM.
ORIGINAL



Original 1323 175 GSM

Adult White Polo Shirt. 100% Cotton Pique 175 g/ m2.
Erwachsene Weiß Polo-Shirt. 100% Baumwolle Pique 175 g/ m2.
Polo Adulte Blanc. 100% Coton Pique 175 g/ m2.
Volwassene Wit Polo Shirt. 100% Katoen Pique 175 g/ m2.

S, M, L, XL, XXL 36 Print Code: F(6), N(6), O, P

Original 1331 185 GSM

Adult Colour Polo Shirt. 100% Cotton Pique 185 g/ m2.
Erwachsene Farbe Polo-Shirt. 100% Baumwolle Pique 185 g/ m2.
Polo Adulte Couleur. 100% Coton Pique 185 g/ m2.
Volwassene Kleuren T-Shirt. 100% Katoen Pique 185 g/ m2.

S, M, L, XL, XXL 36 Print Code: F(6), N(6), O, P

Polyester
Pique Fabric



08

05

01

Tecnic Rebon 21153 180 GSM

Polo Shirt. 100% Polyester, Pique 180 g/ m2. Breathable.
 Polo-Shirt. 100% Polyester, Pique 180 g/ m2. Atmungsaktiv.
 Polo. 100% Polyester, Pique 180 g/ m2. Respirant.
 Polo Shirt. 100% Polyester, Pique 180 g/ m2. Ademend.

XS, S, M, L, XL, XXL 50 / 10 Print Code: F(6), N(8), O, P



01

02

03

06

08

19

Tecnic Zawak 21145 180 GSM

Polo Shirt. 100% Polyester, Pique 180 g/ m2. Breathable.
 Polo-Shirt. 100% Polyester, Pique 180 g/ m2. Atmungsaktiv.
 Polo. 100% Polyester, Pique 180 g/ m2. Respirant.
 Polo Shirt. 100% Polyester, Pique 180 g/ m2. Ademend.

XS, S, M, L, XL, XXL 50 / 10 Print Code: F(6), N(8), O, P, R

**Polyester
Pique Fabric**

**Polyester
Mesh Fabric**

1109

makito

New



02 03 01 05 06 07 08 11 19 21 04



Tecnic Plus 4187 180 GSM

Polo Shirt. 100% Polyester, Pique 180 g/ m2. Breathable.
 Polo-Shirt. 100% Polyester, Pique 180 g/ m2. Atmungsaktiv.
 Polo. 100% Polyester, Pique 180 g/ m2. Respirant.
 Polo Shirt. 100% Polyester, Pique 180 g/ m2. Ademend.

Print Code: F(6), N(8), O, P, R



01 02 03 06 08 19



Tecnic Ratlam 21154 160 GSM

Polo Shirt. 100% Polyester 160 g/ m2. Breathable.
 Polo-Shirt. 100% Polyester 160 g/ m2. Atmungsaktiv.
 Polo. 100% Polyester 160 g/ m2. Respirant.
 Polo Shirt. 100% Polyester 160 g/ m2. Ademend.

Print Code: F(6), N(8), O, P, R

1110

makito

Cotton

Pique Fabric
220 GSM

New



New



Koupan 21144 220 GSM

Women Colour Polo Shirt. 100% Ring Spun Cotton, Pique 220 g/ m2.
Erwachsene Frauen Farbe Polo-Shirt. 100% Ring Spun Baumwolle, Pique 220 g/ m2.
Polo Femme Couleur. 100% Coton Ring Spun, Pique 220 g/ m2.
Dames Kleuren Polo Shirt. 100% Ring Spun Katoen, Pique 220 g/ m2.

☞ S, M, L, XL, XXL ☞ 50 ☞ Print Code: F(6), N(8), O, P

Koupan 21182 220 GSM

Women White Polo Shirt. 100% Ring Spun Cotton, Pique 220 g/ m2.
Erwachsene Frauen Weiß Polo-Shirt. 100% Ring Spun Baumwolle, Pique 220 g/ m2.
Polo Femme Blanc. 100% Coton Ring Spun, Pique 220 g/ m2.
Dames Wit Polo Shirt. 100% Ring Spun Katoen, Pique 220 g/ m2.

☞ S, M, L, XL, XXL ☞ 50 ☞ Print Code: F(6), N(8), O, P

Cotton
Pique Fabric
220 GSM

1111

makito

New



New



Koupan 21181 220 GSM

Adult White Polo Shirt. 100% Ring Spun Cotton, Pique 220 g/ m2.
Erwachsene Weiß Polo-Shirt. 100% Ring Spun Baumwolle, Pique 220 g/ m2.
Polo Adulte Blanc. 100% Coton Ring Spun, Pique 220 g/ m2.
Volwassene Wit T-Shirt. 100% Ring Spun Katoen, Pique 220 g/ m2.

☐ S, M, L, XL, XXL, 3XL 📄 50 🗉 Print Code: F(6), N(8), O, P

Koupan 21143 220 GSM

Adult Colour Polo Shirt. 100% Ring Spun Cotton, Pique 220 g/ m2.
Erwachsene Farbe Polo-Shirt. 100% Ring Spun Baumwolle, Pique 220 g/ m2.
Polo Adulte Couleur. 100% Coton Ring Spun, Pique 220 g/ m2.
Volwassene Kleuren T-Shirt. 100% Ring Spun Katoen, Pique 220 g/ m2.

☐ S, M, L, XL, XXL, 3XL 📄 50 🗉 Print Code: F(6), N(8), O, P

1112

Cotton Pique Fabric



WPS180 5872 180 GSM

Women Colour Polo Shirt "keya". 100% Ring Spun Cotton, Pique 180 g/ m2.
 Frauen Farbe Polo-Shirt "keya". 100% Ring Spun Baumwolle, Pique 180 g/ m2.
 Polo Femme Couleur "keya". 100% Coton Ring Spun, Pique 180 g/ m2.
 Dames Kleuren Polo Shirt "keya". 100% Ring Spun Katoen, Pique 180 g/ m2.

☒ S, M, L, XL, XXL ☒ 50 ☒ Print Code: F(6), N(8), O, P

WPS180 5871 180 GSM

Women White Polo Shirt "keya". 100% Ring Spun Cotton, Pique 180 g/ m2.
 Frauen Weiß Polo-Shirt "keya". 100% Ring Spun Baumwolle, Pique 180 g/ m2.
 Polo Femme Blanc "keya". 100% Coton Ring Spun, Pique 180 g/ m2.
 Dames Wit Polo Shirt "keya". 100% Ring Spun Katoen, Pique 180 g/ m2.

☒ S, M, L, XL, XXL ☒ 50 ☒ Print Code: F(6), N(8), O, P



YPS180 5876 180 GSM

Kids Colour Polo Shirt "keya". 100% Ring Spun Cotton, Pique 180 g/ m2.
 Kinder Farbe Polo-Shirt "keya". 100% Ring Spun Baumwolle, Pique 180 g/ m2.
 Polo Enfant Couleur "keya". 100% Coton Ring Spun, Pique 180 g/ m2.
 Kinder Kleuren T-Shirt "keya". 100% Ring Spun Katoen, Pique 180 g/ m2.

☒ XS (5-6), S (7-8), M (10-11), L (12-13), XL (14-15) ☒ 50 ☒ Print Code: F(6), N(8), O, P

YPS180 5875 180 GSM

Kids White Polo Shirt "keya". 100% Ring Spun Cotton, Pique 180 g/ m2.
 Kinder Weiß Polo-Shirt "keya". 100% Ring Spun Baumwolle, Pique 180 g/ m2.
 Polo Enfant Blanc "keya". 100% Coton Ring Spun, Pique 180 g/ m2.
 Kinder Wit Polo Shirt "keya". 100% Ring Spun Katoen, Pique 180 g/ m2.

☒ XS (5-6), S (7-8), M (10-11), L (12-13), XL (14-15) ☒ 50 ☒ Print Code: F(6), N(8), O, P

Cotton

Pique Fabric

1113

Keya



MPS180 5862 180 GSM

Adult White Polo Shirt "keya". 100% Ring Spun Cotton, Pique 180 g/ m2.
Erwachsene Weiß Polo-Shirt "keya". 100% Ring Spun Baumwolle, Pique 180 g/ m2.
Polo Adulte Blanc "keya". 100% Coton Ring Spun, Pique 180 g/ m2.
Volwassene Wit Polo Shirt "keya". 100% Ring Spun Katoen, Pique 180 g/ m2.

S, M, L, XL, XXL, 3XL 50 Print Code: F(6), N(8), O, P

MPS180 5863 180 GSM

Adult Colour Polo Shirt "keya". 100% Ring Spun Cotton, Pique 180 g/ m2.
Erwachsene Farbe Polo-Shirt "keya". 100% Ring Spun Baumwolle, Pique 180 g/ m2.
Polo Adulte Couleur "keya". 100% Coton Ring Spun, Pique 180 g/ m2.
Volwassene Kleuren T-Shirt "keya". 100% Ring Spun Katoen, Pique 180 g/ m2.

S, M, L, XL, XXL, 3XL 50 Print Code: F(6), N(8), O, P

Cotton

Pique Fabric



06

08

660

227



REMOVABLE LABEL



UNISEX

Ken 8008

180 GSM

Adult Polo Shirt. 100% Cotton Ring Spun, Pique 180 g/ m2.

Erwachsene Polo-Shirt. 100% Baumwolle Ring Spun, Pique 180 g/ m2.

Polo Adulte. 100% Coton Ring Spun, Pique 180 g/ m2.

Volwassen T-Shirt. 100% Katoen Ring Spun, Pique 180 g/ m2.

XS, S, M, L, XL, XXL 50 / 5 Print Code: F(6), N(8), O, P



13P

05P

16P

17P

21P



ORGANIC COTTON



REMOVABLE LABEL



UNISEX

Ment 8009

180 GSM

Adult Polo Shirt. 100% Organic Cotton Ring Spun, Pique 180 g/ m2.

Erwachsene Polo-Shirt. 100% Organische Baumwolle Ring Spun, Pique 180 g/ m2.

Polo Adulte. 100% Coton Organique Ring Spun, Pique 180 g/ m2.

Volwassen T-Shirt. 100% Organisch Katoen Ring Spun, Pique 180 g/ m2.

XS, S, M, L, XL, XXL 50 / 5 Print Code: F(6), N(8), O, P



RPET

Pique Fabric

1115

makito



013 06 02 08



Troky 8007 150 GSM

Adult Polo Shirt. 100% Polyester RPET, Pique 150 g/ m². Breathable.
 Erwachsene Polo-Shirt. 100% Polyester RPET, Pique 150 g/ m². Atmungsaktiv.
 Polo Adulte. 100% Polyester RPET, Pique 150 g/ m². Respirant.
 Volwassen T-Shirt. 100% Polyester RPET, Pique 150 g/ m². Ademend.

 XS, S, M, L, XL, XXL  50 / 5  Print Code: F(6), N(8), O, P, R



01 02 03 04 06 19



Dekrom 6755 180 GSM

Polo Shirt. 100% Polyester RPET, Pique 180 g/ m². Breathable.
 Polo-Shirt. 100% Polyester RPET, Pique 180 g/ m². Atmungsaktiv.
 Polo. 100% Polyester RPET, Pique 180 g/ m². Respirant.
 Polo Shirt. 100% Polyester RPET, Pique 180 g/ m². Ademend.

 S, M, L, XL, XXL  60  Print Code: F(6), N(8), O, P, R





Tecnic Bardlex 6460 180 GSM

Polo Shirt. 100% Polyester, Pique 180 g/ m2. Breathable.
 Polo-Shirt. 100% Polyester, Pique 180 g/ m2. Atmungsaktiv.
 Polo. 100% Polyester, Pique 180 g/ m2. Respirant.
 Polo Shirt. 100% Polyester, Pique 180 g/ m2. Ademend.

☐ S, M, L, XL, XXL 📦 50 🗉 Print Code: F(6), N(8), O, P



Tecnic Maik 4726 135 GSM

Adult T-Shirt. 100% Polyester 135 g/ m2. Breathable.
 Erwachsene T-Shirt. 100% Polyester 135 g/ m2. Atmungsaktiv.
 T-Shirt Adulte. 100% Polyester 135 g/ m2. Respirant.
 T-Shirt Volwassene. 100% Polyester 135 g/ m2. Ademend.

☐ S, M, L, XL, XXL 📦 60 / 10 🗉 Print Code: F(6), N(8), M, O, P, R



Tecnic Gerox 4472 145 GSM

Shorts. 100% Polyester 145 g/ m2. Breathable.
 Shorts. 100% Polyester 145 g/ m2. Atmungsaktiv.
 Shorts. 100% Polyester 145 g/ m2. Respirant.
 Shorts. 100% Polyester 145 g/ m2. Ademend.

☐ 8-10, 12-14, S, M, L, XL 📦 100 / 10 🗉 Print Code: F(6), N(8), O, P, R



Dyed Garment - JEANS EFFECT



1117

Lightweight & Comfortable makito



227

08

06

660



LIGHTWEIGHT & WARM GARMENT



REMOVABLE LABEL



UNISEX

Grea 8011 280 GSM

Adult Sweatshirt. 100% Cotton 280 g/ m2.
 Erwachsene Sweatshirt. 100% Baumwolle 280 g/ m2.
 Sweat-Shirt Adulte. 100% Coton 280 g/ m2.
 Volwassene Sweatshirt. 100% Katoen 280 g/ m2.

XS, S, M, L, XL, XXL 25 / 5 Print Code: F(6), N(8), O, P



13

08

06

04

02



LIGHTWEIGHT & WARM GARMENT



REMOVABLE LABEL



UNISEX

Landon 20177 175 GSM

Adult Sweatshirt. 35% Cotton/ 65% Polyester 175 g/ m2.
 Erwachsene Sweatshirt. 35% Baumwolle/ 65% Polyester 175 g/ m2.
 Sweat-Shirt Adulte. 35% Coton/ 65% Polyester 175 g/ m2.
 Volwassene Sweatshirt. 35% Katoen/ 65% Polyester 175 g/ m2.

XS, S, M, L, XL, XXL 30 / 5 Print Code: F(6), N(8), O, P



280 GSM

Skon 8010



Adult Sweatshirt, 50% Cotton/ 50% Polyester 280 g/ m2.
 Erwachsene Sweatshirt, 50% Baumwolle/ 50% Polyester 280 g/ m2.
 Sweat-Shirt Adulte, 50% Coton/ 50% Polyester 280 g/ m2.
 Volwassene Sweatshirt, 50% Katoen/ 50% Polyester 280 g/ m2.

XS, S, M, L, XL, XXL 25 / 5 Print Code: F(6), N(8), O, P



280 GSM

SWP280 5865



Adult Hooded Sweatshirt "keya". 50% Cotton/ 50% Polyester 280 g/ m2.
 Erwachsene Sweatshirt mit Kapuze "keya". 50% Baumwolle/ 50% Polyester 280 g/ m2.
 Sweat-Shirt à Capuche Adulte "keya". 50% Coton/ 50% Polyester 280 g/ m2.
 Volwassene Hooded Sweatshirt "keya". 50% Katoen/ 50% Polyester 280 g/ m2.

S, M, L, XL, XXL, 3XL 25 Print Code: F(6), N(8), O, P

Organic cotton & RPET

1119

makito



RPET FABRIC



ORGANIC COTTON



LIGHTWEIGHT & WARM GARMENT



UNISEX

Harnix 1302 280 GSM

Adult Hooded Sweatshirt. 60% Organic Cotton/ 40% Polyester RPET 280 g/ m².
Erwachsene Sweatshirt mit Kapuze. 60% Organische Baumwolle/ 40% Polyester RPET 280 g/ m².
Sweat-Shirt à Capuche Adulte. 60% Coton Organique/ 40% Polyester RPET 280 g/ m².
Volwassenes Hooded Sweatshirt. 60% Organisch Katoen/ 40% Polyester RPET 280 g/ m².

XS, S, M, L, XL, XXL, 3XL 30/5
Print Code: F(6), N(8), O, P



RPET FABRIC



ORGANIC COTTON



LIGHTWEIGHT & WARM GARMENT



UNISEX

Sendex 1301 280 GSM

Adult Sweatshirt. 60% Organic Cotton/ 40% Polyester RPET 280 g/ m².
Erwachsene Sweatshirt. 60% Organische Baumwolle/ 40% Polyester RPET 280 g/ m².
Sweat-Shirt Adulte. 60% Coton Organique/ 40% Polyester RPET 280 g/ m².
Volwassenes Sweatshirt. 60% Organisch Katoen/ 40% Polyester RPET 280 g/ m².

XS, S, M, L, XL, XXL, 3XL 30/5
Print Code: F(6), N(8), O, P





SWC280 5864

280 GSM

Adult Sweatshirt "keya". 50% Cotton/ 50% Polyester 280 g/ m2.
 Erwachsene Sweatshirt "keya". 50% Baumwolle/ 50% Polyester 280 g/ m2.
 Sweat-Shirt Adulte "keya". 50% Coton/ 50% Polyester 280 g/ m2.
 Volwassene Sweatshirt "keya". 50% Katoen/ 50% Polyester 280 g/ m2.

☞ S, M, L, XL, XXL, 3XL ☞ 30 ☞ Print Code: F(6), N(8), O, P



Truyi 8013

280 GSM

Adult Sweatshirt. 100% Cotton 280 g/ m2.
 Erwachsene Sweatshirt. 100% Baumwolle 280 g/ m2.
 Sweat-Shirt Adulte. 100% Coton 280 g/ m2.
 Volwassene Sweatshirt. 100% Katoen 280 g/ m2.

☞ XS, S, M, L, XL, XXL ☞ 25 / 5 ☞ Print Code: F(6), N(8), O, P



Lightweight Sweat 8014 240 GSM

Adult Sweatshirt. 80% Cotton/ 20% Polyester 240 g/ m2.
Erwachsene Sweatshirt. 80% Baumwolle/ 20% Polyester 240 g/ m2.
Sweat-Shirt Adulte. 80% Coton/ 20% Polyester 240 g/ m2.
Volwassenne Sweatshirt. 80% Katoen/ 20% Polyester 240 g/ m2.

Print Code: F(6), N(8), O, P



SWZ280 5866 280 GSM

Adult Hooded + Zipper Sweatshirt "keya". 50% Cotton/ 50% Polyester 280 g/ m2.
Erwachsene Sweatshirt mit Kapuze + Reißverschluss "keya". 50% Baumwolle/ 50% Polyester 280 g/ m2.
Sweat-Shirt à Capuche + Crémallière Adulte "keya". 50% Coton/ 50% Polyester 280 g/ m2.
Volwassenne Hooded + Rits Sweatshirt "keya". 50% Katoen/ 50% Polyester 280 g/ m2.

Print Code: F(6), N(8), O, P



Klusten 4724 265 GSM

Technical Jacket. 100% Polyester 265 g/ m2.
Technische Jacke. 100% Polyester 265 g/ m2.
Veste Technique. 100% Polyester 265 g/ m2.
Technische Jas. 100% Polyester 265 g/ m2.

Print Code: F(6), N(8), M, O, P, R



1122



Lightweight Set-In Sweat 1334

Adult Sweatshirt. 80% Cotton/ 20% Polyester 240 g/ m2.
 Erwachsene Sweatshirt. 80% Baumwolle/ 20% Polyester 240 g/ m2.
 Sweat-Shirt Adulte. 80% Coton/ 20% Polyester 240 g/ m2.
 Volwassene Sweatshirt. 80% Katoen/ 20% Polyester 240 g/ m2.

S, M, L, XL, XXL 24 Print Code: F(6), M, N(8), O, P



240 GSM



Classic Set-In Sweat 1499

Kids Sweatshirt. 80% Cotton/ 20% Polyester 280 g/ m2.
 Kinder Sweatshirt. 80% Baumwolle/ 20% Polyester 280 g/ m2.
 Sweat-Shirt Enfant. 80% Coton/ 20% Polyester 280 g/ m2.
 Kinder Sweatshirt. 80% Katoen/ 20% Polyester 280 g/ m2.

5-6, 7-8, 9-11, 12-13, 14-15 36 Print Code: F(6), N(8), O, P



280 GSM



Lightweight Hooded Sweat 1335

Adult Sweatshirt. 80% Cotton/ 20% Polyester 240 g/ m2.
 Erwachsene Sweatshirt. 80% Baumwolle/ 20% Polyester 240 g/ m2.
 Sweat-Shirt Adulte. 80% Coton/ 20% Polyester 240 g/ m2.
 Volwassene Sweatshirt. 80% Katoen/ 20% Polyester 240 g/ m2.

S, M, L, XL, XXL 24 Print Code: F(6), M, N(8), O, P



240 GSM



Lightweight Hooded Sweat 1300

Kids Sweatshirt. 80% Cotton/ 20% Polyester 240 g/ m2.
 Kinder Sweatshirt. 80% Baumwolle/ 20% Polyester 240 g/ m2.
 Sweat-Shirt Enfant. 80% Coton/ 20% Polyester 240 g/ m2.
 Kinder Sweatshirt. 80% Coton/ 20% Polyester 240 g/ m2.

5-6, 7-8, 9-11, 12-13, 14-15 24 Print Code: F(6), N(8), O, P



240 GSM



1123



150 GSM

Iconic Long Sleeve T 1330

Adult Colour T-Shirt. 100% Combed Cotton Ring Spun 150 g/ m2.
 Erwachsene Farbe T-Shirt. 100% Gekämmte Baumwolle Ring Spun 150 g/ m2.
 T-Shirt Adulte Couleur. 100% Coton Peigné Ring Spun 150 g/ m2.
 Kleuren T-Shirt Volwassene. 100% Gekamd Katoen Ring Spun 150 g/ m2.

Print Code: F(6), N(8), O, P
 S, M, L, XL, XXL



140 GSM

Iconic Long Sleeve T 1322

Adult White T-Shirt. 100% Combed Cotton Ring Spun 140 g/ m2.
 Erwachsene Weiß T-Shirt. 100% Gekämmte Baumwolle Ring Spun 140 g/ m2.
 T-Shirt Adulte Blanc. 100% Coton Peigné Ring Spun 140 g/ m2.
 Wit T-Shirt Volwassene. 100% Gekamd Katoen Ring Spun 140 g/ m2.

Print Code: F(6), N(8), O, P
 S, M, L, XL, XXL



180 GSM

Premium Long Sleeve 1380

Adult Polo Shirt. 100% Cotton Pique 180 g/ m2.
 Erwachsene Polo-Shirt. 100% Baumwolle Pique 180 g/ m2.
 Polo Adulte. 100% Coton Pique 180 g/ m2.
 Volwassene T-Shirt. 100% Katoen Pique 180 g/ m2.

Print Code: F(6), N(8), O, P
 S, M, L, XL, XXL



240 GSM

Lightweight Shorts 8015

Shorts. 80% Cotton/ 20% Polyester 240 g/ m2.
 Shorts. 80% Baumwolle/ 20% Polyester 240 g/ m2.
 Shorts. 80% Coton/ 20% Polyester 240 g/ m2.
 Shorts. 80% Katoen/ 20% Polyester 240 g/ m2.

Print Code: F(6), N(8), O, P
 S, M, L, XL, XXL



333

WITH POCKETS



240 GSM

Lightweight Open Hem 8018

Trousers. 80% Cotton/ 20% Polyester 240 g/ m2.
 Hose. 80% Baumwolle/ 20% Polyester 240 g/ m2.
 Pantalon. 80% Coton/ 20% Polyester 240 g/ m2.
 Broek. 80% Katoen/ 20% Polyester 240 g/ m2.

Print Code: F(6), N(8), O, P
 S, M, L, XL, XXL



08

02



333



Blossom 20169 280 GSM



Jacket. Polar Fleece 280 g/ m2. Anti-Pilling Treatment.
 Jacke. Polar Fleece 280 g/ m2. Anti-Pilling Behandlung.
 Veste. Polaire 280 g/ m2. Traitement Anti-Pilling.
 Jas. Polar Fleece 280 g/ m2. Anti-Pilling Behandlung.

XS, S, M, L, XL, XXL 15 Print Code: N(8), P



Anderson 20168 280 GSM



Vest. Polar Fleece 280 g/ m2. Anti-Pilling Treatment.
 Weste. Polar Fleece 280 g/ m2. Anti-Pilling Behandlung.
 Gilet. Polaire 280 g/ m2. Traitement Anti-Pilling.
 Vest. Polar Fleece 280 g/ m2. Anti-Pilling Behandlung.

XS, S, M, L, XL, XXL 30 Print Code: N(8), P



New

Arsuk 21095

160 GSM



Polar Fleece. 100% Polyester Micropolar 160 g/ m2. Anti-Pilling Treatment.
 Vlies. 100% Polyester Mikropolare 160 g/ m2. Anti-Pilling Behandlung.
 Veste. 100% Polyester Micropolaire 160 g/ m2. Traitement Anti-Pilling.
 Polar Fleece. 100% Polyester Micropolar 160 g/m2. Anti-Pilling Behandlung.

XS, S, M, L, XL, XXL 50 Print Code: F(6), N(8), P



19 08 06 02

**Peyten 4841**

155 GSM



Polar Fleece. 100% Polyester Micropolar 155 g/ m2. Anti-Pilling Treatment.
 Vlées. 100% Polyester Mikropolare 155 g/ m2. Anti-Pilling Behandlung.
 Veste. 100% Polyester Micropolaire 155 g/ m2. Traitement Anti-Pilling.
 Polar Fleece. 100% Polyester Micropolar 155 g/m2. Anti-Pilling Behandlung.

☞ S, M, L, XL, XXL 📦 25 🏷️ Print Code: N(8), P

**Hizan 4755**

280 GSM



Jacket. Polyester Polar Fleece 280 g/ m2. Anti-Pilling Treatment.
 Jacke. Polyester Polar Fleece 280 g/ m2. Anti-Pilling Behandlung.
 Veste. Polyester Polaire 280 g/ m2. Traitement Anti-Pilling.
 Jas. Polyester Polar Fleece 280 g/ m2. Anti-Pilling Behandlung.

☞ S, M, L, XL, XXL 📦 30 🏷️ Print Code: N(8), P

**Destin 20170**

280 GSM



Vest. Polyester Polar Fleece 280 g/ m2. Anti-Pilling Treatment.
 Weste. Polyester Polar Fleece 280 g/ m2. Anti-Pilling Behandlung.
 Gilet. Polyester Polaire 280 g/ m2. Traitement Anti-Pilling.
 Vest. Polyester Polar Fleece 280 g/ m2. Anti-Pilling Behandlung.

☞ XS, S, M, L, XL, XXL 📦 30 🏷️ Print Code: N(8), P

RPET 

1127

makito



Diston 1304 280 GSM

Jacket. Polyester Polar Fleece RPET 280 g/ m2. Anti-Pilling Treatment.
 Jacke. Polyester Polar Fleece RPET 280 g/ m2. Anti-Pilling Behandlung.
 Veste. Polyester Polaire RPET 280 g/ m2. Traitement Anti-Pilling.
 Jas. Polyester Polar Fleece RPET 280 g/ m2. Anti-Pilling Behandeling.

 S, M, L, XL, XXL  30  Print Code: N(8), P



Mesiox 1303 155 GSM

Polar Fleece. 100% Polyester Micropolar RPET 155 g/ m2. Anti-Pilling Treatment.
 Vlies. 100% Polyester Mikropolare RPET 155 g/ m2. Anti-Pilling Behandlung.
 Veste. 100% Polyester Micropolaire RPET 155 g/ m2. Traitement Anti-Pilling.
 Polar Fleece. 100% Polyester Micropolar RPET 155 g/ m2. Anti-Pilling Behandeling.

 S, M, L, XL, XXL  25  Print Code: N(8), P



RPET 

Scola 1305 300 GSM

Jacket. Outside: Soft Shell, 92% Polyester RPET/ 8% Elastane. Inside: 100% Polyester Microfleece RPET. 300 g/ m². Wind and Water Resistant.

Jacke. Äußere: Soft Shell, 92% Polyester RPET/ 8% Elastan. Innen: 100% Polyester Microfleece RPET. 300 g/ m². Beständig Gegen Wind und Wasser.

Veste. Extérieur: Soft Shell, 92% Polyester RPET/ 8% Élasthanne. Intérieur: 100% Polyester Microfleece RPET. 300 g/ m². Résistant au Vent et à l'Eau.

Jas. Buitenzijde: Soft Shell, 92% Polyester RPET/ 8% Elastaan. Binnenzijde: 100% Polyester Microfleece RPET. 300 g/ m². Bestand Tegen Wind en Water.

 S, M, L, XL, XXL  15  Print Code: N(8), P



Jandro 1306 300 GSM

Vest. Outside: Soft Shell, 92% Polyester RPET/ 8% Elastane. Inside: 100% Polyester Microfleece RPET. 300 g/ m². Wind and Water Resistant.

Weste. Äußere: Soft Shell, 92% Polyester RPET/ 8% Elastan. Innen: 100% Polyester Microfleece RPET. 300 g/ m². Beständig Gegen Wind und Wasser.

Gilet. Extérieur: Soft Shell, 92% Polyester RPET/ 8% Élasthanne. Intérieur: 100% Polyester Microfleece RPET. 300 g/ m². Résistant au Vent et à l'Eau.

Vest. Buitenzijde: Soft Shell, 92% Polyester RPET/ 8% Elastaan. Binnenzijde: 100% Polyester Microfleece RPET. 300 g/ m². Bestand Tegen Wind en Water.

 S, M, L, XL, XXL  20  Print Code: N(8), P





1129

makito

Seldon 20172



Grechel 20171



Molter 3854 300 GSM

Jacket. Outside: Soft Shell, 92% Polyester/ 8% Elastane. Inside: 100% Polyester Microfleece. 300 g/ m2. Wind and Water Resistant.
 Jacke. Äußere: Soft Shell, 92% Polyester/ 8% Elasthan. Innen: 100% Polyester Microfleece. 300 g/ m2. Beständig Gegen Wind und Wasser.
 Veste. Extérieur: Soft Shell, 92% Polyester/ 8% Élasthanne. Intérieur: 100% Polyester Microfleece. 300 g/ m2. Résistant au Vent et à l'Eau.
 Jas. Buitenzijde: Soft Shell, 92% Polyester/ 8% Elastaan. Binnenzijde: 100% Polyester Microfleece. 300 g/ m2. Bestand Tegen Wind en Water.

XS, S, M, L, XL, XXL 15 Print Code: N(8), P



Seldon 20172 300 GSM

Vest. Outside: Soft Shell, 100% Polyester. Inside: 100% Polyester Microfleece. 300 g/ m2. Wind and Water Resistant.
 Veste. Äußere: Soft Shell, 100% Polyester. Innen: 100% Polyester Microfleece. 300 g/ m2. Beständig Gegen Wind und Wasser.
 Gilet. Extérieur: Soft Shell, 100% Polyester. Intérieur: 100% Polyester Microfleece. 300 g/ m2. Résistant au Vent et à l'Eau.
 Vest. Buitenzijde: Soft Shell, 100% Polyester. Binnenzijde: 100% Polyester Microfleece. 300 g/ m2. Bestand Tegen Wind en Water.

XS, S, M, L, XL, XXL 20 Print Code: N(8), P



Grechel 20171 300 GSM

Jacket. Outside: Soft Shell, 100% Polyester. Inside: 100% Polyester Microfleece. 300 g/ m2. Wind and Water Resistant.
 Jacke. Äußere: Soft Shell, 100% Polyester. Innen: 100% Polyester Microfleece. 300 g/ m2. Beständig Gegen Wind und Wasser.
 Veste. Extérieur: Soft Shell, 100% Polyester. Intérieur: 100% Polyester Microfleece. 300 g/ m2. Résistant au Vent et à l'Eau.
 Jas. Buitenzijde: Soft Shell, 100% Polyester. Binnenzijde: 100% Polyester Microfleece. 300 g/ m2. Bestand Tegen Wind en Water.

XS, S, M, L, XL, XXL 15 Print Code: N(8), P

1130

makito

New



06



02



Brooke 20174



LIGHTWEIGHT & WARM GARMENT



WATER & WIND RESISTANT



REMOVABLE LABEL



UNISEX

Vest. 100% Polyester. Wind and Water Resistant.
 Weste. 100% Polyester. Beständig Gegen Wind und Wasser.
 Gilet. 100% Polyester. Résistant au Vent et à l'Eau.
 Vest. 100% Polyester. Bestand Tegen Wind en Water.

XS, S, M, L, XL, XXL 15 Print Code: N(8)

Bordy 6465



LIGHTWEIGHT & WARM GARMENT



WATER & WIND RESISTANT



REMOVABLE LABEL



UNISEX

Vest. Soft Shell/ Polyester. Wind and Water Resistant.
 Weste. Soft Shell/ Polyester. Beständig Gegen Wind und Wasser.
 Gilet. Soft Shell/ Polyester. Résistant au Vent et à l'Eau.
 Vest. Soft Shell/ Polyester. Bestand Tegen Wind en Water.

S, M, L, XL, XXL 15 Print Code: N(8), P





Belsan 6080



Vest. 100% Polyester. Wind and Water Resistant. Polyester Pouch Included.
 Weste. 100% Polyester. Beständig Gegen Wind und Wasser. Polyester Etui Inklusive.
 Gilet. 100% Polyester. Résistant au Vent et à l'Eau. Étui Polyester Inclus.
 Vest. 100% Polyester. Bestand Tegen Wind en Water. Zakje Inclusief.

S, M, L, XL, XXL 15 Print Code: N(8), P



POUCH INCLUDED



Toret 21146



Vest. Soft Shell/ Polyester. Wind and Water Resistant.
 Weste. Soft Shell/ Polyester. Beständig Gegen Wind und Wasser.
 Gilet. Soft Shell/ Polyester. Résistant au Vent et à l'Eau.
 Vest. Soft Shell/ Polyester. Bestand Tegen Wind en Water.

S, M, L, XL, XXL 15 Print Code: N(8), P

RPET 



02 06 08 04 18 13



POUCH INCLUDED



02 06 POUCH INCLUDED

Rostol 6757



Vest. 100% Polyester RPET. Wind and Water Resistant. Polyester RPET Pouch.
 Weste. 100% Polyester RPET. Beständig Gegen Wind und Wasser. Polyester RPET Etui.
 Gilet. 100% Polyester RPET. Résistant au Vent et à l'Eau. Étui Polyester RPET.
 Vest. 100% Polyester RPET. Bestand Tegen Wind en Water. Polyester RPET Zakje.

 S, M, L, XL, XXL  15  Print Code: N(8), P

Dempax 21147



Vest. 100% Polyester RPET. Wind and Water Resistant. Polyester RPET Pouch.
 Weste. 100% Polyester RPET. Beständig Gegen Wind und Wasser. Polyester RPET Etui.
 Gilet. 100% Polyester RPET. Résistant au Vent et à l'Eau. Étui Polyester RPET.
 Vest. 100% Polyester RPET. Bestand Tegen Wind en Water. Polyester RPET Zakje.

 XS, S, M, L, XL, XXL  15  Print Code: N(8), P



RPET

1133

makito

New



Likpan 21148



Jacket. 100% Polyester RPET. Wind and Water Resistant. Polyester RPET Pouch.
 Jacke. 100% Polyester RPET. Beständig Gegen Wind und Wasser. Polyester RPET Etui.
 Veste. 100% Polyester RPET. Résistant au Vent et à l'Eau. Étui Polyester RPET.
 Jas. 100% Polyester RPET. Bestand Tegen Wind en Water. Polyester RPET Zakje.

 XS, S, M, L, XL, XXL  15  Print Code: N(8), P



Mitens 6756



Jacket. 100% Polyester RPET. Wind and Water Resistant. Polyester RPET Pouch.
 Jacke. 100% Polyester RPET. Beständig Gegen Wind und Wasser. Polyester RPET Etui.
 Veste. 100% Polyester RPET. Résistant au Vent et à l'Eau. Étui Polyester RPET.
 Jas. 100% Polyester RPET. Bestand Tegen Wind en Water. Polyester RPET Zakje.

 S, M, L, XL, XXL  15  Print Code: N(8), P





LIGHTWEIGHT & WARM GARMENT



WATER & WIND RESISTANT



UNISEX



02

06

Kimpal 6759

Jacket. 100% Polyester. Wind and Water Resistant.
 Jacke. 100% Polyester. Beständig Gegen Wind und Wasser.
 Veste. 100% Polyester. Résistant au Vent et à l'Eau.
 Jas. 100% Polyester. Bestand Tegen Wind en Water.

Print Code: N(8), P



LIGHTWEIGHT & WARM GARMENT



WATER & WIND RESISTANT



REMOVABLE LABEL



UNISEX



Cornal 6466

Jacket. Soft Shell/ Polyester. Wind and Water Resistant.
 Jacke. Soft Shell/ Polyester. Beständig Gegen Wind und Wasser.
 Veste. Soft Shell/ Polyester. Résistant au Vent et à l'Eau.
 Jas. Soft Shell/ Polyester. Bestand Tegen Wind en Water.

Print Code: N(8), P



New



Pinkman 20176

Jacket. 100% Polyester. Wind and Water Resistant.
Jacke. 100% Polyester. Beständig Gegen Wind und Wasser.
Veste. 100% Polyester. Résistant au Vent et à l'Eau.
Jas. 100% Polyester. Bestand Tegen Wind en Water.

XS, S, M, L, XL, XXL 30 Print Code: N(8)



Polyester RPET Sherpa

New



Killian 20175

450 GSM



REMOVABLE LABEL

UNISEX

Jacket. Outside: Polyester RPET/ Sherpa. Inside: Polar Fleece 450 g/ m2. Anti-Pilling Treatment.
 Jacke. Äußere: Polyester RPET/ Sherpa. Innen: Polar Fleece 450 g/ m2. Anti-Pilling Behandlung.
 Veste. Extérieur: Polyester RPET/ Sherpa. Intérieur: Polaire 450 g/ m2. Traitement Anti-Pilling.
 Jas. Buitenzijde: Polyester RPET/ Sherpa. Binnenzijde: Polar Fleece 450 g/ m2. Anti-Pilling
 Behandeling.

XS, S, M, L, XL, XXL 15 Print Code: N(8), P



04



13



02



Flogox 4805

Parka. Outside: Polyester. Inside: Polyester/ Polar Fleece. Waterproof Treatment. Inside Zipper for Printing.
Parka. Außere: Polyester. Innen: Polyester/ Polar Fleece. Wasserdichte Behandlung. Innen Reißverschluss für Drucken.

Parka. Extérieur: Polyester. Intérieur: Polyester/ Polaire. Imperméable. Fermeture Intérieure pour l'Impression.
Parka. Buitenzijde: Polyester. Binnenzijde: Polyester/ Polar Fleece. Waterproof Behandeld. Ritssluiting Binnenkant Voor Bedrukking.

☞ S, M, L, XL, XXL ☞ 10 ☞ Print Code: N(8), P

Leanor 20173



Jacket. 100% Polyester. Wind and Water Resistant.

Jacke. 100% Polyester. Beständig Gegen Wind und Wasser.

Veste. 100% Polyester. Résistant au Vent et à l'Eau.

Jas. 100% Polyester. Bestand Tegen Wind en Water.

☞ XS, S, M, L, XL, XXL ☞ 10 ☞ Print Code: N(8)



Hinbow 4551



Raincoat. PVC.
Regenjacke. PVC.
Imperméable. PVC.
Regenjas. PVC.

☞ M-L, XL-XXL ☞ 25 ☞ Print Code: G(1)



Garu 3875



Raincoat. Polyester 190T.
Regenjacke. Polyester 190T.
Imperméable. Polyester 190T.
Regenjas. Polyester 190T.

☞ M, L, XL, XXL ☞ 50 ☞ Print Code: G(1)



Grid 9497



Raincoat. Polyester 190T.
Regenjacke. Polyester 190T.
Imperméable. Polyester 190T.
Regenjas. Polyester 190T.

☞ M-L, XL-XXL ☞ 50 ☞ Print Code: G(1)



Soviet 9487 

Vest. 35% Cotton/ 65% Polyester.
 Weste. 35% Baumwolle/ 65% Polyester.
 Gilet. 35% Coton/ 65% Polyester.
 Vest. 35% Katoen/ 65% Polyester.

 L, XL, XXL  50  Print Code: G(6), N(8), O, P



Kross 8025  

Reflective Vest. Polyester. One Size. Adult. Homologated.
 Warnweste. Polyester. Einheitsgrösse. Erwachsene. Zugelassen.
 Gilet Réfléchissant. Polyester. Taille Unique. Adulte. Homologué.
 Reflecterend Vest. Polyester. Eén Maat. Volwassen. Gehomologiseerd.

 65 x 70 cm  100 / 20  Print Code: G(6)



Jestol 21111  

Reflective Vest. Polyester. One Size. Adult. Homologated.
 Warnweste. Polyester. Einheitsgrösse. Erwachsene. Zugelassen.
 Gilet Réfléchissant. Polyester. Taille Unique. Adulte. Homologué.
 Reflecterend Vest. Polyester. Eén Maat. Volwassen. Gehomologiseerd.

 65 x 70 cm  100 / 20  Print Code: G(6)

31 CHRISTMAS & SEASONAL





CHRISTMAS
TEDDY

Nando 20136

Plush Toy, Polyester.
Plüschtier, Polyester.
Peluche, Polyester.
Pluche, Polyester.

Consult. 150 / 10 Print Code: N(8)



Glenda 5110

Keyring Teddy, Polyester.
Schlüsselanhänger Teddy, Polyester.
Porte-Clés Peluche, Polyester.
Sleutelhanger Teddybeer, Polyester.

9 x 10 x 6 cm 500 / 20 Print Code: E(1)



Kuisy 20134

Plush Toy, Polyester.
Teddy, Polyester.
Peluche, Polyester.
Teddybeer, Polyester.

15 x 16 x 12 cm 150 / 10 Print Code: N(8)



Kostan 20135

Plush Toy, Polyester.
Plüschtier, Polyester.
Peluche, Polyester.
Pluche, Polyester.

14 x 18,5 x 13 cm 150 / 10 Print Code: N(8)



Camiz 5918

Sock. Polyester. One Size 36-43. Anti-Slip.
 Socken. Polyester. Einheitsgröße 36-43. Rutschfest.
 Chaussette. Polyester. Taille Unique 36-43. Antidérapant.
 Sok. Polyester. Eén Maat 36-43. Anti-Slip.

Consult. 100 / 10
 Print Code: N(8)



Luka 20115

Scarf. Acrylic.
 Schal. Acryl.
 Écharpe. Acrylique.
 Sjaal. Acryl.

160 x 30 cm 80 / 40
 Print Code: N(8), O, P



Elenix 20114

Hat. Acrylic.
 Hut. Acryl.
 Bonnet. Acrylique.
 Muts. Acryl.

Consult. 100 / 10
 Print Code: N(8), O, P



03

160 x 130 cm

Landak 3882

Blanket. Polar Fleece 200 g/ m2. Anti-Pilling.
 Decke. Polar Fleece 200 g/ m2. Anti-Pilling.
 Couverture. Polaire 200 g/ m2. Anti-Pilling.
 Deken. Polar Fleece 200 g/ m2. Anti-Pilling.

160 x 130 cm 20
 Print Code: E(1), N(8), P



03

160 x 125 cm

Ricord 1371

Blanket. Coral Fleece/ Sherpa 380 g/ m2. Anti-Pilling.
 Decke. Coral Fleece/ Sherpa 380 g/ m2. Anti-Pilling.
 Couverture. Polaire Coral/ Sherpa 380 g/ m2. Anti-Pilling.
 Deken. Coral Fleece/ Sherpa 380 g/ m2. Anti-Pilling.

160 x 125 cm 10
 Print Code: E(1), N(8), P



01

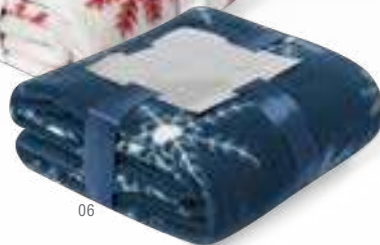

06



08



06



Carrigan 6905

Christmas Decoration. Wood. Magnetic. Chalk Included.
Ornament. Holz. Magnetisch. Kreide Inklusiv.
Ornement Noël. Bois. Magnétique. Craie Inclusive.
Kerstdecoratie. Hout. Magnetisch. Krijtje Inclusief.

13 x 15 x 0.6 cm 100 / 20 Print Code: D(1), L2

MAGNET



Gunter 6906

Allurex 20103



Christmas Decoration. Wood. 8 Leds. 2 Batteries AAA Not Included.
Ornament. Holz. 8 Leds. 2 AAA Batterien Nicht im Lieferumfang.
Ornement Noël. Bois. 8 Leds. 2 Piles AAA Non Inclusive.
Kerstdecoratie. Hout. 8 Leds. 2 Batterijen AAA Niet Inclusief.

21.5 x 35 x 5 cm 20 Print Code: E(4), L2

Sokin 6663



Christmas Tree. Wood.
Weihnachtsbaum. Holz.
Arbre de Noël. Bois.
Kerstboom. Hout.

11.5 x 17.7 x 3.1 cm 400 / 100 Print Code: D(4)

Gunter 6906



Christmas Decoration. Wood/ Acrylic.
Ornament. Holz/ Acryl.
Ornement Noël. Bois/ Acrylique.
Kerstdecoratie. Hout/ Acryl.

6.5 x 9.7 cm 100 / 50 Print Code: E(1), L1



Made in Europe

Rivond 2674

Magnet. Wood.
Magnet. Holz.
Magnet. Bois.
Magneet. Hout.

6.1 x 4.3 cm 800 / 200 Print Code: C(4), L1

MAGNET



Made in Europe

Lambet 2675

Magnet. Wood.
Magnet. Holz.
Magnet. Bois.
Magneet. Hout.

6 x 3.8 cm 800 / 200 Print Code: C(4), L1

MAGNET





Irise 2676

Made in Europe

Gemind 2677

Made in Europe

Holder. Wood.
Halter. Holz.
Support. Bois.
Houder. Hout.

9 x 14 x 7.7 cm 200 / 50
Print Code: D(4), L1

Christmas Decoration. Wood.
Ornament. Holz.
Ornément Noël. Bois.
Kerstdecoratie. Hout.

15.5 x 11 x 7.2 cm 200 / 50
Print Code: D(4), L1

Sigurd 20143

Christmas Card Decoration. Wood. Pine Seeds Included.
Ornament Weihnachtskarte. Holz. Piniensamen Inklusiv.
Ornément Lettre Noël. Bois. Graines de Pin Incluses.
Kerstkaart Decoratie. Hout. Pijnboom Zaden Inclusief.

11 x 15.5 x 0.5 cm 100
Print Code: D(1), E(1), L2



Rupol 6276

Christmas Decoration. Wood.
Ornament. Holz.
Ornément Noël. Bois.
Kerstdecoratie. Hout.

Ø 10 x 1 cm 200 / 100
Print Code: C(1), L1

UNIQUE PIECES FROM
NATURAL CUTS OF
WOOD. THE TEXTURE,
COLOR, SIZES AND
THICKNESS MAY VARY.



Fultom 20118

Christmas Decoration. Wood.
Ornament. Holz.
Ornément Noël. Bois.
Kerstdecoratie. Hout.

Consult. 1000 / 250
Print Code: C(1), L1

Tilmex 6903

Christmas Decoration Set. Wood. 3 Pieces.
Ornament Set. Holz. 3 Stück.
Set Ornément Noël. Bois. 3 Pièces.
Kerstdecoratie Set. Hout. 3 Stuks.

12 x 12 x 1.5 cm 400 / 200
Print Code: C(1), L1



SET
3 PIECES

ASK FOR PRICES - CONSULTAR PRECIOS

**Jorik 20116**

Christmas Decoration. Wood. Photos Size: 4 x 4 cm.
 Ornament. Holz. Photos: 4 x 4 cm.
 Ornement Noël. Bois. Photos: 4 x 4 cm.
 Kerstdecoratie. Hout. Foto's Maat: 4 x 4 cm.

Consult. 500 / 100
 Print Code: C(1), L1

**Roman 1372**

Christmas Decoration. Wood.
 Ornament. Holz.
 Ornement Noël. Bois.
 Kerstdecoratie. Hout.

9.5 x 12 x 0.6 cm 200 / 20
 Print Code: D(1), L1

**Shoilen 6310**

Wish Bottle. Glass.
 Wunsch-Dose. Glas.
 Bouteille à Souhaits. Verre.
 Wens fles. Glas.

Ø 3 x 7.4 cm 200 / 50
 Print Code: E(1), L1

PETUNIA SEEDS
**Boster 20117**

Seeds Christmas Decoration. Seed Paper. Petunia Seeds Included. Assorted Coloured Flowers.
 Samen Ornament. Samenpapier. Petuniensamen Inklusief. In verschillende Farben.
 Ornement Noël Ensemencé. Papier Ensemencé. Graines de Pétunia Incluses. Fleurs Couleurs Diverses.
 Zaad Kerstdecoratie. Zaadpapier. Petunia Zaden Inklusief. Assortiment van Gekleurde Bloemen.

Consult. 3000 / 100
 Print Code: A(4)

**Fantasy 9537**

Figures. Polyester.
 Figuren. Polyester.
 Figurines. Polyester.
 Beeldjes. Polyester.

9 x 9 x 0.2 cm 500 / 100
 Print Code: C(1), N(8)

**Chandun 20119**

Christmas Decoration Set. Felt. 3 Pieces.
 Ornament Set. Filz. 3 Stück.
 Set Ornement Noël. Feutrine. 3 Pièces.
 Kerstdecoratie Set. Vilt. 3 Stuks.

12 x 12 x 0.7 cm 500 / 250
 Print Code: C(1), N(8)



SET
 3 PIECES



Rimol 5898

Christmas Decoration Set. Polyester. 2 Pieces.
Ornament Set. Polyester. 2 Stück.
Set Ornement Noël. Polyester. 2 Pièces.
Kerstdecoratie Set. Polyester. 2 Stuks.

8 x 8 x 0.8 cm 1000 / 100
Print Code: C(1)



SET
2 PIECES



Yenkit 5107

Christmas Decoration Set. 6 Pieces.
Ornament Set. 6 Stück.
Set Ornement Noël. 6 Pièces.
Kerstdecoratie Set. 6 Stuks.

10 x 18 x 5 cm 100 Print Code: C(1)



SET
6 PIECES



B 8,8 X 10 X 0,5 CM

F 9,5 X 9,5 X 0,5 CM

Vondix 6349

Christmas Decoration. Slate.
Ornament. Schreiftafel.
Ornement Noël. Ardoise.
Kerstdecoratie. Leisten.

Consult. 100 / 25 Print Code: C(1)



Sasky 3800

Ball. Glass.
Kugel. Glas.
Sphère. Verre.
Sneeuw-Bol. Glas.

Ø 5 x 6.5 cm 100 / 25 Print Code: E(1)

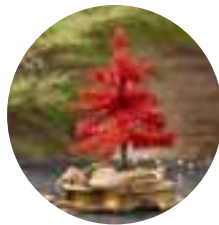

Pines 3363

Christmas Tree.
Weihnachtsbaum.
Arbre de Noël.
Kerstboom.

Ø 15 x 30 cm 200 / 50
Print Code: E(1)



Hilvira 20111

Set. Recycled Cardboard. 6 Pencilsand 6 Christmas Decoration Included.
Set. Recycling Pappe. 6 Stifte und 6 Ornament Inklusiv.
Set. Carton Recyclé. 6 Crayons et 6 Ornement Noël Incluses.
Set. Gerecycled Karton. 6 Potloden en 6 Kerstdecoratie Inclusief.

9.2 x 13 x 1.5 cm 200 / 50
Print Code: C(1)

ASK FOR PRICES - CONSULTAR PRECIOS



Cepex 20202

Heat Pack. Reusable.
Taschenwärmer. Wiederverwendbar.
Patch Chaleur. Réutilisable.
Warmte Pakket. Herbruikbaar.

Consult. 150 / 50 Print Code: E(1)

Yonsil 6908

Sock. Polyester.
Socle. Polyester.
Chaussette. Polyester.
Sok. Polyester.

23 x 35 cm 200 / 10 Print Code: E(1), N(8)



Saspi 3797

Sock. Polyester.
Socle. Polyester.
Chaussette. Polyester.
Sok. Polyester.

20 x 32 cm 200 / 10 Print Code: E(1), N(8)



Zisuk 4258

Pouch. Polyester.
Hülle. Polyester.
Étui. Polyester.
Hoes. Polyester.

8 x 19 cm 1000 / 50 Print Code: E(1), N(8)

04 19 02

Kunax 4260

Chair Cover. Polyester.
Stuhlhülle. Polyester.
Housse de Chaise. Polyester.
Stoel Hoes. Polyester.

50 x 62 cm 100 / 20 Print Code: F(1), N(8)



Mandi 3754

Coaster Set. Polyester. 4 Pieces.
Untersetzer Set. Polyester. 4 Stück.
Set Sous-Verre. Polyester. 4 Pièces.
Onderzetter Set. Polyester. 4 Stuks.

Ø 10 x 0.3 cm 500 / 50 Print Code: N(8)





KIDS



Flip 20101

Kids Christmas Hat. Polyester.
Kinder Weihnachtsmütze. Polyester.
Bonnet Papa Noël Enfant. Polyester.
Kinder Kerstmuts. Polyester.

27 x 40,5 cm 400 / 10 Print Code: E(1), N(8)

Rupler 5598

Kids Christmas Hat. Polyester/ Non-Woven. 4 Crayons Included.
Kinder Weihnachtsmütze. Polyester/ Non-Woven. 4 Wachsmalstifte Inklusive.
Bonnet Papa Noël Enfant. Polyester/ T.N.T. 4 Crayons Incluses.
Kinder Kerstmuts. Polyester/ Non-Woven. 4 Krijtjes Inclusief.

27 x 40,5 cm 300 / 50 Print Code: G(1), N(8)



23

09

Shiny 9833

Christmas Hat. Polyester.
Weihnachtsmütze. Polyester.
Bonnet Papa Noël. Polyester.
Kerstmuts. Polyester.

28 x 40 cm 250 / 10 Print Code: E(1), N(8)



Coyfel 20100

Christmas Hat. Polyester RPET.
Weihnachtsmütze. Polyester RPET.
Bonnet Papa Noël. Polyester RPET.
Kerstmuts. Polyester RPET.

30 x 43 cm 200 / 10 Print Code: E(1), N(8)

RPET



03

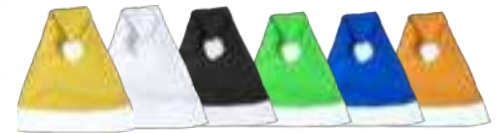

05

01

02

04

19

07

Papa Noel 8622

Christmas Hat. Polyester.
Weihnachtsmütze. Polyester.
Bonnet Papa Noël. Polyester.
Kerstmuts. Polyester.

30 x 43 cm 200 / 10 Print Code: E(1), N(8)



Lilnax 20104



Aromatic Candle. Glass/ Wood. Vanilla Aroma.
 Duftkerze. Glas/ Holz. Vanille Aroma.
 Bougie Aromatique. Verre/ Bois. Arôme Vanille.
 Geurkaars. Glas/ Hout. Vanille Aroma.

📏 Ø 7 x 10,3 cm 📦 40 🖨️ Print Code: E(1), L1



Jorin 1385

Aromatic Candle. Wood. Vanilla Aroma.
 Duftkerze. Holz. Vanille Aroma.
 Bougie Aromatique. Bois. Arôme Vanille.
 Geurkaars. Hout. Vanille Aroma.

📏 6,5 x 8,9 x 6,5 cm 📦 100 / 50 🖨️ Print Code: E(1), L1, L2



Keylax 6904

Aromatic Candle. Wood/ Glass. Vanilla Aroma.
 Duftkerze. Holz/ Glas. Vanille Aroma.
 Bougie Aromatique. Bois/ Verre. Arôme Vanille.
 Geurkaars. Hout/ Glas. Vanille Aroma.

📏 7,5 x 8 x 7,5 cm 📦 100 / 50 🖨️ Print Code: E(1), L1, L2



F - 9,5 X 1,5 X 9,5 CM

Deram 6279

Candle. Wood.
 Kerze. Holz.
 Bougie. Bois.
 Kaars. Hout.

🖨️ Consult. 📦 200 / 100 🖨️ Print Code: E(1), L1

B - 9,5 X 1,5 X 8,8 CM,



23

Zamir 5595

Candle. Glass.
 Kerze. Glas.
 Bougie. Verre.
 Kaars. Glas.

📏 Ø 5,6 x 6,8 cm 📦 100 🖨️ Print Code: E(1) 09



Clemen 1368

Magnet. 40 Sheets Notepad. Pencil Included.
Magnet. 40 Blätter Notizblock. Bleistift Inklusive.
Magnet. Bloc 40 Feuilles. Crayon Inclusé.
Magneet. 40 Blaadjes Notepad. Potlood Inclusief.

9.5 x 20.2 cm 200 / 50 Print Code: C(2)



Larry 1369

Magnet. 40 Sheets Notepad. Pencil Included.
Magnet. 40 Blätter Notizblock. Bleistift Inklusive.
Magnet. Bloc 40 Feuilles. Crayon Inclusé.
Magneet. 40 Blaadjes Notepad. Potlood Inclusief.

9.5 x 20.2 cm 200 / 50 Print Code: C(2)



Mossel 2699

Notebook. Bamboo. Hard Cover. 80 Sheets.
Notizbuch. Bambus. Hardcover-Abdeckung. 80 Blätter.
Cahier. Bambou. Couverture Rigide. 80 Feuilles.
Notitieboek. Bamboe. Harde Kaft. 80 Blaadjes.

17 x 21.5 x 1.8 cm 50 / 25 Print Code: E(1), L2



Noylax 2700

Notebook. Recycled Cardboard. Hard Cover. 80 Sheets.
Notizbuch. Recycling Pappe. Hardcover-Abdeckung. 80 Blätter.
Cahier. Carton Recyclé. Couverture Rigide. 80 Feuilles.
Notitieboek. Gerecycled Karton. Harde Kaft. 80 Blaadjes.

14.5 x 21 x 1 cm 40 / 20 Print Code: E(1)



ASK FOR PRICES - CONSULTAR PRECIOS



400 ml

500 ml

790 ml

**Yalok 6665**

Bottle. Stainless Steel. 790 ml.
Trinkflasche. Rostfreier Stahl. 790 ml.
Bidon. Acier Inox. 790 ml.
Fles. Roestvrij Staal. 790 ml.

Print Code: F(1)



370 ml

Sorbux 5193

Mug. Ceramic. 370 ml.
Tasse. Keramik. 370 ml.
Tasse. Céramique. 370 ml.
Mok. Keramiek. 370 ml.

Print Code: F(4)



350 ml

Nuglex 5192

Mug. Ceramic. 350 ml.
Tasse. Keramik. 350 ml.
Tasse. Céramique. 350 ml.
Mok. Keramiek. 350 ml.

Print Code: F(4)



320 ml

Tiffany 20122

Mug. Ceramic. 320 ml.
Tasse. Keramik. 320 ml.
Tasse. Céramique. 320 ml.
Mok. Keramiek. 320 ml.

Print Code: F(1)



DOUBLE WALL



SPECIAL PRINTING AREA

**Doglex 20125**

Mug. Borosilicate Glass. 400 ml.
Tasse. Borosilikat Glas. 400 ml.
Tasse. Verre Borosilicate. 400 ml.
Mok. Borosilicate Glas. 400 ml.

Print Code: F(1)



SPECIAL PRINTING AREA

**Katnis 20124**

Cups Set. Glass. 2 Pieces. 500 ml.
Trinkbecher Set. Glas. 2 Stück. 500 ml.
Set Verres. Verre. 2 Pièces. 500 ml.
Beker Set. Glas. 2 Stuks. 500 ml.

Print Code: F(1)



Ibergrin 20109

Bakery Set. Stainless Steel/ Wood. 5 Pieces.
 Backwaren Set. Rostfreier Stahl/ Holz. 5 Stück.
 Set Pâtisserie. Acier Inox/ Bois. 5 Pièces.
 Bakkers Set. Roestvrij Staal/ Hout. 5 Stuks.

40 x 6.5 x 6.5 cm 40
 Print Code: D(4), L1



Hellen 20110

Kitchen Set. Bamboe. 2 Pieces.
 Küchen Set. Bambus. 2 Stück.
 Set Cuisine. Bamboe. 2 Pièces.
 Keuken Set. Bamboe. 2 Stuks.

7 x 30.5 x 2 cm 100 / 50
 Print Code: B(4), E(1), L1



Margat 20108

Spatula. Silicone/ Wood.
 Spatel. Silikon/ Holz.
 Spatule. Silicone/ Bois.
 Spatel. Siliconen/ Hout.

4 x 20.5 x 1 cm 500 / 50 Print Code: D(4), L1



03



08



06



Verdux 1370

Mug. Ceramic. 280 ml.
 Tasse. Keramik. 280 ml.
 Tasse. Céramique. 280 ml.
 Mok. Keramiek. 280 ml.

Ø 8.6 x 8 cm 36 Print Code: F(1)

SPECIAL
 PRINTING
 AREA



Lienak 2689

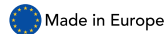

Kitchen Cutting Board. Wood.
 Brett. Holz.
 Planche à Découper. Bois.
 Keuken Snijplank. Hout.

17 x 21.5 x 0.6 cm 40 Print Code: E(4), L2, W



Danop 20106

Coaster Set. Cork. 4 Pieces.
 Untersetzer Set. Kork. 4 Stück.
 Set Sous-Verre. Liège. 4 Pièces.
 Onderzetter Set. Kurk. 4 Stuks.

10.2 x 1.3 x 10.2 cm 400 / 100
 Print Code: D(1), L1, W

ASK FOR PRICES - CONSULTAR PRECIOS

**Tidil 5466**

Pen.
Kugelschreiber.
Stylo.
Pen.

Consult. 1000 / 100 Print Code: B(4)

**Miffet 5940**

Pencil. Wood. Eraser Included.
Bleistift. Holz. Radiergummi Inklusive.
Crayon. Bois. Gomme Inclusive.
Potlood. Hout. Gum Inclusief.

2.7 x 19 x 1.3 cm 500 / 50
Print Code: B(4)

**Flop 5219**

Eraser Set. 4 Pieces.
Radlergummi Set. 4 Stück.
Set Gommies. 4 Pièces.
Gummen Set. 4 Stuks.

10 x 10.5 x 0.7 cm 300 / 50
Print Code: D(1)

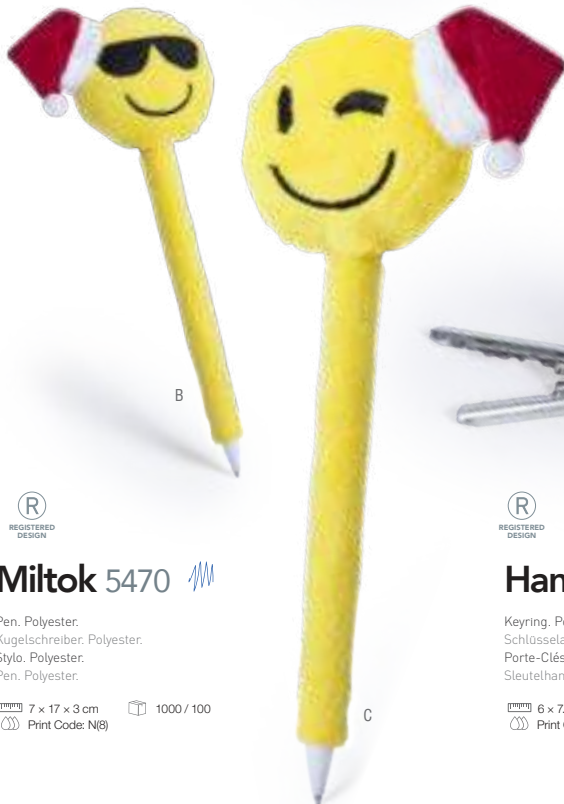
**Miltok 5470**

Pen. Polyester.
Kugelschreiber. Polyester.
Stylo. Polyester.
Pen. Polyester.

7 x 17 x 3 cm 1000 / 100
Print Code: N(8)

**Hansen 5469**

Keyring. Polyester.
Schlüsselanhänger. Polyester.
Porte-Clés. Polyester.
Sleutelhanger. Polyester.

6 x 7.3 x 3.2 cm 1000 / 100
Print Code: N(8)

**Pudox 5892**

Opener Keyring. Aluminium.
Schlüsselanhänger Flaschenöffner. Aluminium.
Porte-Clés Ouvre Boutelle. Aluminium.
Sleutelhanger Opener. Aluminium.

5.5 x 5.3 x 0.3 cm 1000 / 200
Print Code: D(4), L1



Napier 2705

Made in Europe

Game. Wood. 10 Pieces. Cotton Pouch.
Spiel. Holz. 10 Stück. Baumwolle Etui.
Jeu. Bois. 10 Pièces. Étui Coton.
Spel. Hout. 10 Stuks. Katoen Zakje.

13 x 18.5 cm 200 / 50
 Print Code: B(1), E(1), L1, N(8)



Aleko 20107

Skill Game. Wood. 36 Pieces. Cotton Pouch.
Geschicklichkeitsspiel. Holz. 36 Stück. Baumwolle Etui.
Jeu d' "Habileté. Bois. 36 Pièces. Étui Coton.
Behendigheidsspel. Hout. 36 Stuks. Katoen Zakje.

11 x 13.5 x 2.2 cm 200 / 50
 Print Code: F(1), N(8)



Wistick 5140

Bag. Non-Woven. 5 Crayons Included.
Tasche. Non-Woven. 5 Wachsmalstifte Inklusive.
Sac. T.N.T.. 5 Crayons Incluses.
Tas. Non-Woven. 5 Krijtjes Inclusief.

20.5 x 22 cm 100 / 50 Print Code: G(1)

Kertran 5941

Drawstring Bag. Non-Woven. 4 Crayons Included.
Rucksack. Non-Woven. 4 Wachsmalstifte Inklusive.
Sac à Dos. T.N.T.. 4 Crayons Incluses.
Rugzak. Non-Woven. 4 Krijtjes Inclusief.

25 x 30 cm 200 / 50 Print Code: G(1)

Plicom 5141

Stocking. Non-Woven. 5 Crayons Included.
Socken. Non-Woven. 5 Wachsmalstifte Inklusive.
Chaussette. T.N.T.. 5 Crayons Incluses.
Sok. Non-Woven. 5 Krijtjes Inclusief.

19 x 29.5 cm 100 / 50 Print Code: G(1)

UNIQUE OFFERS

Charger. Wireless 15W. Magnetic.
Ø 5.7 x 0.6 cm 200 / 100 Print Code: E(4), W

Viom 1284



COMPATIBLE WITH
MAGSAFE & Qi
TECHNOLOGY

(15W)
WIRELESS
CHARGER

Charger. Wireless 5W. Micro USB, Type C and Lightning Connection.
110 cm 300 / 100 Print Code: E(4)

Pikat 6259



2 in 1
MICRO USB &
LIGHTNING

Charger. Wireless 5W.
9.5 x 1.2 x 7.6 cm 200 / 50 Print Code: E(4), W

Zafren 6260

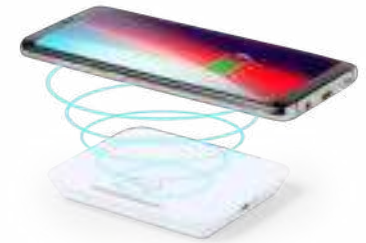

Charger. Polyester. Wireless 5W.
Ø 10 x 0.7 cm 100 / 50
Print Code: E(1), N(8)

Devel 6256



Power Bank. Aluminium. 2200 mAh. USB Output.
Micro USB and Type C Input. Cable Not Included.
6.5 x 9.5 x 0.8 cm 100 / 25
Print Code: E(4), W, L2

Villex 5776



2200
mAh

Power Bank. 2000 mAh. USB Output. Micro USB
Input. Cable Not Included.
5.9 x 9 x 3.8 cm 100 / 25
Print Code: E(4)

Privek 5960

2000
mAh



Charger. 4 USB Outputs.
15.5 x 7.8 x 12.7 cm 20 / 10
Print Code: G(4)

Zeeland 5769



Earphones. Ultraviolet Light. Bluetooth Connection. Battery 35 mAh/ Charging Station 400 mAh.

5.1 x 5.5 x 3.1 cm 100 / 50 Print Code: E(4), W

Coleman 6927

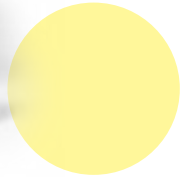

Earphones. Bluetooth Connection. Battery 40 mAh/ Charging Station 300 mAh.

6.3 x 5.1 x 2.7 cm 100 / 50 Print Code: E(4), W

Mainiky 1431



ACTIVE NOISE CANCELLING



Earphones. Aluminium. Bluetooth Connection. Battery 60 mAh.

7.5 x 13.6 x 3 cm 100 / 50 Print Code: E(4)

Voltar 5787

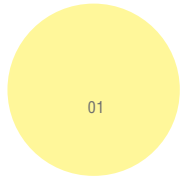
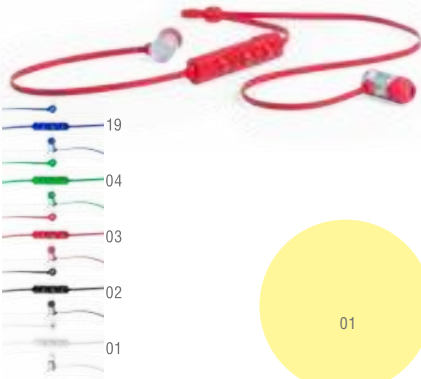

Earphones. Bluetooth Connection. Battery 60 mAh.

7.5 x 13.6 x 3 cm 100 / 50 Print Code: E(4)

Mayun 5337



Earphones. Wheat Straw/ ABS/ Bamboo/ Hemp. Bluetooth Connection. Battery 60 mAh.

9 x 4 x 2 cm 500 / 100 Print Code: E(4)

Lattimer 6922



Headphones. Polar Fleece. 3.5 mm Jack Socket.

27 x 6 cm 200 / 50 Print Code: N(8), P

Markiz 5142



Headphones. Bluetooth Connection. 3.5 mm Jack Socket. Battery 300 mAh.

19 x 17.5 x 7 cm 20 / 10 Print Code: F(1)

Tresor 5562



Smart Watch. TPU Strap. Bluetooth Connection. 1.69" TFT Screen. Wireless Rechargeable. Battery 180 mAh.

27 x 4 x 1.2 cm 50 Print Code: I(1), L2

Radman 1433

APP
COMPATIBLE WITH
ANDROID & iOS



WATCH WITH WIRELESS CHARGING / METAL CASING



Smart Bracelet. Silicone Strap. Bluetooth Connection. 0.49" LCD Screen. Battery 65 mAh.

25 x 2 x 1.1 cm 100 / 50 Print Code: I(1), L2

Wesly 5314



APP
COMPATIBLE WITH
ANDROID & iOS

- ANTILOST
- CALLS COUNTER
- ALARM
- HEALTH MONITORING
- REMOTE CAMERA
- SLEEP MONITORING
- VIBRATION
- CALLS NOTIFY
- TIME & DATE

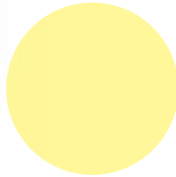

360° Camera. Micro USB and Type C Connection.

4.4 x 4.6 x 4 cm 50 Print Code: J(1)

Ribben 5771

APP

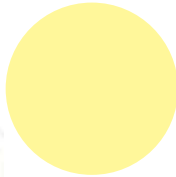
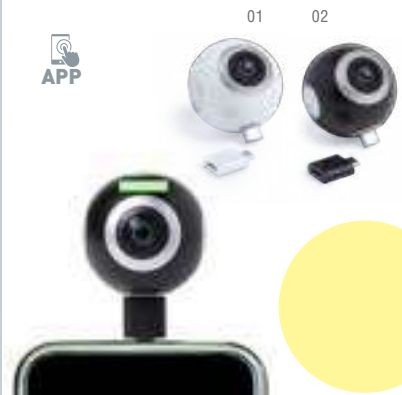

Smart Bracelet. TPU Strap. Bluetooth Connection. 0.96" TFT Screen. Battery 90 mAh.

25.5 x 2.2 x 1.1 cm 100 / 50 Print Code: A(1), I(1), L2

Yefer 1374



Speaker. Bluetooth Connection. Sound Power 3W. Battery 300 mAh.

15 x 5.6 x 5.8 cm 50 Print Code: F(1)

Morals 5154

- HANDS-FREE
- MICRO SD
- RADIO
- USB PLAYER
- LINE IN



01 03 19



Speaker. Bluetooth Connection. Sound Power 3W. Battery 400 mAh.

6 x 6.9 x 5.8 cm 50 Print Code: F(4)

Syrene 5566



HANDS-FREE
LINE IN



Speaker. Silicone.

11 x 4.5 x 4.5 cm 300 / 10 Print Code: F(1)

Superbass 4189



01

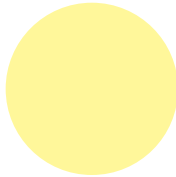

Charger. Wireless 5W. 3 USB Outputs.

Ø 9.4 × 3.9 cm 40/20
Print Code: E(4), W

Mandux 5955



Charging Cable. Suitable for data transfer. Micro USB and Lightning Connection 5V DC 1A.

1.3 × 5.3 × 1.1 cm 500/250
Print Code: C(4)

Holnier 5741



Charging Cable. Suitable for data transfer. Type C Connection 5V DC 1A.

1.5 × 43.5 × 1.1 cm 500/50
Print Code: C(1)

Doffer 5785

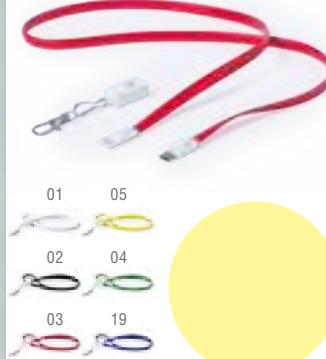

Charging Cable. Micro USB Connection 5V DC 1A.

1.5 × 11 × 1.1 cm 300/50
Print Code: C(1)

Pirten 5065



USB Memory. Metal.

3.9 × 6.1 × 0.4 cm 200/50
Print Code: L1

Drelan 8GB 5761



USB Memory. Metal/ Acrylic. Led Lights.

Ø 2.9 × 6.2 cm 200/50
Print Code: L1

Sleut 8GB 5757



USB Memory. Led Lights.

3.7 × 5.9 × 0.9 cm 500/50
Print Code: D(4), L1

Novuk 16GB 6234



USB Hub. 3 Hubs. USB 2.0.

3.5 × 24 × 1 cm 200/50
Print Code: D(4)

Pod 3899



USB Hub. 4 Hubs. USB 2.0.

5.4 × 4 × 5.4 cm 200/50
Print Code: D(4), W

Dix 4635





UNIQUE OFFER

Keyboard. Bluetooth Connection. Battery 1000 mAh.

20 x 0.6 x 12.5 cm 50 / 25 Print Code: F(2)

Volks 4935



Keyboard Holder. PU. Bluetooth Connection. Battery 1000 mAh.

22 x 2.2 x 14.5 cm 40 / 20 Print Code: F(2), L2

Dustin 5739



Keyboard Holder. PU. Bluetooth Connection. Battery 1000 mAh.

22 x 1.1 x 14.3 cm 40 / 20 Print Code: F(2), L2

Tyrell 5305



Mouse. Foldable. Wireless. Optical. 2 Batteries AAA Not Included.

11.3 x 2.9 x 5.6 cm 100 Print Code: E(4), W

Lenbal 5948



Webcam Cover. Screen Cleaner Included.

3 x 2.4 x 1.8 cm 1000 / 100 Print Code: B(4), V

Fewek 5740



Webcam Cover Joystick.

2.7 x 3.4 x 1.5 cm 500 / 100 Print Code: B(1)

Maint 5800

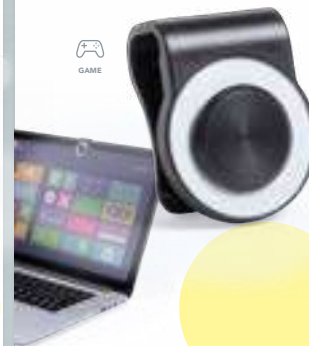

Webcam Cover. Adhesive. 3 Pieces.

3.5 x 3.5 x 1.8 cm 2000 / 1000 Print Code: B(4), W

Pembol 6085



Universal Lenses. 2 Glass Lenses/ Aluminium. Polyester Pouch.

9 x 12 x 2.5 cm 100 Print Code: D(1), N(8)

Drian 4947

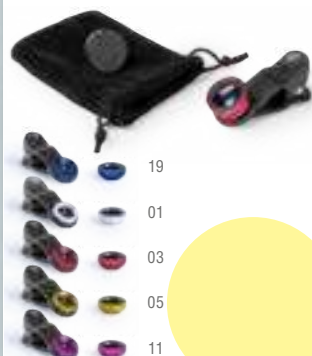

Set. Stainless Steel. Earphones 3,5 mm Jack Socket. Selfie Stick 7 Positions. 3 Glass Lenses/ Aluminium.

8.2 x 15 x 3.4 cm 100 / 50 Print Code: E(1), L1, N(8)

Altum 4940



Universal Lenses. 4 Lenses.

11 x 14.5 x 3 cm 200 / 50 Print Code: D(1)

Bagly 5632



3D Lens.

10 x 12 x 3 cm 200 / 50 Print Code: D(4)

Wills 5633



Gamepad. Bluetooth Connection. Battery 180 mAh.

3.1 x 7.3 x 1.5 cm 200 / 50 Print Code: D(4)

Station 5157



Flash. 4 Leds. Button Batteries Included.

3.5 x 5.4 x 1.3 cm 1000 / 100 Print Code: C(4)

Fotovindex 5368



Virtual Reality Glasses.

10.9 x 8.4 x 6.3 cm 200 / 50 Print Code: D(4)

Bolnex 5329



Selfie Stick. Stainless Steel. 3.5 mm Jack Socket. 7 Positions.

1.7 x 106 cm 50 Print Code: E(4), L1

Nefix 4627



Selfie Stick. Stainless Steel. 3.5 mm Jack Socket. 4 Positions.

1.8 x 52 cm 100 / 50 Print Code: E(4), L1

Rontiver 5392



Selfie Stick. Stainless Steel. 3.5 mm Jack Socket. 7 Positions.

2.6 x 60 cm 100 / 50 Print Code: E(1), L1

Paicom 4932



Power Bank Selfie Stick. Aluminium/ Stainless Steel. 2200 mAh. USB Output. Micro USB Input. 3.5 mm Jack Socket. 7 Positions.

2.2 x 69 cm 50 / 25 Print Code: E(1), L1

Slatham 5200



Selfie Stick. Stainless Steel. 3.5 mm Jack Socket. 7 Positions.

2.5 x 108 x 2.5 cm 50 / 25 Print Code: E(4), L1

Kroper 4855



Stylus Touch Pen.

1.4 x 9 cm 500 / 25 Print Code: B(4)

Cirex 4343



Holder Pouch. Silicone. Adhesive.

5.7 x 9.4 x 1 cm 500 / 100
Print Code: L1

Lepol 5681



Multipurpose Pouch. Silicone.

5.6 x 8.9 x 0.5 cm 1000 / 100
Print Code: F(1)

Lotek 4283



Protector Pouch. Polyester. RFID Protected.

12.5 x 19 cm 500 / 100
Print Code: E(1), N(8)

Hismal 6007



Card Holder. RFID Protected. 1 Compartment. Adhesive.

6.2 x 9 cm 4000 / 100
Print Code: B(1)

Recol 6363



Multipurpose Bag. PVC. Waterproof. Touch Screen.

21 x 31 cm 300 / 50
Print Code: F(1)

Kirot 4860



Multipurpose Bag. PVC. Waterproof. Touch Screen.

21 x 27.5 x 14.3 cm 200 / 50
Print Code: F(1)

Tuzar 5068



Pouch. Microfibre.

8.5 x 13.5 cm 500 / 50
Print Code: E(1), N(8)

Mim 3732



Tablet Case. PU.

23 x 26.5 x 1.5 cm 40
Print Code: G(1)

Yari 4134



Tablet Case. Microfibre.

23 x 28 cm 100 / 20
Print Code: F(1), N(8)

Mega 3731



Holder. Adhesive.
 7.5 x 2.2 x 0.5 cm 1000 / 100 Print Code: L1

Manfix 5999

02 08

Protector Holder. ABS/Silicone.
 10.2 x 6.2 x 0.6 cm 500 / 100 Print Code: E(1)

Sernel 6304

01 02 03 19

Holder. Silicone. Adhesive.
 5 x 10.1 x 0.5 cm 1000 / 100 Print Code: D(1)

Smaner 5022

01 02 03 19

Holder.
 3.2 x 8 x 2.5 cm 400 / 50 Print Code: C(4), W

Beltrak 5650

08 01

Holder. Flexible.
 12.3 x 6.4 x 2.8 cm 50 Print Code: H(1)

Brenom 6065

Dashboard Holder. Sticky Surface.
 15 x 11 x 10 cm 50 Print Code: D(1)

Wantol 5749

Mobile Holder.
 9 x 9.5 x 6 cm 500 / 50 Print Code: D(4)

Lerix 3778

01 02 03 19

Holder. Cork. Magnetic.
 3.9 x 2.7 x 3.9 cm 200 / 100 Print Code: C(4), L1

Priot 1283

Screen Cleaner. Microfibre. Sticky Surface.
 3 x 3 cm 10000 / 100 Print Code: C(1)

Nopek 4243

02 04 03 01 11 19 05

Holder.
 3.8 x 4 cm 600 / 100 Print Code: D(4)

Rumy 4103

03 02 19 05

Cord Winder.
 4 x 10 x 0.3 cm 1000 / 200 Print Code: C(4)

Bael 4267

19 02 01 03 05

Holder. Adhesive.

Ø 2.8 x 1.6 cm 2000 / 200
Print Code: Consulnar

Mita 3540



Cleaning Set. 2 Accessories.

8.9 x 2.9 x 8.4 cm 200 / 100
Print Code: C(4), W

Naibel 4014



Organizer Band. Nylon.

2 x 18 x 0.2 cm 2000 / 100
Print Code: D(1)

Landi 3701



Mousepad. Silicone. Anti-Slip.

Ø 19.3 cm 250 / 50
Print Code: F(1)

Exfera 4577

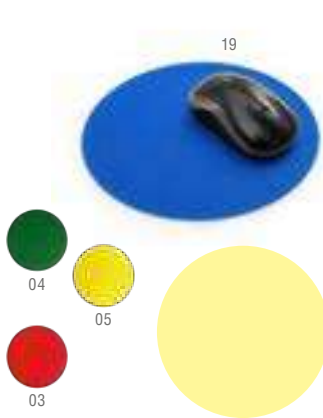

Mousepad Photo Frame. PVC/ EVA. Photos Size: 15 x 10 cm. Anti-Slip.

23 x 18 cm 400 / 100
Print Code: E(4)

Pictium 4242



Mousepad. Microfibre/ Silicone. Anti-Slip.

22 x 18 cm 400 / 50
Print Code: E(1), R

Serfat 5781

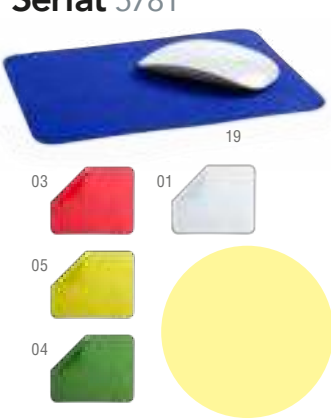

Bookmark. Aluminium.

5.5 x 13.5 x 1.5 cm 200 / 20
Print Code: D(4), L1

Melby 4548

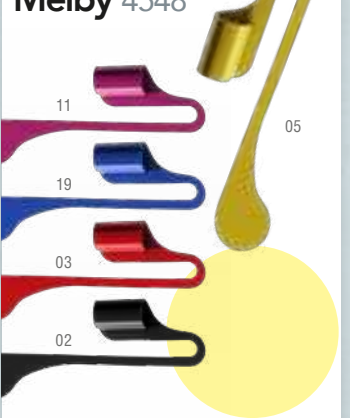

Clip Bookmark. Metal.

3 x 4.5 cm 500 / 50
Print Code: E(4), L1

Carex 7217



Bookmark. Metal.

2.4 x 14.2 x 0.4 cm 200 / 50
Print Code: E(4), L1

Baloa 7227



Letter Opener. Metal.

2.8 x 15.8 x 0.4 cm 200 / 20
Print Code: E(4), L1

Prax 7218

■■ ANTONIO MIRO ■■



Calculator. Bamboo/ABS. Solar. 12 Digits. Button Battery Included.

9.3 x 17.3 x 1.1 cm 80 / 40 Print Code: D(4), L1

Greta 1243

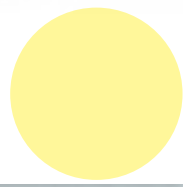

Calculator. Water Powered. Dispenser Included.

7.4 x 12.6 x 1.7 cm 200 / 20 Print Code: D(4)

Ozone 9736

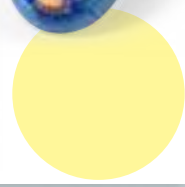

Clips Holder. 20 Clips Included.

9.3 x 2.1 x 4.6 cm 300 / 50 Print Code: B(1), D(4), L1, W

Bomtel 5612



Clip.

3.5 x 5.6 x 1.2 cm 1000 / 50 Print Code: C(4)

Yonsy 4708

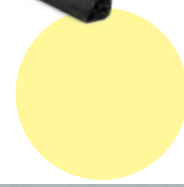

Bookmark. Magnetic.

2 x 6 x 0.2 cm 2000 / 500 Print Code: C(4)

Sumit 3932



Notepad. Cardboard. 30 Sticky Notes 4,5 x 6 cm. 50 Mini Sticky Notes 1,2 x 4,5 cm.

5.4 x 10 x 6.5 cm 500 / 100 Print Code: C(4)

Novich 5795



Notepad. Hard Cover. 80 Sheets.

14.5 x 21.5 x 2 cm 40 / 20 Print Code: G(1)

Velmont 5932

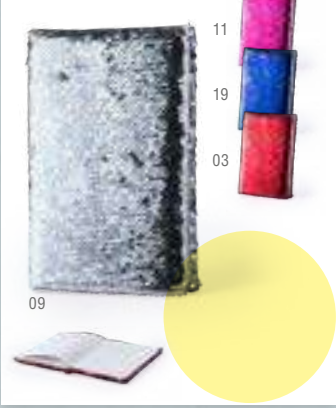

Notebook. Recycled Cardboard. Hard Cover. 80 Sheets.

15.7 x 21.5 x 2.2 cm 40 / 20 Print Code: E(4)

Veldun 6566

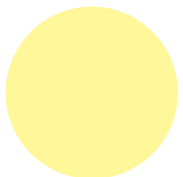

Notepad. Polyester 300D. Hard Cover. 80 Sheets.

12.7 x 17.8 x 1.3 cm 50 / 25 Print Code: E(4), N(8)

Talfor 6193

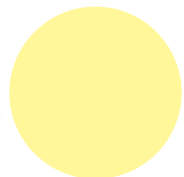

Notepad. PU. Hard Cover. 80 Sheets.

8.8 x 14.3 x 1.3 cm 100 / 50 Print Code: E(4), T

Clibend 5123

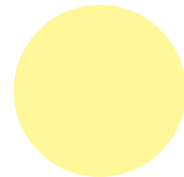

Folder. Polyester 600D. 20 Sheets Notepad.

24.8 x 32.3 x 1 cm 40
Print Code: F(1), N(8)

Roftel 4516

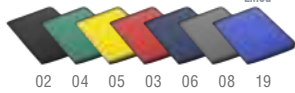

02 04 05 03 06 08 19



Folder. Cork. 20 Sheets Notepad.

24.5 x 32.5 x 1.5 cm 20
Print Code: F(1), L1, N(8)

Hoyeb 5027



Folder. Polyester 600D. 20 Sheets Notepad.

25.4 x 33.5 x 1.5 cm 20
Print Code: F(1), N(8)

Conquer 3646



03



Shoulder Bag. Non-Woven.

30 x 37 x 7 cm 250 / 50
Print Code: F(1)

Jasmine 9843



03



07



19



02

Multipurpose Bag. Felt.

8.5 x 14.5 cm 500 / 100
Print Code: F(1), N(8)

Cisko 4092



02

19

03

05

Document Bag. PVC.

33.5 x 24.5 cm 300 / 10
Print Code: F(1)

Bonx 4576



19

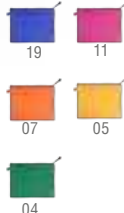

19

11

07

05

04

Document Holder. Felt.

35 x 25 cm 80 / 20
Print Code: F(1), N(8)

Dago 4130



03

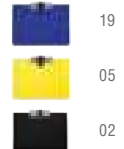

19

05

02

Organizer. PP. 12 Dividers.

26 x 14 x 2 cm 100 / 25
Print Code: F(1)

Lemek 3873



19

03

01

Multipurpose Bag. Polyester.

12 x 5.5 x 2.5 cm 500 / 10
Print Code: E(1), N(8)

Nila 9235



19

07

03

Multipurpose Bag. Polyester.

6 x 10.6 x 3.2 cm 1000 / 10
Print Code: E(1), N(8)

Misu 9258



19

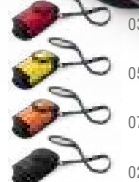

03

05

07

02

Shoulder Bag. Polyester 600D.

14 x 18.5 x 7.5 cm 100 / 20
Print Code: F(1), N(8), O

Piluto 8547



05

Shoulder Bag. Polyester 600D.

10 x 15.5 x 8 cm 100 / 10
Print Code: F(1), N(8), O

Karan 9675



07

Multifunction Notepad. PU. Power Bank 3000 mAh. USB Output. Micro USB Input. 65 Sheets Notepad.
 17.5 x 22.5 x 2.5 cm 20 Print Code: G(1)

Hoopel 5397



3000 mAh
 65 Sheets Lined



UV Sterilizer Organizer. Polyester 600D/ PU. Ultra-violet Light. RFID Protected. USB Connection.
 12 x 18.5 x 4 cm 50 / 25 Print Code: G(1), N(8)

Boxny 6674

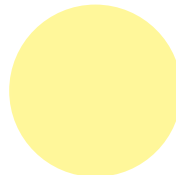

Charger Organizer. PU. Wireless 5W.
 11.1 x 21.5 x 2 cm 100 / 20 Print Code: G(1), N(8)

Merson 6326



Multifunction Laptop Pouch. Nylon 1200D. Padded.
 34.5 x 27.5 x 4 cm 20 Print Code: N(8)

Wattan 6914



15" LAPTOP COMPARTMENT



Document Bag. Microfibre.
 38 x 39 cm 50 Print Code: N(8)

Kani 4119

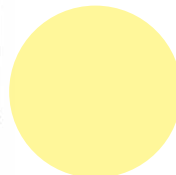

Document Bag. Polyester 600D.
 40 x 29 x 11.5 cm 25 Print Code: G(1), N(8)

Celmar 5582



Antibacterial Backpack. Polyester 600D. Padded. Padded Laptop Compartment.
 30 x 43 x 14 cm 20 Print Code: G(1), N(8)

Mordux 6704



TROLLEY STRAP
 ANTI-BACTERIAL
 15" LAPTOP COMPARTMENT

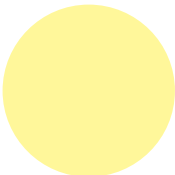

Backpack. Laminated Recycled Paper 130 g/ m2. Padded Shoulder Straps.
 30 x 40 x 14 cm 50 Print Code: G(1)

Dons 6371



Backpack. Laminated Recycled Paper 130 g/ m2. Padded Shoulder Straps.
 30 x 40 x 14 cm 50 Print Code: G(1)

Kizon 6370



Backpack Bag. Ripstop. Foldable.

52 x 27 x 26 cm 50 / 10
Print Code: F(1), G(1), H(1)

Ribuk 4779

02 03 11 19



Drawstring Bag. Polyester 190T.

34 x 42 cm 300 / 50
Print Code: F(1), N(8), R

Telner 5621

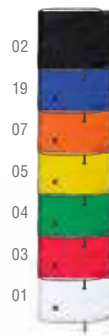

Drawstring Bag. Polyester 210D.

31 x 43 cm 200 / 10
Print Code: F(1), N(8), R

Bicalz 5588



Drawstring Bag. Polyester 210T.

35 x 45 cm 200 / 10
Print Code: F(1), N(8), R

Sibert 4592



Lanyard. Polyester.

2 x 50 cm 800 / 100
Print Code: G(1), N(8), R

Tremen 5288

01 02 03 19 07 05



Lanyard. Cork / Wheat Straw / PP. Safety Catch.

2 x 50 cm 1000 / 100
Print Code: D(1)

Merul 6885



Antibacterial Lanyard. Polyester.

2 x 50 cm 1000 / 100
Print Code: G(1), N(8), R

Yest 6884



Drawstring Bag. Tyvek® Material.

34 x 42 cm 200 / 20
Print Code: F(1)

Sandal 6429



Lanyard. Polyester. Adjustable.

1.5 x 48 cm 2000 / 100
Print Code: D(1)

Menfix 6716

01 02 03 04 19



Lanyard. Nylon 190T. Waterproof. Safety Catch.

2 x 55 cm 300 / 50
Print Code: F(1)

Bob 9937

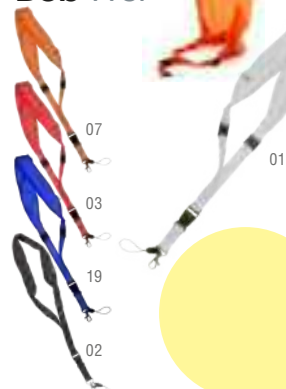

Lanyard. Polyester.

2 x 55 cm 600 / 100
Print Code: G(1), N(8), R

Duble 8846



Lanyard. Silicone.

1.5 x 40 cm 500 / 50
Print Code: D(1)

Sigex 4213

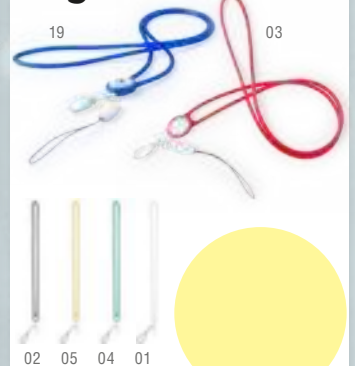

Bottle. Glass/Stainless Steel. 500 ml. Not suitable for sublimation.

Ø 6.3 x 22 cm 50 Print Code: F(1), L1, WR

Eltron 1261

500 ml

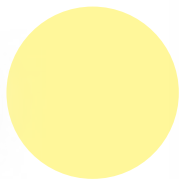

Bottle. Stainless Steel/ Cork. 750 ml.

Ø 7.4 x 25.7 cm 50 Print Code: F(1), L2, L3, WR

Rekka 6880

750 ml

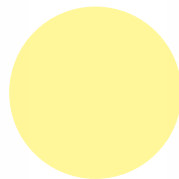

Bottle. Stainless Steel/ Bamboo. 750 ml.

Ø 7.4 x 25.7 cm 50 Print Code: F(1), L2, L3, WR

Syrma 6879

750 ml

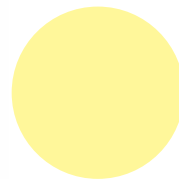

Juicer Bottle. Tritan/Stainless Steel. 700 ml.

Ø 7.3 x 25 cm 50 Print Code: F(1), L2

Selmy 5555

700 ml

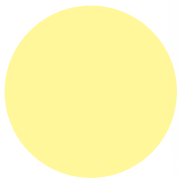

Bottle. Tritan. 650 ml.

Ø 6.7 x 25 cm 50 Print Code: F(1), L2, WR

Halmik 5887

650 ml

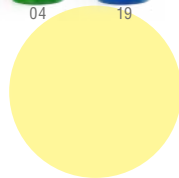

Juicer Bottle. Tritan. 780 ml.

Ø 7.5 x 26.5 cm 50 Print Code: F(1)

Raensen 5499

780 ml

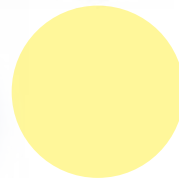

Bottle. Tritan. 700 ml.

Ø 7 x 24.5 cm 50 Print Code: F(1)

Kelit 5017

700 ml

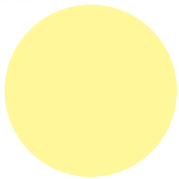

Bottle. Tritan. 820 ml.

Ø 7.4 x 24.5 cm 50 Print Code: F(1)

Rudix 6584

820 ml



Bottle. Tritan. 780 ml.

Ø 7 x 24.7 cm 50 Print Code: F(1), WR

Lobrok 5559

780 ml

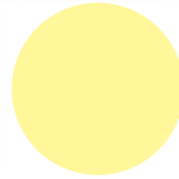

Bottle Cooler. PET. 400 ml.
 12 x 26.5 x 3 cm 100
 Print Code: E(1)

Luthor 4381 400 ml

01

Bottle. PET. 480 ml.
 16 x 21 x 3.3 cm 400 / 50
 Print Code: E(1)

Match 5296 480 ml

303 302 312 313

304

Bottle. PE. 750 ml.
 Ø 7.3 x 25 cm 20
 Print Code: F(1)

Radnel 2632 750 ml

Made in Europe

Bottle. PE. 500 ml.
 Ø 7.3 x 18.6 cm 20
 Print Code: F(1)

Dunfor 2631 500 ml

Made in Europe

Insulated Cup. Stainless Steel. 450 ml.
 Ø 8.4 x 17.9 cm 50
 Print Code: F(1), L1, WR

Domex 6403 450 ml

19 11 07 04 02 01

03

DOUBLE WALL

Insulated Cup. Stainless Steel/ Cork. 500 ml.
 Ø 8 x 17.5 cm 30
 Print Code: F(1), L1, WR

Shifen 6299 500 ml

DOUBLE WALL

Cup. PP. 450 ml.
 Ø 9.3 x 13.4 cm 50
 Print Code: F(1), WR

Kavior 1158 450 ml

Cup. Borosilicate Glass/ PU. 400 ml.
 Ø 9.2 x 11.4 cm 30
 Print Code: F(1), L1

Teils 1391 400 ml

Mug. Ceramic. 350 ml.
 Ø 9 x 10.5 cm 36
 Print Code: F(4)

Margot 3189 350 ml

03 04 07 19

02

Mug. Ceramic. 370 ml. Chalk Included.
 Ø 8.2 x 9.8 cm 36
 Print Code: F(1)

Dariel 5038 370 ml

05 16 19

03

Jar. Glass. 450 ml.

Ø 7.8 x 12.7 cm 36
Print Code: F(1), L2

Drunax 5733



450 ml

Jar. PS. 600 ml.

Ø 8.5 x 13.5 cm 50
Print Code: F(1)

Sirex 4820



600 ml

Straw. Silicone. Reusable.

Ø 5.4 x 2 cm 500 / 100
Print Code: C(4), W

Parix 6291

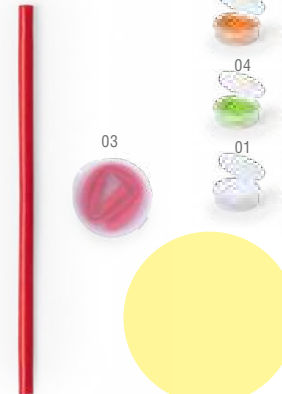

Straw Set. Paper. 10 Pieces.

3.2 x 20 x 1.3 cm 500 / 100
Print Code: C(1), A(1), W

Lantux 6290

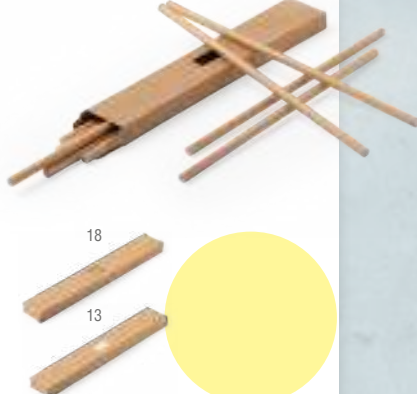

Jar. PP. 710 ml.

Ø 11.5 x 12.5 cm 40
Print Code: F(1)

Gorex 4873



710 ml

Lunch Box. Stainless Steel/ PP. 500 ml.

Ø 8.7 x 15.3 cm 20
Print Code: L1

Foxyn 1122



500 ml

Thermal Bag. Laminated Recycled Paper/ Aluminium.

30 x 30 x 15 cm 100 / 50
Print Code: F(1)

Laral 6063



Cool Bottle. Polyester 600D/ PVC. Suitable for Bottle 1,5 L.

Ø 11 x 33.5 cm 100 / 20
Print Code: F(1), N(8)

Fresher 3074



Bag. 100% Cotton 145 g/ m2.

40 x 40 x 10 cm 200 / 10 Print Code: F(6), N(8), O, P

Áloe 9844



145 g/m²



Bag. Laminated Recycled Paper 105 g/ m2/ Cotton.

48 x 35 x 15 cm 100 / 10 Print Code: F(1)

Palzim 6822



105 g/m²

Bag. Tyvek® Material.

38 x 42 cm 200 / 20 Print Code: F(1)

Naisa 6428



Bag. Bamboo Fibre 105 g/ m2.

37 x 41 cm 200 / 50 Print Code: F(1)

Bamtox 6158



Bag. Laminated Polyester RPET.

37.5 x 40.5 cm 100 / 10 Print Code: F(1)

Helena 9848



Bag. 100% Recycled Cotton 140 g/ m2.

38 x 42 cm 200 / 25 Print Code: F(6), N(8), O, P

Kromex 2664



Made in Europe

140 g/m²

Bag. 100% Cotton 140 g/ m2.

38 x 42 cm 200 / 25 Print Code: F(6), N(8), O, P

Lombak 2663



Made in Europe

140 g/m²

Foldable Bag, Polyester 170T.
 40 x 42 cm 400 / 10
 Print Code: F(1), G(1)

Velia 3976

158 261

Foldable Bag, Polyester 190T.
 40 x 38 cm 400 / 10
 Print Code: F(1), G(1)

Sukrem 5424

319 316 317 318

Foldable Bag, Polyester 190T.
 42.5 x 38 x 7 cm 400 / 20
 Print Code: E(1), G(1), H(1), R

Persey 4468

01 05 03 11
02 07 04 19

Foldable Bag, Non-Woven.
 45 x 33 x 12 cm 200 / 10
 Print Code: F(1), G(1), H(1)

Austen 3246

01 02 03 19

Bag, Felt.
 39 x 33 x 8 cm 60 / 10
 Print Code: F(1), N(8)

Rubby 4133

03 07

Bag, Non-Woven.
 39 x 42 x 11 cm 200 / 10
 Print Code: F(1)

Kastel 5098

19 01 02 03 04 05 07 11



Bag. Polyester 600D. Beauty Bag Included.

52.5 x 38.5 x 18 cm 30 Print Code: G(1), N(8)

Maxi 9384



Bag. Laminated Non-Woven.

31 x 40 x 10 cm 200 / 10 Print Code: F(1)

Ides 3167



Bag. PVC.

29 x 33 x 8 cm 50 / 10 Print Code: F(1)

Rastek 4985



Waste Bag Dispenser. 15 Bags Included.

5 x 7.6 x 3.2 cm 200 / 50 Print Code: C(4)

Bluck 5646



Bag Set. Polyester RPET. 3 Pieces.

25 x 30 cm 250 / 50 Print Code: F(1), R

Topin 6852

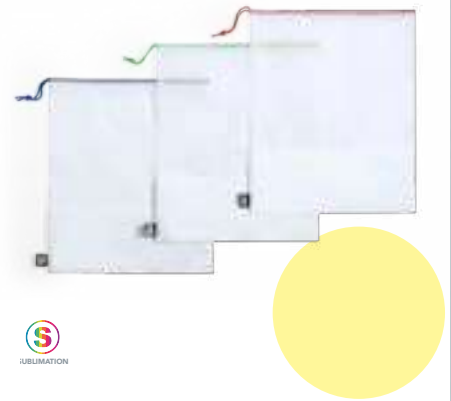

Bag Holder.

4 x 7.5 x 3.4 cm 1000 / 50 Print Code: C(4)

Taker 3936



Trash Bag Holder. Recycled Cardboard.

30 x 41 x 20 cm 30 / 15 Print Code: E(1)

Cart 2429



Plastic Bag Holder. Polyester 210D.

Ø 14 x 39 cm 1000 / 50 Print Code: F(1)

Doxen 4925



Pen. Bamboo/ Wheat Straw/ ABS. Jumbo Refill.

Ø 1.1 x 13.9 cm 1000 / 50 Print Code: B(4)

Lettek 6610

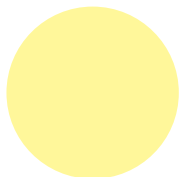

Pen. Bamboo/ Wheat Straw/ ABS. Jumbo Refill.

Ø 1.1 x 13.7 cm 1000 / 50 Print Code: B(4)

Trepol 6609

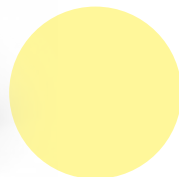

Pen. Bamboo/ Wheat Straw/ ABS. Jumbo Refill.

Ø 1.3 x 14 cm 1000 / 50 Print Code: B(4)

Patrok 6608

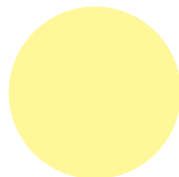

Pen. Bamboo/ Wheat Straw/ ABS.

Ø 1 x 13.9 cm 1000 / 50 Print Code: B(4)

Roak 6941



- 02
- 03
- 13
- 16
- 19

Pen. Bamboo.

Ø 1.3 x 14.2 cm 1000 / 50 Print Code: B(4)

Dafen 6369

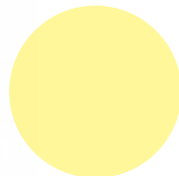

- 01
- 02
- 03
- 19
- 16

Pen. Bamboo.

Ø 0.9 x 14.7 cm 1000 / 50 Print Code: B(4)

Unkox 6081

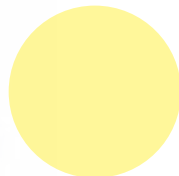

- 19
- 16
- 03
- 02

Pen. Wood. Jumbo Refill.

Ø 1.1 x 13.7 cm 1000 / 50 Print Code: B(1), L1

Carony 1487

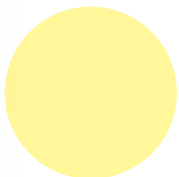

Eternal Pencil. Wood.

Ø 0.8 x 13.7 cm 1000 / 50 Print Code: B(1), L1

Fargox 1488

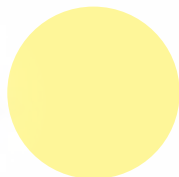

Pen. ABS/ Bamboo. Jumbo Refill.

Ø 1 x 13.7 cm 1000 / 50 Print Code: B(4), L1

Yackets 1405



Stylus Touch Ball Pen. ABS/ Bamboo. Jumbo Refill.

Ø 1 x 13.9 cm 1000 / 50 Print Code: B(4), L1

Grunt 1406



Stylus Touch Ball Pen. ABS/ Bamboo.

Ø 1 x 13.5 cm 1000 / 50 Print Code: B(4), L1

Layrox 1404

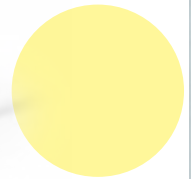

Pen. Aluminium. Jumbo Refill.

Ø 1 x 14 cm 500 / 50 Print Code: B(4), L1

Ploder 6026



- 02
- 03
- 04
- 19
- 05

Pen. Aluminium. Jumbo Refill.

Ø 1.1 x 13.5 cm 500 / 50 Print Code: B(4), L1

Fokus 3527

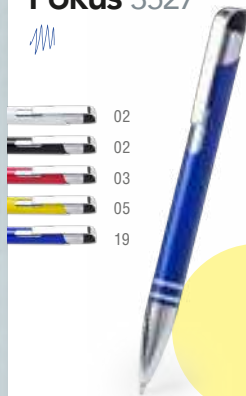

- 02
- 02
- 03
- 05
- 19

Pen. Aluminium.

Ø 0.8 x 13.5 cm 1000 / 50 Print Code: B(4), L1

Danus 5012



- 07
- 04
- 09

Pen. Aluminium. Jumbo Refill.

Ø 1 x 13.7 cm 500 / 50 Print Code: B(4), L1

Laindok 6071

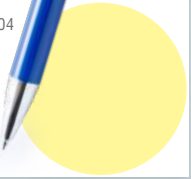

- 05
- 01
- 02
- 03
- 04
- 19

Pen. Aluminium. Jumbo Refill.

Ø 0.8 x 13.9 cm 1000 / 50 Print Code: B(4), L1

Pirke 4973

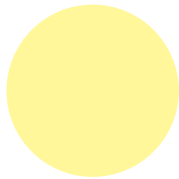

- 11
- 01
- 02
- 03
- 04
- 05
- 07
- 19

Pen. Aluminium.

Ø 0.9 x 13.4 cm 1000 / 50 Print Code: B(4), L1

Sufit 4714



- 04
- 01
- 11

Holder Pen. Aluminium. Screen Cleaner Included.

Ø 1 x 14.1 cm 500 / 50 Print Code: B(4), L1

Idris 5792

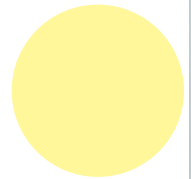

- 02

Stylus Touch Ball Pen. Metal.

Ø 1 x 14 cm 500 / 50 Print Code: B(4), L1

Walik 4882



11 07 02



05

Stylus Touch Ball Pen. Jumbo Refill.

Ø 1.2 x 14.2 cm 1000 / 50 Print Code: A(4)

Yeiman 6076



05 04 01 02 03 07



19

Stylus Touch Ball Pen.

Ø 0.9 x 12.5 cm 1000 / 50 Print Code: A(4)

Nilf 4646



03

Stylus Touch Ball Pen. Aluminium.

Ø 0.9 x 12.5 cm 1000 / 50 Print Code: B(4), L1

Lisden 5016



04 11



05

Stylus Touch Ball Pen. Aluminium.

Ø 0.9 x 11.2 cm 1000 / 50 Print Code: B(4), L1

Silum 3980



03 02 01



19

Stylus Touch Ball Pen. Aluminium.

Ø 1 x 13.7 cm 500 / 50 Print Code: B(4), L1

Fisar 5122



19 01 02 03



09

Stylus Touch Ball Pen. Aluminium.

Ø 0.9 x 12.5 cm 1000 / 50 Print Code: B(4), L1

Balki 4597



04

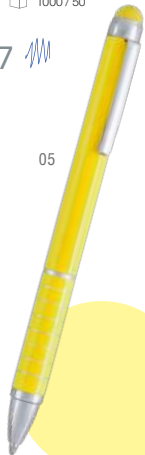

05

Stylus Touch Ball Pen.

Ø 0.9 x 12.5 cm 1000 / 50 Print Code: A(4)

Haspor 5417



19 02



05

Stylus Touch Ball Pen. Aluminium.

Ø 0.9 x 12.5 cm 1000 / 50 Print Code: B(4), L1

Neyax 4598



03



05

Stylus Touch Ball Pen.

Ø 1.2 x 13.4 cm 1000 / 50 Print Code: A(4), W

Monds 6022



07 16 05 03 02 01 11



19

Stylus Touch Ball Pen.

Ø 1 x 14 cm 1000 / 50 Print Code: A(4)

Rulets 5206

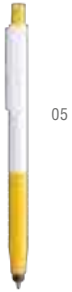

Stylus Touch Ball Pen.

Ø 1.1 x 14.7 cm 1000 / 50 Print Code: A(4), W

Zalem 5601



Holder Pen.

Ø 1.1 x 14.6 cm 1000 / 50 Print Code: A(4), W

Sipuk 5348

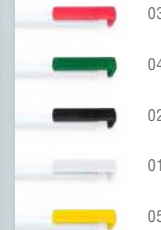

Stylus Touch Ball Pen. Jumbo Refill.

Ø 1.5 x 14 cm 1000 / 50 Print Code: A(4)

Vamux 4297



Stylus Touch Ball Pen.

Ø 1 x 14.3 cm 1000 / 50 Print Code: A(4)

Naitel 4307



Stylus Touch Ball Pen. Black Ink. Screen Cleaner Included.

Ø 1 x 14.3 cm 1000 / 50 Print Code: A(4)

Tesku 4890



Stylus Touch Ball Pen. Black Ink.

Ø 1 x 14 cm 1000 / 50 Print Code: A(1)

Motul 4895

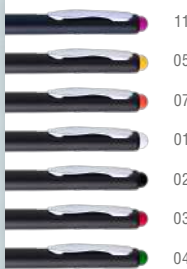

Stylus Touch Ball Pen.

Ø 1.3 x 14 cm 1000 / 50 Print Code: A(4)

Lombys 4647



Stylus Touch Ball Pen. Aluminium. Black Ink.

Ø 0.9 x 13.3 cm 1000 / 50 Print Code: B(4), L1

Rondex 5224



Pen. Jumbo Refill.

Ø 1.5 x 14 cm 1000 / 50 Print Code: A(4)

Gallery 9663



19

- 01
- 02
- 03
- 04
- 07

Pen.

Ø 1 x 14.5 cm 1000 / 50 Print Code: A(4)

Lucke 4727

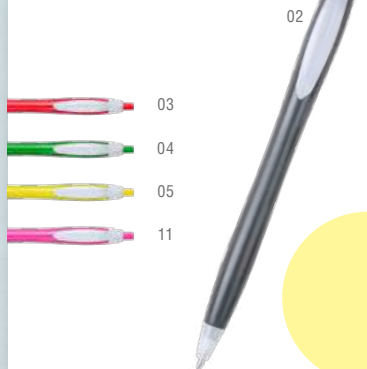

02

- 03
- 04
- 05
- 11

Pen. Jumbo Refill.

Ø 1.5 x 13 cm 1000 / 50 Print Code: A(4)

Píxel 9777

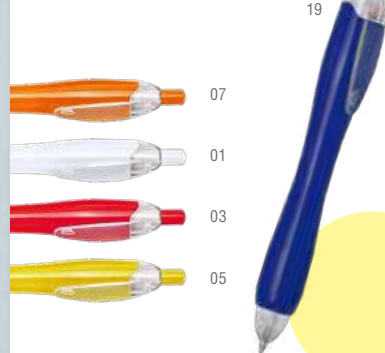

19

- 07
- 01
- 03
- 05

Pen. Jumbo Refill.

Ø 1.1 x 14 cm 1000 / 50 Print Code: A(4)

Velny 5294



11

- 04
- 03
- 07

Pen.

1 x 14.5 x 0.8 cm 2000 / 100 Print Code: A(4), W

Dafnel 6035

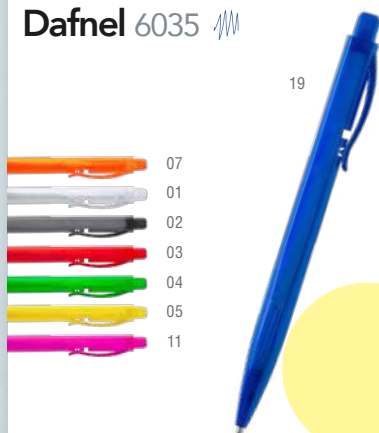

19

- 07
- 01
- 02
- 03
- 04
- 05
- 11

Holder Pen.

Ø 1.3 x 14 cm 1000 / 50 Print Code: A(4)

Cropix 5576

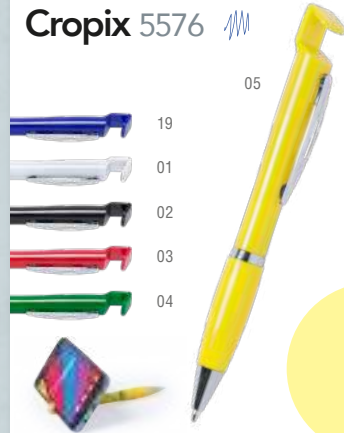

05

- 19
- 01
- 02
- 03
- 04

Pen.

Ø 1.1 x 14.4 cm 1000 / 50 Print Code: A(4)

Lachem 5833



19

- 05
- 04
- 07
- 01
- 02
- 03
- 11

Pen.

Ø 1.2 x 14.2 cm 500 / 50 Print Code: B(4)

Teins 5812

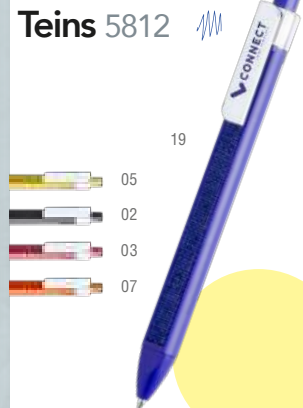

19

- 05
- 02
- 03
- 07

Pen.

Ø 0.9 x 14 cm 1000 / 50 Print Code: B(1)

Tullen 5602

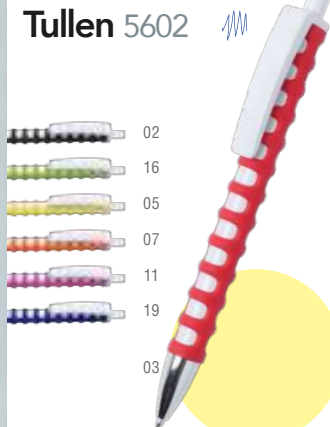

02

- 16
- 05
- 07
- 11
- 19
- 03

Pen. Aluminium. Jumbo Refill.

1.7 x 14.8 x 1 cm 500 / 50 Print Code: B(4), L1

Xenik 6077

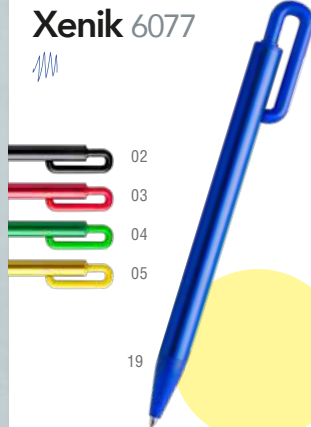

19

- 02
- 03
- 04
- 05

Pen. Black Ink.
 Ø 1.3 x 14 cm 1000 / 50 Print Code: A(4)

Karium 5168

19 05

Pen. Jumbo Refill.
 Ø 1.2 x 13.5 cm 1000 / 50 Print Code: A(4)

Buke 4366

11 03

Pen.
 Ø 1.1 x 13.5 cm 1000 / 50 Print Code: A(4)

Boder 5006

11 04



Pen.
 Ø 1.2 x 13.5 cm 1000 / 50 Print Code: B(4), L1

Tanety 5832

01 02 03 04 19

Pen.
 Ø 1.2 x 14.6 cm 1000 / 50 Print Code: A(4)

Bolmar 5449

19 04 02 01 03

Pen. RPET.
 Ø 1.1 x 14.1 cm 1000 / 50 Print Code: A(4)

Andrio 6730

01 04 03 19

RPET

Pen.
 Ø 1 x 13.6 cm 1000 / 50 Print Code: A(4)

Oasis 2541

03 04 19 01

STYB
 Made in Spain

Pen.
 Ø 1.1 x 13.3 cm 1000 / 100 Print Code: A(4)

Glamour 2545

05 02

CARIOCA

Pen.
 Ø 1.1 x 14 cm 1000 / 50 Print Code: A(4)

Halibix 5293

- 01
- 02
- 03
- 04
- 05
- 07
- 09
- 11
- 19



Pen.
 Ø 1.1 x 13.7 cm 1000 / 50 Print Code: A(4), W

Banik 5416

- 119
- 120
- 123
- 05
- 04
- 03
- 02
- 01



Pen. Jumbo Refill.
 1.3 x 14.5 x 1 cm 1000 / 50
 Print Code: A(4), W

Flixon 6028



Pen.
 Ø 1 x 14 cm 1000 / 100
 Print Code: A(4), W

Spinning 2544



- 19
- 01
- 02
- 03
- 04

05



CARIOCA

Pen.
 Ø 1 x 13.8 cm 1000 / 50
 Print Code: A(4), W

Morek 5010

- 04
- 05
- 19
- 03
- 02
- 01

11



Pen.
 Ø 0.9 x 13.7 cm 1000 / 50
 Print Code: A(4)

Dexir 4897



05



03

Roller.
 Ø 1.1 x 13.5 cm 1000 / 50
 Print Code: B(4)

Hembrock 5608



- 07
- 03
- 04
- 02
- 01

19



Roller. Jumbo Refill.
 Ø 1 x 14 cm 1200 / 50
 Print Code: A(4)

Estrim 9303



- 02
- 03
- 04

19



Roller.
 Ø 1 x 13.7 cm 1000 / 50
 Print Code: A(4)

Alecto 3856



- 02
- 04
- 03

19





Stylus Touch Ball Pen. Led Lights. Button Batteries Included.

Ø 1.3 x 14.7 cm 500 / 50 Print Code: B(4), L1

Renseix 5584

- 19
- 02
- 03
- 04
- 09

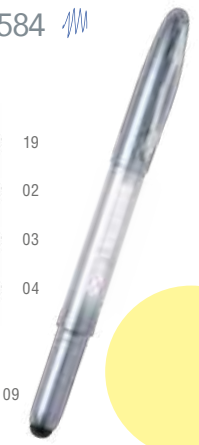

Pen. Aluminium.

Ø 1.1 x 14.1 cm 500 / 50 Print Code: B(4), L1

Wencex 6033

- 19
- 02
- 04
- 05
- 07
- 03
- 11



Pen. Aluminium.

Ø 1 x 14 cm 500 / 50 Print Code: B(4), L1

Sultik 7353

- 19
- 02
- 03
- 04
- 09



ANTONIO MIRO

Pen. Aluminium.

Ø 1 x 13.9 cm 200 / 50 Print Code: D(4), L1

Samber 7336



ANTONIO MIRO

Pencil Set. 3 Pencils.

2.2 x 18 x 1 cm 600 / 30 Print Code: D(1), B(4)

Sentel 7236



ANTONIO MIRO

Pen. Jumbo Refill.

Ø 1 x 13.4 cm 500 / 50 Print Code: A(4)

Parma 3294

- 01
- 02
- 03
- 04
- 19



Alexluca Italy

Pen. Aluminium. Jumbo Refill. PU Pouch.

Ø 1.2 x 13 cm 400 / 50 Print Code: C(4), L1

Pilman 3554

- 03
- 19
- 02



Alexluca Italy

Stylus Touch Ball Pen. Metal. Black Ink.

Ø 1 x 13.5 cm 72 / 36 Print Code: D(4), L1

Tech 2 7331

- 09
- 03
- 04
- 02

19



CROSS

Spray Pen. 3 ml. Liquid Not Included.

Ø 1.4 x 15.7 cm 1000 / 50
Print Code: B(4)

Tromix 6655

3 ml

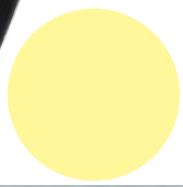

Spray Pen. 10 ml. Liquid Not Included.

Ø 1.2 x 18 cm 1000 / 50
Print Code: B(4)

Dixter 6657

10 ml

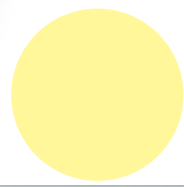

Multifunction Antibacterial Pen. 3 ml. Liquid Not Included.

Ø 1.4 x 11.3 cm 1000 / 50
Print Code: B(4)

Fruk 6723

3 ml



Antibacterial Stylus Touch Ball Pen. Jumbo Refill.

Ø 1 x 13.9 cm 1000 / 50
Print Code: B(4)

Topen 6693

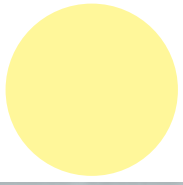

Antibacterial Pencil. Wood.

Ø 0.7 x 18.6 cm 2000 / 100
Print Code: B(4), L1

Sukon 6766

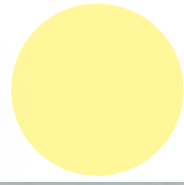

Antibacterial Set. PP. 4 Pieces. Pen. Mechanical Pencil: 0.5 mm Leads Included.

3.4 x 16.5 x 1.5 cm 300 / 50
Print Code: D(1), B(4), W

Riply 6765

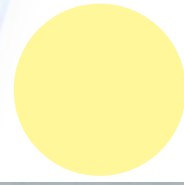
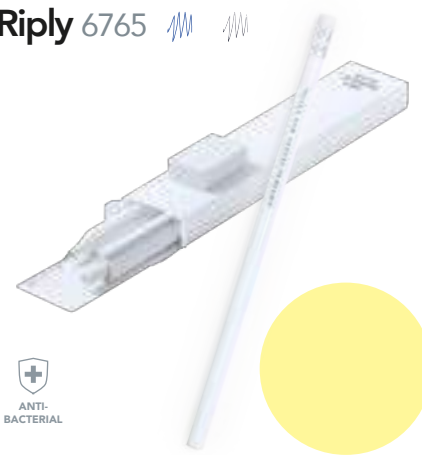

Stylus Touch Ball Pen. Aluminium.

Ø 2.1 x 15 cm 250 / 25
Print Code: C(4), L1

Bolcon 4546

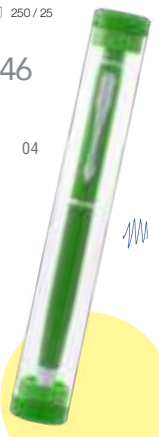

Pen. Aluminium. Jumbo Refill. PU Pouch.

Ø 1.1 x 13.5 cm 500 / 50
Print Code: C(4), L1

Gavin 3218

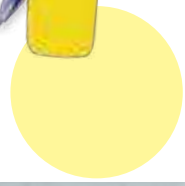

Stylus Touch Ball Pen. Metal. Jumbo Refill.

Ø 2.4 x 15.6 cm 250 / 25
Print Code: C(4), L1

Hasten 4798

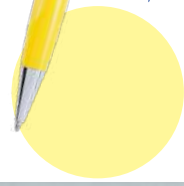
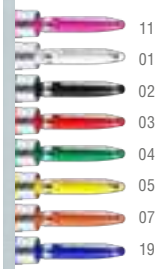

Set. Jumbo Refill Pen. Mechanical Pencil: 0.7 mm Leads Included.

Ø 1.1 x 14.2 cm 250 / 25
Print Code: D(1), B(4)

Velus 4357

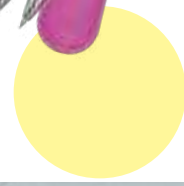

Pen. Jumbo Refill.
 3.9 x 13.9 x 1.9 cm 500 / 50
 Print Code: B(4)

Karsol 6027

19
11
07
05
03
02
01

16

Antistress Pen.
 1.8 x 12.4 x 1.8 cm 500 / 50
 Print Code: B(4)

Lennox 5825

03
04
01
02
05

19

Pen.
 Ø 2 x 15.3 cm 1000 / 50
 Print Code: B(4)

Basley 6443

04
01
03
07

19

Pen. Marker Included.
 Ø 1.3 x 15 cm 1000 / 50
 Print Code: A(4)

Lakan 6365

04 05 19 03

Stylus Touch Ball Pen. Screen Cleaner Included.
 Ø 3.8 x 12.5 cm 500 / 25
 Print Code: C(4)

Alzar 4661

11
03
04
05
02
01
19

Stylus Touch Ball Pen. Screen Cleaner Included.
 Ø 3 x 10.5 cm 1000 / 50
 Print Code: C(4)

Siria 4281

Pen. Jumbo Refill. Get Ink.
 Ø 0.8 x 17.2 cm 1000 / 50
 Print Code: B(4)

Ladys 5909

22

01

Stylus Touch Ball Pen. Metal.
 Ø 1 x 12.8 cm 1000 / 50
 Print Code: B(4)

Globix 4405

03 02 19 01

Pal Pal Pen.
 10.3 x 19.4 x 0.9 cm 1000 / 50
 Print Code: C(4)

Paipen 5911

19
01
03
04
05
11

Pen. Liquid Not Included.
 15.5 x 3 x 1.7 cm 500 / 50
 Print Code: C(4)

Pump 3136

05 03 19

Pen Torch. 2 Leds. Button Batteries Included.
 Ø 2.1 x 13 cm 500 / 50
 Print Code: B(4)

Mustap 4524

279 05 19 03 04

Pencil. Wood.

Ø 0.7 x 19 cm 2000 / 100 Print Code: A(4)

Graf 3851

- 124
- 19
- 05
- 04
- 03
- 192



Stylus Touch Pencil. Wood.

Ø 0.7 x 19 cm 2000 / 100 Print Code: B(4), L1

Dilio 5644



- 13
- 01
- 02

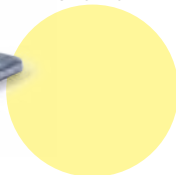

Pencil. Wood.

Ø 0.7 x 18.6 cm 2000 / 100 Print Code: A(4), L1

Naftar 6070

- 19
- 02
- 03
- 04
- 05
- 07
- 11



Pencil Case. Non-Woven/ PVC. 6 Pieces.

22 x 11.8 cm 200 / 50 Print Code: F(1)

Baiku 3616



Set. Cardboard. 4 Pieces.

6.5 x 22 x 1 cm 400 / 20 Print Code: C(1)

Laptan 4709

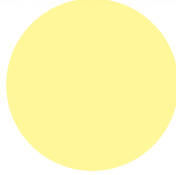

Multipurpose Bag. Polyester 600D.

18.5 x 10.5 cm 500 / 10 Print Code: F(1), N(8), O

Nabel 7263



HelloKitty



Ruler. 15 cm and 6".

16 x 4.2 x 0.2 cm 1000 / 100 Print Code: D(4), W

Hebe 3811



- 03
- 05
- 19



Eraser Set. 4 Pieces.

3.4 x 3.7 x 2.8 cm 200 / 50 Print Code: B(4)

Crats 4808



Whiteboard. Felt Tip Pen and Eraser Included.

19.8 x 17 x 1.4 cm 200 / 50 Print Code: E(1)

Learning 3139

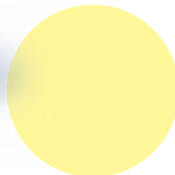

Ice Grippers. 2 Pieces, Adjustable.

12.7 x 1.1 x 5.2 cm 100 / 50
Print Code: N(8)

Graker 4436

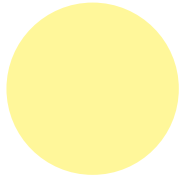

Torch. 3 Leds. 2 Light Modes, Fixed and Flashing. 3 Functions. 3 Batteries AAA Not Included.

7.6 x 13.6 x 6.4 cm 100 / 50
Print Code: E(1)

Moltar 4616

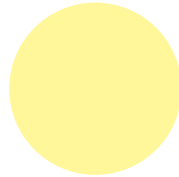

3in1
MULTI-FUNCTION

Ball. Polyester/ PVC. Size: 5.

Consult. 40
Print Code: N(8)

Slinky 6966



Torch. 1 Led. 3 Batteries AAA Not Included.

Ø 3.9 x 10.1 cm 100 / 50
Print Code: E(1)

Fillex 4640

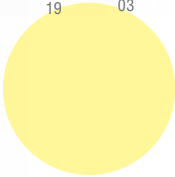

Air Blower.

25 x 8 x 4.5 cm 50 / 25
Print Code: F(1)

Tucco 4500

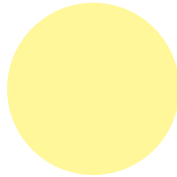

Mat. PE.

45 x 45 cm 100 / 10
Consultar
Print Code:

Misbiz 5127

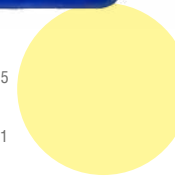

Towel. 100% Cotton 245 g/ m2.

Ø 4.5 cm 300
Print Code: D(1), N(8)

Spica 5292

30 x 30 cm



Bracelet.

Ø 7 x 1.4 cm 500 / 10
Print Code: L1

Energy 3569



Waistbag. Polyester/ Spandex.

22 x 3.5 cm 200 / 10
Print Code: N(8)

Taskin 4866

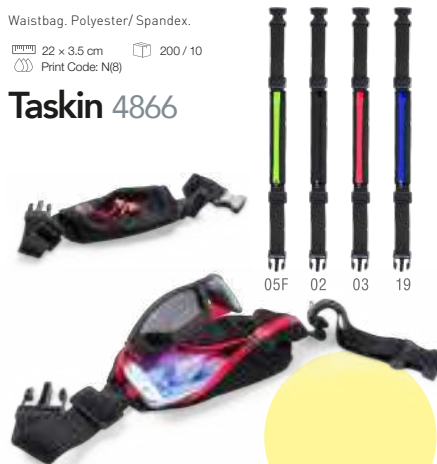

Whistle.

2.8 x 7 x 0.7 cm 1000 / 250
Print Code: C(4)

Forlong 6971



Plug Adapter. USB Output. USA, Europe, Asia, UK, Australia.

▮ 4.8 x 11.1 cm 100 / 50
 ☞ Print Code: D(4)

Tribox 4698

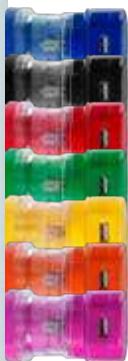

19
02
03
04
05
07
11



01

Passport Holder. PVC.

▮ 10 x 13.8 cm 300 / 25
 ☞ Print Code: E(1)

Klimba 3927



02
03

19

Luggage Tag.

▮ 9.5 x 6 x 0.4 cm 500 / 50
 ☞ Print Code: B(4)

Mufix 5264



03 05 04 19 02

Luggage Tag.

▮ 2.6 x 7.6 cm 500 / 50
 ☞ Print Code: B(4)

Bandel 4278

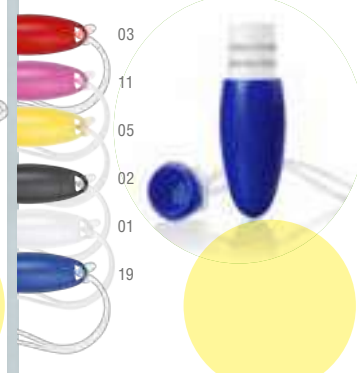

03
11
05
02
01
19

Shoe Polisher.

▮ 6 x 1.8 cm 500 / 50
 ☞ Print Code: C(4), W

County 5642



19



02 01 03

Travel Set. PP. 3 Accessories.

▮ 5.2 x 9 cm 200 / 50
 ☞ Print Code: D(4)

Lopix 6594



35 ml



Pillow. Polyester. EPS Filling.

▮ 9 x 21 cm 50
 ☞ Print Code: D(1)

Sould 4538



02 03 05 11

19

Foldable Bag. Ripstop.

▮ 42 x 32.5 x 17 cm 100 / 10
 ☞ Print Code: F(1), G(1), H(1)

Sofet 4593



05
19
11

03

Trolley. ABS. USB Connection. Rigid. 8 Rotating Wheels. TSA Combination Lock.

▮ 37.5 x 57 x 23 cm 1
 ☞ Print Code: J(1), L2

Silmour 6016



DOCUMENT & POWERBANK COMPARTMENT

SHOPPING BAG HOLDER

MOBILE & TABLET HOLDER

Aromatic Diffuser. Glass/Wood. Lavender Aroma.
40 ml.
Ø 5 x 22 cm 50 / 25 Print Code: E(1), L1

Hestel 1024



40 ml

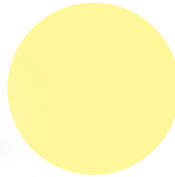

Aromatic Candle. Glass.
Ø 5.6 x 6.7 cm 50 Print Code: E(1), L1

Nettax 5828

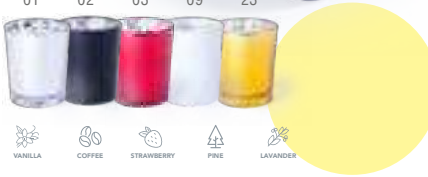
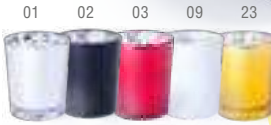

Aromatic Candle. Glass.
Ø 5 x 6.3 cm 100 / 50 Print Code: F(1), L1

Persy 6485

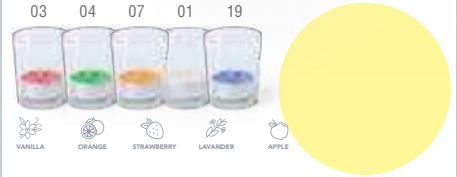

Message Board. Led Lights. 3 Felt Tip Pens and Erasers Included. 3 Batteries AAA Not Included.
15 x 11 x 3.5 cm 50 / 25 Print Code: D(1)

Nathan 5573



Message Hanger. Led Lights. Felt Tip Pen and Eraser Included. 3 Batteries AAA Not Included.
8.3 x 22.3 x 2.7 cm 100 / 50 Print Code: D(1)

Katrin 6317



Holder. Padded.
39 x 30 x 4 cm 10 Print Code: G(1)

Ryper 3665



19

03

02



Humidifier. Led Lights. 250 ml. 1 Steam Mode. USB Connection.
Ø 5 x 18 cm 50 Print Code: E(1), L2

Paffil 6265



19

03

01

250 ml



Coin Tray. PVC.
12 x 12 x 4 cm 300 / 50 Print Code: F(1)

Flot 3430

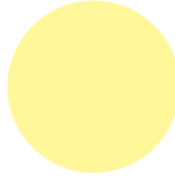
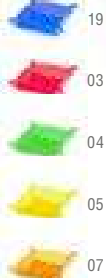

Wall Clock. Button Battery Included.
Ø 8.8 x 2.5 cm 100 Print Code: F(1)

Yatax 4291



01

03

19

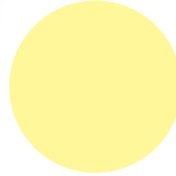

Wall Clock Timer. 1 Battery AA Not Included.
17.8 x 24.7 x 4.4 cm 20 Print Code: F(1)

Tekel 4290



03

19

05

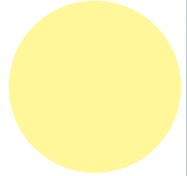

Knife, Stainless Steel.

3 x 20.5 x 1.5 cm 300 / 100
Print Code: D(1)

Kai 4003



01 03

19



Knife Peeler Set, Ceramic.

2.6 x 18.6 x 1.9 cm 200 / 50
Print Code: D(4)

Levian 5273



01 19

16

03



Kitchen Tongs.

3 x 16.3 x 0.7 cm 500
Print Code: E(4)

Karel 2486



19

04

01

03



Vaporizer.

Ø 2.5 x 9.3 cm 1000 / 50
Print Code: C(4)

Jandres 4273



118



119

125



Opener, Magnetic.

12.6 x 1.6 x 8 cm 300 / 50
Print Code: D(1)

Victus 5651



Dispenser Clip, PP.

14.3 x 4.5 x 6.5 cm 200 / 50 Print Code: D(4), W

Dacix 6593

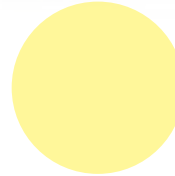

Mold, Silicone.

Ø 10.5 x 2 cm 300 / 10
Print Code: E(1)

Baldix 5496



03

04



Mold Set, 2 Pieces.

12.2 x 12 x 5.7 cm 60
Print Code: D(1)

Thade 4145

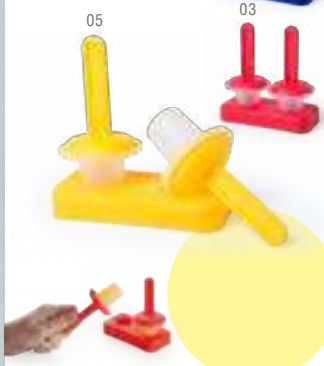

19

03

05



Multipurpose Hook, PET, Adhesive, Reusable.

8 x 9 cm 1000 / 50
Print Code: C(1)

Rucco 4098

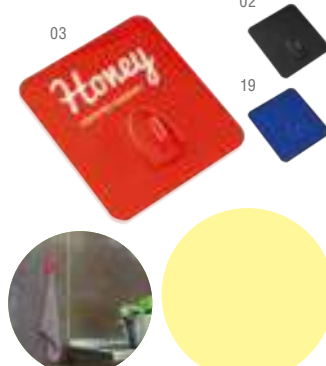

01

02

19

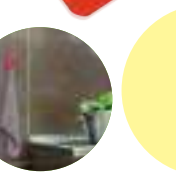

Coaster, Felt.

10 x 10 x 0.6 cm 1000 / 100
Print Code: E(1), N(8)

Tanzak 4701



02

04

05

11

03

19

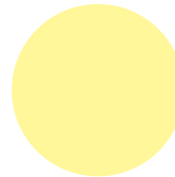

Pestle and Mortar. Bamboo.

Ø 12.6 × 10.8 cm 20 Print Code: F(1), L1

Rubron 1244



Sushi Set. Bamboo. 5 Pieces. Cotton Pouch.

13 × 29 × 3.5 cm 50 Print Code: F(1), L2, N(6)

Kazary 1400



Spoon. Coconut.

6 × 30 × 0.9 cm 200 / 50 Print Code: C(1), L1

Yoana 1066

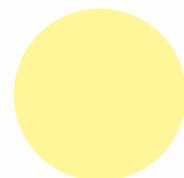

Serving Dishes. PP.

Ø 25.5 × 2 cm 100 19 01 03 07

Zeka 4146



Serving Dishes. Ceramic.

Ø 8.8 × 3.4 cm 60 / 20 02 03

Boletus 3444



Chopsticks Set. Bamboo. 2 Pieces.

22.5 cm 1000 / 100 02 03 19

Orient 3368

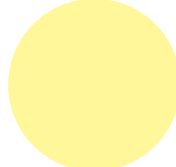
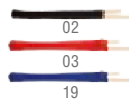

Chopsticks Set. Coconut. 2 Pieces.

22.5 cm 500 / 50

Dunay 1065



Cheese Knife Set. Wood/ Stainless Steel. 4 Pieces.

19 × 2.3 × 16 cm 40 / 10

Koet 3440



Cheese Knife Set. Wood/ Stainless Steel/ PP. 5 Pieces.

13 × 15 × 5.6 cm 30

Roldic 5561



Place Mat. Silicone.

17.3 × 17.3 × 0.4 cm 300 / 100

Soltex 4565

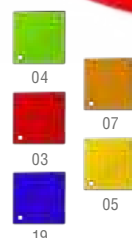

Place Mat. Felt.

40 × 30 × 0.3 cm 150 / 10

Yenka 4132

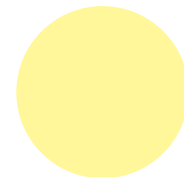
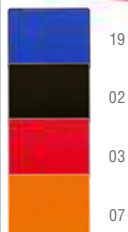

Magnet. PVC.
 Ø 5.5 cm 1000 / 50
 Print Code: D(4)

Fico 3227

19



01
03
05



Magnet.
 6 x 6 cm 2000 / 1000
 Print Code: C(4), W

Daken 4514



11
07
05
04
03
02
01
19







Magnet Photo Frame. Photos Size: 9 x 13 cm.
 11.5 x 16.5 cm 300 / 50
 Print Code: D(4)

Magneto 3213

19

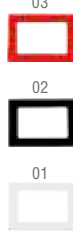
03
02
01

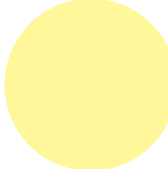







Magnet.
 6 x 4 cm 2000 / 1000
 Print Code: C(4), W

Kisto 4515



01
02
03
04
05
07
19

Place Mat. 100% Cotton.
 40 x 30 x 0.2 cm 400 / 10
 Print Code: E(1), N(8)

Irsan 3223

19



18
02
01
03





Magnet. 40 Sheets Notepad.
 6 x 14.6 cm 400 / 100
 Print Code: C(2)

Sylox 4811

11
07
05
04
03
02
01
19





Kitchen Mitten. 100% Cotton.
 19.5 x 31 cm 200 / 50
 Print Code: F(1), N(8)

Calcis 4536

07





Pot Holder. Polyester/ Neoprene. One Flat Side for Printing.
 17.5 x 21 cm 200 / 50
 Print Code: E(1), N(8)

Hisa 4535

03
07



02



Apron. Non-Woven.
 50 x 73 cm 200 / 50
 Print Code: F(1)

Chef 9288

21

13
02
03
07



Foldable Apron. Non-Woven.
 50 x 73 cm 200 / 10
 Print Code: F(1), G(1), H(1)

Sopex 4169

19

07
02
03
04





Tongs.

2.4 x 15.5 x 3.5 cm 100
 Print Code: C(4)

Kubits 2514

Cocktail Set. PS. 60 ml. 5 Accessories.

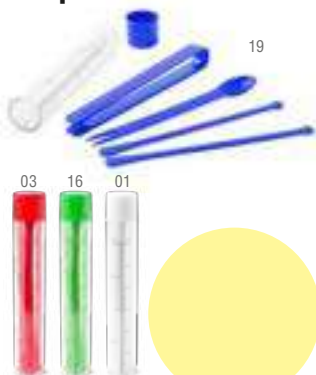
Ø 3 x 17 cm 200 / 50
 Print Code: D(1)

Kaipir 4696

Drink Stirrer. PS.

2.8 x 25.5 x 1.7 cm 800 / 100
 Print Code: B(1), V

Charax 2513

Opener. Aluminium. Magnetic.

3.8 x 8.5 x 0.3 cm 1000 / 100
 Print Code: D(4), L1

Anubix 1119

Ice Bucket Speaker. Multicolour Smart Leds. Bluetooth Connection. Sound Power 5W. Battery 1200 mAh.

24.5 x 29 x 23.5 cm 4
 Print Code: I(1)

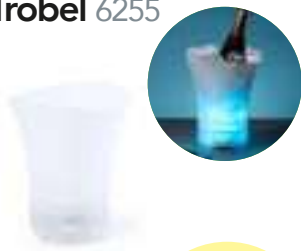
Trobel 6255

Wine Rack. PU.

41 x 31 x 21 cm 30
 Print Code: E(1), L1

Conde 9554

Bottle Cooler. AS.

Ø 11.5 x 23.5 cm 12
 Print Code: F(1)

Pusko 3833

Vacuum Bottle Stopper. Metal/ ABS.

4.5 x 7.5 x 3.5 cm 200 / 50
 Print Code: D(1), L1

Brenix 6997

Hat. TC. 35% Cotton/ 65% Polyester. Adjustable.

Consult. 300 / 50
 Print Code: E(1), N(8)

Painer 5286

Apron. 100% Polyester.

90 x 90 cm 60 / 10
 Print Code: G(1), N(8), P

Bremor 4871

Apron. 100% Polyester.

54 x 73 cm 50
 Print Code: G(1), N(8), P

Javess 5029

Opener Coaster.

8.2 x 8.2 x 0.4 cm 500 / 100
 Print Code: D(4), W

Olmux 5652

Earrings. PU Pouch.

Consult. 200 / 12 Print Code: Consultar

Drems 7327

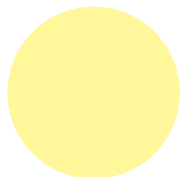

Adjustable Ring. PU Pouch.

Consult. 200 Print Code: Consultar

Tegux 7266

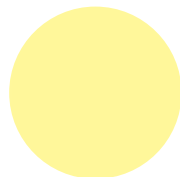

Earrings. PU Pouch.

1.8 x 2.2 cm Consult. 200 / 20 Print Code: Consultar

Moss 7185



Adjustable Ring. PU Pouch.

Consult. 200 / 20 Print Code: Consultar

Zook 7313



Adjustable Ring. PU Pouch.

Consult. 200 / 20 Print Code: E(1)

Hansok 7314

■■■ ANTONIO MIRO ■■■



Adjustable Ring. PU Pouch.

Consult. 200 / 20 Print Code: E(1)

Helant 7312

■■■ ANTONIO MIRO ■■■

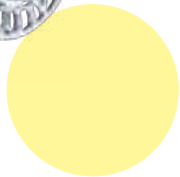

Adjustable Ring. PU Pouch.

Consult. 200 / 20 Print Code: Consultar

Plus 7188

■■■ ANTONIO MIRO ■■■

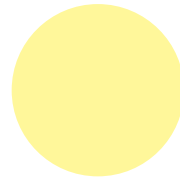

Bracelet.
 20.5 x 2.6 cm 1000 / 50
 Print Code: E(1)

Many 7032



Scarf. Cotton/Viscose.
 160 x 21 cm 40
 Print Code: N(8), P

Luomo 9804



Alexluca
Italy

Towel Pareo. 100% Cotton 110 g/m2. Cotton Pouch.
 180 x 70 cm 50
 Print Code: F(1), G(1), N(8)

Yanex 6056



180 x 70 cm
110 g/m²

Scarf. Cotton/ Polyester.
 180 x 50 cm 200 / 10
 Print Code: F(1), N(8)

Mirtox 4830



Bracelet.
 Ø 6 x 0.8 cm 2000 / 100
 Print Code: D(1)

Hirion 4336



Bracelet. Polyester. Adjustable.
 Ø 8 x 1.1 cm 2000 / 200
 Print Code: E(1)

Mitjansi 4123



Bracelet. PU/ Polyester. Adjustable.
 Ø 8 x 1.2 cm 2000 / 10
 Print Code: N(8)

Quilex 5480



Bracelet. PVC. Adjustable.
 21.5 x 0.8 cm 3000 / 500
 Print Code: Consultar

Tonis 4399



Belt. Silicone.
 117 x 3.3 x 0.3 cm 100 / 10
 Print Code: E(1)

Kyiss 4594



Braces. Polyester. One Size. Adult.
 11 x 31 x 0.9 cm 100 / 10
 Print Code: E(1), L1

Corkey 5136



Keyring Coin. 2.8 x 5.1 x 0.4 cm 1000 / 100 Print Code: C(4)

Zabax 4669

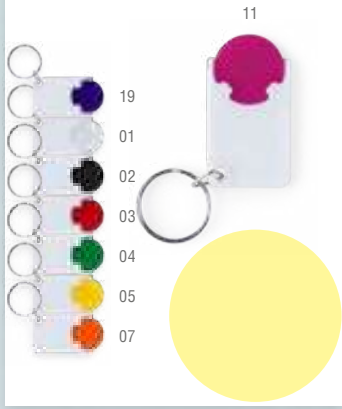

Keyring Coin. 2.8 x 5.1 x 0.4 cm 1000 / 100 Print Code: C(4)

Beka 3771

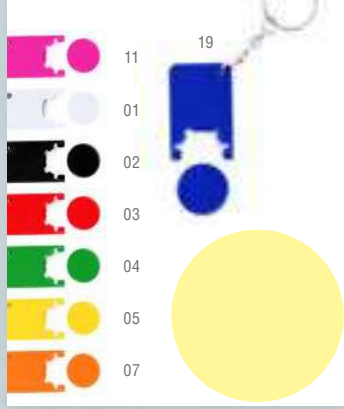

Keyring. Metal. 2 x 5.5 x 0.5 cm 500 / 50 Print Code: L1, V

Harper 4443

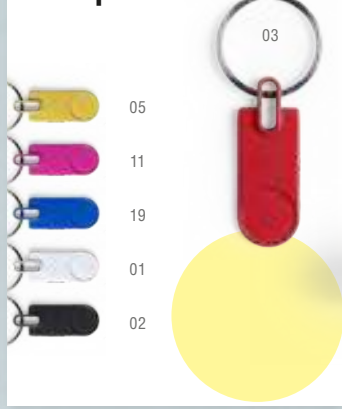

Antibacterial Keyring Coin. 4.1 x 5.2 x 1.1 cm 1000 / 100 Print Code: C(4), W

Portis 6684



Keyring. Metal/ Silicone. Ø 2 x 3.2 cm 400 / 50 Print Code: D(1), L1

Doggo 5653



Keyring. Metal/ Silicone. 4 x 2 x 1 cm 400 / 50 Print Code: D(1), L1

Rizet 4611

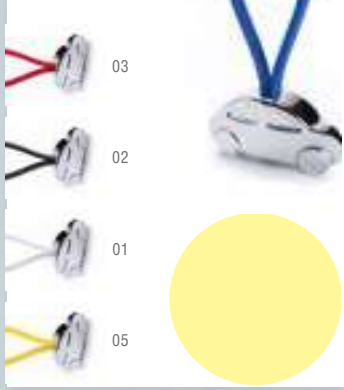

Keyring Coin. Metal/ Silicone. Ø 5.2 x 11.5 cm 400 / 50 Print Code: D(1), L1

Coltax 4704

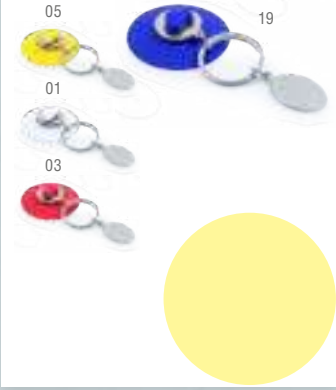

Keyring Coin. Metal/ Silicone. Ø 5.2 x 11.5 cm 400 / 50 Print Code: D(1), L1

Halman 4703

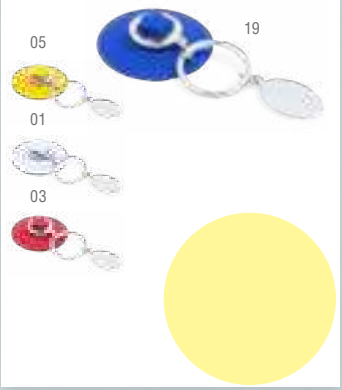

Keyring. 4 x 6.2 x 0.3 cm 1000 / 100 Print Code: C(1)

Timpax 6068

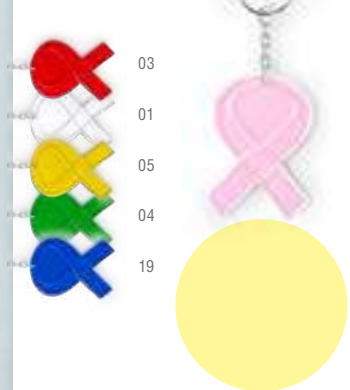

Keyring. Aluminium/ Polyester. 2.7 x 6.8 x 0.6 cm 200 / 50 Print Code: D(4), L1

Slayter 6062



Keyring. Metal. 2.7 x 3 x 2.9 cm 200 / 50 Print Code: D(1), L1

Nazir 4609



Keyring. Metal/ Silicone. 2.8 x 2.7 x 1 cm 400 / 50 Print Code: D(1), L1

Bolky 4610



Keyring. Bamboo.

Consult. 1600 / 400
Print Code: C(4), L1

Tadiok 2617



A - Ø 4,5 X 0,3 CM,

Made in Europe



C - 3,5 X 5,3 X 0,3 CM

Keyring. Wood.

Ø 4.5 × 0.3 cm 500 / 100
Print Code: D(4), L1

Ciran 2687



Made in Europe

Keyring. Wood.

3.3 × 5.6 × 0.3 cm 400 / 100
Print Code: D(4), L1

Ruhen 2686



Made in Europe

Holder. Wood.

6.6 × 11.5 × 8.1 cm 200 / 50
Print Code: D(4), L1, W

Nakin 2681

Made in Europe



Photo Frame Holder. Wood. Photos Size: 5.5 × 7.7 cm.

7.4 × 15 × 9.3 cm 100 / 50
Print Code: D(4), L1, W

Vappe 2682

Made in Europe



Keyring. Wood.

2.9 × 7.1 × 0.6 cm 500 / 100
Print Code: D(4), L1

Trency 2685

Made in Europe



Keyring. Wood.

3.5 × 6.9 × 0.6 cm 400 / 100
Print Code: D(4), L1

Cadon 2684

Made in Europe



Keyring. Led Lights. 75 Pieces. Button Battery Included.

2.8 × 5 × 1.4 cm 500 / 100 Print Code: C(1)

Kadilar 5990



02

01

Keyring. Metal.

2.2 × 5.5 × 0.4 cm 200 / 50 Print Code: D(1), L1

Depor 4981



306

305

298

302

303

304

Keyring. Metal.

3.6 × 3.6 × 0.5 cm 400 / 50 Print Code: D(1), L1

Inmo 9271



Keyring Anticontact. Stainless Steel.

3.2 x 7.6 x 0.1 cm 400 / 200
Print Code: D(1), L1

Bigox 6644

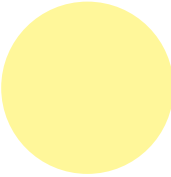

Keyring Anticontact. Aluminium.

5.1 x 7.8 x 0.5 cm 800 / 200
Print Code: D(4), L1

Kozko 6658

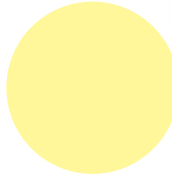

Antibacterial Keyring Anticontact.

3 x 10 x 0.5 cm 1000 / 200
Print Code: C(4)

Riken 6662

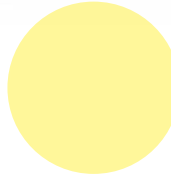

Keyring Anticontact.

3.1 x 7.2 x 0.4 cm 2000 / 1000
Print Code: C(4)

Napil 6690

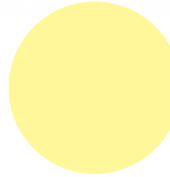

Speaker Keyring.

2.8 x 6.3 x 2.8 cm 500 / 50
Print Code: C(4), W

Holys 4636



19



03



Keyring. PVC/ Aluminium. Reflective.

3.2 x 28 cm 300 / 50
Print Code: D(1)

Brux 4530

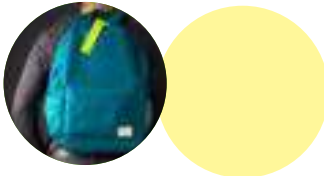

Antistress Keyring. TPR.

6.9 x 11 x 1.7 cm 200 / 50
Print Code: E(1), L1

Mandery 5657



19



Pouch. Soft Shell. Adaptable.

6.8 x 11.4 x 0.5 cm 1000 / 100
Print Code: D(1), N(8)

Karlux 6762



19

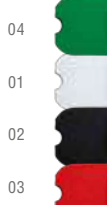

Keyring. Felt.

5.5 x 0.3 cm 2000 / 50
Print Code: N(8)

Nicles 4131

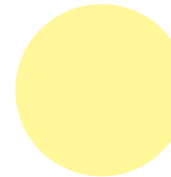
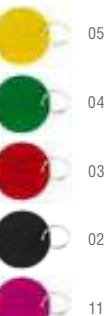

Stylus Touch Pen.

3.4 x 11.6 cm 1000 / 50
Print Code: C(1)

Hability 4327

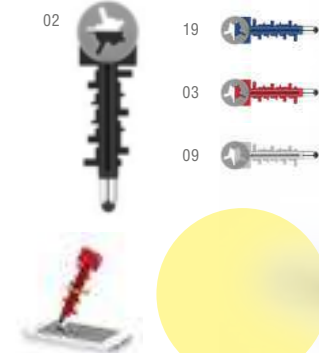

02

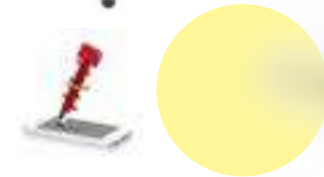

Cigarette Pack Cover. Cardboard.

5.8 x 9 x 2.3 cm 2000 / 100
Print Code: A(4)

Straik 5412



319 318 316

317

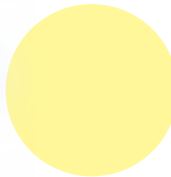

Filling Machine.

12.4 x 4.1 x 3.2 cm 200 / 50
Print Code: D(4)

Morris 4785



19

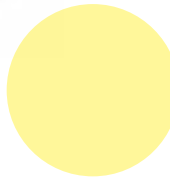

Card Holder. PVC. 1 Compartment.

6.6 x 9.5 x 0.1 cm 5000 / 100
Print Code: C(1)

Kazak 4224

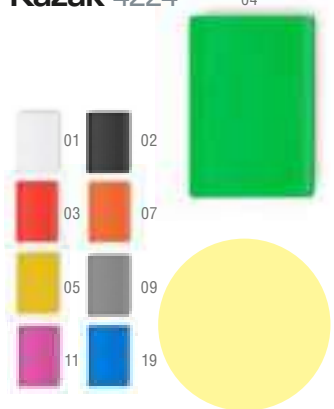

Card Holder. PVC. 6 Compartments.

7.5 x 10.3 x 0.4 cm 1000 / 50
Print Code: C(1)

Mitux 4226



Wallet. PU.

8.5 x 10.5 x 2 cm 300 / 50
Print Code: E(1), L1

Lanto 4367



Card Holder. PU. 10 Compartments.

8 x 10.7 x 1 cm 200 / 100
Print Code: D(1)

Midel 4571



Holder. ABS/Silicone. Adhesive. 1 Compartment.

8.8 x 5.6 x 0.5 cm 500 / 100
Print Code: D(4)

Tisson 6305



Purse. PVC. With Inner Lining.

10 x 8 x 1.8 cm 500 / 10
Print Code: D(1)

Zirplan 5243



Purse. PVC. With Inner Lining.

17 x 11 x 2 cm 200 / 10
Print Code: D(1)

Becky 7014



Purse. PU.

Ø 12 cm 300 / 10
Print Code: D(1)

Kumba 5501



Bag Hanger Key Finder. Metal/ PU.

Ø 2.7 x 7.5 cm 200 / 50
Print Code: D(4), L1

Lysia 4526



Colouring Book. 48 Sheets. 96 Designs.

15 x 15 x 0.7 cm 100 / 50
Print Code: C(2)

Rudex 5564



Purse Holder. Lycra. Padded.

13.5 x 7 x 1.4 cm 500 / 100
Print Code: N(8)

Donic 5804



Hydroalcoholic Gel. 240 ml. Skin cleansing solution.
 6.8 x 15.5 x 4.3 cm 40 Print Code: D(1)

Tassi 6637



240 ml

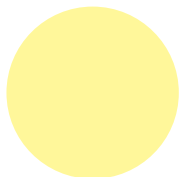

Automatic Dispenser. 45 ml. Battery 1.800 mAh.
 5.5 x 9 x 7.5 cm 50 Print Code: E(4), W

Bisnal 6698

WITH MOTION SENSOR / CON SENSOR DE MOVIMIENTO

45 ml



Ozone Generator. Battery 1800 mAh.
 11.5 x 4.3 x 11.5 cm 30 Print Code: F(4)

Trick 6653

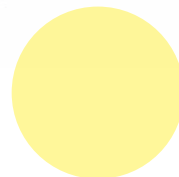

UV Sterilizer Lamp. Ultraviolet Light. Battery 400 mAh.
 3 x 12.5 x 1.4 cm 100 / 50 Print Code: E(4), W

Nurek 6654



UV Sterilizer Lamp. Ultraviolet Light. 2 Batteries AAA Not Included.
 3.1 x 17.5 x 3.1 cm 200 / 100 Print Code: E(4)

Klas 6649



Charger UV Sterilizer Lamp. Wireless 10W. USB Output. Ultraviolet Light. USB Connection.
 11 x 12 x 11 cm 30 Print Code: F(2)

Blay 6671



Charger UV Sterilizer Box. Wireless 5W. Ultraviolet Light. USB Connection.
 20.5 x 4.5 x 12.5 cm 30 Print Code: F(2), W

Halby 6670

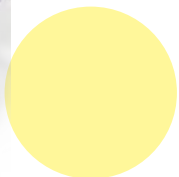

Charger UV Sterilizer Box. Bamboo/ABS. Wireless 5W. Ultraviolet Light. USB Connection.
 20.5 x 4.5 x 12.5 cm 30 Print Code: F(2), L2, W

Strey 6889



UV Meter.
 20.2 x 4 cm 2000 / 200 Print Code: D(4)

Rado 3599

07
01
02
03

19

Back Support Belt.
 98 x 18 cm 100 Print Code: F(1), N(8)

Visser 4807

03
02

19

Thermal Bag. 400 ml. Cold and Warm. Reusable.
 14 x 3 cm 200 / 50 Print Code: E(1)

Liman 4302

400 ml

02

Clip Memo Holder. Polyresin.
 3.5 x 11 x 3 cm 500 / 50 Print Code: E(1)

Sanus 3821

A
B

Massager. Metal.
 11 x 22 x 11 cm 50 Print Code: D(1)

Citus 3996

03

19
05
02

Exercise Band.
 72 x 1.2 cm 400 / 50 Print Code: C(1)

Mansat 5820

19

04
03
01

Beauty Bag. PVC.
 19.5 x 10 x 2.5 cm 300 / 10 Print Code: F(1)

Valax 4477

07F
05F
04F
11F

Beauty Bag. PVC. Mirror Included.
 18 x 10 x 2.5 cm 300 / 10 Print Code: F(1)

Xana 3727

01

02
11
04
03

Beauty Bag. PVC.
 29 x 21 x 9 cm 200 / 50 Print Code: F(1)

Losut 4778

02

01
03
19

Beauty Bag. PVC.
 24.5 x 20 x 6 cm 200 / 10 Print Code: F(1)

Bracyn 5933

01
03
04
07
11
19

Grow Pouch. Recycled Paper. Nasturtium Seeds and 6 Crayons Included.

13 x 21 x 5 cm 50
Print Code: D(1)

Halors 2691

Made in Europe



Flowerpot. Ceramic. 10-12 Petunia Seeds Included. Assorted Coloured Flowers.

6 x 11 x 7 cm 100 / 50
Print Code: F(1)

Chupon 5905



Multipurpose Bag. LDPE.

23 x 18 x 6.5 cm 1000 / 100
Print Code: E(1)

Dusky 4876



Skill Game. Wood. 33 Pieces. Non-Woven Pouch.

12.5 x 17 cm 300 / 100
Print Code: F(1), N(8)

Dokym 5717

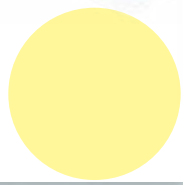

Antibacterial Yoyo.

5 x 1.5 cm 500 / 100
Print Code: C(4), W

Tesam 6678

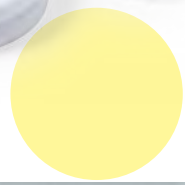

Spinning Top.

3.7 x 3.4 cm 2000 / 1000
Print Code: B(1)

Buddy 4682



- 16
- 01
- 03
- 05
- 21

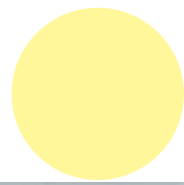

Kids Hat. Polyester.

Consult. 200 / 25
Print Code: E(1)

Tolvex 4838

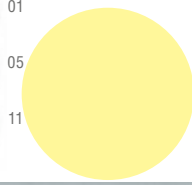

Pai Pal. Wood / Recycled Cardboard.

13 x 28 cm 500 / 100
Print Code: C(1)

Lelex 6631



Selfie Pai Pal.

18 x 27 cm 200 / 20
Print Code: B(1)

Emoty 5406

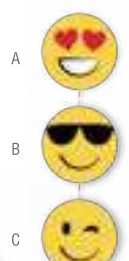

Selfie.

17 x 21 cm 2000 / 200
Print Code: B(1)

Kraliem 5472

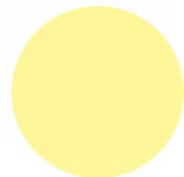

Selfie Set. 5 Pieces.

20 x 25 cm 200 / 20
Print Code: B(1)

Carrey 5471



Banner. Roll Up.
 70 x 26 cm 500 / 250
 Print Code: G(1)

Oé 9566

19

02
03
04
05
07

Pennant Flag. Polyester 210D.
 80 x 30 cm 500 / 10
 Print Code: F(1), R

Portel 6450

03

19
01
04
05
07

Multipurpose Bracelet. Polyester.
 40 x 3 cm 20000 / 1000
 Print Code: D(1), R

Neliam 4313

22
19
04
05
02
03
01

Pin Loop.
 Ø 1.8 cm 5000 / 1000
 Print Code: B(1)

Solidario 9740

02 03 05 01 19 07

04



Tally Counter. Button Battery Included.
 3.4 x 6.2 x 2 cm 200 / 50
 Print Code: C(4)

Dolim 6691

Tally Counter.
 4 x 5.1 x 3.2 cm 200 / 50
 Print Code: C(4)

Yoksy 6705

Lenses. UV400 Protection.
 Consult. 300 / 10
 Print Code: Consult.

Options 5050

01
02
03
04
05
07
11
19

Frame.
 Consult. 300 / 10
 Print Code: D(4)

Options 5049

No Lens Glasses. Polyester Pouch.
 Consult. 400 / 10
 Print Code: D(4)

Martyns 3609

02

22
01
03
19

Glasses.
 Consult. 300 / 10
 Print Code: D(4)

Kathol 4413

04F

11F
05F
07F

Pocket Knife. Stainless Steel. Safety Lock Included.

9 x 1.9 x 1 cm 240 / 12
Print Code: E(1)

Bomber 9579

04

02

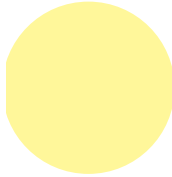

Pocket Knife. Metal/ Stainless Steel. 1 Led. Safety Lock Included. Button Batteries Included.

11.4 x 3 x 1 cm 100 / 10
Print Code: E(1), L1

Damok 7340



orizons
adventure

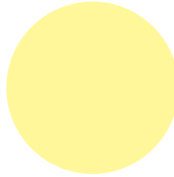

Multitool. 4 Leds. 12 Functions. 3 Piles AAA Non Included.

4.5 x 14 cm 50 / 25
Print Code: E(1), L1

Talos 3687



Pocket Knife. Stainless Steel.

11.2 x 1.5 x 1.4 cm 360 / 10
Print Code: E(4)

Clip 8230

OPENER

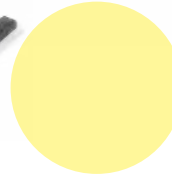

Kneeling Mat. EVA.

16 x 30 x 1.5 cm 100
Print Code: F(1)

Paty 5276

03

04

05

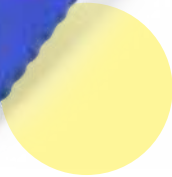

Holder Charger. 2 USB Outputs. 3100 mA.

8.2 x 11 x 9.4 cm 50
Print Code: F(1)

Kerub 5534

2in1
MULTI-FUNCTION

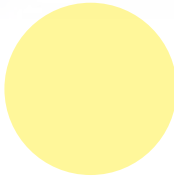

USB Chargers Set. 2 Accessories.

8 x 4.2 x 6.3 cm 200 / 50
Print Code: E(1), F(4)

Canox 4331

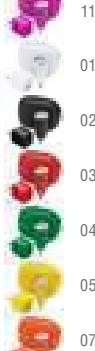

11

01

02

03

04

05

07



19

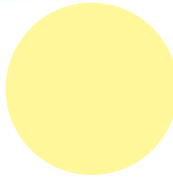

Holder. Adjustable.

18 x 7 x 14 cm 50
Print Code: E(1)

Osorix 5780

12" TABLET COMPARTMENT

19

08

03



Holder. Aluminium. Adhesive and Magnetic.

3.3 x 3 cm 200 / 50
Print Code: F(1), L1

Aragor 5540



Holder. Aluminium. Adhesive and Magnetic.

3.5 x 5 cm 200 / 50
Print Code: F(1), L1

Kruzol 5954



09



19

03

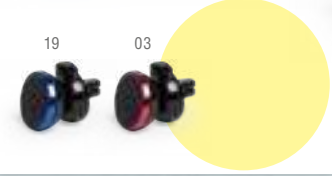

Holder. Metal. Adhesive.

3.2 x 4.8 x 1.2 cm 500 / 100
Print Code: E(1), L1

Atosh 6270

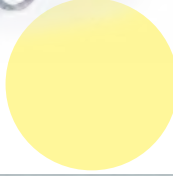

Holder.

3.6 x 5.3 cm 200 / 50
Print Code: F(1)

Glatix 6224



USB Car Charger. 2 USB Outputs. 2100 mA.

2.6 x 8 x 3.7 cm 500 / 50
Print Code: C(4)

Heyon 4211



USB Car Charger. 2 USB Outputs. 2100 mA.

3.2 x 6.2 cm 500 / 50
Print Code: C(4)

Denom 4950



USB Car Charger.

2.3 x 5.6 cm 500 / 50
Print Code: C(4)

Hikal 4210



Earphone Car Charger. Aluminium. Bluetooth Connection. 2 USB Outputs. 2100 mA.

2.1 x 9.7 cm 50
Print Code: E(4), L1

Lacoust 5527



Pouch.

9 x 9 x 2 cm 200 / 50
Print Code: D(4)

Kibal 4761



Gift Box. Cardboard.

6 x 1.2 x 2.5 cm 5000
Print Code: B(4)

Halmer 5083



Pouch. PU.

7 x 3.7 cm 500 / 100
Print Code: D(1)

Shilay 4630

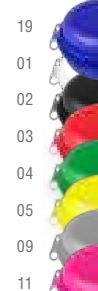

Multipurpose Bag. PP.

14.6 x 14.1 cm 500 / 25
Print Code: C(2)

Liven 2602



Multipurpose Bag. PP.

19 x 1.2 x 10.5 cm 125
Print Code: D(1), W

Kloe 2586



Pouch. 50% Cotton/50% Polyester.

15 x 18 cm 400
Print Code: E(1), N(8)

Claver 2611



Pouch. Non-Woven.

15 x 16 cm 1000 / 100
Print Code: E(1)

Yator 2613



Cap. Microfibre/ Polyester. 5 Panels. Velcro Closure.

Consult. 200 / 50
Print Code: F(1), N(8), O, P, R



Harum 6208



Cap. 60% Recycled Cotton/ 40% Polyester RPET. 5 Panels. Velcro Closure.

Consult. 200 / 50
Print Code: F(1), N(8), O, P

Pickot 1032



Cap. Microfibre/ Polyester. 5 Panels. Plastic Closure.

Consult. 300 / 50
Print Code: F(1), N(8), O, P, R



Karif 5227



Cap. 100% Brushed Cotton. 5 Panels. Velcro Closure.

Consult. 200 / 25
Print Code: F(1), N(8), O, P

Five 3281



Cap. Polyester. 6 Panels. Velcro Closure.

Consult. 200 / 25
Print Code: F(1), N(8), O, P

Bayet 5799



Cap. 100% Cotton. 5 Panels. Velcro Closure.

Consult. 300 / 30
Print Code: F(1), N(8), O, P

Line 8544

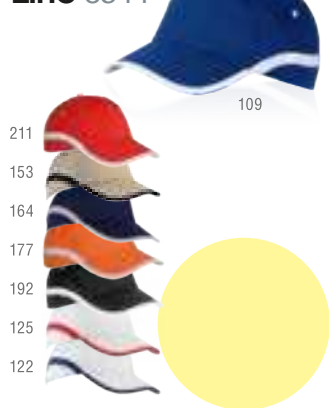

Hat. Cotton/ Polyester.

Consult. 100 / 25
Print Code: F(1), N(8), O, P

Likos 4557



Sun Visor. EVA.

Consult. 1000 / 50
Print Code: E(1), N(8)

Sunday 9705

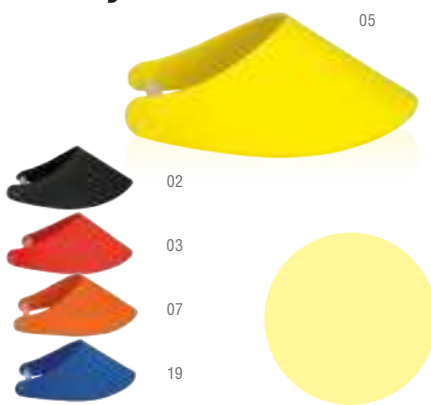

Hat. 100% Cotton.

Consult. 200 / 50
Print Code: F(1), N(8), O, P

Patriot 3123



Hat. Straw.
 Consult. 250
 Print Code: Consultar

Filagarchado 8088

13



INNER BAND VENTILATION



Hat. Paper Straw.
 Consult. 100 / 25
 Print Code: Consultar

Licem 5915



INNER BAND



Hat. Paper Straw. Adjustable.
 Consult. 100 / 25
 Print Code: Consultar

Randolf 1036



ADJUSTABLE INNER BAND



Hat. Paper Straw. Adjustable.
 Consult. 100 / 25
 Print Code: Consultar

Gretel 1037



ADJUSTABLE INNER BAND



Beach Mat. 100% Cotton 125 g/ m2.
 Ø 143 cm 50 / 10
 Print Code: F(1), N(8), O, P

Hansier 5415



03



Towel Pareo. 100% Cotton 110 g/ m2.
 180 x 70 cm 50
 Print Code: F(1), N(8)

Suntan 4885

180 x 70 cm
 110 g/m²





21



Towel Pareo. 50% Cotton/ 50% Polyester 180 g/ m2.
 180 x 90 cm 30 / 5
 Print Code: F(1), N(8), P

Minerva 5721

180 x 90 cm

Hand Fan. Wood/ Cotton.
 42 x 21 cm 250
 Print Code: D(1), E(1), L1

Ventol 7257



HelloKitty



Kaftan. 100% Cotton. One Size. Adult.
 67 x 80 cm 200
 Print Code: F(6), M, N(8), O, R

Roseux 1263



Foulard Pareo. Viscose/ Polyester. Beauty Bag Included.
 180 x 95 cm 50
 Print Code: F(1), N(8), G(1)

Rosix 4831

180 x 95 cm



11



Holder. PVC. Special Folded for Printing.

Ø 17 x 5 cm 200 / 100
Print Code: E(1)

Berton 5615

19



Holder. PVC.

30 x 7 x 18 cm 200 / 100
Print Code: E(1)

Swing 9208

07



Table. PVC.

60 x 7 x 46 cm 100 / 50
Print Code: F(1)

Pelmax 4818

19



Beach Ball. PVC. Deflated Size: 37 cm. Inflated Size: 28 cm.

Consult. 200 / 100
Print Code: F(1), G(1)

Bennick 5618

19

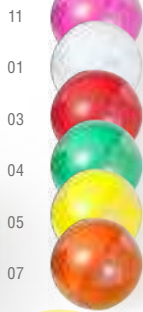

Tube. PVC.

Ø 13 x 86 cm 200 / 100
Print Code: E(1)

Mikey 5114

01

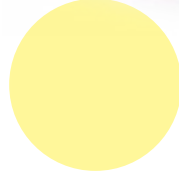

Beach Umbrella. Nylon. PVC Pouch.

Ø 150 cm 12
Print Code: H(1), N(8), R

Mojácar 8448

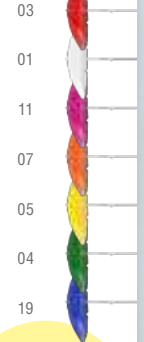

Glasses Strap. Polyester.

58 x 0.5 cm 1000 / 100
Print Code: D(1)

Balian 5623

19

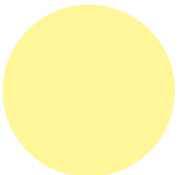

Multipurpose Glasses Strap. Microfibre.

2 x 46 x 1 cm 1000 / 100
Print Code: F(1)

Shenzy 4452

02

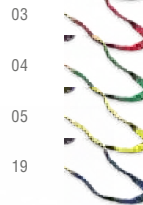

Sunglasses. UV400 Protection.

Consult. 300 / 10 Print Code: D(4)

Saimon 5354

19

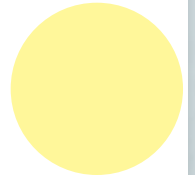
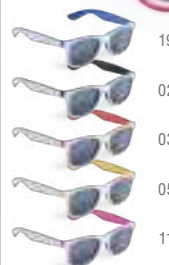

Sunglasses. UV400 Protection.

Consult. 300 / 10 Print Code: D(4)

Lantax 5283



Sunglasses. Mirrored Lenses. UV400 Protection.

Consult. 300 / 10 Print Code: D(4)

Bunner 4214



Sunglasses. Foldable. UV400 Protection.

Consult. 300 / 10 Print Code: D(4)

Stifel 4310



Sunglasses. UV400 Protection.

Consult. 300 / 10 Print Code: D(4)

Musin 5282



Sunglasses. UV400 Protection.

Consult. 300 / 10 Print Code: D(4)

Bella 7001



Sunglasses. UV400 Protection.

Consult. 300 / 10 Print Code: D(4)

Haris 4748



Sunglasses. UV400 Protection.

Consult. 300 / 10 Print Code: D(4)

Tunak 5924



Sunglasses. Metal. Mirrored Lenses. UV400 Protection.

Consult. 300 / 10 Print Code: E(1)

Kindux 4800



Sunglasses. UV400 Protection.

Consult. 300 / 10 Print Code: D(4)

Lyoko 3950



Extendable Umbrella. Pongee 190T. Fibreglass Ribs. 23". Automatic. Windproof.

104 x 118 cm 30 / 10
Print Code: G(1), N(8)

Kolper 6155



02
03
06
19



Keyring Raincoat. LDPE. One Size. Kids. 88 x 63 cm.

Ø 6.4 cm 200 / 25
Print Code: D(4)

Rany 3149



19



05
01
03



Earmuffs. Polar Fleece.

Ø 11 cm 300 / 10
Print Code: N(8), O

Katoy 9348



02



19
03
07

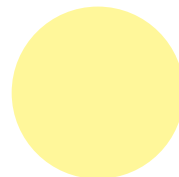

Neck Warmer. Polar Fleece 200 g/ m2. Anti-Pilling.

24.5 x 25.5 cm 100 / 10
Print Code: G(1), N(8), O, P

Nostal 4608



03
02
13
06



Neck Warmer. Polyester/ Polar Fleece 200 g/ m2. Anti-Pilling.

25 x 29 cm 200 / 10
Print Code: G(1), N(8), O, P

Arick 7053



08
02
01

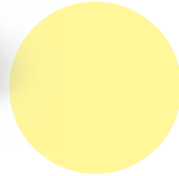

Neck Warmer. Polyester/ Polar Fleece.

25 x 65 cm 200 / 10
Print Code: G(1), N(8), O, P, R

Meifar 5130



121

11
06
04
03
02
19



Hat. Acrylic.

Consult. 250 / 10
Print Code: N(8), O, P

Jive 9781

19

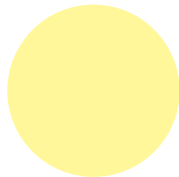

Hat. Polyester. Bluetooth Connection. Battery 55 mAh.

Consult. 100 / 50
Print Code: N(8), P

Seyer 5364





Adult White T-Shirt. 100% Cotton Ring Spun, Single Jersey 150 g/ m2.

☞ S, M, L, XL, XXL 📦 100 / 10
 ☎ Print Code: F(6), N(8), M, O, P

Premium 4482



01



Adult Colour T-Shirt. 100% Cotton Ring Spun, Single Jersey 150 g/ m2.

☞ S, M, L, XL, XXL 📦 100 / 10
 ☎ Print Code: F(6), N(8), O, P

Premium 4481



19

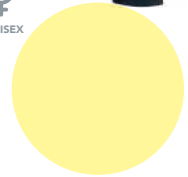

1211
 UNIQUE OFFERS



Kids White T-Shirt. 100% Cotton Ring Spun, Single Jersey 135 g/ m2.

☞ 4-5, 6-8, 10-12 📦 100 / 10 ☎ Print Code: F(6), N(8), M, O, P

Hecom 4200



01



Adult White T-Shirt. 100% Cotton Ring Spun, Single Jersey 135 g/ m2.

☞ S, M, L, XL, XXL 📦 100 / 10
 ☎ Print Code: F(6), N(8), M, O, P

Hecom 4199



01



Kids Colour T-Shirt. 100% Cotton Ring Spun, Single Jersey 135 g/ m2.

☞ 4-5, 6-8, 10-12 📦 100 / 10
 ☎ Print Code: F(6), N(8), O, P

Hecom 4198



19

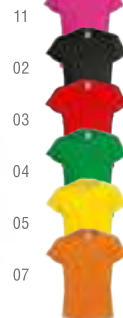

Adult Colour T-Shirt. 100% Cotton Ring Spun, Single Jersey 135 g/ m2.

☞ S, M, L, XL, XXL 📦 100 / 10
 ☎ Print Code: F(6), N(8), O, P

Hecom 4197

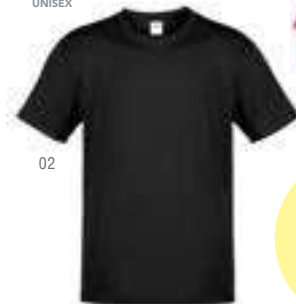

02

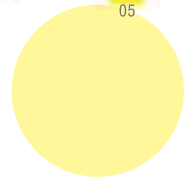

Polo Shirt. 100% Cotton Ring Spun, Pique 180 g/ m2.

S, M, L, XL, XXL 50 / 10
Print Code: F(6), N(8), O, P

Bartel Color
4756



19 03 04 07 06 11 02

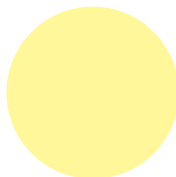

Polo Shirt. 100% Ring Spun Cotton, Pique 180 g/ m2.

S, M, L, XL, XXL 50 / 10
Print Code: F(6), N(8), O, P

Bartel Blanco 4771



01



Women Polo Shirt. Cotton/ Polyester 180 g/ m2.

XS, S, M, L 36
Print Code: F(6), P

65/ 35 3248

19



03



01



02

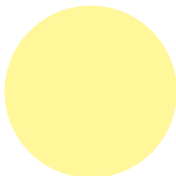

Polo Shirt. 100% Polyester 180 g/ m2. Breathable.

S, M, L, XL 60
Print Code: F(6), N(8), O, P, R

Tecnic Bandera 3578



01



06

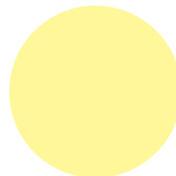

Women T-Shirt. 100% Polyester 135 g/ m2. Breathable.

S, M, L 100 / 10
Print Code: F(6), N(8), M, O, P, R

Tecnic Lemery 4731



11F 05F 01



02

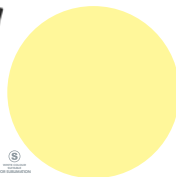

Women T-Shirt. 100% Polyester 130 g/ m2.

S, M, L 100
Print Code: F(6), N(8), M, O, R

Slem 4720



07F 02 05F 01



11F



Shorts. 100% Polyester 170 g/ m2.

S, M, L 100 / 10
Print Code: F(6), N(8), O, P

Bizax 4718



01



05F



11F



Adult T-Shirt. TC. 15% Cotton/ 85% Polyester 160 g/ m2.

S, M, L, XL 50
Print Code: F(6), N(8), M, O, P, R



Yuk 4719



05F

19

01

02

03



Adult T-Shirt. 100% Polyester 135 g/ m2. Breathable.

S, M, L, XL, XXL 100 / 10
Print Code: F(6), N(8), M, O, P, R

Tecnic Sunit 4725



19

- 05
- 01
- 02
- 03



Adult T-Shirt. 100% Polyester 135 g/ m2. Breathable.

S, M, L, XL, XXL 100 / 10
Print Code: F(6), N(8), O, P, R

Tecnic Fleser 4471



05F

- 19
- 02
- 03



Adult T-Shirt. Polyester/ Elastane 135 g/ m2. Breathable.

XS, S, M, L, XL, XXL 80 / 10
Print Code: F(6), M, N(8), O, P, R

Tecnic Layom 6462



19

- 05
- 01
- 02
- 03
- 04



Shorts. 92% Polyester/ 8% Elastane 180 g/ m2. Unisex.

S, M, L, XL, XXL 50
Print Code: F(1), N(8)

Lowis 4913



02



Adult T-Shirt. 100% Polyester 135 g/ m2. Breathable.

S, M, L, XL, XXL 80 / 10
Print Code: F(6), N(8), O, P, R

Tecnic Dynamic Comby 6079



11

- 04
- 02
- 03
- 04
- 07



Adult T-Shirt. 100% Polyester 135 g/ m2. Breathable.

S, M, L, XL, XXL 100 / 10
Print Code: F(6), N(8), M, O, P, R

Tecnic Combi 4473



02

- 03
- 05F
- 04
- 19



Kids T-Shirt. 100% Polyester 120 g/ m2.

4-5, 6-8, 10-12 100 / 10
Print Code: F(6), N(8), M, O, P, R

Kraley 5748



01



Adult T-Shirt. 100% Polyester 120 g/ m2.

S, M, L, XL, XXL 80 / 10
Print Code: F(6), M, N(8), O, P, R

Kraley 5747



01



Adult Technical Sweatshirt. 100% Polyester 265 g/m². S, M, L, XL, XXL 30 Print Code: F(6), M, N(8), O, P, R

Kroby 4722

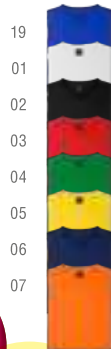

LIGHTWEIGHT & WARM GARMENT
CREASE FREE
WHITE COLOUR SUITABLE FOR SUBLIMATION
UNISEX

Kids Technical Sweatshirt. 100% Polyester 265 g/m². 4-5, 6-8, 10-12 30 Print Code: F(6), N(8), M, O, P, R

Kroby 4769



LIGHTWEIGHT & WARM GARMENT
CREASE FREE
WHITE COLOUR SUITABLE FOR SUBLIMATION
UNISEX

Adult Technical Sweatshirt. 100% Polyester 265 g/m². 4-5, 6-8, 10-12, S, M, L, XL, XXL 30 Print Code: F(6), N(8), M, O, P, R

Theon 4723



LIGHTWEIGHT & WARM GARMENT
CREASE FREE
WHITE COLOUR SUITABLE FOR SUBLIMATION
UNISEX

Kids Technical Sweatshirt. 100% Polyester 265 g/m². 4-5, 6-8, 10-12 30 Print Code: F(6), M, N(8), O, P, R

Theon 4770



LIGHTWEIGHT & WARM GARMENT
CREASE FREE
WHITE COLOUR SUITABLE FOR SUBLIMATION
UNISEX



Jacket. Outside: Soft Shell, 92% Polyester/ 8% Elastane. Inside: 100% Polyester Microfleece. 300 g/ m². Wind and Water Resistant.

S, M, L, XL, XXL 15 Print Code: N(8), P

Baidok 4716



LIGHTWEIGHT & WARM GARMENT
WATER & WIND RESISTANT
UNISEX





Vest. Outside: Soft Shell, 92% Polyester/ 8% Elastane. Inside: 100% Polyester Microfleece. 300 g/ m2. Wind and Water Resistant.

Print Code: N(8), P, R

Persol 6464



LIGHTWEIGHT & WARM GARMENT WATER & WIND RESISTANT UNISEX

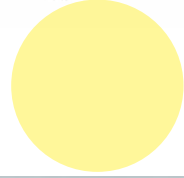

Vest. Outside: Soft Shell, 92% Polyester/ 8% Elastane. Inside: 100% Polyester Microfleece. 300 g/ m2. Wind and Water Resistant.

Print Code: N(8), P

Balmax 4715



LIGHTWEIGHT & WARM GARMENT WATER & WIND RESISTANT UNISEX

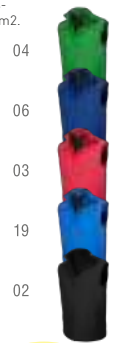

Vest. 35% Cotton/ 65% Polyester.

Print Code: N(8), O, P

Málaga 8664

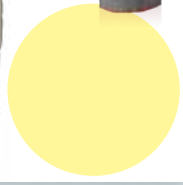
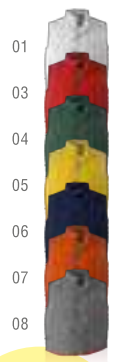

Vest. Nylon/ Polyester.

Print Code: N(8)

Tansy 4717



LIGHTWEIGHT & WARM GARMENT UNISEX

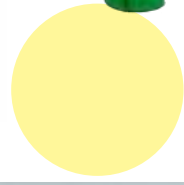

Vest. Polar Fleece 280 g/ m2. Anti-Pilling Treatment.

Print Code: N(8), P

Forest 8662

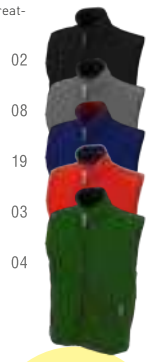

UNISEX



Raincoat. Polyester 210T.

Print Code: G(t)

Natsu 4552

WATER RESISTANT UNISEX

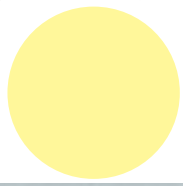
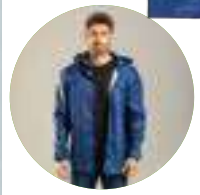

Parka. Outside: Pongee Ripstop. Inside: Polyester/ Polar Fleece. Waterproof Treatment. Inside Zipper for Printing.

Print Code: N(8), P

Zylka 3874



WATER & WIND RESISTANT UNISEX



Jacket. 100% Polyester. Wind and Water Resistant.

Print Code: N(8), P

Luzat 4917



WATER & WIND RESISTANT UNISEX

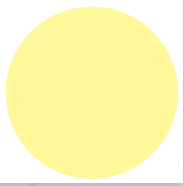

PRINTING TECHNIQUES

DRUKTECHNIEKEN



Pad printing

One of the most widely used branding techniques due to its versatility and efficiency. The logo is transferred to the product by means of a silicone pad adaptable to all sorts of surfaces, obtaining a great definition of the logo even in very small printing areas.

Tampondruk

Een van de meest gebruikte druktechnieken door zijn veelzijdigheid en doeltreffendheid. Het logo wordt op het product aangebracht met behulp van een siliconen tampon die zich aanpast aan alle soorten oppervlakken, waardoor zelfs op zeer kleine markeringsgebieden een grote logodefinitie wordt bereikt.



Silk-screen printing

The most classic of the printing techniques, allowing almost any design to be reproduced on an infinite number of flat materials, with an outstanding, long-lasting result. Particularly suitable for large formats, where several colours can be used to represent the most creative designs.

Zeefdruk

De meest klassieke druktechniek, waarmee vrijwel elk ontwerp kan worden weergegeven op een oneindig aantal vlakke materialen, met een optimaal en duurzaam resultaat. Bijzonder geschikt voor grote afdrucken, met de mogelijkheid om verschillende drukkleuren te gebruiken voor de meest creatieve ontwerpen.



360° Silk-screen printing

Classic screen printing applied to products with cylindrical, conical or curved shapes, with optimal, long-lasting results. Enables 360° designs, with great adhesion to the article.

Circulaire zeefdruk

Klassieke zeefdruk toegepast op artikelen met een cilindrische, conische of gebogen vorm, met een optimaal en duurzaam resultaat. Het maakt 360° ontwerpen mogelijk, met grote hechting aan het artikel.



Screen printing transfer

A step beyond screen printing, which integrates the logo into the product. The printing is applied to a silicone paper which is transferred to the article using a hot plate, resulting in the maximum integration of the design on the surface of the product.

Zeefdruk overdracht

Een verdere evolutie van zeefdruk, waarbij het logo in het product wordt geïntegreerd. De afdruk wordt gemaakt op gesiliconiseerd papier dat vervolgens met een hete plaat op het artikel wordt overgebracht, waardoor een maximale integratie van het ontwerp op het productoppervlak wordt bereikt.



Digital transfer printing

Great for full-colour prints in photo quality. The design is digitally printed onto a vinyl surface applying a type of adhesive that is activated by heat and pressure, with exceptional results.

Transfer Digitaal

Ideaal voor full colour prints van fotokwaliteit. Het ontwerp wordt digitaal afgedrukt op een vinylrugs met een soort lijm die wordt geactiveerd door warmte en druk, met uitstekende resultaten.

Sublimation

One of the most versatile options for full colour designs. The design is first transferred onto a special paper and then to the item (either polyester or 100% polyester treated material) by heat, achieving an excellent full colour finish.

Sublimatie

Een van de meest veelzijdige opties voor kleurontwerpen. Het ontwerp wordt eerst overgebracht op een speciaal papier en vervolgens met hitte op het artikel (op polyester of met 100% polyester behandeld materiaal), wat resulteert in een uitstekende kleurafwerking.



Digital printing

Enables printing of full-colour designs, achieving a quality logo with vivid, photographic colours. The customisation is applied directly on the product and a special printer is required. The surface to be printed must be smooth and regular.

Digitaal afdrukken

Er kunnen ontwerpen in volledige kleuren worden afgedrukt, wat resulteert in levendige kleuren van fotokwaliteit. Maatwerk wordt rechtstreeks op het artikel aangebracht en vereist een speciale printer. Het te bedrukken oppervlak moet glad en effen zijn.



360° Digital printing

Implements traditional digital printing, and can be effectively applied to curved, conical and cylindrical surfaces. The results are especially good on full colour designs.

360° digitale druk

Het is de uitvoering van traditioneel digitaal drukken en kan doeltreffend worden toegepast op gebogen, conische en cilindrische oppervlakken. De resultaten zijn bijzonder bevredigend voor afdrukken in kleur.



Embroidery

Personalisation technique using needle and thread stitches on woven items, very popular on textile garments, caps and bags. The results in terms of colour and customisation quality are excellent.

Borduurwerk

Een personaliseringstechniek waarbij gebruik wordt gemaakt van naald- en draadsteken op textielartikelen, zeer populair op kleding, petten en tassen. De kleurresultaten en de kwaliteit van het maatwerk zijn uitstekend.

Laser printing

This branding technique removes thin layers of material until the design is visible. Distinguished by its durability, simplicity, and the variety of finishes depending on the type of product, obtaining at the same time an elegant and permanent result.

Laser

Deze druktechniek bestaat uit het verwijderen van dunne lagen materiaal totdat het ontwerp zichtbaar wordt. Zij wordt gekenmerkt door haar duurzaamheid, eenvoud en verschillende soorten afwerking afhankelijk van het product, met als resultaat een elegant en permanent resultaat.



360° Laser printing

The solution for cylindrical and conical items, without being limited by the curved surface of the product. Like traditional laser, it stands out for its durability, elegance and the different types of finish depending on the product.

360° laser

De oplossing voor het bedrukken van cilindrische en conische voorwerpen... zonder beperkingen door het gebogen oppervlak van het product. Net als de traditionele laser onderscheidt hij zich door zijn duurzaamheid, elegantie en verschillende soorten afwerking, afhankelijk van het product.

Hot stamping

A thermal transfer printing method in which the personalisation is obtained by applying the adequate temperature and pressure on the item. Recommended for flexible materials such as leather or synthetic leather, easily shaped by heat.

thermo-gravure

Thermische transferdruk waarbij maatwerk wordt bereikt door de juiste temperatuur en druk op het voorwerp uit te oefenen. Het wordt aanbevolen voor flexibele materialen zoals leer of kunstleer, die gemakkelijk door warmte kunnen worden gevormd.



Doming / Epoxy

A technique that involves the printing of the design on an adhesive label, then adding a layer of resin. This layer creates an extraordinary transparency and a tridimensional effect, while adding gloss and protecting the logo. Recommended for full colour logos.

Doming / Harsdruppel

Bij deze techniek wordt het ontwerp gedrukt op een zelfklevend etiket waaraan vervolgens een laag hars wordt toegevoegd. Deze harslaag geeft de afdruk een buitengewone transparantie en een driedimensionaal effect, waardoor glans wordt toegevoegd en het logo wordt beschermd. Aanbevolen voor full colour afdrukken.

REF.	PAG.	REF.	PAG.	REF.	PAG.	REF.	PAG.	REF.	PAG.	REF.	PAG.	REF.	PAG.	REF.	PAG.
1011	1031	1162	813	1302	1119	1438	69, 130	1572	550	1702	347	1833	281	1966	34
1012	838	1163	313	1303	1127	1439	69, 130	1573	536	1703	609	1834	408	1967	19
1014	719	1164	962	1304	1127	1440	76, 849	1574	528	1704	349, 609	1835	245	1968	68, 131
1015	614	1165	416	1305	1128	1441	517	1575	525	1705	610, 653	1836	248	1969	29
1016	614	1166	416	1306	1128	1442	1025	1576	526	1706	610, 653	1837	249	1970	68
1017	935	1167	767	1307	97	1443	245	1577	527	1707	611, 664	1838	108, 257, 994	1971	81
1018	134	1168	768	1308	97	1444	249	1578	868	1708	604, 643	1839	159, 257	1972	75
1020	944	1169	768	1309	1061	1445	235	1579	869	1709	607	1840	235	1973	82
1021	730	1170	776	1310	1061	1446	231, 570	1580	449, 869	1710	578	1843	223	1974	31
1022	730	1171	966	1311	1062	1447	223	1581	489, 869	1711	617	1844	214	1975	75
1023	730	1172	407	1312	1062	1448	162	1582	878	1712	597	1845	214	1976	82
1024	1193	1173	403	1313	1061	1449	149	1583	413	1713	397	1846	241	1977	101
1025	615, 725	1174	403	1314	1059	1450	162	1584	880	1714	624, 645	1847	220	1978	16
1026	720	1175	402	1315	1059	1451	1065	1585	880	1715	627, 645	1848	502	1979	16
1027	731	1176	399	1316	1104	1452	1064	1586	880	1716	621	1849	151	1980	16
1028	680	1177	1065	1317	1104	1454	655	1587	879	1717	621	1850	158	1981	101
1029	937	1178	1064	1318	1106	1455	447	1588	880	1718	763	1851	149	1982	75
1030	937	1179	1064	1319	1106	1456	648	1589	880	1719	389, 825	1852	140	1983	19
1031	938	1180	857	1320	1105	1457	648	1590	880	1720	389, 825	1853	149	1984	34
1032	1210	1181	953	1321	1105	1458	335, 640	1591	875	1721	389	1854	150	1985	77
1033	904	1182	953	1322	1123	1459	334, 640	1592	535, 875	1722	382	1855	147	1986	90
1034	926	1183	950	1323	1107	1460	659	1593	98, 462	1723	382	1856	147	1987	77
1036	1211	1184	951	1324	1104	1461	22	1594	858	1724	382	1857	288	1988	43
1038	923	1185	858	1325	1105	1462	119	1595	858	1725	372	1858	288	1989	82
1039	923	1186	858	1326	1106	1463	678	1596	858, 1055	1726	815, 930, 995	1859	288	1990	81
1040	217	1190	702	1327	1106	1464	101	1597	966	1727	482	1860	288	1991	75
1041	244	1191	702	1328	1105	1465	124	1598	966	1728	766	1861	959	1992	92
1042	235, 523	1192	34	1329	1105	1466	124	1599	709, 948	1729	549	1862	855	1993	81
1043	235, 523	1193	14	1330	1123	1467	153	1600	709, 948	1730	943, 377, 545	1863	152	1994	20
1044	160	1194	14	1331	1107	1468	148	1601	931	1731	640, 550	1864	107	1995	11
1045	276	1195	14	1332	1103	1469	66	1602	943	1732	385	1865	263	1996	45
1046	329	1196	14	1333	1103	1470	218	1603	936	1733	385	1866	128	1997	37
1047	330	1197	14	1334	1122	1471	165, 226	1604	941	1734	393	1867	143	1998	29
1048	351	1198	100	1335	1122	1472	217	1605	938	1735	386	1868	131	1999	39
1050	283	1201	47	1337	373	1473	596	1606	932	1736	386	1869	90	2008	926
1051	283	1202	102	1338	373	1474	597	1607	935, 1055	1737	349	1870	127	2009	895
1053	301	1203	105	1339	594	1475	720	1608	958	1738	375	1871	127	2101	170
1054	652	1204	104	1340	594	1476	274	1609	115, 958	1739	372	1872	580	2233	662
1055	282	1205	50	1341	203, 691	1477	761	1610	108, 514, 949	1740	375	1873	70, 144	2283	170
1056	274	1206	73	1342	736, 807	1478	54, 1017	1611	958	1741	379	1874	137	2308	106
1057	274	1207	727	1343	713, 866	1479	374	1612	975	1742	379	1875	135	2309	106
1058	275	1208	68	1344	380	1480	34	1613	936	1743	374	1876	135	2320	169
1059	307	1210	629, 755	1345	53	1481	36, 502	1614	98, 462	1744	376	1877	135	2321	169
1060	289	1212	715	1346	222	1482	377	1615	649	1746	41	1878	136, 210	2420	154
1061	278	1213	866	1347	230	1483	737, 806	1616	663	1747	23	1879	115	2421	134
1062	765	1215	876	1348	658	1484	456	1617	1018	1748	787	1880	137	2422	1179
1063	382	1216	348, 606	1349	649	1485	456	1618	866	1749	643	1881	138	2423	948
1065	1195	1217	529	1350	47	1487	180	1619	854	1750	612	1882	136	2424	488
1066	1195	1218	526	1351	47	1488	1180	1620	256, 515	1751	942	1883	143	2483	708
1067	381, 550	1219	1006	1352	42	1489	447	1621	560	1752	943, 1055	1884	210	2486	1194
1068	333	1220	1007	1353	41	1490	548	1622	560	1753	404	1885	208	2494	344, 986
1069	350	1221	1020	1354	849	1491	552	1623	557	1754	771	1886	208	2497	170
1070	349, 609	1222	536	1355	849	1492	18	1624	557	1755	248	1887	189	2500	374, 825
1071	346	1223	461	1356	858	1493	163	1625	557	1756	248	1888	152	2501	346
1072	346	1224	461	1358	849	1494	176	1626	556	1757	360	1889	178	2513	1197
1073	347, 607	1225	133	1359	52	1495	1061	1627	88, 565	1758	360	1890	185	2514	1197
1075	516	1226	134	1360	52	1497	1061	1628	573	1759	356, 1038	1891	185	2525	170
1076	516	1227	490	1361	81	1498	584	1629	231, 570	1760	280	1892	205	2536	708
1077	516	1228	441	1362	80	1499	1122	1630	743	1761	280	1893	175	2537	708
1079	646	1229	492	1363	23	1500	845	1631	743	1762	334	1894	179	2541	1185
1080	111	1230	552	1364	300	1501	837	1632	760	1763	273	1895	679	2544	1186
1081	28	1231	552	1365	300	1502	844	1633	755	1764	273	1896	717	2545	1185
1082	114	1232	549	1366	57, 125	1503	838	1634	756	1765	273	1897	681	2546	170
1083	66	1233	47	1367	121	1504	837	1635	756	1766	270	1898	680	2547	170
1084	1017	1234	86	1368	1151	1505	736, 807	1636	765	1767	270	1899	671	2549	708
1085	1017	1235	96	1369	1151	1506	734, 811	1637	765	1768	277	1900	708	2552	708
1088	1007	1236	763	1370	1153	1507	838	1638	761	1769	277	1901	679	2553	709
1089	223	1237	755	1371	1143	1508	813	1639	670, 751	1770	275	1902	679	2554	345, 987
1090	388	1238	766	1372	1146	1509	813	1640	751	1771	350	1903	678	2555	345, 987
1091	386	1239	758	1373	601	1510	969	1641	672, 752	1772	549	1904	678	2556	841
1092	386	1240	651	1374	1162	1511	737	1642	672, 752	1773	583	1905	678	2586	1209
1093	387	1241	592	1375	722	1512	737	1643	662, 672, 752	1774	305, 320, 1039	1906	717	2596	171
1094	387	1242	601	1376	722	1513	831	1644	750	1775	319, 1046	1907	717	2597	261, 707, 984, 1051
1095	384	1243	1170	1377	722	1514	972	1645	768	1776	353, 1044	1908	638, 727	2599	1022
1096	550	1244	1195	1378	722	1515	956	1646	774	1777	332, 1044	1909	716	2602	1209
1097	660	1245	465	1379	722	1517	804	1647	778	1778	355, 1043	1910	716	2607	414
1098	392	1246	995	1380	1123	1518	805	1648	561, 754	1779	309	1911	117, 716	2611	1209
1099	365	1247	384	1382	659	1519	805	1649	676, 748	1780	292	1912	699	2613	1209
1100	387, 961	1248	391, 422	1383	65	1520	812	1650	616, 696, 748	1781	292	1913	736	2617	170
1111	553	1249	415	1385	1150	1521	735, 808	1651	669, 1069	1782	292	1914	732	2616	703
1112	553	1250	415	1386	93	1522	791	1652	669, 1069	1783	292	1915	732	2617	1201
1113	601	1251	516	1387	614	1523	801	1653	612, 636	1784	296	1916	678	2618	117, 718
1114	546	1252	701	1388	543	1524	796	1654	605	1785	296	1917	681	2623	427
1115	845	1253	301	1389	301	1525									

REF.	PAG.	REF.	PAG.	REF.	PAG.	REF.	PAG.	REF.	PAG.	REF.	PAG.	REF.	PAG.	REF.	PAG.
2686	1201	3356	1158	3951	957	4439	534	4746	622	5096	682	5381	242	5651	1194
2687	1201	3357	1159	3958	485	4442	723	4747	626,644	5097	778	5384	463	5652	1197
2688	543	3363	1147	3960	474	4443	1200	4748	1213	5098	1178	5385	463	5655	721
2689	1153	3365	421	3963	363	4452	1212	4749	363	5099	814	5392	1166	5657	1202
2690	688	3368	1195	3974	71	4455	751	4751	8374	5100	831	5395	25	5659	728,833
2691	1206	3382	553	3980	1182	4456	496,788	4755	1126	5101	350	5397	1172	5661	193
2692	684	3384	299	3987	503,824	4466	234,523	4756	1216	5102	721	5400	240	5667	206
2699	1151	3386	499,793	3996	1205	4468	1178	4761	1209	5107	1147	5403	821	5668	207
2700	1151	3388	195	4001	616	4471	1217	4762	703,990	5110	1142	5418	475	5670	205
2702	584	3389	195	4002	616	4472	518,1116	4769	1218	5113	689	5419	394	5672	196
2704	582	3392	814	4003	1194	4473	1174	4770	1218	5114	1212	5424	78	5674	876
2705	1155	3393	201	4010	1029	4477	1205	4771	1216	5118	191	5437	851	5676	876
2713	310	3402	161	4014	1169	4478	428,1048	4774	668,1067,1068	5119	489,874	5438	1067	5677	876
2714	310	3403	613,638	4028	389,825	4479	910	4775	423	5120	481	5439	797	5681	1167
2715	337	3424	142	4034	721,1157	4503	639	4777	949	5121	475	5440	544,530	5685	362
2716	337	3425	821	4037	483	4509	352,545	4778	1205	5122	1182	5441	530	5686	362
2717	672,752	3429	778	4043	246	4513	73	4779	1203	5123	1210	5442	531	5688	366
2718	672,752	3430	1193	4055	779	4514	1196	4780	244	5125	518	5444	531	5689	651
2719	430	3437	193	4057	240	4515	1196	4781	421	5127	1191	5445	218	5693	852
2720	430	3440	1195	4060	197	4516	1171	4784	708	5130	1214	5446	219	5695	316
2721	430	3444	1195	4086	521,970	4520	251	4785	1202	5131	1028	5447	927	5696	709,948
2722	211	3450	870	4092	1171	4521	989	4788	826	5132	832,1032	5448	424	5699	698
2723	211	3451	885	4094	240	4524	1181	4798	1088	5134	891	5449	1185	5700	997
2724	757	3477	163	4096	482	4526	1203	4799	939	5136	1199	5451	400	5703	797
2725	757	3480	668,1068	4097	949	4530	1202	4800	1213	5139	500,792	5452	409	5704	954
2726	757	3481	668,1068	4098	1194	4531	520,992	4804	968	5140	1155	5454	261,707,984	5705	252,826
2727	757	3484	714	4103	1168	4535	1196	4805	1137	5141	1155	5455	1051,1156	5706	1012
2728	757	3503	1017	4108	116	4536	1196	4808	1190	5142	1161	5456	886	5707	1012
2729	430	3523	115	4112	117	4537	1196	4811	1196	5148	542	5457	886	5708	860
2730	430	3523	487	4113	1199	4538	1192	4812	1192	5154	1162	5465	926	5709	861
2731	430	3526	157	4130	1171	4541	536	4819	583	5155	219	5466	1154	5715	813
2732	171	3527	1181	4131	1202	4546	1188	4820	1176	5157	1166	5469	1154	5716	812
2733	171	3540	1169	4132	1195	4548	1169	4821	299	5160	112	5470	1154	5717	1206
2734	171	3551	25	4133	1178	4551	1138	4824	167,997	5162	87	5471	1206	5718	734,809
2735	171	3553	1157	4134	1157	4552	1219	4826	263	5168	1185	5472	1206	5719	719
2736	171	3554	1187	4135	1194	4553	955	4828	908	5170	747	5473	634,823	5720	904
2738	896	3564	440	4146	1195	4554	510	4830	1199	5173	391	5474	1199	5724	235
2739	896	3569	1191	4147	395	4557	1210	4831	1211	5175	700	5482	431	5725	417,962
2740	892	3571	959	4168	626	4565	1195	4834	918,991	5176	700	5483	431	5726	417,964
2741	892	3572	518,967	4169	1196	4567	510	4835	992	5178	590	5484	431	5727	775
2742	893	3574	425	4170	425	4571	1203	4838	1206	5180	603	5485	431	5728	966
2743	892	3575	924	4171	559	4574	74	4840	581	5181	598	5486	431	5729	776
2744	892	3578	1216	4173	495,818	4575	503	4841	1126	5182	363	5487	668,1068	5730	927
2745	893	3583	728	4182	568	4576	1171	4843	650	5183	354,1041	5488	551	5733	1176
2746	893	3584	316	4184	1077	4577	1169	4845	709	5184	354,1041	5489	551,959	5735	493,820
2747	985	3585	138,821	4185	1076	4578	968	4847	540,946	5192	1152	5490	957	5736	417
2748	892	3592	707	4186	1076	4579	71	4848	540,946	5193	1152	5491	299	5737	395
2749	685	3599	1205	4187	1109	4581	940	4855	1166	5194	367,642	5494	341	5738	408
2750	685	3609	1207	4189	1162	4582	614	4859	207	5199	92	5496	1194	5739	1165
2751	344,986	3616	1190	4190	920	4586	885	4860	1167	5200	1166	5499	1174	5740	1165
2752	344,986	3618	519	4207	726	4589	726	4866	1191	5201	92	5500	727	5741	1163
2753	344,986	3632	232	4208	870	4591	218	4869	157	5202	56,146	5501	1203	5747	1217
2754	344,986	3639	1209	4210	1209	4592	1173	4870	526,644	5206	1183	5502	256	5748	1217
2755	344,986	3640	155	4211	209	4593	1192	4871	1197	5207	1174	5504	922	5749	1168
2756	344,986	3641	498,790	4213	1173	4594	1199	4873	1176	5213	1019	5506	832,1032	5757	1165
2757	345,987	3643	499,793	4214	1213	4596	316,828	4874	341	5214	620,1054	5507	1021	5761	1163
2758	345,987	3646	1171	4215	1023,1050	4597	1182	4875	285	5215	620,1054	5510	510	5764	73
2759	344,986	3658	698	4217	940	4598	1182	4876	1206	5219	1154	5511	954	5769	1160
2760	344,986	3661	700	4221	940	4599	1182	4877	1206	5221	680	5512	954	5771	1162
2761	985	3665	1193	4222	492	4600	922	4882	1182	5224	1183	5513	303,320	5772	36
2762	985	3668	218	4223	492	4601	1013	4883	417,964	5225	909	5516	168,998	5776	1160
3003	234	3685	529	4224	1203	4605	699	4885	1211	5226	909	5517	168,998	5779	84
3020	867	3687	1208	4226	1203	4607	703,990	4887	204	5227	1210	5517	168,998	5780	1208
3025	833	3696	783	4227	1067	4608	1214	4889	207	5228	242	5520	120,1053	5781	1169
3029	914,991,1050	3701	169	4232	56	4609	1200	4890	1183	5232	227	5522	514	5785	1163
3047	416	3704	812	4234	990	4610	1200	4895	1183	5234	251,394	5523	522	5787	1161
3052	762	3708	491,784	4235	568	4611	1200	4897	1186	5235	252,394,825	5525	735,810	5791	489,874
3055	822	3709	167,262,997	4237	192	4612	433	4898	140	5238	164	5527	1209	5792	1181
3061	844	3714	491,783	4242	1169	4613	163	4900	912	5239	829,916	5528	55	5793	616
3062	842	3715	491,784	4243	1168	4615	800	4901	906	5244	111	5529	55	5795	1170
3063	842	3720	832,1032	4250	850	4616	1191	4902	906	5246	55	5531	26	5796	919
3072	395	3721	832,1032	4258	1148	4618	841	4903	400	5248	1081	5532	55	5799	1210
3074	1176	3724	721	4260	1148	4621	408	4907	792	5249	1080	5534	872	5800	1165
3095	494,818	3726	168,998	4262	1016	4622	425	4913	1217	5249	1080	5550	872	5801	119
3103	163	3727	1205	4264	617	4624	100	4914	515	5250	1102	5551	118	5804	1203
3115	520,970	3731	1167	4267	1168	4627	1166	4915	544,853	5251	1102	5552	1012	5806	331
3120	914	3732	1167	4270	799	4628	39	4936	39	5252	424	5554	913	5808	408
3123	1210	3741	703,990	4273	1194	4630	1209	4939	39	5253	424	5555	1174	5809	1184
3131	481	3743	702	4276	850	4635	1163	4940	1165	5255	474	5556	558	5815	851
3132	935	3754	1148	4278	1192	4636	1202	4947	1165	5257	698	5557	487	5817	1024
3136	1189	3760	854	4281	1189	4639	517	4950	1209	5259	854	5559	1174	5825	1189
3139	1190	3761	853	4283	1167	4640	1191	4970	746	5260	444	5560	321,828	5826	842
3142	207	3767	1158	4290	1193	4643	8								

REF.	PAG.	REF.	PAG.	REF.	PAG.	REF.	PAG.	REF.	PAG.	REF.	PAG.	REF.	PAG.	REF.	PAG.	REF.	PAG.
5903	734	6122	421	6335	477	6489	166, 783	6666	31	6825	769	6983	761	9124	860		
5904	517	6123	421	6336	481	6490	166	6667	71	6827	769	6984	761	9146	232		
5905	1206	6124	96	6337	908	6491	528	6668	71	6828	775	6985	811	9147	779		
5907	762	6125	97	6338	179	6492	543	6670	1204	6829	412	6986	502, 824	9156	971		
5909	1189	6127	580, 850	6340	419	6493	419	6671	1204	6830	412	6987	253, 827	9162	496, 790		
5911	1189	6128	224	6341	419	6494	232	6672	1172	6831	623	6988	390	9169	263, 997		
5913	1023	6130	62	6342	568	6495	442	6675	375	6832	767	6989	637	9173	861		
5914	1024	6132	63	6343	242	6496	440	6676	338	6833	247, 399	6990	668, 1068	9188	556		
5915	1211	6140	127, 1053	6344	242	6497	801	6677	342	6835	402	6991	656	9195	924		
5916	1031	6141	87, 564	6345	227	6498	598	6678	1206	6836	409	6992	605	9208	1212		
5917	519, 1028	6142	62	6346	483	6499	297	6679	139, 822	6837	191	6993	663	9212	644, 918		
5918	1143	6143	35	6347	484	6500	484	6680	119	6838	98	6994	599, 662	9216	1011		
5919	955	6149	62	6349	1147	6501	671	6681	841	6840	254	6995	654	9235	1171		
5920	510	6151	815	6350	482	6502	671	6682	383	6841	233, 569	6996	654	9248	1019		
5922	968	6155	1214	6353	738	6503	670, 765	6684	1200	6842	773	6997	1197	9258	1171		
5923	939	6156	307	6354	938	6504	670, 765	6685	118	6843	681	6998	607	9271	1201		
5924	1213	6157	182	6355	936	6506	38	6686	118	6844	153	6999	349, 367	9272	724		
5925	484	6158	1017	6357	1017	6507	32	6687	119	6845	159	7000	939	9273	723		
5932	1170	6159	178	6358	112	6509	165, 226	6688	21	6846	159	7001	1213	9288	1196		
5933	1205	6160	774	6359	353, 1044	6510	27	6689	100	6847	149	7003	815, 940	9301	106		
5934	682	6162	290	6360	797	6511	21	6690	1202	6848	216	7014	1203	9303	1186		
5935	839	6163	291	6361	381	6513	237, 539, 947	6691	1207	6849	384	7032	1199	9316	603		
5938	422	6164	319, 1046	6362	670, 751	6514	601	6692	480, 784	6850	241	7035	1214	9321	804		
5939	197	6165	318, 1045	6363	670, 751	6515	680	6693	1179	6851	528	7036	1195, 955	9325	900		
5940	1154	6166	501	6365	1189	6516	48	6695	373	6852	528	7087	574	9343	943		
5941	1155	6167	501, 795	6366	452	6517	46	6697	713	6854	1025	7123	574	9348	1214		
5942	744	6168	236, 538	6367	452	6520	73	6698	1204	6855	1029	7153	1014	9384	1179		
5946	126	6169	166	6368	452	6521	67	6699	72	6856	1022	7154	1015	9416	728		
5947	225	6170	336	6369	1180	6522	72	6700	34	6858	276	7157	1014	9417	974		
5948	1165	6171	839	6370	1180	6523	82	6701	74	6859	277	7162	1014	9459	366		
5949	225	6172	528	6371	1172	6524	82	6702	67	6860	329	7163	427	9550	833		
5953	25	6175	414	6372	388, 432	6528	32	6703	1029	6861	351	7166	472	9554	1197		
5955	1163	6179	119	6373	508	6530	290	6704	1172	6862	285	7170	279	9562	886		
5960	1130	6181	35	6374	534	6531	291	6705	1207	6863	283	7185	1198	9566	1207		
5964	133	6182	71	6375	256	6533	144	6706	342	6864	302	7188	1198	9574	143		
5972	224, 527	6184	63	6378	638	6538	638	6707	347	6865	347	7217	1197	9579	872		
5975	452	6185	174	6379	800	6535	71	6708	375	6866	302	7218	1169	9579	1208		
5980	180	6186	719	6380	813	6536	71	6709	132	6867	304	7227	1169	9587	157		
5981	586	6193	1170	6381	971	6537	67	6716	1173	6868	304	7236	1187	9589	967		
5982	246	6196	258	6382	780	6539	83	6718	785	6869	346	7248	1015	9607	494, 673, 868		
5983	411	6198	306	6383	780	6540	35	6719	785	6870	303, 320	7257	1211	9639	256		
5984	365	6199	983	6384	780	6541	35	6720	809	6871	303	7261	1191	9642	725, 856		
5986	298	6200	992	6387	411, 964	6542	72	6721	480, 784	6872	311	7266	1191	9648	666		
5990	1201	6201	98, 196	6388	964	6543	206	6722	176	6873	311	7344	40	9663	1184		
5991	204	6203	982	6389	403	6544	66	6723	1188	6874	308	7353	1187	9664	993		
5999	1168	6204	719	6390	248	6546	40	6724	378	6875	336	7359	471	9670	814		
6001	764	6205	720	6391	402	6554	763	6725	526	6876	336	7360	279	9675	1171		
6005	643	6206	626	6392	626	6556	572	6726	774	6877	274	7362	279	9678	911		
6006	781	6207	915	6393	999	6557	670, 765	6727	411	6878	290	7363	262	9679	657		
6007	1167	6208	1210	6394	179	6558	1026	6728	459	6879	1174	7363	160	9696	440		
6009	285	6209	140	6395	202	6559	95	6729	180	6880	1174	7364	148	9705	1210		
6014	930	6213	477	6396	202	6560	95	6730	1185	6881	298	7369	53	9710	792		
6015	720	6215	227	6397	202	6561	96	6731	479	6883	298	7370	471	9718	583		
6016	1192	6216	255	6398	193	6562	337	6732	772	6884	1173	7371	471	9723	245		
6018	182	6218	255	6399	195	6563	112	6733	67	6885	1173	7372	471	9728	113		
6019	474	6219	254	6400	207	6564	540, 946	6737	133	6886	445	7373	228, 575	9735	783		
6020	798	6220	219	6401	182	6565	204	6738	34	6887	381	7374	230, 575	9736	1170		
6022	1182	6221	1084	6402	506	6566	1170	6739	72	6889	1204	7375	575	9740	1207		
6026	1181	6222	1084	6403	1175	6567	476, 673	6740	72	6891	24	7376	329	9751	156		
6027	1189	6223	688	6404	1084	6571	785	6741	76	6892	84	7377	379	9768	993, 1159		
6028	1186	6224	1208	6405	112	6572	413	6743	35	6893	79	7378	98, 471	9771	419		
6031	738	6226	52	6406	933	6574	90	6744	74	6895	78	7379	203, 691	9774	139, 872		
6033	1187	6228	96	6407	934	6575	119	6745	34	6902	852	7380	23	9777	1184		
6035	1184	6229	97	6408	584	6577	413	6746	51	6903	1145	7381	76	9781	1214		
6036	445	6232	95	6409	318, 1045	6579	566, 586	6747	51	6904	1150	7382	469	9800	561, 754		
6039	502	6233	95	6410	487	6580	506	6748	1020	6905	1144	7383	669	9801	1199		
6041	535, 854	6234	1033	6411	867	6581	802	6749	216	6906	1144	7384	470	9810	500, 791		
6042	738	6236	93	6412	956	6582	306, 320	6755	1115	6907	142	7385	470	9831	500, 791		
6043	233, 569	6238	94	6413	39	6584	1174	6756	1133	6908	1148	7386	466	9833	1149		
6044	164, 572	6240	94	6414	1011	6585	359	6757	1132	6909	217	7387	466	9843	1171		
6045	1018	6242	94	6415	259, 996	6586	359	6759	1134	6910	160	7388	467	9844	1177		
6047	228, 571	6246	506, 542	6417	813, 808	6589	1017	6760	1098	6911	348	7389	467	9848	1177		
6048	406	6247	198, 823	6418	731	6590	566, 586	6761	1205	6912	172	7390	467	9850	127		
6049	406	6250	536	6419	734, 811	6591	118	6762	1202	6913	172	7391	466	9855	885		
6050	410	6251	224	6420	902	6592	118	6763	197	6916	378	7392	228	9860	942		
6051	622	6255	1197	6421	904	6593	1194	6764	129	6917	547	7394	466	9862	1016		
6052	93	6256	1160	6422	418	6594	1192	6765	1188	6918	337	7395	466	9884	764		
6056	622	6257	122	6423	773	6595	998	6766	1188	6919	572	7400	1088	9885	494		
6058	727	6259	1160	6424	814, 823, 827	6597	225, 393	6767	414	6920	169	8001	1089	9901	801		
6061	725	6260	1160	6425													

REF.	PAG.	REF.	PAG.	REF.	PAG.	REF.	PAG.	REF.	PAG.	REF.	PAG.	REF.	PAG.	REF.	PAG.
20148	453	20279	10	20432	506	20572	599	20718	284	20855	38	20987	638	21128	227
20149	453	20280	10	20435	526	20573	618	20719	294	20856	81	20988	677	21129	573
20150	484, 820	20281	60	20436	529	20574	592	20720	294, 314, 513	20857	84	20989	677	21130	411
20151	128	20282	60	20437	529	20575	605	20721	308	20858	85	20990	677	21131	246
20152	335, 640	20283	60	20438	529	20576	580, 693	20722	314, 513	20859	86	20991	677	21132	401
20153	335, 640	20284	61	20439	525	20577	595	20723	309	20860	87, 120	20992	679	21133	243
20154	1028	20285	61	20442	527	20578	595	20724	308, 321	20861	89, 135	20993	710	21134	398
20155	911, 1027	20286	61	20443	527	20580	605	20725	310	20862	114	20994	710, 888	21135	155
20156	109, 994	20287	479	20444	526	20581	619	20726	305	20863	28	20995	711	21136	412
20157	911, 1027	20288	27	20445	519	20582	599	20727	303	20864	28	20996	711	21137	1099
20159	1019	20289	141	20446	315, 512	20583	599	20728	313	20865	42	20997	711	21138	1099
20160	1002	20290	141	20447	315, 512	20584	613, 638	20729	304	20866	18	20998	711	21139	1099
20161	733, 805	20291	88, 563	20448	314, 512	20585	599	20731	283	20867	112	20999	766	21140	1091
20162	302	20292	103	20449	315, 512	20586	618	20732	271, 691	20868	145	21000	113	21141	1090
20163	341	20293	31	20450	519	20587	602, 634	20733	271	20869	145, 628	21001	715	21142	1090
20164	340	20294	21	20451	521	20588	602, 634	20734	297	20870	100	21002	724	21143	1111
20165	190, 817	20295	20	20452	507, 697, 749	20589	591	20735	317	20871	29	21003	718	21144	1110
20166	190	20315	844	20453	234, 523	20590	591	20736	317, 513	20872	20	21004	725, 856	21145	1108
20167	190, 817	20316	837	20454	234, 523	20591	591	20737	317, 695, 931	20873	21	21005	721	21146	1131
20168	1124	20317	837	20455	534	20592	619	20738	290, 318, 1047	20874	22	21006	718	21147	1132
20169	1124	20318	836	20456	352, 545	20593	594	20739	969, 1055	20875	47	21007	655, 724	21148	1133
20170	1126	20319	836	20457	352, 545	20594	612	20740	561, 1053	20876	65	21008	712	21149	1074
20171	1129	20320	836	20458	535, 710	20595	596	20741	150, 1053	20877	28	21009	712, 888	21150	1083
20172	1129	20321	839	20459	236, 538, 959	20596	591	20743	563	20878	146, 146	21010	712, 888	21151	1083
20173	1137	20322	838	20460	546	20597	615	20744	113	20879	91	21011	713, 874	21152	1082
20174	1130	20323	839	20461	546	20598	629	20745	110	20880	220	21012	615, 725	21153	1108
20175	1136	20324	840	20462	541, 947	20599	629	20746	109	20881	215	21013	54	21154	1109
20176	1135	20325	840	20463	541, 947	20600	582	20747	109	20882	165, 215	21014	54	21155	1074
20177	1117	20326	840	20464	237, 539, 947	20601	583	20748	113	20883	215	21015	36	21156	1075
20178	764	20327	841	20465	541, 945	20602	583	20749	113, 489, 874	20884	215	21016	36	21157	1075
20179	507, 697, 749	20328	842	20466	541, 945	20603	582	20750	113	20885	229, 571	21017	457, 577, 676	21158	1078
20180	454	20329	843	20467	547	20604	582	20751	951	20886	230, 570	21018	30	21159	1078
20181	457	20330	843	20468	548	20605	579, 692	20752	950	20887	221	21019	55	21160	1087
20182	447	20331	845	20469	553	20606	587, 676	20753	950	20888	221	21020	33	21161	1087
20183	449	20332	844, 971	20470	553	20607	578, 692	20754	952	20889	241	21021	49, 897	21162	1087
20184	454	20333	843	20471	713, 865	20608	578, 692	20755	965	20890	241	21022	49, 897	21163	1083
20185	454	20334	1020	20472	865	20609	578, 692	20756	965	20891	239	21023	83	21164	1075
20186	478	20335	1030	20473	865	20610	370	20757	901, 965	20892	237, 533	21024	555, 694	21165	900
20187	478	20336	1018	20474	865	20611	372	20758	963	20893	237, 533	21025	87, 564	21166	1025
20188	717, 856	20337	1022	20477	868	20612	380	20759	963	20894	237, 533	21026	269, 328	21167	1023
20189	733, 809	20338	1026	20478	871	20614	380	20760	945	20895	228, 571	21027	269	21168	900
20190	712	20339	1029	20479	873	20615	381	20761	941	20896	257	21028	268, 328	21169	968
20191	712	20340	1005	20480	873	20616	380	20762	934	20897	257	21029	268, 328	21170	975
20192	712	20341	1005	20481	875	20617	385	20763	934	20898	255	21030	268, 328	21171	683
20193	715	20342	1005	20482	875	20618	387, 961	20764	937	20899	255	21031	19	21172	330
20194	882	20343	1008	20483	878	20619	370, 961	20765	145, 931	20900	233	21032	116	21173	255
20195	379	20344	1004	20484	879	20620	372	20766	110, 145, 931	20901	249	21033	89	21174	390
20196	338	20345	1024	20485	881	20621	372	20767	110, 145, 931	20902	249	21034	105	21175	114
20197	343, 379	20346	832, 1033	20486	535, 881	20622	225, 393	20769	930, 995	20903	243, 515	21035	104	21176	114
20198	379	20347	1005	20487	710, 875	20623	395	20770	998	20904	244	21036	9	21177	395
20199	223	20348	1059	20488	883	20624	387	20771	400	20905	244	21037	8	21178	1091
20200	231, 570	20349	557	20489	883	20625	381	20772	400	20906	243	21040	8	21179	1090
20201	162	20350	557	20490	714, 883	20626	381	20773	244, 418	20907	247	21041	8	21180	1090
20202	1148	20351	558	20491	883	20627	381	20774	246	20908	247	21042	9	21181	1090
20203	284	20352	561, 754	20492	881	20628	381	20775	405	20909	241	21043	105	21182	1110
20204	340	20353	562, 755	20493	878	20629	380	20776	247, 405	20910	579, 693	21045	86	21183	482
20205	340	20354	229, 571	20494	864	20630	380	20777	405	20911	758	21046	159, 226	21184	108
20206	272	20355	573	20495	713, 864	20631	380	20778	1064	20913	759	21047	767	21185	103
20207	272	20356	562	20496	877	20632	381	20779	1064	20914	115, 136	21048	391	21186	65
20208	341	20357	567	20497	877	20633	388	20780	1064, 965	20915	201	21049	717	21187	70
20209	287	20360	558	20498	73	20634	389	20781	401	20916	167, 262	21050	177	21188	111
20210	333, 641	20361	559	20499	873	20635	919, 991	20782	951	20917	152	21051	618	21189	80
20211	351, 641	20362	568	20500	867	20636	703, 990	20783	326	20918	138	21052	937	21190	58
20212	333, 641	20363	567	20501	864	20637	703, 990	20784	326	20919	137	21053	308	21192	58
20213	282	20364	88, 565	20503	871	20638	993	20785	669, 1069	20920	211	21054	769	21193	58
20214	282	20365	555, 694	20504	489, 871	20639	263, 997	20786	664	20921	211	21055	665	21194	58
20215	151	20366	555, 694	20505	518, 912	20640	489	20787	664	20922	211	21056	665	21195	86
20216	129	20367	832, 1033	20506	829, 917	20641	439	20789	660	20923	147	21057	717	21196	59
20217	177	20368	791	20507	829, 917	20642	439	20790	659	20924	141	21058	273	21197	18, 83
20218	206	20369	798	20508	865	20643	439	20791	659	20925	137	21059	68, 131	21198	10
20219	178	20370	497, 789	20509	354, 1040	20644	439	20792	637	20926	135	21060	667	21199	37
20220	187, 817	20371	497, 789	20510	357, 642, 1038	20645	439	20793	656	20927	148	21061	211	21200	17
20221	186	20372	497, 789	20511	356, 1038	20646	441	20794	657	20929	258	21062	202	21201	17
20222	183	20373	814	20512	356, 1038	20647	441	20795	655	20930	260, 705	21063	114	21202	17
20223	187	20374	448, 819	20513	357, 642, 1042	20648	443	20796	655	20931	167, 262, 783	21064	463	21203	17
20224	483	20375	448, 819	20514	341, 357, 1039	20649	443	20797	650	20932	153	21065	270	21204	70
20225	446	20376	137, 821	20515	305, 320, 1039	20650	443	20798	650	20933	158	21066	719	21205	

NAMES	PAGES
Bottle Cooler	656, 657, 1197
Bottle Holder	611, 1197
Bottle Holder	392
Bottle Holder	647
Bottle of Red Wine	738
Bottle of White Wine	738
Bottle Opener Level	864
Bowl	838
Bracelet	705, 706, 815, 833, 981, 982, 983, 1157, 1191, 1199
Braces	1199
Bread Basket	602
Briefcase	160, 161
Brush	616
Bubbles	815
Bucket	646
Cable Pouch	857
Calculator	143, 1170
Caliper	896
Caliper	896
Camouflage Cap	915
Candle	1150
Cap	901, 902, 903, 904, 905, 906, 907, 908, 909, 910, 911, 913, 914, 915, 1159, 1210
Cap	660
Carabiner	722, 726
Card	1062
Card Holder	678, 679, 680, 1167, 1203
Card Holder Wallet	679
Card Set	136
Chair	551, 958, 959
Chair Cool Bag	236, 959
Chair Cover	1148
Chalk Set	498
Champagne Bucket	648
Charger	8, 10, 11, 13, 17, 58, 59, 60, 62, 64, 65, 66, 67, 68, 70, 71, 72, 73, 74, 75, 78, 79, 1160, 1163
Charger Backpack	224, 236
Charger Cup Warmer	70, 144
Charger Earphones	18, 24
Charger Holder	15, 16, 76, 78, 849
Charger Lamp	42
Charger Mousepad	57, 126
Charger Notepad	174
Charger Organizer	1172
Charger Speaker	30, 40
Charger UV Sterilizer Box	1204
Charger UV Sterilizer Lamp	1204

NAMES	PAGES
Chargers Set	88
Charging Cable	9, 10, 11, 12, 16, 17, 61, 63, 101, 102, 103, 104, 105, 1163
Charging Cable Set	103
Cheering Sticks	993, 1158
Cheese Knife Set	595, 596, 597, 1195
Chef Hat	626
Chess	732
Chopsticks Set	599, 603, 1195
Christmas Card Decoration	1145
Christmas Decoration	1144, 1145, 1146, 1147
Christmas Decoration	1146
Christmas Decoration Set	1145, 1146, 1147
Christmas Hat	1149
Christmas Tree	1144, 1147
Cigarette Pack Cover	1202
Cleaner Brush	297
Cleaner Cloth	1052
Cleaner Pen	113
Cleaning Set	113, 1169
Clip	137, 1170
Clip Bookmark	1169
Clip Memo Holder	1205
Clip Opener	612
Clips Holder	137, 1170
Coaster	643, 980, 1194
Coaster Set	604, 605, 1148, 1153
Cocktail Set	610, 649, 652, 1197
Cocktail Shaker	648, 651
Coin Tray	1193
Colouring Book	1203
Comb	670, 765
Combitester	895
Compass	534
Condenser Microphone	28
Cool Bag	387, 391, 960
Cool Bag	370, 384, 385, 386, 387, 388, 390, 391, 393, 395
Cool Bag Backpack	225, 251, 252, 393, 394, 550
Cool Bottle	392, 1176
Cool Eye Mask	747
Cool Eye Mask	747
Cord Winder	1168
Corkscrew	613, 637, 639, 659
Corkscrew Opener	612, 613, 637, 639
Corkscrew Pocket Knife	888
Cosmetic Pad Dispenser	758

NAMES	PAGES
Crayon Set	498, 500
Cup	333
Cup	333, 334, 337, 338, 339, 340, 341, 344, 345, 346, 348, 349, 980, 1175
Cup Holder Clip	988
Cup Warmer	144
Cups Set	1152
Cushion	993
Cutlery Set	372, 379, 381, 382
Cutter	864, 872, 873
Dartball Board	814
Dashboard Holder	1168
Decorative Plant	578
Desktop Calendar	169
Diary	170, 171
Digital Photo Frame	45
Digital Skipping Rope	517
Digital Thermometer	783
Dispenser Bottle	841
Dispenser Clip	1194
Display Stand	632
Divot	531
Document Bag	154, 156, 158, 159, 160, 161, 162, 163, 1171, 1172
Document Bag Backpack	159, 165, 229
Dog Chew Toy	844
Dominoes	731, 812
Doudou	803
Drawstring Bag	244, 247
Drawstring Bag Pareo	952
Drink Stirrer	650, 1197
Drip Stop Ring	660
Drone	55
Duck	815
Duffel Bag	234, 235, 250
Earmuffs	1214
Earphone Car Charger	1209
Earphones	9, 12, 14, 15, 19, 20, 21, 22, 23, 24, 25, 26, 27, 59, 1161
Earphones Clip	20
Earplugs	562
Earrings	683, 1198
Eau de Toilette for Men	672
Eau de Toilette for Women	672
Electric Corkscrew	659

ENGLISH

NAMES	PAGES
Electric Lunch Box	378
Electric Salt and Pepper Mill	619
Electric Toothbrush	750
Emergency Hammer	851
Emergency Kit	544
Emergency Light	852
Emulsifier	756
Erasable Pen	484
Eraser Set	1154, 1190
Eternal Pencil	448, 449, 1180
Eternal Pencil Pen	447, 449
Eternal Stylus Touch Pencil	447
Everlasting Calendar	142
Everlasting Calendar Pencil Holder	135
Exercise Band	508
Exercise Band	509, 1207
Exercise Bands Set	509
Exercise Ring	508
Exfoliating Massage Brush	755
Exfoliating Massage Brush	756
Extendable Umbrella	1214
Eye Mask	561
Eyeshadow Applicator Set	760
Face Cleansing Brush	758
Face Massager	759
Facial Mask Set	760
Fan	110, 815, 930, 931
Fan Bottle	317
Feeding Pillow	839
Felt Tip Pen	493
Figures	1146
Filling Machine	1202
Fitness Set	509
Flag	705, 992, 1158
Flash	1166
Flip Flops	942, 943
Flowerpot	688, 689, 1206
Flowerpot Set	689
Flute Glass Set	334
Foldable Apron	1196
Foldable Bag	399, 402, 409, 411, 412, 413, 418, 421, 424, 426, 1178
Foldable Bag	1192

NAMES	PAGES
Foldable Bag Hanger	728
Foldable Bottle	287, 315
Foldable Bowl	838, 839
Foldable Cup	287, 315, 343, 781
Foldable Trolley	573
Folder	152, 153, 154, 155, 156, 157, 1171
Fondue	595
Fork	600
Foulard	1031
Foulard Pareo	1211
Fountain Pen	467
Frame	1207
Frisbee	798, 844, 971
Game	731, 733, 734, 736, 737, 805, 812, 814, 971, 1155
Game Petanque	736
Game Set	731, 732
Game Skittles	737
Gamepad	1166
Gamer Set	28
Garden Kit	685, 688
Gardening Set	884
Garment Bag	568
Gift Box	669, 1059, 1060, 1061, 1063
Gift Box	1059, 1209
Gift Hangtag	1062
Gift Hangtags Set	1062
Glasses	990, 1207
Glasses Strap	1212
Glide Disk	508
Globe	566
Gloves	884, 1028
Glow Bracelet	981
Glow Stick	981
Goal Post	520
Golf Ball	530
Golf Ball Cleaning Pouch	530
Golf Set	530, 531
Golf Tee	530
Golf Tee Card	530
Golf Towel	531
Golf Umbrella	531
Grater	599
Grinder	708
Grow Pouch	688
Hair Trimmer	555
Hairbrush	670, 764, 765
Hairbrush with Mirror	764
Ham Cover	413
Hammock	537, 548
Hand Fan	705, 932, 933, 934, 935, 1211
Hanger	297
Harmonica	799

NAMES	PAGES
Hat	900, 901, 915, 1024, 1025, 1026, 1143, 1149, 1159, 1197, 1210, 1214
Hat	920, 921, 922, 923, 924, 1210, 1211
Hatband	925, 926, 927
Headband	518
Headband	758
Headrest	958
Heart Seeds	687
Heat Pack	746, 1148
Highlighter	140, 141
Highlighter Set	140, 141
Hip Flask	655
Hip Flask Keyring	655
Holder	113, 114, 115, 116, 118, 120, 524, 525, 605, 632, 847, 848, 857, 1145, 1168, 1169, 1193, 1201, 1208, 1212
Holder	1205
Holder Bracelet	108
Holder Charger	14, 1208
Holder Document Bag	159
Holder Keyring	117
Holder Lanyard	109
Holder Notebook	175, 176, 180, 181, 185
Holder Organizer	150
Holder Pen	443, 475, 484, 1181, 1183, 1184
Holder Pouch	1167
Holder Sticky Notepad	175, 177, 181, 205
Holder USB Hub	91
Hot-Cold Pack	507, 746
Humidifier	580, 1193
Ice Bucket	633, 647
Ice Bucket Speaker	1197
Ice Grippers	1191
Ice Scraper	854, 855
Ice Scraper Keyring	716
Id Badge	167, 168, 263
Id Badge Lanyard	167
Id Holder	166
Indicator Backpack	224
Infuser	607
Insulated Bottle	268, 269, 270, 275, 276, 277, 279, 282, 284, 286, 287, 288, 289, 294, 295, 301
Insulated Cup	268, 269, 326, 327, 329, 330, 331, 332, 333, 334, 336, 337, 338, 339, 341, 346, 1175
Insulated Mug	268, 269, 326, 327, 329, 336, 347, 350
Iron	555
Jacket	1124, 1126, 1127, 1128, 1129, 1133, 1134, 1135, 1136, 1137, 1218, 1219

NAMES	PAGES
Jar	340, 341, 1176
Jar Set	601
Jewellery Box	683, 766
Jigger	648, 650
Jug	367, 609
Juicer Bottle	317, 1174
Kaftan	1211
Karaoke Speaker	29
Keyboard	1165
Keyboard Holder	1165
Keyring	615, 716, 717, 718, 719, 720, 721, 722, 723, 724, 725, 726, 728, 1154, 1157, 1200, 1201, 1202
Keyring Anticontact	713, 1202
Keyring Coin	716, 722, 724, 1200
Keyring Emergency Hammer	851
Keyring Pillbox	724
Keyring Purse	721
Keyring Raincoat	1017, 1214
Keyring Teddy	801, 1142
Kids Cap	829
Kids Christmas Hat	1149
Kids Colour Polo Shirt "keya"	1112
Kids Colour T-Shirt	1105
Kids Colour T-Shirt	1090, 1105, 1215
Kids Colour T-Shirt "keya"	1092
Kids Hat	829
Kids Hat	1206
Kids Sunglasses	815
Kids Sweatshirt	1122
Kids Technical Sweatshirt	1218
Kids T-Shirt	1076, 1078, 1080, 1084, 1087, 1099, 1102, 1217
Kids T-Shirt "keya"	1100
Kids White Polo Shirt "keya"	1112
Kids White T-Shirt	1105
Kids White T-Shirt	1090, 1105, 1215
Kids White T-Shirt "keya"	1092
Kit	753
Kitchen Cutting Board	590, 591, 592, 593, 594, 618, 1153
Kitchen Cutting Board Set	591, 618
Kitchen Lighter	709
Kitchen Mitten	620, 621, 832, 1196

NAMES	PAGES
Kitchen Set	598, 602, 620, 831, 1153
Kitchen Tongs	137, 599, 616, 1194, 1197
Kitchenware Camping Set	545
Kite	797
Kneeling Mat	1208
Knife	1194
Knife Block	594
Knife Peeler Set	1194
Knife Set	594
Lamp	138, 536, 578
Lanyard	109, 166, 258, 259, 260, 981, 1173
Lanyard Cup Holder	989
Laptop Pouch	147, 148, 149, 150, 151
Laser Pen	146
LCD Writing Tablet	198, 823
Lenses	1207
Letter Opener	1169
Light Box	586
Lighter	708, 709
Lint Remover	555
Lip Balm	742, 743, 744, 745
Log Carrier	552
Luggage Scales	567
Luggage Strap	567
Luggage Tag	556, 557, 1192
Lunch Box	371, 372, 373, 374, 375, 376, 377, 379, 380, 1176
Magnet	614, 615, 1144, 1151, 1196
Magnet Calendar	169
Magnet Photo Frame	614, 1196
Magnet Set	615
Magnetic Whiteboard	614
Magnifier	890, 891
Magnifier	890
Magnifier Bookmark	138
Magnifier Keyring	891
Mandala Set	500
Manicure Set	761
Map	566
Massager	507, 516, 696, 697, 1205
Massager	748
Mat	128
Mat	508, 516, 953, 954, 1211
Mat	1191
Measuring Bucket	892
Measuring Cup	892
Measuring Jug	893
Measuring Scale	894
Mechanical Pencil	470, 482
Medal	702

NAMES	PAGES
Message Board	1195
Message Hanger	1193
Microphone	111
Microscope	891
Milk Frother	619
Mini Air Conditioner	145
Mini Fan	145
Mini Heater	145
Mini Inflation Pump	526
Mini Multifunction Pocket Knife	885
Mini Notebook	204
Mini Pen	476, 488
Mini Puzzle	804, 812
Mini Table Football	737
Mini Zen Garden	585
Minigame Bowling	736
Mixer	28
Mobile Holder	1168
Model	677
Mold	1194
Mold Set	1194
Money Box	800
Mouse	12, 59, 100, 1165
Mousepad	127, 128, 129, 633, 1169
Mousepad Calendar	169
Mousepad Notebook	177
Mousepad Photo Frame	1169
Mug	326, 335, 342, 347, 348, 349, 351, 352, 358, 359, 360, 361, 362, 363, 364, 365, 366, 367, 704, 798, 1152, 1153, 1175
Mugs Set	348
Multifunction Alarm Clock	45
Multifunction Alarm Clock	10, 43, 45, 46
Multifunction Antibacterial Pen	480, 1188
Multifunction Arm Strap	534
Multifunction Charger	68
Multifunction Charging Cable	104, 105
Multifunction Eternal Pencil	447, 449
Multifunction Folder	124
Multifunction Holder	66
Multifunction Keyring	117, 713, 727
Multifunction Lamp	40, 41, 44, 70, 114
Multifunction Lamp	145

ENGLISH

NAMES	PAGES
Multifunction Laptop Pouch	148, 1172
Multifunction Mousepad	57
Multifunction Notepad	63, 124, 1172
Multifunction Pen	489, 713, 871
Multifunction Pencil Holder	63, 132, 133, 211
Multifunction Pocket Knife	879, 880, 885
Multifunction Tape Measure	866
Multifunction Travel Adapter	87
Multipurpose Bag	108, 502, 945, 949, 989, 1167, 1171, 1190, 1206, 1209
Multipurpose Bracelet	1207
Multipurpose Glasses Strap	1212
Multipurpose Hook	1194
Multipurpose Pouch	116, 1167
Multitool	535, 710, 711, 865, 868, 870, 871, 873, 875, 877, 879, 880, 1208
Multitool Keyring	712
Multitool Tape Measure	713, 865, 873
Muscle Roller	516
Nail File	755
Napkin Ring	632
Neck Warmer	832, 1022, 1023, 1026, 1214
Neck Warmer and Hat	1023, 1024
Neckerchief	705, 918, 919
Neckerchief Wrap	918
No Lens Glasses	1207
Notebook	176, 177, 180, 181, 182, 183, 184, 185, 186, 187, 188, 190, 191, 192, 193, 194, 195, 204, 821, 1151, 1170
Notepad	173, 175, 176, 177, 178, 179, 180, 183, 184, 188, 190, 192, 195, 197, 198, 199, 202, 203, 204, 205, 206, 207, 209, 704, 1170
Notepad	185, 207, 210, 211, 1170
Notepad Holder	136
Notepad Pencil Holder	211
Nutcracker	597
Office Set	206, 209
Olive Oil Premium	739
Olive Oil Premium Set	739
Opener	612, 613, 635, 638, 1194, 1197
Opener Coaster	636, 1197
Opener Keyring	638, 726, 727, 1154
Opener Tape Measure	713, 864
Opener Torch	881
Organizer	115, 136, 152, 632, 857, 1171

NAMES	PAGES
Organizer Band	1169
Organizer Charger	65, 66, 68, 69, 131
Organizer Mousepad	121
Ozone Generator	1204
Padlock	528, 567
Pai Pai	935, 1206
Pai Pai Pen	1189
Painting Set	993
Paperweight	700
Parka	1137, 1219
Passport Holder	1192
Peeler	618
Pen	438, 439, 440, 441, 442, 443, 444, 445, 446, 450, 451, 452, 453, 454, 455, 456, 457, 458, 459, 463, 464, 466, 467, 468, 469, 470, 471, 472, 474, 475, 476, 477, 478, 479, 481, 483, 484, 485, 486, 487, 488, 490, 491, 493, 704, 1154, 1180, 1181, 1184, 1185, 1186
Pen Pouch	492
Pen Torch	491, 493, 1189
Pencil	494, 495, 868, 1154, 1190
Pencil Case	136, 500, 501, 502, 503, 792, 796, 797, 1190, 1209
Pencil Holder	134, 135
Pencil Holder	134, 135
Pencil Set	496, 497, 499, 500
Pencil Set	1187
Pennant Flag	992, 1158, 1207
Personal Alarm	112
Pestle and Mortar	1195
Pet Brush	837
Pet Collar	842
Pet Lead	843
Pet Towel	837
Pets Bottle	840
Pets Brush	837
Pets Chair	836
Pets Game	836
Pets Glove	837
Pets Security Light	843
Pets Set	839, 840
Photo Frame	587
Photo Frame Holder	1201
Photo Frame Weather Station	47
Picnic Basket	548
Picnic Blanket	546
Picnic Cool Bag Backpack	547
Picnic Set	549, 550
Pillbox	780, 781, 782
Pillow	558, 560, 967, 1192
Pin	703, 981

NAMES	PAGES
Pin Loop	1207
Pizza Cutter	601
Place Mat	603, 1195, 1196
Plaque	700, 701
Plastic Bag Holder	1179
Plate	985
Plug Adapter	88, 1192
Pocket Ashtray	709
Pocket Knife	710, 879, 880, 886, 888, 889, 1208
Pocket Knife Keyring	712
Pocket Mirror	755, 762, 763
Pocket Protector	491
Poker Playing Cards	730
Polar Fleece	1125, 1126, 1127
Polo Shirt	1108, 1109, 1115, 1116, 1216
Pot Holder	620, 1196
Pouch	113, 525, 941, 1148, 1167, 1202, 1209
Power Bank	8, 10, 13, 14, 15, 17, 58, 59, 60, 62, 64, 76, 77, 78, 79, 80, 81, 82, 83, 84, 85, 86, 1160
Power Bank Earphones	18, 24
Power Bank Lamp	536
Power Bank Organizer	124
Power Bank Selfie Stick	1166
Power Bank Set	87
Presenter Laser Pointer	56
Pressure Gauge	853
Projector	56
Protector Holder	1168
Protector Pouch	1167
Purse	680, 681, 682, 1203
Purse Holder	1203
Puzzle	804, 812
Puzzles Set	804
Race Number Drawstring Bag	243
Race Number Holder Waistbag	515
Radio Alarm Clock	46
Rain Meter	895
Raincoat	1016, 1138, 1219
Raincoat	544, 832, 1016, 1017
Record Player	30
Recorder	799
Reflective Armband	506
Reflective Vest	506, 852
	896
Reversible Hat	911, 1027

NAMES	PAGES
Reversible Umbrella	1012
Ring Light	111
Ring Light with Tripod	28
Roll Up	999
Roller	444, 454, 466, 467, 471, 472, 475, 482, 1186
Rolling Pin	600
Ruler	139, 822, 869, 1190
Ruler Bookmark	138, 207, 210
Saddle Cover	528
Safety Set	112
Salad Set	598
Salt and Pepper Mill	601, 619
Sand Timer	585, 750
Sandwich Lunch Box	372, 374
Scale Ruler	139
Scarf	832, 1030, 1143, 1159, 1199
Scarf	1199
Scooter Bag	525
Screen Cleaner	1168
Security Light	833
Seed Bonbons	684, 685
Seed Bonbons Set	685
Seed Capsules	685
Seed Capsules Set	685
Seed Stick	687
Seeds Bookmark	138, 208
Seeds Christmas Decoration	1146
Seeds Crayon Set	497
Seeds Folder	155
Seeds Id Badge	263
Seeds Keyring	686
Seeds Notebook	188, 189
Seeds Notepad Holder	490
Seeds Pencil	494
Seeds Pencil Set	497
Seeds Set	497
Seeds Sticky Notepad	188, 189, 208
Selfie	1206
Selfie Pai Pai	1206
Selfie Set	1206
Selfie Stick	1166
Serving Dish	633
Serving Dishes	602, 1195
Serving Dishes	1195

NAMES	PAGES
Set	202, 203, 271, 316, 349, 444, 457, 460, 461, 463, 464, 465, 471, 472, 496, 497, 498, 499, 518, 562, 606, 608, 658, 672, 690, 691, 714, 745, 750, 751, 757, 765, 788, 791, 794, 795, 821, 831, 968, 1026, 1147, 1165, 1188, 1190
Set Playing Cards	730
Set Stone Ice Cubes	654
Sewing Kit	562
Shampoo	757
Shampoo Set	757
Sharpener	137, 821
Sharpener Kitchen Cutting Board	591
Shoe Bag	568
Shoe Bag	522, 568
Shoe Cleaning Set	562
Shoe Polisher	1192
Shopping Trolley	433
Shorts	1216
Shorts	518, 1123
Shorts	1217
Shot Glass Tray	651
Shoulder Bag	159, 237, 255, 257, 1171
Shoulder Bag Waistbag	255
Shovel	892
Skill Game	733, 734, 735, 808, 811, 812, 1155, 1206
Skill Games	814
Skill Games Set	734, 735
Skipping Rope	517
Sleeping Bag	536, 537
Slippers	671, 1021, 1086
Smart Bracelet	50, 52, 1162, 1164
Smart Camera	54
Smart Watch	51, 52, 53, 1162
Snow Shovel	535
Soap	757
Sock	1021, 1143, 1148, 1155
Soil Thermometer	895
Sound Amplifier	115
Space Blanket	544
Spanish Playing Cards	730
Spatula	598, 599, 600, 616, 1153
Speaker	12, 14, 29, 30, 31, 32, 33, 34, 35, 36, 37, 38, 39, 40, 63, 1162
Speaker Earphones	18
Speaker Keyring	1202
Speaker Microphone	29
Spice Set	601
Spinning Top	813, 1206

NAMES	PAGES
Sponge Bath	756
Spoon	598, 600, 1195
Sport Gloves	519
Spray Pen	1188
Stapler	137
Straw	383, 1176
Straw Drink Stirrer	650
Straw Set	382, 383, 1176
Stylus Touch Ball Pen	440, 442, 444, 445, 450, 451, 452, 453, 454, 455, 457, 473, 474, 475, 481, 483, 484, 486, 1181, 1182, 1183, 1187, 1188, 1189
Stylus Touch Pen	1166, 1202
Stylus Touch Pencil	1190
Sublimation Apron	626
Sublimation Bag	428
Sublimation Beach Rackets	969
Sublimation Beauty Bag	776
Sublimation Bottle	305, 318, 319
Sublimation Bracelet	261
Sublimation Cup	356
Sublimation Drawstring Bag	250
Sublimation Flip Flops	943
Sublimation Insulated Bottle	290, 319
Sublimation Insulated Cup	332
Sublimation Insulated Mug	353
Sublimation Jar	341
Sublimation Jug	357
Sublimation Lanyard	261
Sublimation Laptop Pouch	150
Sublimation Mug	353, 354, 355, 356, 357, 364
Sublimation Notepad	199
Sublimation Place Mat	1054
Sublimation Sock	1050
Sublimation Travel Eye Mask	561
Sublimation Vacuum Flask	318
Sun Visor	912, 1210
Sunglasses	936, 937, 938, 939, 940, 1212, 1213
Sunscreen Lotion	944
Sunshade	858, 859, 860, 861
Sushi Set	603, 1195
Swim Hat	518

ENGLISH

NAMES	PAGES
Table	536, 549, 1212
Tablet Case	147, 1167
Tally Counter	1207
Tape Measure	783
Tape Measure	712, 864, 866, 867
Tea Mug	347
Tea Storage Box	607
Teapot	607
Technical Jacket	1121
Teddy	801, 1142
Tent	537
Terrarium	684
Thermal Bag	386, 387, 388, 1176, 1205
Thermal Lunch Box	377, 378
Thermal Picnic Basket	548, 549, 551
Thermal Picnic Basket	432
Thermal Sandwich Holder	389
Thermal Snacks Holder	389
Thermometer	894
Timer	48, 616
Tool Set	873, 876, 877, 878
Toothbrush	670, 750, 751
Torch	506, 529, 542, 714, 715, 783, 881, 882, 883, 1191, 1193
Torch Keyring	714, 715, 716, 720
Touchscreen Gloves	832, 1028, 1029
Touchscreen Sport Gloves	519
Towel	510, 629, 953, 1191
Towel Pareo	950, 951, 952, 1199, 1211
Tracker	112
Trash Bag Holder	1179
Travel Document Holder	556
Travel Eye Mask	560, 561
Travel Set	559, 561, 1192
Tripod	111
Trolley	164, 572, 573, 574, 1192
Trolley Backpack	228
Trophy	701
Tube	1212
Umbrella	832, 1002, 1003, 1004, 1005, 1006, 1007, 1008, 1009, 1010, 1011, 1012, 1013, 1014, 1015
Universal Lenses	1165
USB Ball Pen	98
USB Car Charger	1209
USB Charger	15, 87, 89
USB Chargers Set	1208
USB Hub	8, 10, 11, 12, 16, 17, 59, 61, 90, 91, 92, 1163

NAMES	PAGES
USB Hub	133
Pencil Holder	
USB Memory	61, 93, 94, 95, 96, 97, 1163, 1165
USB Notepad	98
USB Stylus	98, 471
Touch Ball Pen	
UV Meter	1205
UV Sterilizer Lamp	1204
UV Sterilizer Organizer	1172
Vacuum Bottle	279
Vacuum Bottle Stopper	660, 661, 1197
Vacuum Flask	275, 283, 284, 285, 307
Vaporizer	758, 930, 1194
Vaporizer Bottle	317
Vaporizer Fan	930
Vegan Lip Balm	742
Vest	1124, 1126, 1128, 1129, 1130, 1131, 1132, 1139, 1219
Vest	520, 833
Virtual Reality Glasses	111, 1166
Waistbag	237, 238, 254, 256, 514, 1191
Walking Pole	543
Walking Poles Set	543
Wall Clock	46, 50, 106, 1193
Wall Clock Timer	1193
Wallet	680, 1203
Waste Bag Dispenser	841, 1179
Water Fountain	579
Weather Station	47, 48, 49
Weather Station Charger	47
Webcam Cover	119, 1165
Webcam Cover Joystick	1165
Weighing Scales	601, 629, 894
Weighing Scales	894
Weighing Scales Kitchen Cutting Board	591
Whisky Set	610
Whistle	520, 799, 833, 1191
Whiteboard	634, 823, 1190
Wine Aerator	661
Wine and Cheese Knife Set	595, 596
Wine Decanter	611, 658
Wine Set	611, 659, 661, 663, 664, 665, 666, 667
Wineskin	662
Wish Bottle	1146

NAMES	PAGES
Women Colour Polo Shirt	1110
Women Colour Polo Shirt "keya"	1112
Women Colour T-Shirt	1090, 1104, 1106
Women Colour T-Shirt "keya"	1092, 1096
Women Polo Shirt	1216
Women T-Shirt	1076, 1078, 1080, 1087, 1099, 1216
Women T-Shirt "keya"	1100
Women White Polo Shirt	1110
Women White Polo Shirt "keya"	1112
Women White T-Shirt	1090, 1104, 1106
Women White T-Shirt "keya"	1092, 1096
Wristband	519
X-Banner	999
Xylophone	799
Yoga Block	516
Yoyo	813
360° Camera	1162
3D Lens	1165
4 Batteries Pack 1,5V	106
7 in 1 Multifunction Pen	489



Reservados todos los derechos. La información contenida en este documento y/o alguna derivación de sus partes, y/o en conexión con las mismas, no puede ser reproducida ni usada en forma o medio alguno. El uso no sujeto a lo aquí estipulado derivará en la aplicación de las medidas legales que se estimen pertinentes.

All rights reserved. The information contained in the present document and/or any of its derivations and/or in connection with them shall not be reproduced, nor used, in any form or media. A use not subject to the former stipulations should derive in the applying of the legal measures considered appropriate.

Gama de Coiores
Gamme de Couleurs
Farbcodes

COLOR CODES

Gamma di Colori
Gama de Cores
Kleur Codes

01
BLANCO
WHITE
BLANC
WEISS
BIANCO
BRANCO
WIT

02
NEGRO
BLACK
NOIR
SCHWARZ
NERO
PRETO
ZWART

03
ROJO
RED
ROUGE
ROT
ROSSO
VERMELHO
ROOD

04
VERDE
GREEN
VERT
GRÜN
VERDE
VERDE
GRÖEN

05
AMARILLO
YELLOW
JAUNE
GELB
GIALLO
AMARELO
GEEL

19
AZUL
BLUE
BLEU
BLAU
BLU
AZUL
BLAUW

20
BURDEOS
BURGUNDY
BORDEAUX
WEINROT
BORDEAUX
BORDEAUX
BORDEAUX

06
MARINO
NAVY BLUE
BLEU MARINE
DUNKELBLAU
MARINE
AZUL MARINO
MARINE BLAUW

07
NARANJA
ORANGE
ORANGE
ORANGE
ARANCIO
LARANJA
ORANJE

08
GRIS
GREY
GRIS
GRAU
GRIGIO
CINZENTO
GRUJS

09
PLATA
SILVER
ARGENT
SILBER
ARGENTO
PRATA
ZILVER

11
FUCSIA
FUCHSIA
FUCHSIA
FUCHSIE
FUCHSIA
VIOLETA
FUCHSIA

21
AZUL CLARO
LIGHT BLUE
BLEU CLAIR
HELLBLAU
BLU CHIARO
AZUL CLARO
LICHT BLAUW

22
ROSA
PINK
ROSE
ROSA
ROSA
ROSA
ROSE

13
NATURAL
NATURAL
NATUREL
BEIGE
NATURALE
NATURAL
NATUREL

14
KHAKI
KHAKI
KAKI
KHAKI
CACCHI
CAQUI
KHAKI

15
ARENA
SAND
SABLE
SAND
SABBIA
AREIA
ZAND

16
PISTACHO
PISTACHIO
PISTACHE
PISTAZIEN
VERDE ACIDO
PISTACIO
PISTACHE

17
LILA
LILAC
LILAS
LILA
VIOLETA
LILAS
LILA

18
MARRÓN
BROWN
MARRON
BRAUN
MARRONE
CASTANHO
BRUIN

23
DORADO
GOLDEN
DORÉ
GOLD
ORO
DOURADO
GOUW

PASTEL CODES

05 P
AMARILLO
YELLOW
JAUNE
GELB
GIALLO
AMARELO
GEEL

13 P
NATURAL
NATURAL
NATUREL
BEIGE
NATURALE
NATURAL
NATUREL

17 P
LILA
LILAC
LILAS
LILA
VIOLETA
LILAS
LILA

21 P
AZUL CLARO
LIGHT BLUE
BLEU CLAIR
HELLBLAU
BLU CHIARO
AZUL CLARO
LICHT BLAUW

16 P
PISTACHO
PISTACHIO
PISTACHE
PISTAZIEN
VERDE ACIDO
PISTACIO
PISTACHE

FLUORESCENT CODES

11 F
FUCSIA
FUCHSIA
FUCHSIA
FUCHSIE
FUCHSIA
VIOLETA
FUCHSIA

07 F
NARANJA
ORANGE
ORANGE
ORANGE
ARANCIO
LARANJA
ORANJE

05 F
AMARILLO
YELLOW
JAUNE
GELB
GIALLO
AMARELO
GEEL

04 F
VERDE
GREEN
VERT
GRÜN
VERDE
VERDE
GRÖEN

All logos published in this catalogue are only customization examples. They are not subject to commercial profit.
The graphic reproduction of the items in this catalogue may differ in shade or colour from the actual product.



PRESENT-DAY PROMOTIONAL PRODUCTS